



M8/M12 CONNECTOR SYSTEM

TE CONNECTIVITY'S M8 / M12

Connector System for machine industrial automation and control applications provides a solution for the increasing needs of sensor connections that safely and reliably ensures the communication in industrial environments. This connector system also finds applications outside of its traditional industries where a compact reliable connection system with environmental protection is required. TE's solution includes an extensive connector range of PCB headers, cable assemblies and I/O boxes, and provides users with an interface that supports higher bandwidth needs - meeting the requirements of up to 10Gb/s.

TE Connectivity also offers shielded and un-shielded Cat5e and Cat6A cable assembly variants. A predefined offering in length of 1, 3, 5 and 10 meters covers a vast range of customer needs on the market. For rewiring on site a range of field serviceable connectors are provided, allowing versatile systems to be quickly and easily established. Additional styles are available on request including alternative mounting arrangements for panel mount connectors and double ended cable assemblies.



TE'S INDUSTRIAL COMMUNICATIONS PRODUCTS PLAY A VITAL ROLE IN FACTORY AUTOMATION.

TE's industrial Communications products are widespread throughout today's networked factories, and play a critical role in driving the efficiency of many manufacturing processes. Used extensively in material handling equip-

ment, our industrial communications solutions are also found throughout the automotive and food and beverage industries, as well as in the many manufacturing applications of industrial robots. With the development of smaller

industrial Ethernet products, TE's solutions are also ideal for vision systems, common in security equipment and mail sortation devices.

TE M8/M12 CONNECTOR SYSTEM – APPLICATIONS

MACHINERY



FACTORY AUTOMATION



TE's M8/M12 Connector System includes a broad range of straight, angled, LED and multi-position field installable and board connectors that are easily intermateable. Next to cable assemblies for Serial and Bus communication, TE also offers Industrial Ethernet patch cables with overmolded X-coded M12 connectors that are available for future proof applications with up to 10 Gb/s data transmission. Customized cable assemblies offer a solution for your specific needs in different lengths, temperatures or flexibility. When communication simply needs to work in industrial environments, TE's M8/M12 system and complete Industrial Communications portfolio offer proven reliability that meet industry standards. Whether it is for controllers and sensors or robotics and molding machines, the M8/M12 connector system offers you a solution that is time-saving, error-free and without the use of tools.

CONTENTS

| | |
|---|--------|
| CONNECTORS | 5 |
| • M8 Field Installable | 7 |
| • M8 Field Installable – Screw Assy | 8-9 |
| • M12 Straight Field Installable A, B, D Code | 10-11 |
| • M12 Angled Field Installable A, B, D Code | 12-13 |
| • M12 Straight Field Installable | 14-15 |
| • M12 Angled Field Installable | 16-17 |
| • M8 Panel Mount Solder PCB | 18-19 |
| • M8 Panel Mount Wire | 20 |
| • M12 Panel Mount Solder PCB | 21-23 |
| • M12 Panel Mount PCB | 24-25 |
| • M12 Panel Mount Solder Wire | 26-27 |
| • M12 Panel Mount 200 mm Wire | 28-29 |
| • M12 Panel Mount Wire | 30 |
| • M12 X-Coded Field Installable | 31 |
| • Accessories | 32-33 |
| CABLE ASSEMBLIES | 34 |
| • M8 Series Male | 35 |
| • M8 Series Female | 36 |
| • M12 Series Male Straight | 37 |
| • M12 Series Female Straight | 38 |
| • M12 Series Male Angled | 39 |
| • M12 Series Female Angled | 40 |
| • M12 Series Male to Female Y-cables | 41 |
| • M8 Male to M12 Female Series | 41 |
| • M8 Female to M12 Male Series | 41 |
| • M12 Male to M12 Female Series | 42 |
| • M8 Female to M8 Male Series LED | 43 |
| • M12 Female to M12 Male Series LED | 43 |
| • Cable Assembly Notes | 44 |
| I/O MODULES | 45 |
| • M8 – With Cable | 46 |
| • M8 – With M12 Plug Connection | 47 |
| • M8 – For Homerun Connection | 47 |
| • M12 – With Cable | 48 |
| • M12 – With M12/M23 Plug Connection | 48 |
| • M12 – No Cable/With Cable Gland | 49 |
| • I/O Module Notes | 50 |
| • M8/M12 Website | 51 |



M8/M12 CONNECTORS

TE's M8/M12 connectors continues to fill the ongoing needs for sensor connection in Industrial Machinery and Factory Automation. A connection standard for many years, these products also find applications outside of their traditional industries where a compact reliable connection system with environmental protection is required. TE's M8/M12 connector portfolio includes A, B, D, S, T, and X-coded (up to 10 Gb/s) versions to serve various customer needs.

The connectors are also available in shielded and unshielded versions, to support Gigabit Ethernet applications.

M8/M12 - THE CODINGS

A-coding: Actuator-sensor plug connections for DeviceNet, IO link and Profibus



B-coding: Fieldbus connections for Profibus and Interbus



D-coding: Industrial Ethernet, Profinet, Ethernet/IP and EtherCat



S-coding: Motor, Frequency-convertors, motor operated switches, PSUs for Power, 620 V, 12 A



T-coding: Fieldbus comp, passive distribution boxes, motors, PSUs for Power, 63 V, 12 A



X-coding: Cat6A, high-speed 10Gbit rugged industrial Ethernet applications IEC 61076-2-109



Ambient temperature for M8:
-40 °C to 85 °C

Ambient temperature for M12:
-40 °C to 85 °C

Current rating:
4 and 5 pins: 4 A per pin
8 and 12 pins: 2 A per pin

IP rating: IP67/IP68

As specifications vary for different parts, please refer to your TE contact for detailed information.

Application Specifications for M8 M12 Connectors and Cable Assemblies:
114-32127, 114-137008, 114-137144

Product Specifications:
Connectors: 108-3641, 108-19483,
108-106140
X-coded: 108-137008



| Size | Pins | Rated | Maximum Current per pin | Polution grade |
|------|------|-------|-------------------------|----------------|
| M8 | 3 | 60 V | 4 A | 3 |
| M8 | 4 | 30 V | 4 A | 3 |
| M12 | 3 | 250 V | 4 A | 3 |
| M12 | 4 | 250 V | 4 A | 3 |
| M12 | 5 | 125 V | 4 A | 3 |
| M12 | 8 | 60 V | 2 A | 3 |
| M12 | 12 | 30 V | 2 A | 3 |

TE Part Number Definition

M12 Screw type connector PN

T 4 1 1 X X X X XX X - XXX



M8 Field Installable

Male Series



Female Series



All dimensions in mm. Temperature range: -40 to +85 degree.

| TE Part Number | | |
|---|-----|-------------|
| M8 Male Screw Connection, Straight | | |
| 3-Pole | PG7 | 2120954-1 |
| 4-Pole | PG7 | 1-2120954-1 |

| TE Part Number | | |
|----------------------------|-----|-------------|
| M8 Male Right Angle | | |
| 3-Pole | PG7 | 2120955-1 |
| 4-Pole | PG7 | 1-2120955-1 |

| TE Part Number | | |
|---|----|-------------|
| M8 Male Panel, Solder, Front Mounting, M8 Fastening Thread | | |
| 3-Pole | M8 | 2120958-1 |
| 4-Pole | M8 | 1-2120958-1 |

| TE Part Number | | |
|---|-----|-------------|
| M8 Female Screw Connection, Straight | | |
| 3-Pole | PG7 | 2120956-1 |
| 4-Pole | PG7 | 1-2120956-1 |

| TE Part Number | | |
|------------------------------|-----|-------------|
| M8 Female Right Angle | | |
| 3-Pole | PG7 | 2120957-1 |
| 4-Pole | PG7 | 1-2120957-1 |

| TE Part Number | | |
|---|----|-------------|
| M8 Female Panel, Solder, Front Mounting, M8 Fastening Thread | | |
| 3-Pole | M8 | 2120959-1 |
| 4-Pole | M8 | 1-2120959-1 |

M8 Field Installable – Screw Assy Straight

Male Series



Female Series



All dimensions in mm. Temperature range: -40 to +85 degree. Products can also be obtained with silver-plated contacts upon request.

| TE Part Number | |
|---|-----------------|
| M8 Male Screw Connection, Straight, Unshielded | |
| 3-Pole | T4011008031-000 |
| 4-Pole | T4011008041-000 |

| TE Part Number | |
|---|-----------------|
| M8 Male Screw Connection, Straight, Shielded | |
| 3-Pole | T4011019031-000 |
| 4-Pole | T4011019041-000 |

| TE Part Number | |
|---|-----------------|
| M8 Female Screw Connection, Straight, Unshielded | |
| 3-Pole | T4010008031-000 |
| 4-Pole | T4010008041-000 |

| TE Part Number | |
|---|-----------------|
| M8 Female Screw Connection, Straight, Shielded | |
| 3-Pole | T4010019031-000 |
| 4-Pole | T4010019041-000 |

M8 Field Installable – Screw Assy Right Angled

Male Series



Female Series



All dimensions in mm. Temperature range: -40 to +85 degree. Products can also be obtained with silver-plated contacts upon request.

| TE Part Number | |
|---|-----------------|
| M8 Male Right Angled, Unshielded | |
| 3-Pole | T4013008031-000 |
| 4-Pole | T4013008041-000 |

| TE Part Number | |
|---------------------------------------|-----------------|
| M8 Male Right Angled, Shielded | |
| 3-Pole | T4013019031-000 |
| 4-Pole | T4013019041-000 |

| TE Part Number | |
|--|-----------------|
| M8 Female Right Angled Unshielded | |
| 3-Pole | T4012008031-000 |
| 4-Pole | T4012008041-000 |

| TE Part Number | |
|---|-----------------|
| M8 Female Right Angled, Shielded | |
| 3-Pole | T4010019031-000 |
| 4-Pole | T4010019041-000 |

M12 Straight Field Installable A, B, D Code

Male Series



All dimensions in mm. Temperature range: -40 to +85 degree. Products can also be obtained with silver-plated contacts upon request.

| TE Part Number | | |
|---|-----|------------------------|
| A coding – M12 Male Screw Connection, Straight, Unshielded | | |
| 2-Pole | PG7 | T4111001021-000 |
| | PG9 | T4111002021-000 |
| 3-Pole | PG7 | T4111001031-000 |
| | PG9 | T4111002031-000 |
| 4-Pole | PG7 | T4111001041-000 |
| | PG9 | T4111002041-000 |
| 5-Pole | PG7 | T4111001051-000 |
| | PG9 | T4111002051-000 |
| 8-Pole | PG9 | T4111002081-000 |

| TE Part Number | | |
|---|-----|------------------------|
| A coding – M12 Male Screw Connection, Straight, Shielded | | |
| 2-Pole | PG7 | T4111011021-000 |
| | PG9 | T4111012021-000 |
| 3-Pole | PG7 | T4111011031-000 |
| | PG9 | T4111012031-000 |
| 4-Pole | PG7 | T4111011041-000 |
| | PG9 | T4111012041-000 |
| 5-Pole | PG7 | T4111011051-000 |
| | PG9 | T4111012051-000 |
| 8-Pole | PG9 | T4111012081-000 |

| B coding – M12 Male Screw Connection, Straight, Unshielded | | |
|--|-----|------------------------|
| 2-Pole | PG7 | T4111401021-000 |
| | PG9 | T4111402021-000 |
| 3-Pole | PG7 | T4111401031-000 |
| | PG9 | T4111402031-000 |
| 4-Pole | PG7 | T4111401041-000 |
| | PG9 | T4111402041-000 |
| 5-Pole | PG7 | T4111401051-000 |
| | PG9 | T4111402051-000 |

| B coding – M12 Male Screw Connection, Straight, Shielded | | |
|--|-----|------------------------|
| 2-Pole | PG7 | T4111411021-000 |
| | PG9 | T4111412021-000 |
| 3-Pole | PG7 | T4111411031-000 |
| | PG9 | T4111412031-000 |
| 4-Pole | PG7 | T4111411041-000 |
| | PG9 | T4111412041-000 |
| 5-Pole | PG7 | T4111411051-000 |
| | PG9 | T4111412051-000 |

| D coding – M12 Male Screw Connection, Straight, Unshielded | | |
|--|-----|-----------------|
| 2-Pole | PG7 | T4111501021-000 |
| | PG9 | T4111502021-000 |
| 3-Pole | PG7 | T4111501031-000 |
| | PG9 | T4111502031-000 |
| 4-Pole | PG7 | T4111501041-000 |
| | PG9 | T4111502041-000 |
| 5-Pole | PG7 | T4111501051-000 |
| | PG9 | T4111502051-000 |

| D coding – M12 Male Screw Connection, Straight, Shielded | | |
|--|-----|------------------------|
| 2-Pole | PG7 | T4111511021-000 |
| | PG9 | T4111512021-000 |
| 3-Pole | PG7 | T4111511031-000 |
| | PG9 | T4111512031-000 |
| 4-Pole | PG7 | T4111511041-000 |
| | PG9 | T4111512041-000 |
| 5-Pole | PG7 | T4111511051-000 |
| | PG9 | T4111512051-000 |

Female Series

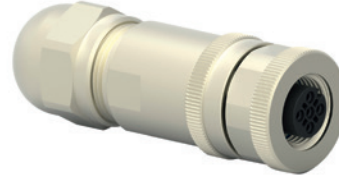
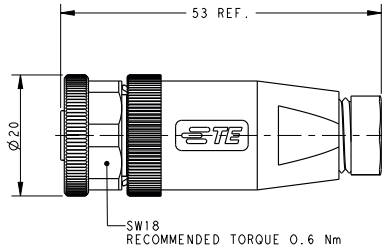

All dimensions in mm. Temperature range: -40 to +85 degree. Products can also be obtained with silver-plated contacts upon request.

| TE Part Number | | |
|---|-----|------------------------|
| A coding – M12 Female Screw Connection, Straight, Unshielded | | |
| 2-Pole | PG7 | T4110001021-000 |
| | PG9 | T4110002021-000 |
| 3-Pole | PG7 | T4110001031-000 |
| | PG9 | T4110002031-000 |
| 4-Pole | PG7 | T4110001041-000 |
| | PG9 | T4110002041-000 |
| 5-Pole | PG7 | T4110001051-000 |
| | PG9 | T4110002051-000 |
| 8-Pole | PG9 | T4110002081-000 |

| TE Part Number | | |
|---|-----|------------------------|
| A coding – M12 Female Screw Connection, Straight, Shielded | | |
| 2-Pole | PG7 | T4110011021-000 |
| | PG9 | T4110012021-000 |
| 3-Pole | PG7 | T4110011031-000 |
| | PG9 | T4110012031-000 |
| 4-Pole | PG7 | T4110011041-000 |
| | PG9 | T4110012041-000 |
| 5-Pole | PG7 | T4110011051-000 |
| | PG9 | T4110012051-000 |
| 8-Pole | PG9 | T4110012081-000 |

| B coding – M12 Female Screw Connection, Straight, Unshielded | | |
|--|-----|------------------------|
| 2-Pole | PG7 | T4110401021-000 |
| | PG9 | T4110402021-000 |
| 3-Pole | PG7 | T4110401031-000 |
| | PG9 | T4110402031-000 |
| 4-Pole | PG7 | T4110401041-000 |
| | PG9 | T4110402041-000 |
| 5-Pole | PG7 | T4110401051-000 |
| | PG9 | T4110402051-000 |

| B coding – M12 Female Screw Connection, Straight, Shielded | | |
|--|-----|------------------------|
| 2-Pole | PG7 | T4110411021-000 |
| | PG9 | T4110412021-000 |
| 3-Pole | PG7 | T4110411031-000 |
| | PG9 | T4110412031-000 |
| 4-Pole | PG7 | T4110411041-000 |
| | PG9 | T4110412041-000 |
| 5-Pole | PG7 | T4110411051-000 |
| | PG9 | T4110412051-000 |

| D coding – M12 Female Screw Connection, Straight, Unshielded | | |
|--|-----|-----------------|
| 2-Pole | PG7 | T4110501021-000 |
| | PG9 | T4110502021-000 |
| 3-Pole | PG7 | T4110501031-000 |
| | PG9 | T4110502031-000 |
| 4-Pole | PG7 | T4110501041-000 |
| | PG9 | T4110502041-000 |
| 5-Pole | PG7 | T4110501051-000 |
| | PG9 | T4110502051-000 |

| D coding – M12 Female Screw Connection, Straight, Shielded | | |
|--|-----|------------------------|
| 2-Pole | PG7 | T4110511021-000 |
| | PG9 | T4110512021-000 |
| 3-Pole | PG7 | T4110511031-000 |
| | PG9 | T4110512031-000 |
| 4-Pole | PG7 | T4110511041-000 |
| | PG9 | T4110512041-000 |
| 5-Pole | PG7 | T4110511051-000 |
| | PG9 | T4110512051-000 |

M12 Angled Field Installable A, B, D Code

Male Series



All dimensions in mm. Temperature range: -40 to +85 degree. Products can also be obtained with silver-plated contacts upon request.

| Temperature range: -25 to +85 | | TE Part Number |
|---|-----|------------------------|
| A coding – M12 Male Screw Connection, Angled, Unshielded | | |
| 2-Pole | PG7 | T4113001021-000 |
| | PG9 | T4113002021-000 |
| 3-Pole | PG7 | T4113001031-000 |
| | PG9 | T4113002031-000 |
| 4-Pole | PG7 | T4113001041-000 |
| | PG9 | T4113002041-000 |
| 5-Pole | PG7 | T4113001051-000 |
| | PG9 | T4113002051-000 |
| 8-Pole | PG9 | T4113002081-000 |

| | | TE Part Number |
|---|-----|------------------------|
| A coding – M12 Male Screw Connection, Angled, Shielded | | |
| 2-Pole | PG7 | T4113011021-000 |
| | PG9 | T4113012021-000 |
| 3-Pole | PG7 | T4113011031-000 |
| | PG9 | T4113012031-000 |
| 4-Pole | PG7 | T4113011041-000 |
| | PG9 | T4113012041-000 |
| 5-Pole | PG7 | T4113011051-000 |
| | PG9 | T4113012051-000 |
| 8-Pole | PG9 | T4113012081-000 |

| B coding – M12 Male Screw Connection, Angled, Unshielded | | |
|---|-----|------------------------|
| 2-Pole | PG7 | T4113401021-000 |
| | PG9 | T4113402021-000 |
| 3-Pole | PG7 | T4113401031-000 |
| | PG9 | T4113402031-000 |
| 4-Pole | PG7 | T4113401041-000 |
| | PG9 | T4113402041-000 |
| 5-Pole | PG7 | T4113401051-000 |
| | PG9 | T4113402051-000 |

| B coding – M12 Male Screw Connection, Angled, Shielded | | |
|---|-----|------------------------|
| 2-Pole | PG7 | T4113411021-000 |
| | PG9 | T4113412021-000 |
| 3-Pole | PG7 | T4113411031-000 |
| | PG9 | T4113412031-000 |
| 4-Pole | PG7 | T4113411041-000 |
| | PG9 | T4113412041-000 |
| 5-Pole | PG7 | T4113411051-000 |
| | PG9 | T4113412051-000 |

| D coding – M12 Male Screw Connection, Angled, Unshielded | | |
|---|-----|-----------------|
| 2-Pole | PG7 | T4113501021-000 |
| | PG9 | T4113502021-000 |
| 3-Pole | PG7 | T4113501031-000 |
| | PG9 | T4113502031-000 |
| 4-Pole | PG7 | T4113501041-000 |
| | PG9 | T4113502041-000 |
| 5-Pole | PG7 | T4113501051-000 |
| | PG9 | T4113502051-000 |

| D coding – M12 Male Screw Connection, Angled, Shielded | | |
|---|-----|------------------------|
| 2-Pole | PG7 | T4113511021-000 |
| | PG9 | T4113512021-000 |
| 3-Pole | PG7 | T4113511031-000 |
| | PG9 | T4113512031-000 |
| 4-Pole | PG7 | T4113511041-000 |
| | PG9 | T4113512041-000 |
| 5-Pole | PG7 | T4113511051-000 |
| | PG9 | T4113512051-000 |

Female Series

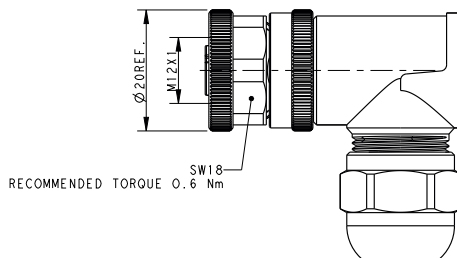
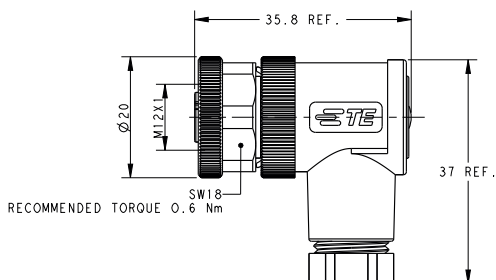

All dimensions in mm. Temperature range: -40 to +85 degree. Products can also be obtained with silver-plated contacts upon request.

| TE Part Number | | |
|---|-----|------------------------|
| A coding – M12 Female Screw Connection, Angled, Unshielded | | |
| 2-Pole | PG7 | T4112001021-000 |
| | PG9 | T4112002021-000 |
| 3-Pole | PG7 | T4112001031-000 |
| | PG9 | T4112002031-000 |
| 4-Pole | PG7 | T4112001041-000 |
| | PG9 | T4112002041-000 |
| 5-Pole | PG7 | T4112001051-000 |
| | PG9 | T4112002051-000 |
| 8-Pole | PG9 | T4112002081-000 |

| TE Part Number | | |
|---|-----|------------------------|
| A coding – M12 Female Screw Connection, Angled, Shielded | | |
| 2-Pole | PG7 | T4112011021-000 |
| | PG9 | T4112012021-000 |
| 3-Pole | PG7 | T4112011031-000 |
| | PG9 | T4112012031-000 |
| 4-Pole | PG7 | T4112011041-000 |
| | PG9 | T4112012041-000 |
| 5-Pole | PG7 | T4112011051-000 |
| | PG9 | T4112012051-000 |
| 8-Pole | PG9 | T4112012081-000 |

| B coding – M12 Female Screw Connection, Angled, Unshielded | | |
|--|-----|------------------------|
| 2-Pole | PG7 | T4112401021-000 |
| | PG9 | T4112402021-000 |
| 3-Pole | PG7 | T4112401031-000 |
| | PG9 | T4112402031-000 |
| 4-Pole | PG7 | T4112401041-000 |
| | PG9 | T4112402041-000 |
| 5-Pole | PG7 | T4112401051-000 |
| | PG9 | T4112402051-000 |

| B coding – M12 Female Screw Connection, Angled, Shielded | | |
|--|-----|------------------------|
| 2-Pole | PG7 | T4112411021-000 |
| | PG9 | T4112412021-000 |
| 3-Pole | PG7 | T4112411031-000 |
| | PG9 | T4112412031-000 |
| 4-Pole | PG7 | T4112411041-000 |
| | PG9 | T4112412041-000 |
| 5-Pole | PG7 | T4112411051-000 |
| | PG9 | T4112412051-000 |

| D coding – M12 Female Screw Connection, Angled, Unshielded | | |
|--|-----|-----------------|
| 2-Pole | PG7 | T4112501021-000 |
| | PG9 | T4112502021-000 |
| 3-Pole | PG7 | T4112501031-000 |
| | PG9 | T4112502031-000 |
| 4-Pole | PG7 | T4112501041-000 |
| | PG9 | T4112502041-000 |
| 5-Pole | PG7 | T4112501051-000 |
| | PG9 | T4112502051-000 |

| D coding – M12 Female Screw Connection, Angled, Shielded | | |
|--|-----|------------------------|
| 2-Pole | PG7 | T4112511021-000 |
| | PG9 | T4112512021-000 |
| 3-Pole | PG7 | T4112511031-000 |
| | PG9 | T4112512031-000 |
| 4-Pole | PG7 | T4112511041-000 |
| | PG9 | T4112512041-000 |
| 5-Pole | PG7 | T4112511051-000 |
| | PG9 | T4112512051-000 |

M12 Straight Field Installable

Male Series



All dimensions in mm. Temperature range: -40 to +85 degree.

| TE Part Number | | |
|---|-----|-------------|
| A coding – M12 Male Screw Connection, Straight | | |
| 3-Pole | PG7 | 2-2271110-1 |
| | PG9 | 2-2271110-2 |
| 4-Pole | PG7 | 3-2271110-1 |
| | PG9 | 3-2271110-2 |
| 5-Pole | PG7 | 4-2271110-1 |
| | PG9 | 4-2271110-2 |
| 8-Pole | PG9 | 5-2271110-2 |
| 12-Pole | PG9 | 6-2271110-2 |

| | | |
|---|-----|-------------|
| B coding – M12 Male Screw Connection, Straight | | |
| 4-Pole | PG7 | 3-2271112-1 |
| | PG9 | 3-2271112-2 |
| 5-Pole | PG7 | 4-2271112-1 |
| | PG9 | 4-2271112-2 |

| TE Part Number | | |
|---|-----|-------------|
| A coding – M12 Male Screw Connection, Straight, Shielded | | |
| 4-Pole | PG7 | 3-2271111-2 |
| 5-Pole | PG7 | 4-2271111-2 |
| 8-Pole | PG7 | 5-2271111-2 |
| 12-Pole | PG9 | 6-2271111-2 |

| | | |
|---|-----|-------------|
| B coding – M12 Male Screw Connection, Straight, Shielded | | |
| 4-Pole | PG7 | 3-2271113-2 |
| 5-Pole | PG7 | 4-2271113-2 |

| | | |
|---|-----|-------------|
| D coding – M12 Male Screw Connection, Straight, Shielded | | |
| 4-Pole | PG7 | 3-2271115-2 |

| | | |
|---|---------|-----------|
| S coding – M12 Male Screw Connection, Straight, Shielded | | |
| 3-Pole | plus PE | 2120951-1 |

| | | |
|---|--|-------------|
| T coding – M12 Male Screw Connection, Straight, Shielded | | |
| 4-Pole | | 3-2172096-2 |

Female Series



All dimensions in mm. Temperature range: -40 to +85 degree.

| TE Part Number | | |
|---|-----|-------------|
| A coding – M12 Female Screw Connection, Straight | | |
| 3-Pole | PG7 | 2-2271116-1 |
| | PG9 | 2-2271116-2 |
| 4-Pole | PG7 | 3-2271116-1 |
| | PG9 | 3-2271116-2 |
| 5-Pole | PG7 | 4-2271116-1 |
| | PG9 | 4-2271116-2 |
| 8-Pole | PG9 | 5-2271116-2 |
| 12-Pole | PG9 | 6-2271116-2 |

| B coding – M12 Female Screw Connection, Straight | | |
|--|-----|-------------|
| 4-Pole | PG7 | 3-2271118-1 |
| | PG9 | 3-2271118-2 |
| 5-Pole | PG7 | 4-2271118-1 |
| | PG9 | 4-2271118-2 |

| TE Part Number | | |
|---|-----|-------------|
| A coding – M12 Female Screw Connection, Straight, Shielded | | |
| 4-Pole | PG9 | 3-2271117-2 |
| 5-Pole | PG9 | 4-2271117-2 |
| 8-Pole | PG9 | 5-2271117-2 |
| 12-Pole | PG9 | 6-2271117-2 |

| B coding – M12 Female Screw Connection, Straight, Shielded | | |
|--|-----|-------------|
| 4-Pole | PG7 | 3-2271119-2 |
| 5-Pole | PG7 | 4-2271119-2 |

| D coding – M12 Female Screw Connection, Straight, Shielded | | |
|--|-----|-------------|
| 4-Pole | PG7 | 3-2271121-2 |

| S coding – M12 Female Screw Connection, Straight, Shielded | | |
|--|---------|-----------|
| 3-Pole | plus PE | 2120950-1 |

| T coding – M12 Female, Screw Connection, Straight, Shielded | | |
|---|--|-------------|
| 4-Pole | | 3-2172097-2 |

M12 Angled Field Installable

Male Series



All dimensions in mm. Temperature range: -40 to +85 degree.

| TE Part Number | | |
|---|-----|-------------|
| A coding – M12 Male Screw Connection, Angled | | |
| 3-Pole | PG7 | 2-2271122-1 |
| | PG9 | 2-2271122-2 |
| 4-Pole | PG7 | 3-2271122-1 |
| | PG9 | 3-2271122-2 |
| 5-Pole | PG7 | 4-2271122-1 |
| | PG9 | 4-2271122-2 |
| 8-Pole | PG9 | 5-2271122-2 |
| 12-Pole | PG9 | 6-2271122-2 |

| B coding – M12 Male Screw Connection, Angled | | |
|--|-----|-------------|
| 4-Pole | PG7 | 3-2271124-1 |
| | PG9 | 3-2271124-2 |
| 5-Pole | PG7 | 4-2271124-1 |
| | PG9 | 4-2271124-2 |

| TE Part Number | | |
|---|-----|-------------|
| A coding – M12 Male Screw Connection, Angled, Shielded | | |
| 4-Pole | PG7 | 3-2271123-2 |
| 5-Pole | PG7 | 4-2271123-2 |
| 8-Pole | PG7 | 5-2271123-2 |
| 12-Pole | PG9 | 6-2271123-2 |

| B coding – M12 Male Screw Connection, Angled, Shielded | | |
|--|-----|-------------|
| 4-Pole | PG7 | 3-2271125-2 |
| 5-Pole | PG7 | 4-2271125-2 |

| D coding – M12 Male Screw Connection, Angled, Shielded | | |
|--|-----|-------------|
| 4-Pole | PG7 | 3-2271127-2 |
| | PG9 | 3-2271133-2 |

Female Series



All dimensions in mm. Temperature range: -40 to +85 degree.

| TE Part Number | | |
|---|-----|-------------|
| A coding – M12 Female Screw Connection, Angled | | |
| 3-Pole | PG7 | 2-2271128-1 |
| | PG9 | 2-2271128-2 |
| 4-Pole | PG7 | 3-2271128-1 |
| | PG9 | 3-2271128-2 |
| 5-Pole | PG7 | 4-2271128-1 |
| | PG9 | 4-2271128-2 |
| 8-Pole | PG9 | 5-2271128-2 |
| 12-Pole | PG9 | 6-2271128-2 |

| | | |
|---|-----|-------------|
| B coding – M12 Female Screw Connection, Angled | | |
| 4-Pole | PG7 | 3-2271130-1 |
| | PG9 | 3-2271130-2 |
| 5-Pole | PG7 | 4-2271130-1 |
| | PG9 | 4-2271130-2 |

| TE Part Number | | |
|---|-----|-------------|
| A coding – M12 Female Screw Connection, Angled, Shielded | | |
| 4-Pole | PG7 | 3-2271129-2 |
| 5-Pole | PG7 | 4-2271129-2 |
| 8-Pole | PG7 | 5-2271129-2 |
| 12-Pole | PG9 | 6-2271129-2 |

| | | |
|---|-----|-------------|
| B coding – M12 Female Screw Connection, Angled, Shielded | | |
| 4-Pole | PG9 | 3-2271131-2 |
| 5-Pole | PG9 | 4-2271131-2 |

| | | |
|---|-----|-------------|
| D coding – M12 Female Screw Connection, Angled, Shielded | | |
| 4-Pole | PG7 | 3-2271133-2 |

M8 Panel Mount Solder PCB

Male Series

Female Series



All dimensions in mm. Temperature range: -40 to +85 degree.

| TE Part Number | |
|---|-------------|
| M8, Male, Rear Mount, PCB, R/A, Unshielded | |
| 3-Pole | 2-2172067-2 |
| 4-Pole | 3-2172067-2 |

| TE Part Number | |
|---|-------------|
| M8, Female, Rear Mount, PCB, R/A, Unshielded | |
| 3-Pole | 2-2172068-2 |
| 4-Pole | 3-2172068-2 |

| TE Part Number | |
|---|-------------|
| M8, Male, Rear Mount, PCB, R/A, Shielded | |
| 3-Pole | 2-2172093-2 |
| 4-Pole | 3-2172093-2 |

| TE Part Number | |
|---|-------------|
| M8, Female, Rear Mount, PCB, R/A, Shielded | |
| 3-Pole | 2-2172091-2 |
| 4-Pole | 3-2172091-2 |

Male Series



Female Series



All dimensions in mm. Temperature range: -40 to +85 degree.

| TE Part Number | |
|--|-------------|
| M8, Male, Rear Mount, PCB, Straight, Unshielded | |
| 4-Pole | 3-2172069-2 |

| TE Part Number | |
|--|-------------|
| M8, Male, Rear Mount, PCB, Straight, Shielded | |
| 3-Pole | 2-2172092-2 |
| 4-Pole | 3-2172092-2 |

| TE Part Number | |
|--|-------------|
| M8, Female, Rear Mount, PCB, Straight, Shielded | |
| 3-Pole | 2-2172089-2 |
| 4-Pole | 3-2172089-2 |

M8 Panel Mount Wire

Male Series



Female Series



All dimensions in mm. Temperature range: -40 to +85 degree.

| TE Part Number | |
|---|-------------|
| M8, Male, Rear Mount, Wire, Straight | |
| 3-Pole | 2-2172090-2 |
| 4-Pole | 3-2172090-2 |

| TE Part Number | |
|---|-------------|
| M8, Female, Rear Mount, Wire, Straight | |
| 3-Pole | 2-2172088-2 |
| 4-Pole | 3-2172088-2 |

M12 Panel Mount Solder PCB

Male Series

Female Series



All dimensions in mm. Temperature range: -40 to +85 degree.

| TE Part Number | | |
|--|-----|-------------|
| A coding | | |
| M12 Male, Rear Mounting M16 x 1.5, Straight | | |
| 4-Pole | PG9 | 3-2271140-2 |
| 5-Pole | PG9 | 4-2271140-2 |
| 8-Pole | PG9 | 5-2271140-2 |
| 12-Pole | PG9 | 6-2271140-2 |

| TE Part Number | | |
|--|-----|-------------|
| A coding | | |
| M12 Female, Rear Mounting M16 x 1.5, Straight | | |
| 4-Pole | PG9 | 3-2271143-2 |
| 5-Pole | PG9 | 4-2271143-2 |
| 8-Pole | PG9 | 5-2271143-2 |
| 12-Pole | PG9 | 6-2271143-2 |

| | | |
|--|-----|-------------|
| B coding | | |
| M12 Male, Rear Mounting M16 x 1.5, Straight | | |
| 4-Pole | PG9 | 3-2271141-2 |
| 5-Pole | PG9 | 4-2271141-2 |

| | | |
|--|-----|-------------|
| B coding | | |
| M12 Female, Rear Mounting M16 x 1.5, Straight | | |
| 4-Pole | PG9 | 3-2271144-2 |
| 5-Pole | PG9 | 4-2271144-2 |

| | | |
|--|-----|-------------|
| D coding | | |
| M12 Male, Rear Mounting M16 x 1.5, Straight | | |
| 4-Pole | PG9 | 3-2271142-2 |

| | | |
|--|-----|-------------|
| D coding | | |
| M12 Female, Rear Mounting M16 x 1.5, Straight | | |
| 4-Pole | PG9 | 3-2271145-2 |

M12 Panel Mount Solder PCB

Male Series



All dimensions in mm. Temperature range: -40 to +85 degree.

| TE Part Number | |
|---|-------------|
| A coding – M12, Male, Rear Mount, PCB, R/A, Unshielded | |
| 4-Pole | 3-2172062-2 |
| 5-Pole | 4-2172062-2 |

| TE Part Number | |
|---|-------------|
| A coding – M12, Male, Rear Mount, PCB, R/A, Shielded | |
| 4-Pole (45 degrees) | 3-2172094-2 |
| 4-Pole | 3-2172081-2 |
| 5-Pole | 4-2172081-2 |
| 8-Pole | 5-2172081-2 |

| TE Part Number | |
|--|-------------|
| A coding – M12, Male, Rear Mount, PCB, Straight, Unshielded | |
| 4-Pole | 3-2172070-2 |
| 5-Pole | 4-2172070-2 |
| 8-Pole | 5-2172070-2 |

| TE Part Number | |
|--|-------------|
| A coding – M12, Male, Rear Mount, PCB, Straight, Shielded | |
| 4-Pole | 3-2172080-2 |
| 5-Pole | 4-2172080-2 |
| 8-Pole | 5-2172080-2 |

| TE Part Number | |
|---|-------------|
| B coding – M12, Male, Rear Mount, PCB, R/A, Unshielded | |
| 5-Pole | 4-2172082-2 |

| TE Part Number | |
|---|-------------|
| B coding – M12, Male, Rear Mount, PCB, R/A, Shielded | |
| 5-Pole | 4-2172063-2 |

| TE Part Number | |
|--|-------------|
| B coding – M12, Male, Rear Mount, PCB, Straight, Shielded | |
| 5-Pole | 4-2172073-2 |

| TE Part Number | |
|---|-------------|
| D coding – M12, Male, Rear Mount, PCB, R/A, Unshielded | |
| 4-Pole | 3-2172086-2 |

| TE Part Number | |
|---|-------------|
| D coding – M12, Male, Rear Mount, PCB, R/A, Shielded | |
| 4-Pole | 3-2172065-2 |

| TE Part Number | |
|--|-------------|
| D coding – M12, Male, Rear Mount, PCB, Straight, Shielded | |
| 4-Pole | 3-2172084-2 |

Female Series



All dimensions in mm. Temperature range: -40 to +85 degree.

| TE Part Number | |
|---|-------------|
| A coding – M12, Female, Rear Mount, PCB, R/A, Unshielded | |
| 4-Pole | 3-2172072-2 |
| 5-Pole | 4-2172072-2 |

| TE Part Number | |
|---|-------------|
| A coding – M12, Female, Rear Mount, PCB, R/A, Shielded | |
| 4-Pole (45 degrees) | 3-2172095-2 |
| 4-Pole | 3-2172079-2 |
| 5-Pole | 4-2172079-2 |
| 8-Pole | 5-2172079-2 |

| TE Part Number | |
|--|-------------|
| A coding – M12, Female, Rear Mount, PCB, Straight, Unshielded | |
| 4-Pole | 3-2172071-2 |
| 5-Pole | 4-2172071-2 |
| 8-Pole | 5-2172071-2 |

| TE Part Number | |
|--|-------------|
| A coding – M12, Female, Rear Mount, PCB, Straight, Shielded | |
| 4-Pole | 3-2172078-2 |
| 5-Pole | 4-2172078-2 |
| 8-Pole | 5-2172078-2 |

| TE Part Number | |
|---|-------------|
| B coding – M12, Female, Rear Mount, PCB, R/A, Unshielded | |
| 5-Pole | 4-2172083-2 |

| TE Part Number | |
|---|-------------|
| B coding – M12, Female, Rear Mount, PCB, R/A, Shielded | |
| 5-Pole | 4-2172064-2 |

| TE Part Number | |
|--|-------------|
| B coding – M12, Female, Rear Mount, PCB, Straight, Shielded | |
| 5-Pole | 4-2172074-2 |

| TE Part Number | |
|---|-------------|
| D coding – M12, Female, Rear Mount, PCB, R/A, Unshielded | |
| 4-Pole | 3-2172087-2 |

| TE Part Number | |
|---|-------------|
| D coding – M12, Female, Rear Mount, PCB, R/A, Shielded | |
| 4-Pole | 3-2172066-2 |

| TE Part Number | |
|--|-------------|
| D coding – M12, Female, Rear Mount, PCB, Straight, Shielded | |
| 4-Pole | 3-2172085-2 |

M12 Panel Mount PCB – Rear Mounting

Male Series



Female Series



All dimensions in mm. Temperature range: -40 to +85 degree.

| TE Part Number | |
|---|-----------------|
| A coding – M12 Male, Rear Mounting, Straight | |
| 2-Pole | T4140012021-000 |
| 3-Pole | T4140012031-000 |
| 4-Pole | T4140012041-000 |
| 5-Pole | T4140012051-000 |

| TE Part Number | |
|---|-----------------|
| B coding – M12 Male, Rear Mounting, Straight | |
| 2-Pole | T4140412021-000 |
| 3-Pole | T4140412031-000 |
| 4-Pole | T4140412041-000 |
| 5-Pole | T4140412051-000 |

| TE Part Number | |
|---|-----------------|
| D coding – M12 Male, Rear Mounting, Straight | |
| 2-Pole | T4140512021-000 |
| 3-Pole | T4140512031-000 |
| 4-Pole | T4140512041-000 |
| 5-Pole | T4140512051-000 |

| TE Part Number | |
|---|-----------------|
| A coding – M12 Female, Rear Mounting, Straight | |
| 2-Pole | T4141012021-000 |
| 3-Pole | T4141012031-000 |
| 4-Pole | T4141012041-000 |
| 5-Pole | T4141012051-000 |

| TE Part Number | |
|---|-----------------|
| B coding – M12 Female, Rear Mounting, Straight | |
| 2-Pole | T4141412021-000 |
| 3-Pole | T4141412031-000 |
| 4-Pole | T4141412041-000 |
| 5-Pole | T4141412051-000 |

| TE Part Number | |
|---|-----------------|
| D coding – M12 Female, Rear Mounting, Straight | |
| 2-Pole | T4141512021-000 |
| 3-Pole | T4141512031-000 |
| 4-Pole | T4141512041-000 |
| 5-Pole | T4141512051-000 |

M12 Panel Mount PCB – Front Mounting

Male Series



Female Series



All dimensions in mm. Temperature range: -40 to +85 degree.

| TE Part Number | |
|--|-----------------|
| A coding – M12 Male, Front Mounting, Straight | |
| 2-Pole | T4142012021-000 |
| 3-Pole | T4142012031-000 |
| 4-Pole | T4142012041-000 |
| 5-Pole | T4142012051-000 |

| TE Part Number | |
|--|-----------------|
| B coding – M12 Male, Front Mounting, Straight | |
| 2-Pole | T4142412021-000 |
| 3-Pole | T4142412031-000 |
| 4-Pole | T4142412041-000 |
| 5-Pole | T4142412051-000 |

| TE Part Number | |
|--|-----------------|
| D coding – M12 Male, Front Mounting, Straight | |
| 2-Pole | T4142512021-000 |
| 3-Pole | T4142512031-000 |
| 4-Pole | T4142512041-000 |
| 5-Pole | T4142512051-000 |

| TE Part Number | |
|--|-----------------|
| A coding – M12 Female, Front Mounting, Straight | |
| 2-Pole | T4143012021-000 |
| 3-Pole | T4143012031-000 |
| 4-Pole | T4143012041-000 |
| 5-Pole | T4143012051-000 |

| TE Part Number | |
|--|-----------------|
| B coding – M12 Female, Front Mounting, Straight | |
| 2-Pole | T4143412021-000 |
| 3-Pole | T4143412031-000 |
| 4-Pole | T4143412041-000 |
| 5-Pole | T4143412051-000 |

| TE Part Number | |
|--|-----------------|
| D coding – M12 Female, Front Mounting, Straight | |
| 2-Pole | T4143512021-000 |
| 3-Pole | T4143512031-000 |
| 4-Pole | T4143512041-000 |
| 5-Pole | T4143512051-000 |

M12 Panel Mount Solder Wire – Rear Mounting

Male Series



Female Series



All dimensions in mm. Temperature range: -40 to +85 degree.

| TE Part Number | |
|--|-----------------|
| A coding – M12 Male, Rear Mounting, PCB | |
| 2-Pole | T4130012021-000 |
| 3-Pole | T4130012031-000 |
| 4-Pole | T4130012041-000 |
| 5-Pole | T4130012051-000 |

| TE Part Number | |
|--|-----------------|
| B coding – M12 Male, Rear Mounting, PCB | |
| 2-Pole | T4130412021-000 |
| 3-Pole | T4130412031-000 |
| 4-Pole | T4130412041-000 |
| 5-Pole | T4130412051-000 |

| TE Part Number | |
|--|-----------------|
| D coding – M12 Male, Rear Mounting, PCB | |
| 2-Pole | T4130512021-000 |
| 3-Pole | T4130512031-000 |
| 4-Pole | T4130512041-000 |
| 5-Pole | T4130512051-000 |

| TE Part Number | |
|--|-----------------|
| A coding – M12 Female, Rear Mounting, PCB | |
| 2-Pole | T4131012021-000 |
| 3-Pole | T4131012031-000 |
| 4-Pole | T4131012041-000 |
| 5-Pole | T4131012051-000 |

| TE Part Number | |
|--|-----------------|
| B coding – M12 Female, Rear Mounting, PCB | |
| 2-Pole | T4131412021-000 |
| 3-Pole | T4131412031-000 |
| 4-Pole | T4131412041-000 |
| 5-Pole | T4131412051-000 |

| TE Part Number | |
|--|-----------------|
| D coding – M12 Female, Rear Mounting, PCB | |
| 2-Pole | T4131512021-000 |
| 3-Pole | T4131512031-000 |
| 4-Pole | T4131512041-000 |
| 5-Pole | T4131512051-000 |

M12 Panel Mount Solder Wire – Front Mounting

Male Series



Female Series



All dimensions in mm. Temperature range: -40 to +85 degree.

| TE Part Number | |
|---|-----------------|
| A coding – M12 Male, Front Mounting, PCB | |
| 2-Pole | T4132012021-000 |
| 3-Pole | T4132012031-000 |
| 4-Pole | T4132012041-000 |
| 5-Pole | T4132012051-000 |

| TE Part Number | |
|---|-----------------|
| B coding – M12 Male, Front Mounting, PCB | |
| 2-Pole | T4132412021-000 |
| 3-Pole | T4132412031-000 |
| 4-Pole | T4132412041-000 |
| 5-Pole | T4132412051-000 |

| TE Part Number | |
|---|-----------------|
| D coding – M12 Male, Front Mounting, PCB | |
| 2-Pole | T4132512021-000 |
| 3-Pole | T4132512031-000 |
| 4-Pole | T4132512041-000 |
| 5-Pole | T4132512051-000 |

| TE Part Number | |
|---|-----------------|
| A coding – M12 Female, Front Mounting, PCB | |
| 2-Pole | T4133012021-000 |
| 3-Pole | T4133012031-000 |
| 4-Pole | T4133012041-000 |
| 5-Pole | T4133012051-000 |

| TE Part Number | |
|---|-----------------|
| B coding – M12 Female, Front Mounting, PCB | |
| 2-Pole | T4133412021-000 |
| 3-Pole | T4133412031-000 |
| 4-Pole | T4133412041-000 |
| 5-Pole | T4133412051-000 |

| TE Part Number | |
|---|-----------------|
| D coding – M12 Female, Front Mounting, PCB | |
| 2-Pole | T4133512021-000 |
| 3-Pole | T4133512031-000 |
| 4-Pole | T4133512041-000 |
| 5-Pole | T4133512051-000 |

M12 Panel Mount 200mm Wire – Rear Mounting

Male Series



Female Series



All dimensions in mm. Temperature range: -40 to +85 degree.

| TE Part Number | |
|---|-----------------|
| A coding – M12 Male, Rear Mounting, 200mm wire | |
| 2-Pole | T4171010002-001 |
| 3-Pole | T4171010003-001 |
| 4-Pole | T4171010004-001 |
| 5-Pole | T4171010005-001 |

| B coding – M12 Male, Rear Mounting, 200mm wire | |
|--|-----------------|
| 2-Pole | T4171010402-001 |
| 3-Pole | T4171010403-001 |
| 4-Pole | T4171010404-001 |
| 5-Pole | T4171010405-001 |

| D coding – M12 Male, Rear Mounting, 200mm wire | |
|--|-----------------|
| 2-Pole | T4171010502-001 |
| 3-Pole | T4171010503-001 |
| 4-Pole | T4171010504-001 |
| 5-Pole | T4171010505-001 |

| TE Part Number | |
|---|-----------------|
| A coding – M12 Female, Rear Mounting, 200mm wire | |
| 2-Pole | T4171110002-001 |
| 3-Pole | T4171110003-001 |
| 4-Pole | T4171110004-001 |
| 5-Pole | T4171110005-001 |

| B coding – M12 Female, Rear Mounting, 200mm wire | |
|--|-----------------|
| 2-Pole | T4171110402-001 |
| 3-Pole | T4171110403-001 |
| 4-Pole | T4171110404-001 |
| 5-Pole | T4171110405-001 |

| D coding – M12 Female, Rear Mounting, 200mm wire | |
|--|-----------------|
| 2-Pole | T4171110502-001 |
| 3-Pole | T4171110503-001 |
| 4-Pole | T4171110504-001 |
| 5-Pole | T4171110505-001 |

M12 Panel Mount 200mm Wire – Front Mounting

Male Series

Female Series



All dimensions in mm. Temperature range: -40 to +85 degree.

| TE Part Number | |
|--|-----------------|
| A coding – M12 Male, Front Mounting, 200mm wire | |
| 2-Pole | T4171210002-001 |
| 3-Pole | T4171210003-001 |
| 4-Pole | T4171210004-001 |
| 5-Pole | T4171210005-001 |

| | |
|--|-----------------|
| B coding – M12 Male, Front Mounting, 200mm wire | |
| 2-Pole | T4171210402-001 |
| 3-Pole | T4171210403-001 |
| 4-Pole | T4171210404-001 |
| 5-Pole | T4171210405-001 |

| | |
|--|-----------------|
| D coding – M12 Male, Front Mounting, 200mm wire | |
| 2-Pole | T4171210502-001 |
| 3-Pole | T4171210503-001 |
| 4-Pole | T4171210504-001 |
| 5-Pole | T4171210505-001 |

| TE Part Number | |
|--|-----------------|
| A coding – M12 Female, Front Mounting, 200mm wire | |
| 2-Pole | T4171310002-001 |
| 3-Pole | T4171310003-001 |
| 4-Pole | T4171310004-001 |
| 5-Pole | T4171310005-001 |

| | |
|--|-----------------|
| B coding – M12 Female, Front Mounting, 200mm wire | |
| 2-Pole | T4171310402-001 |
| 3-Pole | T4171310403-001 |
| 4-Pole | T4171310404-001 |
| 5-Pole | T4171310405-001 |

| | |
|--|-----------------|
| D coding – M12 Female, Front Mounting, 200mm wire | |
| 2-Pole | T4171310502-001 |
| 3-Pole | T4171310503-001 |
| 4-Pole | T4171310504-001 |
| 5-Pole | T4171310505-001 |

M12 Panel Mount Wire

Male Series



Female Series



All dimensions in mm. Temperature range: -40 to +85 degree.

| TE Part Number | | |
|--|--|-------------|
| A coding | | |
| M12 Male, Front Mounting M16 x 1.5 with wires 0.25 200 mm | | |
| 4-Pole | | 3-2271134-2 |
| 5-Pole | | 4-2271134-2 |
| 8-Pole | | 5-2271134-2 |
| 12-Pole | | 6-2271134-2 |

| | | |
|--|--|-------------|
| B coding | | |
| M12 Male, Front Mounting M16 x 1.5 with wires 0.25 200 mm | | |
| 4-Pole | | 3-2271135-2 |
| 5-Pole | | 4-2271135-2 |

| | | |
|--|-----|-------------|
| D coding | | |
| M12 Male, Front Mounting M16 x 1.5 with wires 0.25 200 mm | | |
| 4-Pole | PG9 | 3-2271136-2 |

| | | |
|---|--|-----------|
| T coding | | |
| M12 Male, Front Mounting M20 x 1.5 | | |
| 4-Pole | | 2120947-1 |

| TE Part Number | | |
|--|--|-------------|
| A coding | | |
| M12 Female, Front Mounting M16 x 1.5 with wires 0.25 200 mm | | |
| 4-Pole | | 3-2271137-2 |
| 5-Pole | | 4-2271137-2 |
| 8-Pole | | 5-2271137-2 |
| 12-Pole | | 6-2271137-2 |

| | | |
|--|--|-------------|
| B coding | | |
| M12 Female, Front Mounting M16 x 1.5 with wires 0.25 200 mm | | |
| 4-Pole | | 3-2271138-2 |
| 5-Pole | | 4-2271138-2 |

| | | |
|--|--|-------------|
| D coding | | |
| M12 Female, Front Mounting M16 x 1.5 with wires 0.25 200 mm | | |
| 4-Pole | | 3-2271139-2 |

| | | |
|--|---------|-------------|
| S coding | | |
| M12 Female, Panel Mount M12 x 1, Screw Connection | | |
| 3-Pole | Plus PE | 3-2823647-2 |

| | | |
|---|--|-----------|
| T coding | | |
| M12 Female, Front Mounting M20 x 1.5 | | |
| 4-Pole | | 2120946-1 |

M12 X-Coded

M12 X-Coded PCB Connector



M12 Pin Connector Cable Assembly

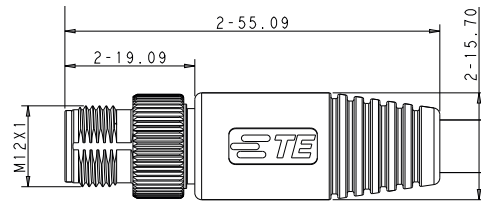

All dimensions in mm. Temperature range: -40 to +85 degree.

| Description | TE Part Number |
|---|----------------|
| M12 X-Coded PCB Connector | |
| Female Panel Mount Solder PCB Connector | 2232331-1 |
| Female Panel Mount Solder Wire | 2271195-1 |

| | |
|---|-----------|
| M12 X-Coded Field Installable Connector | |
| Male Connector installable (IDC): 5.5-9mm cable diameter | 2120952-1 |

| Length | TE Part Number |
|---|----------------|
| M12 Pin Connector Cable Assembly | |
| 1m | 2241021-1 |
| 2m | 2241021-2 |
| 3m | 2241021-3 |
| 4m | 2241021-4 |
| 5m | 2241021-5 |
| 10m | 2241021-6 |

Accessories

Dust Caps



2823563-1



2823064-1



2823065-1



All dimensions in mm. Temperature range: -40 to +85 degree.

| Dust Caps | | TE Part Number |
|---|--|----------------|
| M8, Dust Cap, Female, IP67, without sleeve | | 2823563-1 |
| M12, Dust Cap, Female, IP67, without sleeve | | 2823064-1 |
| M12, Dust Cap, Female, IP67, with sleeve | | 2823065-1 |

Nuts for Panel Mount connectors



2823423-1



2823066-1



All dimensions in mm.

| Nuts for Panel Mount connectors | | TE Part Number |
|-----------------------------------|--|----------------|
| Nut for M8 Panel Mount connector | | 2823423-1 |
| Nut for M12 Panel Mount connector | | 2823066-1 |

M8/M12 CABLE ASSEMBLIES

TE's M8/M12 cable assemblies are available as single-ended or double-ended and as straight or angled versions. Various cable types, colors and lengths offer a flexible design that can be used in combination with TE's male/female connectors and I/O Modules.

Standard (IEC):

IEC 61076-2-104 for all M8 series and
IEC 61076-2-101 for all M12 series

Operating temperature:

Connectors: -25°C to +85°C

Cables:

- PVC: -5°C to +80°C Flexible
-30°C to +80°C Fixed
- PUR: -25°C to +80°C (90°C max. 10.000h) Flexible
-40°C to +80°C (90°C max. 10.000h) Fixed

Connector Contacts:

Current rating per contact is 4 A

Shielding: Yes/No

Refer to drawing

Suitable Cable Diameter:

Refer to drawing

IP Rating:

IP65/67

Application Areas:

- PUR: For use in demanding environments with required resistance to oils, chemicals and abrasion
- PUR/PVC: For use assembly and production lines requiring higher cut, abrasion and chemical resistance
- PVC: For use in less demanding environments with required oil, chemical and lubricant resistance



M8 Cable Assemblies

M8 Series Male

| TE Part Number | Description | Available In |
|----------------|--------------------------------|---|
| 2273000 | M8 x 1.0 Straight plug Pigtail | 3 positions PUR or PVC, Lengths: 1.5m / 3.0m / 5.0m / 10.0m |
| 2273002 | M8 x 1.0 Straight plug Pigtail | 4 positions PUR or PVC, Lengths: 1.5m / 3.0m / 5.0m / 10.0m |



| TE Part Number | Description | Available In |
|----------------|---|---|
| 2273004 | M8 x 1.0 Straight plug Pigtail Shielded | 3 positions PUR or PVC, Lengths: 1.5m / 3.0m / 5.0m / 10.0m |
| 2273006 | M8 x 1.0 Straight plug Pigtail | 4 positions PUR or PVC, Lengths: 1.5m / 3.0m / 5.0m / 10.0m |



| TE Part Number | Description | Available In |
|----------------|------------------------------|---|
| 2273008 | M8 x 1.0 Angled plug Pigtail | 3 positions PUR or PVC, Lengths: 1.5m / 3.0m / 5.0m / 10.0m |
| 2273010 | M8 x 1.0 Angled plug Pigtail | 4 positions PUR or PVC, Lengths: 1.5m / 3.0m / 5.0m / 10.0m |



| TE Part Number | Description | Available In |
|----------------|--------------------------|--|
| 2273014 | M8 Male Panel Mount Rear | 3 positions Panel Mount, Lengths: 0.2m |
| 2273230 | M8 Male Panel Mount Rear | 4 positions Panel Mount, Length: 0.2m |



M8 Cable Assemblies

M8 Series Female

| TE Part Number | Description | Available In |
|----------------|----------------------------------|---|
| 2273001 | M8 x 1.0 Straight socket Pigtail | 3 and 4 positions PUR or PVC, Lengths: 1.5 m / 3.0 m / 5.0 m / 10.0 m |



| TE Part Number | Description | Available In |
|----------------|---|---|
| 2273005 | M8 x 1.0 Straight socket Pigtail Shielded | 3 and 4 positions PUR or PVC, Lengths: 1.5 m / 3.0 m / 5.0 m / 10.0 m |



| TE Part Number | Description | Available In |
|----------------|--------------------------------|---|
| 2273009 | M8 x 1.0 Angled socket Pigtail | 3 and 4 positions PUR or PVC, Lengths: 1.5 m / 3.0 m / 5.0 m / 10.0 m |



| TE Part Number | Description | Available In |
|----------------|------------------------------------|---|
| 2273012 | M8 x 1.0 Angled socket Pigtail LED | 4 positions PUR or PVC, Lengths: 1.5 m / 3.0 m / 5.0 m / 10.0 m |



| TE Part Number | Description | Available In |
|----------------|----------------------------|--|
| 2273013 | M8 Female Panel Mount Rear | 3 positions Panel Mount, Length: 0.2 m |
| 2273015 | M8 Female Panel Mount Rear | 4 positions Panel Mount, Length: 0.2 m |



M12 Cable Assemblies

M12 Series Male Straight

| TE Part Number | Description | Available In |
|----------------|--|---|
| 2273022 | M12 x 1.0 Straight plug Pigtail Unshielded | 3 positions PUR or PVC, Lengths: 1.5 m / 3.0 m / 5.0 m / 10.0 m |
| 2273028 | M12 x 1.0 Straight plug Pigtail Unshielded | 4 positions PUR or PVC, Lengths: 1.5 m / 3.0 m / 5.0 m / 10.0 m |
| 2273034 | M12 x 1.0 Straight plug Pigtail Unshielded | 5 positions PUR or PVC, Lengths: 1.5 m / 3.0 m / 5.0 m / 10.0 m |
| 2273040 | M12 x 1.0 Straight plug Pigtail Unshielded | 8 positions PUR, Lengths: 1.5 m / 3.0 m / 5.0 m / 10.0 m |



| TE Part Number | Description | Available In |
|----------------|--|---|
| 2273042 | M12 x 1.0 Straight plug Pigtail Shielded | 3 positions PUR or PVC, Lengths: 1.5 m / 3.0 m / 5.0 m / 10.0 m |
| 2273044 | M12 x 1.0 Straight plug Pigtail Shielded | 4 positions PUR or PVC, Lengths: 1.5 m / 3.0 m / 5.0 m / 10.0 m |
| 2273046 | M12 x 1.0 Straight plug Pigtail Shielded | 5 positions PUR or PVC, Lengths: 1.5 m / 3.0 m / 5.0 m / 10.0 m |
| 2273048 | M12 x 1.0 Straight plug Pigtail Shielded | 8 positions PUR, Lengths: 1.5 m / 3.0 m / 5.0 m / 10.0 m |



| TE Part Number | Description | Available In |
|----------------|---------------------------|---------------------------------|
| 2273051 | M12 Male Panel Mount Rear | 4 positions PVC, Lengths: 0.2 m |
| 2273052 | M12 Male Panel Mount Rear | 5 positions PVC, Length: 0.2 m |



M12 Cable Assemblies

M12 Series Female Straight

| TE Part Number | Description | Available In |
|----------------|--|---|
| 2273023 | M12 x 1.0 Straight socket Pigtail Unshielded | 3 positions PUR or PVC, Lengths: 1.5 m / 3.0 m / 5.0 m / 10.0 m |
| 2273029 | M12 x 1.0 Straight socket Pigtail Unshielded | 4 positions PUR or PVC, Lengths: 1.5 m / 3.0 m / 5.0 m / 10.0 m |
| 2273035 | M12 x 1.0 Straight socket Pigtail Unshielded | 5 positions PUR or PVC, Lengths: 1.5 m / 3.0 m / 5.0 m / 10.0 m |
| 2273041 | M12 x 1.0 Straight socket Pigtail Unshielded | 8 positions PUR, Lengths: 1.5 m / 3.0 m / 5.0 m / 10.0 m |



| TE Part Number | Description | Available In |
|----------------|--|---|
| 2273043 | M12 x 1.0 Straight socket Pigtail Shielded | 3 positions PUR or PVC, Lengths: 1.5 m / 3.0 m / 5.0 m / 10.0 m |
| 2273045 | M12 x 1.0 Straight socket Pigtail Shielded | 4 positions PUR or PVC, Lengths: 1.5 m / 3.0 m / 5.0 m / 10.0 m |
| 2273047 | M12 x 1.0 Straight socket Pigtail Shielded | 5 positions PUR or PVC, Lengths: 1.5 m / 3.0 m / 5.0 m / 10.0 m |
| 2273049 | M12 x 1.0 Straight socket Pigtail Shielded | 8 positions PUR, Lengths: 1.5 m / 3.0 m / 5.0 m / 10.0 m |



| TE Part Number | Description | Available In |
|----------------|-----------------------------|--------------------------------|
| 2273054 | M12 Female Panel Mount Rear | 4 positions PUR, Length: 0.2 m |
| 2273055 | M12 Female Panel Mount Rear | 5 positions PUR, Length: 0.2 m |



M12 Series Male Angled

| TE Part Number | Description | Available In |
|----------------|--|---|
| 2273076 | M12 x 1.0 Angled plug Pigtail Unshielded | 3 positions PUR or PVC, Lengths: 1.5m / 3.0m / 5.0m / 10.0m |
| 2273082 | M12 x 1.0 Angled plug Pigtail Unshielded | 4 positions PUR or PVC, Lengths: 1.5m / 3.0m / 5.0m / 10.0m |
| 2273088 | M12 x 1.0 Angled plug Pigtail Unshielded | 5 positions PUR or PVC, Lengths: 1.5m / 3.0m / 5.0m / 10.0m |
| 2273094 | M12 x 1.0 Angled plug Pigtail Unshielded | 8 positions PUR, Lengths: 1.5m / 3.0m / 5.0m / 10.0m |



VIEW 'A'



A-coded

| TE Part Number | Description | Available In |
|----------------|--|---|
| 2273096 | M12 x 1.0 Angled plug Pigtail Shielded | 3 positions PUR or PVC, Lengths: 1.5m / 3.0m / 5.0m / 10.0m |
| 2273098 | M12 x 1.0 Angled plug Pigtail Shielded | 4 positions PUR or PVC, Lengths: 1.5m / 3.0m / 5.0m / 10.0m |
| 2273100 | M12 x 1.0 Angled plug Pigtail Shielded | 5 positions PUR or PVC, Lengths: 1.5m / 3.0m / 5.0m / 10.0m |
| 2273102 | M12 x 1.0 Angled plug Pigtail Shielded | 8 positions PUR, Lengths: 1.5m / 3.0m / 5.0m / 10.0m |



VIEW 'A'



A-coded

M12 Cable Assemblies

M12 Series Female Angled

| TE Part Number | Description | Available In |
|----------------|--|---|
| 2273077 | M12 x 1.0 Angled socket Pigtail Unshielded | 3 positions PUR or PVC, Lengths: 1.5m / 3.0m / 5.0m / 10.0m |
| 2273083 | M12 x 1.0 Angled socket Pigtail Unshielded | 4 positions PUR or PVC, Lengths: 1.5m / 3.0m / 5.0m / 10.0m |
| 2273089 | M12 x 1.0 Angled socket Pigtail Unshielded | 5 positions PUR or PVC, Lengths: 1.5m / 3.0m / 5.0m / 10.0m |
| 2273095 | M12 x 1.0 Angled socket Pigtail Unshielded | 8 positions PUR, Lengths: 1.5m / 3.0m / 5.0m / 10.0m |



| TE Part Number | Description | Available In |
|----------------|--|---|
| 2273097 | M12 x 1.0 Straight socket Pigtail Shielded | 3 positions PUR or PVC, Lengths: 1.5m / 3.0m / 5.0m / 10.0m |
| 2273099 | M12 x 1.0 Straight socket Pigtail Shielded | 4 positions PUR or PVC, Lengths: 1.5m / 3.0m / 5.0m / 10.0m |
| 2273101 | M12 x 1.0 Straight socket Pigtail Shielded | 5 positions PUR or PVC, Lengths: 1.5m / 3.0m / 5.0m / 10.0m |
| 2273103 | M12 x 1.0 Straight socket Pigtail Shielded | 8 positions PUR, Lengths: 1.5m / 3.0m / 5.0m / 10.0m |



| TE Part Number | Description | Available In |
|----------------|--|--|
| 2273104 | M12 x 1.0 Straight socket Pigtail Shielded LED | 4 positions PUR, 2 LED, Lengths: 1.5m / 3.0m / 5.0m / 10.0m |
| 2273105 | M12 x 1.0 Straight socket Pigtail Shielded LED | 4 positions PUR or PVC, 3 LED, Lengths: 1.5m / 3.0m / 5.0m / 10.0m |



M12 Series Male to Female Y-cables

| TE Part Number | Description | Available In |
|----------------|-------------------------------------|--|
| 2273107 | M12 Y conn Male to 2 x M12 Female A | 4 positions PUR or PVC, Lengths: 0.3 m / 0.6 m / 1.0 m / 1.5 m / 2.0 m |



M8 to M12 Cable Assemblies

M8 Male to M12 Female Series

| TE Part Number | Description | Available In |
|----------------|--|--|
| 2273108 | M8 Straight plug to M12 Straight socket Unshielded | 3 positions PUR or PVC, Lengths: 0.3 m / 0.6 m / 1.0 m / 1.5 m / 2.0 m |
| 2273109 | M8 Straight plug to M12 Straight socket Unshielded | 4 positions PUR or PVC, Lengths: 0.3 m / 0.6 m / 1.0 m / 1.5 m / 2.0 m |



M8 Female to M12 Male Series

| TE Part Number | Description | Available In |
|----------------|--|--|
| 2273110 | M8 Straight socket to M12 Straight plug Unshielded | 3 positions PUR or PVC, Lengths: 0.3 m / 0.6 m / 1.0 m / 1.5 m / 2.0 m |
| 2273111 | M8 Straight socket to M12 Straight plug Unshielded | 4 positions PUR or PVC, Lengths: 0.3 m / 0.6 m / 1.0 m / 1.5 m / 2.0 m |



M12 to M12 Cable Assemblies

M12 Male to M12 Female Series

| TE Part Number | Description | Available In |
|----------------|---|---|
| 2273112 | M12 Straight plug to M12 Straight socket Unshielded | 3 positions PUR or PVC, Lengths: 0.3m / 0.6m / 1.0m / 1.5m / 2.0m |
| 2273113 | M12 Straight plug to M12 Straight socket Unshielded | 4 positions PUR or PVC, Lengths: 0.3m / 0.6m / 1.0m / 1.5m / 2.0m |
| 2273114 | M12 Straight plug to M12 Straight socket Unshielded | 5 positions PUR or PVC, Lengths: 0.3m / 0.6m / 1.0m / 1.5m / 2.0m |
| 2273115 | M12 Straight plug to M12 Straight socket Unshielded | 8 positions PUR, Lengths: 0.3m / 0.6m / 1.0m / 1.5m / 2.0m |

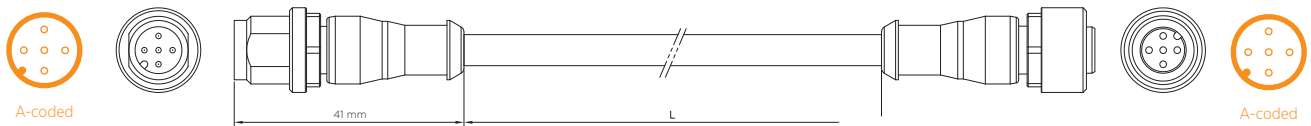

| TE Part Number | Description | Available In |
|----------------|---|---|
| 2273116 | M12 Straight plug to M12 Angled socket Unshielded | 3 positions PUR or PVC, Lengths: 0.3m / 0.6m / 1.0m / 1.5m / 2.0m |
| 2273117 | M12 Straight plug to M12 Angled socket Unshielded | 4 positions PUR or PVC, Lengths: 0.3m / 0.6m / 1.0m / 1.5m / 2.0m |
| 2273118 | M12 Straight plug to M12 Angled socket Unshielded | 5 positions PUR or PVC, Lengths: 0.3m / 0.6m / 1.0m / 1.5m / 2.0m |

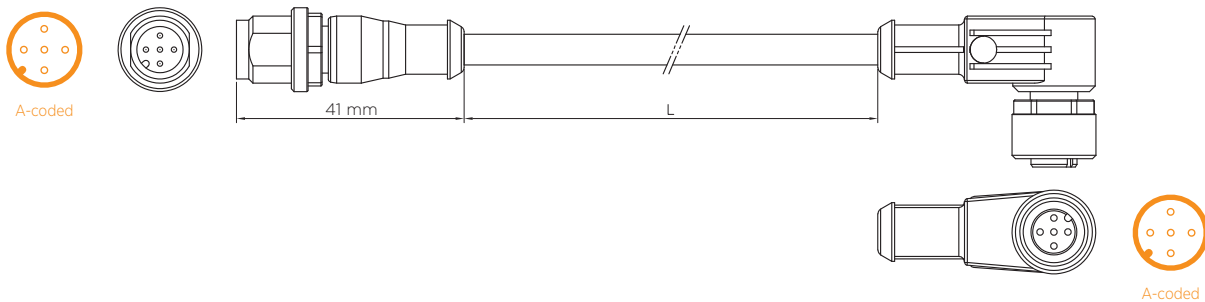

| TE Part Number | Description | Available In |
|----------------|---|---|
| 2273120 | M12 Angled plug to M12 Straight socket Unshielded | 3 positions PUR or PVC, Lengths: 0.3m / 0.6m / 1.0m / 1.5m / 2.0m |
| 2273121 | M12 Angled plug to M12 Straight socket Unshielded | 4 positions PUR or PVC, Lengths: 0.3m / 0.6m / 1.0m / 1.5m / 2.0m |
| 2273122 | M12 Angled plug to M12 Straight socket Unshielded | 5 positions PUR or PVC, Lengths: 0.3m / 0.6m / 1.0m / 1.5m / 2.0m |



M8 to M8 Cable Assemblies

M8 Female to M8 Male Series LED

| TE Part Number | Description | Available In |
|----------------|--|--|
| 2273124 | M8 Angled socket to M8 Straight plug 2 LED | 3 positions PUR, PVC, PUR/PVC and Welding Spark resistant Lengths: 0.3m / 0.6m / 1.0m / 1.5m / 2.0m |



M12 to M12 Cable Assemblies

M12 Female to M12 Male Series LED

| TE Part Number | Description | Available In |
|----------------|--|--|
| 2273125 | M12 Angled socket to M12 Straight plug 2 LED | 3 positions PUR, PVC, PUR/PVC and Welding Spark resistant Lengths: 0.3m / 0.6m / 1.0m / 1.5m / 2.0m |



| TE Part Number | Description | Available In |
|----------------|--|--|
| 2273126 | M12 Angled socket to M12 Straight plug 3 LED | 4 positions PUR, PVC, PUR/PVC and Welding Spark resistant Lengths: 0.3m / 0.6m / 1.0m / 1.5m / 2.0m |
| 2273127 | M12 Angled socket to M12 Straight plug 3 LED | 5 positions PUR or PVC, PUR/PVC and Welding Spark resistant Lengths: 0.3m / 0.6m / 1.0m / 1.5m / 2.0m |



I/O MODULES

Complementary to the M8/M12 cable assemblies and connectors, TE offers compact I/O modules for Industrial applications. The I/O modules are well accepted in the Industrial Automation industry and the concept of TE's I/O modules is simple, efficient and cost effective.

| | |
|--------------------------|---|
| Standard (IEC): | IEC 61076-2-104 for all M8 series and IEC 61076-2-101 for all M12 series |
| Ambient temperature: | -25°C to +85°C for the connectors (for cable assemblies please refer to specific drawings) |
| Connector Contacts: | Current rating per contact is 4 A |
| Shielding: Yes/No | Refer to drawing |
| Suitable Cable Diameter: | Refer to drawing |
| IP Rating: | IP65/67 |
| Sensor Type: | PNP |



M8 – With Cables

M8 Series



| Description | Positions | TE Part Number |
|----------------------|--------------|----------------|
| PUR cable 3.0 m | 3 pos 10 way | 2273129-1 |
| PUR cable 5.0 m | 3 pos 10 way | 2273129-2 |
| PUR cable 10.0 m | 3 pos 10 way | 2273129-3 |
| PUR cable 15.0 m | 3 pos 10 way | 2273129-4 |
| PUR/PVC cable 3.0 m | 3 pos 10 way | 2-2273129-1 |
| PUR/PVC cable 10.0 m | 3 pos 10 way | 2-2273129-2 |
| PUR cable 5.0 m | 3 pos 10 way | 2273130-1 |
| PUR cable 3.0 m | 4 pos 10 way | 2273132-1 |
| PUR cable 10.0 m | 4 pos 10 way | 2273132-2 |
| PUR/PVC cable 3.0 m | 4 pos 10 way | 1-2273132-1 |
| PUR/PVC cable 10.0 m | 4 pos 10 way | 1-2273132-2 |
| PUR cable 5.0 m | 3 pos 4 way | 2273133-1 |
| PUR cable 10.0 m | 3 pos 4 way | 2273133-2 |
| PUR/PVC cable 5.0 m | 3 pos 4 way | 1-2273133-1 |
| PUR/PVC cable 5.0 m | 3 pos 6 way | 2273137-1 |
| PUR cable 3.0 m | 3 pos 6 way | 2273138-1 |
| PUR cable 5.0 m | 3 pos 6 way | 2273138-2 |
| PUR/PVC cable 3.0 m | 3 pos 8 way | 2273142-1 |
| PUR/PVC cable 5.0 m | 3 pos 8 way | 2273142-2 |
| PUR/PVC cable 10.0 m | 3 pos 8 way | 2273142-3 |
| PUR cable 3.0 m | 3 pos 8 way | 1-2273142-1 |
| PUR cable 5.0 m | 3 pos 8 way | 1-2273142-2 |
| PUR cable 10.0 m | 3 pos 8 way | 1-2273142-3 |
| PUR cable 15.0 m | 3 pos 8 way | 1-2273142-4 |
| PUR cable 5.0 m | 3 pos 8 way | 2273144-1 |
| PUR cable 10.0 m | 3 pos 8 way | 2273144-2 |



All dimensions in mm.

M8 – With M12 Plug Connection

M8 Series

| Description | Positions | TE Part Number |
|-------------------------------|--------------|----------------|
| Dist. box M8 3 pos 10 way M12 | 12 pos. conn | 2273131-1 |
| Dist. box M8 3 pos 04 way M12 | 12 pos. conn | 2273134-1 |
| Dist. box M8 3 pos 04 way M12 | 8 pos. conn | 2273135-1 |
| Dist. box M8 3 pos 06 way M12 | 12 pos. conn | 2273139-1 |
| Dist. box M8 3 pos 06 way M12 | 8 pos. conn | 2273140-1 |
| Dist. box M8 3 pos 08 way M12 | 12 pos. conn | 2273146-1 |

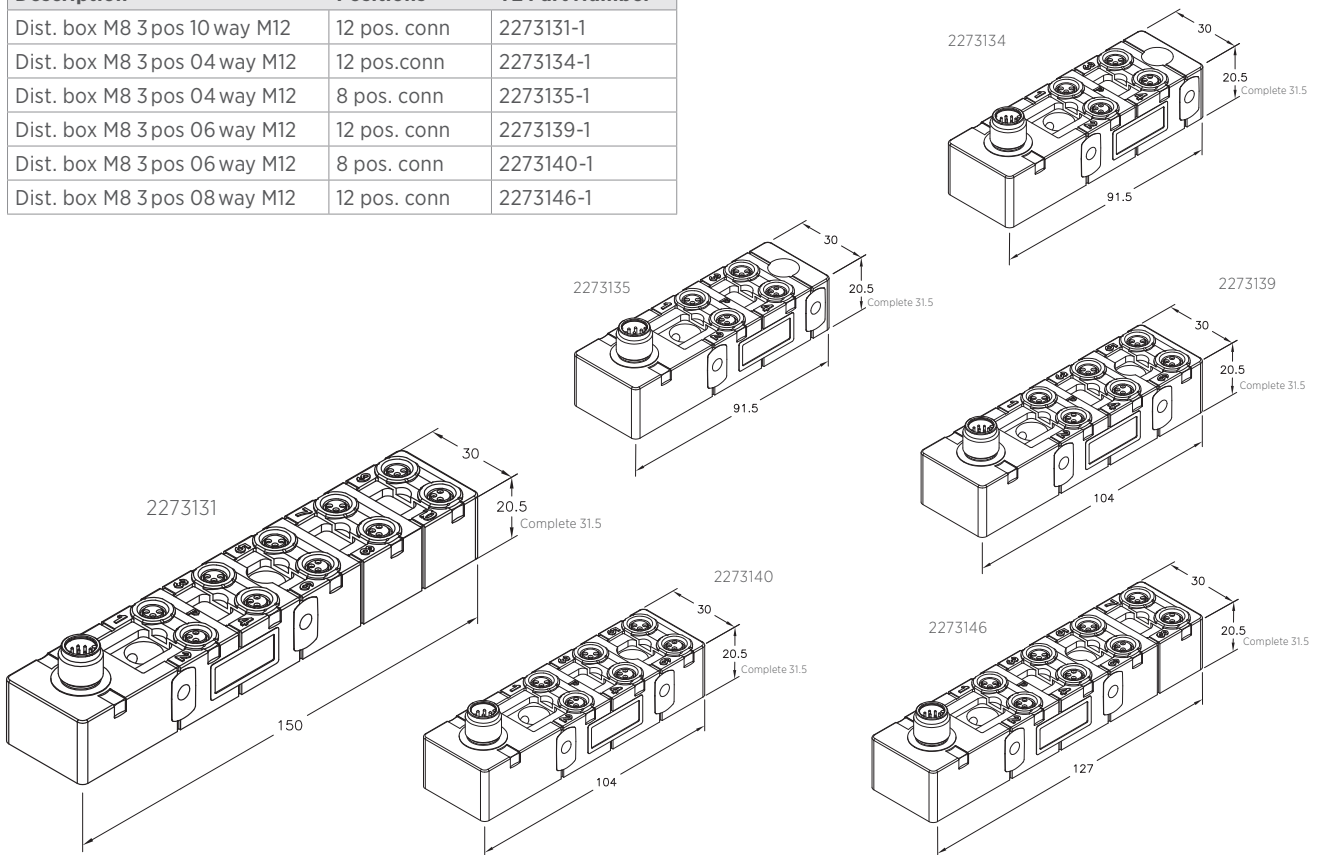

M8 – For Homerun Connection

M8 Series

| Description | Positions | TE Part Number |
|--------------------------------------|--------------|----------------|
| Distr box M8 3 pos 10 way PNP | 3 pos 10 way | 2273128-1 |
| Distr box M8 connection cap no cable | Nil | 2273136-1 |
| Inline or side mounting | 3 pos 8 way | 2273141-1 |
| PUR cable 3.0m | 4 pos 8 way | 2273147-1 |



All dimensions in mm.

M12 - With Cable

M12 Series

| Description | Positions | TE Part Number |
|----------------------------------|-------------|----------------|
| PUR/PVC cable 5.0 m | 4 pos 4 way | 2273150-1 |
| PUR/PVC cable 10.0 m | 4 pos 4 way | 2273150-2 |
| PUR/PVC cable 5.0 m | 5 pos 4 way | 2273153-1 |
| PUR/PVC cable 10.0 m | 5 pos 4 way | 2273153-2 |
| With PUR/PV Homerun Cable 10.0 m | 5 pos 4 way | 2273155-1 |
| PUR/PVC cable 3.0 m | 4 pos 8 way | 2273157-1 |
| PUR/PVC cable 5.0 m | 4 pos 8 way | 2273157-2 |
| PUR/PVC cable 10.0 m | 4 pos 8 way | 2273157-3 |
| PUR/PVC cable 15.0 m | 4 pos 8 way | 2273157-4 |
| PUR/PVC cable 3.0 m | 5 pos 8 way | 2273163-1 |
| PUR/PVC cable 5.0 m | 5 pos 8 way | 2273163-2 |
| PUR/PVC cable 10.0 m | 5 pos 8 way | 2273163-3 |
| PUR/PVC cable 15.0 m | 5 pos 8 way | 2273163-4 |
| PUR/PVC cable 20.0 m | 5 pos 8 way | 2273163-5 |
| PUR cable 3.0 m | 5 pos 8 way | 1-2273163-1 |
| PUR cable 5.0 m | 5 pos 8 way | 1-2273163-2 |
| PUR cable 10.0 m | 5 pos 8 way | 1-2273163-3 |
| PUR cable 15.0 m | 5 pos 8 way | 1-2273163-4 |
| PUR cable 20.0 m | 5 pos 8 way | 1-2273163-5 |
| PUR/PVC cable 5.0 m | 5 pos 8 way | 2273164-1 |



M12 - With M12/M23 Plug Connection

M12 Series

| Description | Positions | TE Part Number |
|---|---------------|----------------|
| Without homerun cable | 4 pos 8 way | 2273158-1 |
| Distr box M12 4-5 pos 8 way M12/12p PNP | 4-5 pos 8 way | 2273161-1 |
| Distr box M12 5 pos 4 way M23/19p PNP | 5 pos 4 way | 2273165-1 |



M12 - No Cable/With Cable Gland

M12 Series

| Description | Positions | TE Part Number |
|-----------------------|-------------|----------------|
| With plug cap | 4 pos 4 way | 2273151-1 |
| Without homerun cable | 5 pos 4 way | 2273152-1 |
| With plug cap | 5 pos 4 way | 2273154-1 |
| Without homerun cable | 4 pos 8 way | 2273156-1 |
| With plug cap | 4 pos 8 way | 2273159-1 |
| With plug cap | 4 pos 8 way | 2273160-1 |
| Without homerun cable | 5 pos 8 way | 2273162-1 |
| With plug cap | 5 pos 8 way | 2273166-1 |
| With plug cap | 5 pos 8 way | 2273167-1 |



All dimensions in mm.

M8/M12 Website

CONNECTORS
TE CONNECTIVITY (TE)
M8/M12 Connector System

[OVERVIEW](#) [RELATED MATERIALS](#)



EFFECTIVE TERMINATION

Safe and reliable communication. Our M8/M12 connector system provides a full solution that includes connectors, IO modules, and cable assemblies.

[LEARN MORE](#)

High-speed communication. Our M8/M12 connector system for machine industrial automation and control applications safely and reliably ensures the communication in industrial environments. Our connector solution includes an extensive connector range of PCB headers, cable assemblies and IO boxes, and provides users with a future-proof interface that supports higher bandwidth needs of up to 10 Gb/s.

M8/M12 Categories Partnumbers

- [M8 Connector System](#)
M8 connector part numbers
- [M12 Connector System](#)
M12 connector part numbers

te.com/m8m12

FIND THE PART NUMBERS AND INFORMATION YOU ARE LOOKING FOR

Additional Information

Read more about the connector and cable assembly portfolio on the M8/M12 website - in many different languages.

Download the product flyer

Find all information you need at one glance in the M8/M12 connector system product flyer.

View the video

See our M8/M12 connector system video and learn about the product features, benefits and applications.

Find the products

If you are looking for a specific product or part number, the M8/M12 website is the place to look. Find the images, drawings, technical specifications and much more.

te.com

TE, TE Connectivity, TE connectivity (logo) and Every Connection Counts are trademarks. All other logos, products and/or company names referred to herein might be trademarks of their respective owners.

While TE has made every reasonable effort to ensure the accuracy of the information in this brochure, TE does not guarantee that it is error-free, nor does TE make any other representation, warranty, or guarantee that the information is accurate, correct, reliable, or current. TE reserves the right to make any adjustments to the information contained herein at any time without notice. TE expressly disclaims all implied warranties regarding the information contained herein, including, but not limited to, any implied warranties of merchantability or fitness for a particular purpose. The dimensions in this catalog are for reference purposes only and are subject to change without notice. Specifications are subject to change without notice. Consult TE for the latest dimensions and design specifications.

© 2016 TE Connectivity Ltd. family of companies All Rights Reserved.

1-1773701-8 11/2016 Original: WR

CATALOG

TE Connectivity Automation & Control

Pfnorstr. 1
D-64293 Darmstadt
Germany

+49 6151 607 1999

www.te.com

Компания «Life Electronics» занимается поставками электронных компонентов импортного и отечественного производства от производителей и со складов крупных дистрибьюторов Европы, Америки и Азии.

С конца 2013 года компания активно расширяет линейку поставок компонентов по направлению коаксиальный кабель, кварцевые генераторы и конденсаторы (керамические, пленочные, электролитические), за счёт заключения дистрибьюторских договоров

Мы предлагаем:

- Конкурентоспособные цены и скидки постоянным клиентам.
- Специальные условия для постоянных клиентов.
- Подбор аналогов.
- Поставку компонентов в любых объемах, удовлетворяющих вашим потребностям.
- Приемлемые сроки поставки, возможна ускоренная поставка.
- Доставку товара в любую точку России и стран СНГ.
- Комплексную поставку.
- Работу по проектам и поставку образцов.
- Формирование склада под заказчика.
- Сертификаты соответствия на поставляемую продукцию (по желанию клиента).
- Тестирование поставляемой продукции.
- Поставку компонентов, требующих военную и космическую приемку.
- Входной контроль качества.
- Наличие сертификата ISO.

В составе нашей компании организован Конструкторский отдел, призванный помогать разработчикам, и инженерам.

Конструкторский отдел помогает осуществить:

- Регистрацию проекта у производителя компонентов.
- Техническую поддержку проекта.
- Защиту от снятия компонента с производства.
- Оценку стоимости проекта по компонентам.
- Изготовление тестовой платы монтаж и пусконаладочные работы.



Тел: +7 (812) 336 43 04 (многоканальный)

Email: org@lifeelectronics.ru