

MULTI-BEAM XL and MULTI-BEAM XLE Power Distribution Connector Systems

Board-Mount Connectors

Product Facts

- Single-piece molded housings
- Custom configurable modular design
- AC and DC power in the same connector — Meets UL safety requirements
- Current Interrupt ratings per UL 1977 — for “Hot-Plug” applications
- Compact size — suitable for distributed DC power applications
- Molded-in guide pins provide generous blind-mateability
- Up to 3 levels of contact sequencing:
 - 1st — Pwr/Gnd
 - 2nd — Pwr & Signals
 - 3rd — Trigger Signals
- Low Mating and Un-mating force
- Solder or press-fit termination to PCB
- Meets SSI power connector requirements for DPS, MPS and HPS applications
- 30 micro-inch [0.76 micro-meters] gold post-plated contacts for high reliability
- All MULTI-BEAM XL and MULTI-BEAM XLE products in this section are RoHS compliant



The MULTI-BEAM XL and MULTI-BEAM XLE modules are a blind-mateable board-to-board power distribution connector system. With a variety of available power contacts and a modular design, customers are able to customize this connector to their exact needs. In addition to selecting the number of power and signal contacts, customers are also able to choose the mating sequence of contacts they need for their specific application.

MULTI-BEAM XL connectors feature dual-beam and four-beam power contacts,

rated at 35A. The new MULTI-BEAM connector features a true hot-plug designed three-beam contact, rated at 43A.

The product is also available in versions complying with the Server Systems Infrastructure (SSI) Standard. MULTI-BEAM XL and MULTI-BEAM XLE products offer high reliability and high current density in a package designed specifically for modular hot-swappable power distribution systems. They are ideal for blind-mating in modular and rack mounted systems. The high perform-

ance design and heavy gold plated contacts meet requirements across many applications including power distribution for compact (1U) computer servers through high-end servers, fault-tolerant computers, networking equipment, telecommunication switches, medical instrumentation, and industrial control equipment.

The compact design also meets the I/O standard of modern modular and hot-swappable redundant (N+1) power supplies and uninterruptible power supplies.

Technical Documents

Product Specification
108-1973

Application Specification
114-13038



File # E28476

File # LR7189

For More Information

Check out product information at:
<http://mbxl.tycoelectronics.com>

Technical Support Center
1-800-522-6752

MULTI-BEAM XL and MULTI-BEAM XLE Power Distribution Connector Systems (Continued)

Board-to-Board Products

MULTI-BEAM XL Connector

- Expandable length to accommodate up to 36 power contacts
- Contact spacings are expandable to accommodate higher voltages and/or higher current requirements
- 4-beam or dual beam power contacts available
- Base metal made from high conductivity copper alloy (over 98% copper) offers superior performance compared to alternative materials

MULTI-BEAM XLE Connector

- Features new 3-beam power contact
- Two hot-pluggable power contacts to choose from:
 - 50A High power contact (35% increase compared to MULTI-BEAM XL connector)
 - 20A Low power contact (occupies 50% less PCB space than MULTI-BEAM XL power contact)
- Slimmer housing design allows 40% more current in the same space
- Over 40% lower mating force than original MULTI-BEAM XL connector
- Vented housing allows for better air flow

Evolution of MULTI-BEAM Power Contacts



Dual-Beam Contact

- Original design
- .017" thick stock



4-Beam Contact

- .017" thick stock
- 35A current rating
- Features eight independent beams
- Parallel current paths yield a lower contact resistance
- Tuned beam design provides lower mating forces and higher durability life cycles



3-Beam Contact

- Offered on new MULTI-BEAM XLE connector
- .020" Thick Stock
- 50A Current Rating
- Improved design offers lowest mating force available in MULTI-BEAM product line
- True hot-plug design preserves the separable contact interface to provide long term reliability after hot-mate and un-mate cycles

Power Contacts



Signal Contacts



Contact Wipe

Contact Type	Description	Sequence	Minimum Wipe
Power (or GND) Contact	Make First Break Last (MFBL)	1	0.200" [5.08 mm]
Power Contact	Standard	2	0.150" [3.81 mm]
Signal Contact	Standard	2	0.150" [3.81 mm]
Signal (trigger) Contact	Make Last Break First (MLBF)	3	0.100" [2.54 mm]

The MLBF power contact and the Standard Signal contact are sequenced to mate at the same time ... sequence #2.

Product Configurations and Part Numbers

The connector configuration is described by reading Left-to-Right on the Plug mating interface and Right-to-Left on the Receptacle mating interface. Custom configurations can be produced due to the modular design of the product.

Configuration Description: ACP indicates AC Power, P indicates DC Power, HDP indicates High Density Power, LP indicates Low Power (MULTI-BEAM XLE connector only), S indicates Signal. The corresponding contact spacing and voltage ratings are shown below.

ACP	P	HDP	LP	S
0.300" [7.62 mm] spacing	0.250" [6.35 mm] spacing	0.200" [5.08 mm] spacing	.115" [3.81 mm] spacing	0.100" [2.54 mm] grid
300 Volts*	200 Volts*	Connection to same voltage*	200 Volts*	60 Volts*

* With circuit board designed to UL 1950, IEC 60950

MULTI-BEAM XL Power Distribution Connector Systems

Board-Mount Connectors

Right-Angle Receptacles



Configuration *	Part Number	Application	Overall Length" and [mm]	PCB Tail Type (Solder, Press-Fit)	Power Contact Sequencing
1P/24S/1P	6450160-3	SSI "DPS"	1.925" [48.90 mm]	Solder	No
2P/24S/2P	1-6450160-0	Distributed DC Power + Signal	2.250" [57.15 mm]	Solder	No
3P/24S/3P	6450570-2	Distributed DC Power + Signal	2.750" [69.85 mm]	Press-fit	Yes
3ACP/24S/6P	6450170-8	AC and DC Power + Signal	3.650" [92.71 mm]	Solder	Yes
5P/24S/6P	6450160-5	SSI "MPS"	4.350" [110.49 mm]	Solder	No
7P/32S/7P	6450560-4	Distributed DC Power + Signal	4.350" [110.49 mm]	Press-fit	No
8P/28S	6450172-2	Distributed DC Power + Signal	3.350" [85.09 mm]	Solder	Yes
8P/32S/8P	6450160-1	AC and DC Power + Signal	5.450" [138.43 mm]	Solder	No
3ACP	6450173-1	AC Power	1.550" [39.37 mm]	Solder	Yes
8P	6450163-2	DC Power	2.650" [67.31 mm]	Solder	No
14P/32S	6450172-1	Distributed DC Power + Signal	4.950" [125.73 mm]	Solder	Yes
16S/4P	6450161-1	Distributed DC Power + Signal	2.050" [52.07 mm]	Solder	No
24S/6P	6450161-2	Distributed DC Power + Signal	2.750" [69.85 mm]	Solder	No
24S/8P	6450161-6	Distributed DC Power + Signal	3.250" [82.55 mm]	Solder	No

* Custom configurations are available — see page 29 for instructions to have Tyco Electronics build your custom part.

Vertical Receptacles



Configuration *	Part Number	Application	Overall Length" and [mm]	PCB Tail Type (Solder, Press-Fit)	Power Contact Sequencing
1P/24S/1P	6450540-1	SSI "DPS"	1.925" [48.90 mm]	Press-fit	No
2P/24S/2P	6450140-5	Distributed DC Power + Signal	2.250" [57.15 mm]	Solder	No
3P/24S/3P	1-6450140-0	Distributed DC Power + Signal	2.750" [69.85 mm]	Solder	No
4P/24S/4P	6450150-6	Distributed DC Power + Signal	3.350" [85.09 mm]	Solder	Yes
4P/24S/3ACP	6450150-3	AC and DC Power + Signal	3.150" [80.01 mm]	Solder	Yes
5P/24S/6P	6450540-2	SSI "DPS"	4.350" [110.49 mm]	Press-fit	No
6P/24S/6P	4-6450550-5	Distributed DC Power + Signal	4.250" [107.95 mm]	Press-fit	No
10P/24S/12P	3-6450550-2	Distributed DC Power + Signal	5.800" [147.32 mm]	Press-fit	Yes
3P	6450543-1	DC Power	1.400" [35.56 mm]	Press-fit	No
3ACP	6450543-6	AC Power	1.550" [39.37 mm]	Press-fit	No
4P	6450543-5	DC Power	1.650" [41.91 mm]	Press-fit	No
6P	6450553-2	DC Power	2.050" [52.07 mm]	Press-fit	Yes
7P	6450543-3	DC Power	2.400" [60.96 mm]	Press-fit	No
8P/28S	6450142-3	Distributed DC Power + Signal	3.350" [85.09 mm]	Solder	No
14P/32S	6450152-1	Distributed DC Power + Signal	4.950" [125.73 mm]	Solder	Yes
24S/6P	6450551-1	Distributed DC Power + Signal	2.750" [69.85 mm]	Press-fit	Yes
24S/3ACP	6450151-3	Distributed DC Power + Signal	2.200" [55.88 mm]	Solder	Yes
24S/8P	6450541-5	Distributed DC Power + Signal	3.250" [82.55 mm]	Press-fit	No

* Custom configurations are available — see page 29 for instructions to have Tyco Electronics build your custom part.

Note: All part numbers are RoHS compliant.

MULTI-BEAM XL Power Distribution Connector Systems (Continued)

Board-Mount Connectors
Right-Angle Plugs

Configuration *	Part Number	Application	Overall Length " and [mm]	PCB Tail Type (Solder, Press-Fit)	Signal Contact Sequencing
1P/24S/1P	6450330-1	SSI "DPS"	1.925" [48.90 mm]	Solder	Yes
2P/24S/2P	6450120-2	Distributed DC Power + Signal	2.250" [57.15 mm]	Solder	No
3P/24S/3P	6450130-6	Distributed DC Power + Signal	2.750" [69.85 mm]	Solder	Yes
4P/24S/3ACP	6450130-4	AC and DC Power + Signal	3.150" [80.01 mm]	Solder	Yes
3ACP/24S/6P	1-6450130-4	AC and DC Power + Signal	3.650" [92.71 mm]	Solder	Yes
5P/24S/6P	6450230-1	SSI "DPS"	4.350" [110.49 mm]	Solder	Yes
5P/32S/5P	2-6450120-4	Distributed DC Power + Signal	3.950" [100.33 mm]	Solder	No
6P/24S/6P	2-6450120-7	Distributed DC Power + Signal	4.250" [107.95 mm]	Solder	No
8P/32S/8P	6450120-1	Distributed DC Power + Signal	5.450" [138.43 mm]	Solder	No
10P/24S/12P	4-6450130-6	Distributed DC Power + Signal	5.800" [147.32 mm]	Solder	Yes
16S/4P	6450231-1	Distributed DC Power + Signal	2.050" [52.07 mm]	Solder	Yes
24S/6P	6450131-7	Distributed DC Power + Signal	2.750" [69.85 mm]	Solder	Yes
24S/3ACP	6450121-3	Distributed DC Power + Signal	2.200" [55.88 mm]	Solder	No
3ACP	6450123-3	AC Power	1.550" [39.37 mm]	Solder	N/A
3P	6450123-1	DC Power	1.400" [35.56 mm]	Solder	N/A
4P	6450123-2	DC Power	1.650" [41.91 mm]	Solder	N/A
6P	6450523-2	DC Power	2.050" [52.07 mm]	Press-fit	N/A
7P	6450123-5	DC Power	2.400" [60.96 mm]	Solder	N/A
8P/28S	6450132-3	Distributed DC Power + Signal	3.350" [85.09 mm]	Solder	Yes
14P/32S	6450132-4	Distributed DC Power + Signal	4.950" [125.73 mm]	Solder	Yes

* Custom configurations are available — see page 29 for instructions to have Tyco Electronics build your custom part.

Vertical Plugs

Configuration *	Part Number	Application	Overall Length " and [mm]	PCB Tail Type (Solder, Press-Fit)	Signal Contact Sequencing
1P/16S/1P	6600333-9	Distributed DC Power + Signal	1.650" [41.91 mm]	Press-fit	Yes
1P/24S/1P	6600330-4	SSI "DPS"	1.925" [48.90 mm]	Solder	Yes
2P/16S/2P	1-6600333-0	Distributed DC Power + Signal	2.150" [54.61 mm]	Press-fit	Yes
2P/24S/2P	1-6600333-2	Distributed DC Power + Signal	2.250" [57.15 mm]	Press-fit	Yes
3P/16S/3P	6600333-7	Distributed DC Power + Signal	2.650" [67.31 mm]	Press-fit	Yes
3ACP/24S/3ACP	1-6600333-1	AC Power + Signal	3.150" [80.01 mm]	Press-fit	No
4P/24S/4P	6600333-6	Distributed DC Power + Signal	3.350" [85.09 mm]	Press-fit	Yes
5ACP/24S/5ACP	6600333-1	Distributed DC Power + Signal	4.350" [110.49 mm]	Press-fit	Yes
7P/32S/7P	6600330-5	Distributed DC Power + Signal	4.350" [110.49 mm]	Solder	No
24S/8P	6600323-2	Distributed DC Power + Signal	3.250" [82.55 mm]	Press-fit	No
3ACP	6450503-3	AC Power	1.550" [39.37 mm]	Press-fit	N/A
8P	6600303-1	DC Power	2.650" [67.31 mm]	Press-fit	N/A

* Custom configurations are available — see page 29 for instructions to have Tyco Electronics build your custom part.

Note: All part numbers are RoHS compliant.

MULTI-BEAM XL Power Distribution Connector Systems (Continued)

Board-Mount Connectors

Specifications

Materials

Housing — High temperature thermo-plastic, UL 94V-0

Power Contacts — High conductivity Copper alloy

Signal Contacts — Copper alloy

Boardlocks — Phosphor bronze

Finish

Power and Signal Contacts — 30 microinches [.76 micrometers] min. gold over 50 microinches [1.27 micrometers] min. nickel on mating surfaces, 100 microinches [2.54 micrometers] min. tin over 50 microinches [1.27 micrometers] min. nickel at PCB terminations

Note: Tin-lead plating also available on press-fit connectors

Performance Specifications

Up to 55 Amps per power contact, de-rated to 35 Amps in equally energized (8 adjacent positions) connector.

Up to 4 Amps per signal contact, de-rated to 1.5 Amps in equally energized 24-position pin field.

Maximum Continuous Operating Temperature — 105°C.

Contact Resistance — 0.7 milli-ohm

Durability — 250 cycle

Radial Mis-alignment Capability — ± 0.075" [1.91 mm]

Minimum of 0.100" [2.45 mm] of contact wipe on shortest signal contact



Performance @ 30 Amps per Contact



See Cable Connectors on Pages 19-28



“NEW” MULTI-BEAM XLE Connectors

NEW

Product Facts

- **Two NEW hot-pluggable power contacts to choose from:**
 - 50 Amp high power contact
 - 20 Amp low power contact
- **Over 35% lower mating force than original MULTI-BEAM XL connectors**
- **Over 40% more current in the same over all PCB space**
- **Low-wear contact design passes Telcordia environmental exposure requirements**
- **New design allows more angular mis-alignment**



Tyco Electronics' new MULTI-BEAM XLE connectors are the latest addition to the MULTI-BEAM XL power connector product family. MULTI-BEAM XLE connectors feature a new 3-beam contact, made from a thicker/higher conductivity material than the original single beam or 4-beam designs.

The new 3-beam design allows for a greater angular mis-alignment between mating connectors and offers a lower mating force. In addition, MULTIBEAM XLE connectors offer a slimmer

housing design that reduces the overall PCB footprint and has the option of using a low power contact — the industry proven Universal Power Module (UPM) contact.

The new contacts and housing design allows more power in the same footprint — over 35% more current in the same space. MULTI-BEAM XLE connectors are as modular as the original MULTI-BEAM XL connectors in that they can be designed to fit specific customer needs.

Applications

- **Modular Hot-Swappable Power Supplies**
- **1U / 2U Servers**
- **High-end Computer & Telecommunications**

Equipment

- **Power Distribution Circuit Boards**
- **Power Distribution Cable Assemblies**

“NEW” MULTI-BEAM XLE Connectors (Continued)

Specifications

Materials

Housing — High temperature thermo-plastic, UL 94V-0

Power Contacts — High conductivity Copper alloy

Signal Contacts — Copper alloy

Boardlocks — Phosphor bronze

Finish

Power and Signal Contacts — 30 microinches [1.27 micrometers] min. gold over 50 microinches [1.27 micrometers] min. nickel on mating surfaces, 100 microinches [2.54 micrometers] min. tin over 50 microinches [1.27 micrometers] min. nickel at PCB terminations

Part Number 6450830-2
Right-Angle Plug

Part Number 6450880-1
Right-Angle Receptacle



MULTI-BEAM XLE Connector Part Numbers

Available Configurations	Part Numbers			Mating Part Numbers	
	Right-Angle Plugs	Vertical Plugs	Overall Length of Plug	Right-Angle Receptacle	Vertical Receptacle
1P/24S/1P	6450840-7	6450820-2	1.54" [39.12 mm]	6450870-5	6450850-3
2LP/8S/2LP	6450830-1	—	1.175" [29.84 mm]	—	6450860-1
6LP/24S/3P	6450830-2	—	2.555" [64.89 mm]	6450880-1	6450850-2
2P/32S/2LP	6450830-4	—	2.020" [51.30 mm]	6450870-1	—
2P/24S/2P	6450830-5	—	2.040" [51.81 mm]	6450870-3	—
3P/24S/3P	6450830-9	—	2.54" [64.52 mm]	6450870-4	—
3P/32S/3P	6450820-3	—	2.79" [70.87 mm]	6450870-8	—
32S/4LP	6450831-1	—	1.750" [44.45 mm]	6450871-1	—
6LP/24S/10P	1-6450830-0	—	3.86" [97.92 mm]	—	6450860-5
12P/48S/8LP	6450840-3	—	5.600" [142.24 mm]	6450880-4	6450860-3
4ACP/48S/12HDP	6450840-4	6450810-1	5.390" [136.90 mm]	6450880-3	6450860-2

Electrical

Current Carrying Capacity:

- 50 Amp high power contact (over 35% increase compared to MULTI-BEAM XL product)
- 20 Amp low power contact (occupies 50% PCB space than MULTI-BEAM XL power contact)

Contact resistance: 0.7 milliohm per contact at rated current

Configuration Description

ACP	P	HDP	LP	S
.300" [7.62 mm] spacing	.250" [6.35 mm] spacing	.200" [5.08 mm] spacing	.115" [2.92 mm] spacing	.100" [2.54 mm] spacing
300 Volts	200 Volts	50 Volts	200 Volts	50 Volts

ACP indicates the high power contact on 300 VAC spacing.
P indicates the high power contact on 200 VDC spacing.
LP indicates the low power contact on 200 VDC spacing.
S indicates the signal contact on 60 VDC spacing.

Application Tooling

Right-Angle Plugs:

Flat-rock seating tools (no unique tools required)

Right-Angle Receptacles:

Flat-rock seating tools (no unique tools required)

Vertical Plugs:

Contact Tyco Electronics for required seating tools

Vertical Receptacles:

Flat-rock seating tools (no unique tools required)

Note: All part numbers are RoHS compliant.

MULTI-BEAM XL Current Pass-Thru Power Distribution Connector System

Product Facts

- Combines PCB and cable mounted contacts
- Ideal for separating AC input from DC input
- Eliminates FASTON tab interface at the back of the connector housing
- Requires less space than two housing designs
- Terminates 12 AWG and 10 AWG wire
- Mates with Tyco Electronics vertical and right-angle PCB plugs
- High strength housing materials
- RoHS Compliant

Technical Documents

Product Specification

108-1973 and 108-2157

Application Specification

114-13038



The Cable Pass-Thru MULTI-BEAM XL receptacles securely terminate up to a 10 AWG wire directly into MULTI-BEAM XL PCB mounted receptacles. The design includes a “terminal position assurance” (TPA) feature that confirms the manually inserted wires are fully seated. The product offers a unique way of using the MULTI-BEAM XL PCB receptacles as a sort of “docking” connector. A single docking connector is far easier to mate to and to design around in a blind-mate application, than multiple power and signal connectors. By separating

some circuits to be cable terminated and some to be PCB terminated it allows both high voltage (AC) and low voltage (DC) power to pass through the same connector.

This separation of the AC and DC power eliminates the concerns of high voltage power running through circuit boards better suited to carry only low voltage circuitry. Additional applications may include designs where the power is better routed directly to a different PCB, through cables, yet passes through a single docking connector for ease in system design.

The Cable Pass-Thru connector is offered in both right-angle or vertical PCB-mount orientations and is supplied with either press-fit or solder pc tails. The connector is mate-able to either PCB mounted or cable mounted MULTI-BEAM XL or MULTI-BEAM XLE plugs. All MULTI-BEAM XL cable connectors are supplied pre-assembled by Tyco Electronics.

**MULTI-BEAM XL Current Pass-Thru
Power Distribution Connector System** (Continued)

Available Configurations	Part Numbers			
	Pass-Thru Right-Angle Receptacles	Mating Right-Angle Plugs	Pass-Thru Vertical Receptacles	Mating Vertical Plugs
3CP/1P/24S/2P	6450178-1	6450130-2	—	—
3CP/24S/2P	6450178-2	2-6450130-6	—	—
3CP/24S/3ACP	1888179-1	2-6450330-6	—	—
3CP/4P/24S	6450578-1	1-6450132-3	6450558-1	6600310-5
3ACP/24S/6P	—	1-6450130-4	6450558-2	—
3CP/8P/12S	1888132-1	—	—	—
3CP/20S/10P	6450578-2	6-6450130-2	—	—
3CP/16S	6450668-1	6450622-1	—	—

Note: Receptacles are the only MULTI-BEAM XL parts with Pass-Thru capability.

Configuration Description

CP	ACP	P	HDP	S
AC Power	AC Power	DC Power	High Density Power	Signal
Cable Power .300" spacing	PCB-Mount .300" spacing	PCB-Mount .250" spacing	PCB-Mount .200" spacing	PCB-Mount .100" grid



**MULTI-BEAM XL Coax Pass-Thru Connector —
Combine power, coax and signal all in one connector**

Right-Angle Plug	Cable Receptacle
292495-1	292491-1

The following coax contacts may be used with the coax pass-thru housings:

Pin Contact	Socket Contact
5221980-5	5221981-5

Note: All part numbers are RoHS compliant.

MULTI-BEAM XL Power Distribution Connector System Cable Receptacle Assemblies

Cable Receptacle Assemblies

Product Facts

- Single one-piece housing design
- Terminal Position Assurance (TPA) Secondary Locks on contacts help prevent contact back-out
- Pre-assembled made-to-order cable assemblies
- Installation to panel provides float in X, Y and Z directions
- Insulation crimp on all contacts
- 30 microinch (.76 micrometers) gold plated contacts for high reliability
- Touch-safe design passes UL1977 and IEC 60950 finger probe test
- AC and DC power in the same connector — meets UL & IEC safety requirements
- All MULTI-BEAM XL products in this section are RoHS compliant



MULTI-BEAM XL Cable Assemblies allow designers freedom to connect power supplies and power distribution subassemblies in a wide variety of applications. Expanding beyond board-to-board applications the cable assemblies are available for both cable-to-board or panel-mount applications and can terminate 8-16 AWG and 22-26 AWG wires all in one connector, without using adapter circuit boards. In addition, the power contacts are designed to be able to accept two-wire terminations which can further reduce harness complexity by reducing or eliminating mid-wire splices.

The use of high temperature glass filled housing materials, redundant contact retention and high conductivity contact materials allows the use of this connector in very high current density applications. The features work together to result in a highly durable and compact power connector, which offers industry leading minimum millivolt drop through the connection. The connector was designed to pass the UL 1977 and IEC 60950 finger probe test which makes the connector touch-safe. The insulation crimp adds further safety by keeping the insulation from being pulled away from the termination point. These features eliminate the

need for a secondary cable clamp which often can be size prohibitive.

The cable connectors are designed to mate to the de-facto standard Tyco Electronics MULTI-BEAM XL right-angle or vertical PCB plugs. The combination of PCB and cable connections, both with mixed power and signal arrangements provides a universal power distribution connector systems.

The cable assemblies are all RoHS compliant, designed to specific customer requirements and manufactured in Tyco Electronics' cable assembly manufacturing facilities.

Technical Documents

Product Specification
108-2157

Application Specification
114-13112

For More Information

Internet <http://tycoelectronics.com>

Check out product information at: <http://mbxl.tycoelectronics.com>

Technical Support Center 1-800-522-6752

MULTI-BEAM XL Power Distribution Connector System
Cable Receptacle Assemblies (Continued)

Configurations/Applications

Floating XYZ Panel-Mount Receptacle

- 0.060" [1.52] Nominal Float in X, Y and Z direction
- For modular installation of large power distribution systems
- Single connector replaces multiple power and signal connectors



Slide-to-Lock Receptacle

- 0.030" [0.76] nominal float in X and Y direction
- Ideal for modular installation of smaller systems requiring less space and less float — such as fan trays
- Replaces connectors which use multiple low power contacts to carry the total current
- Power only or Power Plus signal mixed



Cable-to-Board Receptacle

- Easy to mate/disconnect with squeeze-to-release latches
- Mates to right-angle or vertical MULTI-BEAM XL STR plugs
- Replaces two traditional connectors (1 signal and 1 power) with just 1 connector



MULTI-BEAM XL Power Distribution Connector System
Cable Receptacle Assemblies (Continued)

Panel-Mount Receptacles

Product Facts

- High strength glass-filled housing materials
- Expandable/modular housing design
- PMT Series floats +/- 0.060" [1.52] in X, Y and Z directions
- STL series floats 0.030" [0.76] in X and Y directions
- Mounting Hardware Kits:
Part Number 1600914-1 — Standard
Part Number 1600914-3 — High Force

Part numbers shown identify the main receptacle connector housing. Additional components (contacts, contact locks, etc.) are used to complete the cable assembly. See page 23 for contacts, secondary locks and application equipment information.



X, Y, Z Floating Receptacle



Slide-to-Lock Receptacle

Power and Signal Module Specifications

Power Module Widths:	Module Designation	Maximum Wire Size AWG [mm ²]	Max. Insulation Dia. inches [mm]
0.300 [7.62] (ACP)	300 (ACP)	8 [10.5]	0.272 [6.91]
0.250 [6.35] (P)	250 (P)	10 [6.6]	0.215 [5.46]
0.200 [5.08] (HDP)	200 (HDP)	12 [2.6]	0.156 [3.96]

Signal Module Width	Module Designation	Wire Range AWG [mm ²]	Insulation Range inches [mm]
0.200 [5.08] (8 Contacts)	Signals	22-26 [0.14-0.32]	0.036-0.054 [0.91-1.37]



Power Module



Signal Module

Configurations/Part Numbers

Available Configurations	Part Numbers			
	XYZ Series	STL Series	Mating PCB Plugs	
			Vertical	Right-Angle
3ACP	1600606-2	292499-1	6600303-7	6450123-3
4P	—	292499-4	6600303-2	6450123-2
4ACP	—	292499-3	6600303-3	—
5P	1600606-1	1761419-2	—	6450123-6
6P	—	292499-8	6600303-6	—
1P/16S/1P	1-1600636-3	1761819-4	6600333-9	—
1P/24S/1P	1600636-9	—	6600330-4	6450330-1
2P/16S/2P	1-1600636-0	—	1-6600333-0	—
2P/24S/2P	1600636-2	1761819-2	6600333-5	1-6450330-4
3P/16S/3P	1600636-8	—	6600333-7	—
3ACP/24S/3ACP	1-1600636-4	—	1-6600333-1	—
4P/24S/4P	1-1600636-5	—	6600333-6	—
4ACP/24S/12P	1600636-6	—	—	2-6450120-6
5ACP/24S/5ACP	1600636-1	—	6600333-1	5-6450130-0
7P/48S/7P	1-1600636-6	—	—	3-6450120-4

Note: All part numbers are RoHS compliant.

MULTI-BEAM XL Power Distribution Connector System Cable Receptacle Assemblies (Continued)

Cable-to-Board Squeeze-to-Release Receptacles

Product Facts

- High strength glass-filled housing
- Pre-installed squeeze-to-release latches
- Expandable/modular housing design
- Mates to Tyco Electronics vertical or right-angle PCB plugs



STR Series

Power and Signal Module Specifications

Power Module Widths:	Module Designation	Maximum Wire Size AWG [mm ²]	Max. Insulation Dia. inches [mm]
0.300 [7.62] (ACP)	300 (ACP)	8 [10.5]	.272 [6.91]
0.250 [6.35] (P)	250 (P)	10 [6.6]	.215 [5.46]
0.200 [5.08] (HDP)	200 (HDP)	12 [2.6]	.156 [3.96]
Signal Module Width	Module Designation	Wire Range AWG [mm ²]	Insulation Range inches [mm]
0.200 [5.08] (8 Contacts)	Signals	22-26 [0.14-0.32]	.036-.054 [0.91-1.37]

Technical Documents:

Product Specification
108-2157

Application Specification
114-13112

See page 23 for contacts, secondary locks and application equipment information.



Power Module



Signal Module

Configurations/Part Numbers

Available Configurations	STR Series	Part Numbers	
		Vertical	Right-Angle
2ACP	1600798-2	6600393-1	6450129-1
3P	1600798-3	6600393-2	6450129-2
3ACP	1600798-5	—	—
4P	1600798-4	6600390-1	6450129-3
6P	1600798-1	6600393-3	6450129-5
1P/24S/1P	1600788-8	6600380-2	6450128-1
2P/8S/2P	1-1600788-3	—	6450128-6
2P/16S/2P	1-1600788-0	6600383-5	—
2P/24S/2P	1600788-1	6600383-3	6450128-2
3ACP/24S/3ACP	1-1600788-2	6600383-6	—
4P/24S/4P	1-1600788-4	6600383-7	6450128-5
4ACP/24S/4ACP	1-1600788-5	6600383-9	—
6P/24S/6P	1-1600788-7	—	6450128-8
6P/32S/6P	1600788-7	6600383-1	—

Note: All part numbers are RoHS compliant.

MULTI-BEAM XL Power Distribution Connector System
Cable Receptacle Assemblies (Continued)

Cable Receptacle Components

Material and Finish

Body — 50 micro inches nickel over high conductivity copper alloy

Mating Area — 30 micro inches gold

Technical Documents

Product Specification

108-2157-1

Application Specification

114-13164



Power Contact

Power Contacts

Wire Size Range AWG	Insulation Diameter	Housing Width	Part Number	Applicator Tool	Hand Tool
12	.156 Max. [3.96]	.200 or .250 [5.08 or 6.35]	1-1600961-7 (make-first-break-last)	1385635-3	2063500-1
	.156-.176 [3.96-4.47]	.250 [6.35]		1385636-3	
14	.120-.156 [3.05-3.96]	.200 or .250 [5.08 or 6.35]	1-1600961-8 (Standard)	1385635-3	
	.090 Max. [2.29]	.250 [6.35]		1385636-3	
Wire Size Range AWG	Insulation Diameter	Housing Width	Part Number	Applicator Tool	Hand Tool
8	.215-.272 [5.46-6.91]	.300 [7.62]	1-1600960-7 (make-first-break-last)	1385637-3	N/A
10	.176-.215 [4.47-5.46]	.200 or .300 [6.35 or 7.62]		1385638-3	
2 @ 12	.130 Max. [3.30]	.300 [7.62]	1-1600960-8 (Standard)	1385637-3	
2 @ 14	.137 Max. [3.48]	.300 [7.62]		1385637-3	

Extraction Tool: Part Number 2063080-1

Note: Check the customer drawing for the applicable MULTI-BEAM XL housing to confirm the quantity of standard or make-first-break-last contacts needed. Standard and make-first-break-last contacts cannot be interchanged within the housing.



Power Contact Secondary Lock
Part Number 1600903-1

Secondary Power Locks:
Part Number 1600903-1

Note: One secondary lock needed for each power contact.



SDA SA Hand Tool
Part Number 2063500-1

Note: All part numbers are RoHS compliant.

MULTI-BEAM XL Power Distribution Connector System
Cable Receptacle Assemblies (Continued)

Cable Receptacle Components (Continued)

Material and Finish

Contact — Phosphor bronze plated gold over nickel in mating area



Signal Contacts

Wire Size Range AWG	Insulation Diameter	Version	Part Number	Extraction Tool	Hand Tool	Applicator
22-26	.036-.054 [0.91-1.37]	Low Pressure	5531216-5 (reel)	91156-2	91531-1	1426685-2
	.036-.054 [0.91-1.37]	High Pressure	5531224-6 (reel)			

Secondary Locks

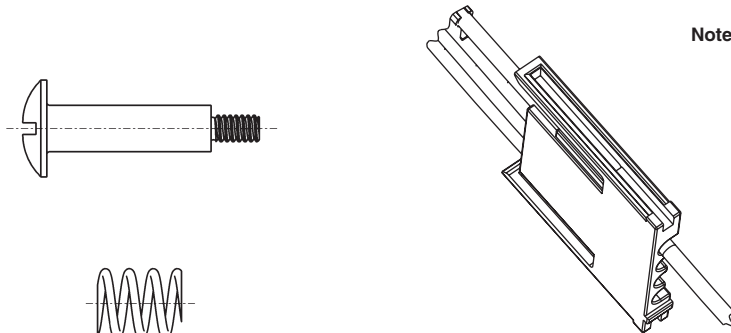

Note: One secondary lock needed for each column of signal contacts

Secondary Signal Locks:
Part Number 1600902-1



Float-Mount Hardware Kit

Part Number 1600914-1

(Standard Force)

Part Number 1600914-3

(High Force)

1 Kit / Cable Assembly;

Kit includes 2 screws, 2 washers and 2 springs

Note: Kit not needed for STR or STL housings



CERTI-CRIMP Hand Tool
Part Number 91531-1

Note: All part numbers are RoHS compliant.

**MULTI-BEAM XL Power Distribution Connector System
Cable Receptacle Assemblies (Continued)**

Specifications

Product Specifications

Power Contacts —
50 Amps on single 8 AWG wire

Signal Contacts —
5 Amps on single 22 AWG wire
0.050" [1.27] minimum float in X,
Y and Z direction

Sequenced Mating —
3 Levels Pwr/Grnd, Pwr & Signal,
Signal 250 Cycle Durability

Installed Connector Illustration



XYZ Series

STL Series



STR Series

Additional temperature-rise data available, contact Tyco Electronics Product Engineering.

Current/temperature rise data shown — from End-Of-Life qualification test.

MULTI-BEAM XL Product T-Rise Data



For more information see the product website @ <http://mbxl.tycoelectronics.com>

MULTI-BEAM XL Power Distribution Connector System Cable Plug Assemblies

Cable Plug Assemblies

Product Facts

- High strength housing materials
- Hot-Pluggable
- Installation provides float in X, Y and Z directions
- Sequenced mating
- RoHS complaint
- Modular mold design provides configuration flexibility
- Integral cable clamp supports contacts and provides strain relief in minimum amount of space
- 30 microinch (0.76 micrometers) gold plated contacts for high reliability
- Sold only as part of a pre-assembled cable assembly



The newest addition to the MULTI-BEAM XL cable assemblies are the cable mounted plugs. Produced with modular molds, the connectors can be made in a wide variety of sizes. The PCB mounted MULTI-BEAM XL plugs are typically rigidly mounted to hot-swappable power supplies and the systems they connect with. The "float blind-mate drawer connector" design of the MULTI-BEAM XL cable connectors helps eliminate the concern of an inadequately aligned chassis. The connector can accept mating parts misaligned by as much as 3 mm (± 1.5 mm), and still mate without applying stress

to solder or complaint pin terminations. The MULTI-BEAM cable plugs can terminate 8-14 AWG and 22-26 AWG wires all in one connector, without using adapter circuit boards. The use of high temperature glass filled housing materials, redundant contact retention and high conductivity contact materials allows the use of this connector in very high density applications.

The cable assemblies are all RoHS compliant designed to specific customer requirements and manufactured in Tyco Electronics' internal cable assembly manufacturing facilities.

Technical Documents

Product Specification

108-2157-1

Application Specification

114-13164

For More Information

Internet

<http://tycoelectronics.com>

Check out product information at:

<http://mbxl.tycoelectronics.com>

Technical Support Center

1-800-522-6752

MULTI-BEAM XL Power Distribution Connector System
Cable Plug Assemblies (Continued)

**Configurations/
Part Numbers**



PMT

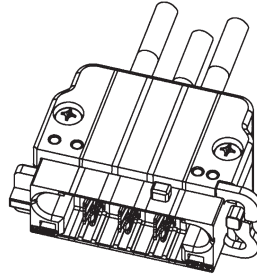

STL



STR

Board-to-Board Products

Power Module Widths:

0.300" (ACP)
0.250" (P)
0.200" (HDP)



Module Designation	Maximum Wire Size		Max. Insulation Dia.
	AWG	mm ²	
300 (ACP)	8	10.5	.272 6.91
250 (P)	10	6.6	.215 5.46
200 (HDP)	12	2.6	.156 3.96

Signal Module Width:

0.200" (8 Contacts)



Module Designation	Maximum Wire Size		Max. Insulation Dia.
	AWG	mm ²	
Signals	22-26	0.14-0.32	.036-.054 0.91-1.37

Configuration	PMT Series Plug	STL Series Plug	Mating Receptacles*		STR Series Plug	Mating Receptacles Vertical
			Vertical	Right-Angle		
3 ACP	—	1761421-1	6450543-6	6450173-1	—	—
4 P	—	1761421-3	6450543-5	—	1600814-2	—
1P/16S/1P	1600236-5	1600820-2	—	2-6450170-0	1600238-4	6450740-4
1P/24S/1P	1600236-4	1600820-1	6450540-1	6450160-3	1600238-3	6450740-5
2P/24S/2P	1600236-6	1600820-3	5-6450540-9	2-6450170-1	1600238-5	6450740-6
3ACP/24S/3ACP	1600236-7	1600820-4	4-6450550-1	2-6450170-2	1600238-6	6450740-7

PMT Series — Panel-Mount with total 3 mm float in X,Y and Z directions
 STL Series — Panel-Mount with total 1.5 mm float in X and Y directions
 STR Series — Squeeze-to-Release for removeable Cable-to-Board / I/O Applications
 *Specifications on mating PCB mountable receptacles:
 Product Specification 108-2157-1
 Application Specification 114-13164

Note: All part numbers are RoHS compliant.

**MULTI-BEAM XL Power Distribution Connector System
Cable Plug Assemblies (Continued)**

Board-to-Board Products

Connector Styles

Intermateable with Tyco Electronics MULTI-BEAM XL PCB mounted receptacles

Specifications

Wire Gauge — 8 AWG – 14 AWG

Sequenced Mating — 3 Levels: Pwr/Gnd, Pwr & Signal, Signal

Current Carrying Capacity — Power Contacts — 45 Amps* on single 8 AWG wire
Signal Contacts — 4 Amps on single 22 AWG wire

Durability — 250 Cycle

Temperature Range — 40°C – 105°C

Float — 1.5 mm float in X, Y, and Z Direction**

RoHS Compliant

UL, CSA, VDE Approvals Pending

*Based on End-of-Design Life Qualification Tests

**Mated to Tyco Electronics MULTI-BEAM XL receptacles only

PMT (Panel-Mount) for True X, Y, Z Floating

- Single-piece contact design — eliminates multiple contact interfaces
- Insulation crimp on all contacts
- Installation to panel provides float in X, Y and Z directions



STL (Slide-to-Lock) — Most Economical — Still Offering X and Y Floating

- Single-piece contact design — eliminates multiple contact interfaces
- Insulation crimp on all contacts
- Installation to panel provides float in X and Y directions



STR (Squeeze-to-Release) — To Connect Sub-assemblies

- Single-piece contact design — eliminates multiple contact interfaces
- Insulation crimp on all contacts
- Easy to mate/disconnect with squeeze-to-release latches



- Offered as pre-assembled, fully tested cable assemblies, as shown below
- Combines multiple power and signal connectors into a single Power I/O Connector

MULTI-BEAM XL Cable Plug T-Rise Data*



MULTI-BEAM XL and MULTI-BEAM XLE Connectors Custom Configuration Worksheet

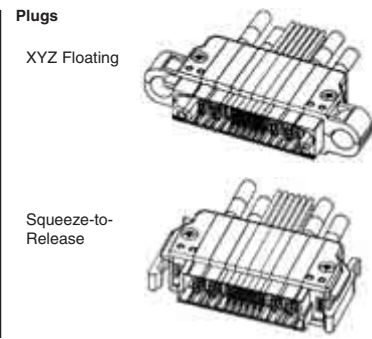
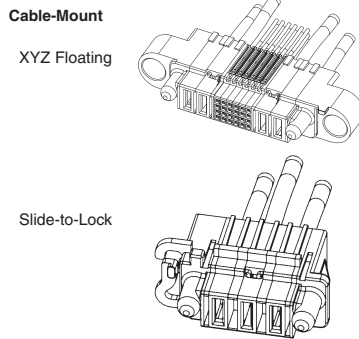
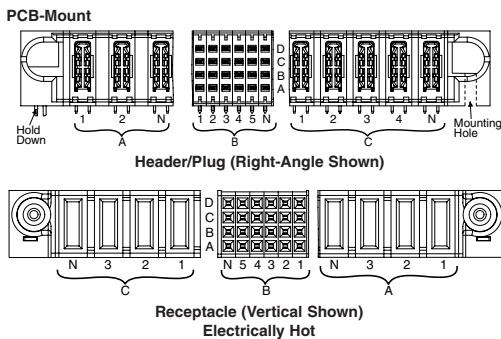

To create a unique configuration for MULTI-BEAM connectors simply complete this worksheet and forward it to your Tyco Electronics sales engineer.

1. Performance Grade	<input type="checkbox"/> MULTI-BEAM XL Connector	<input type="checkbox"/> MULTI-BEAM XLE Connector
2. Application	<input type="checkbox"/> Board-to-Board	<input type="checkbox"/> Cable-to-Board
3. Gender	<input type="checkbox"/> Plug (Male)	<input type="checkbox"/> Receptacle (Female)
4. Orientation	Cable Only → <input type="checkbox"/> Blind-Mate specify Floating or Slide-to-Lock Receptacle	<input type="checkbox"/> Latching
	PCB Only → <input type="checkbox"/> Right-Angle	<input type="checkbox"/> Vertical
5. Termination	(Cable Only) Power <input type="checkbox"/> 8 AWG <input type="checkbox"/> 10 AWG <input type="checkbox"/> 12 AWG <input type="checkbox"/> 14 AWG	
	Signal <input type="checkbox"/> 22 AWG <input type="checkbox"/> 24 AWG <input type="checkbox"/> 26 AWG	
6. Termination Style (PCB Only)	<input type="checkbox"/> Solder Tail .135" [3.43 mm]	<input type="checkbox"/> Press-Fit .120" [3.05 mm]
	<input type="checkbox"/> Solder Tail .165" [4.19 mm]	<input type="checkbox"/> Press-Fit .135" [3.43 mm]
		<input type="checkbox"/> Press-Fit .165" [4.19 mm]
7. Mounting to PCB	<input type="checkbox"/> Hold Downs (one on either end)	
	<input type="checkbox"/> .122" [3.10 mm] Mounting holes (Accepts #4 screws, right-angle connectors only)	
	<input type="checkbox"/> .150" [3.81 mm] Mounting holes (Accepts #6 screws, right-angle connectors only)	
8. Select # of Contacts	<input type="checkbox"/> Enter Power Contact Type (LP - Low Power, HP - High Power)	
Section A: (Power Contacts)	<input type="checkbox"/> Enter # of Power Contacts (Loaded with standard length Power Contacts)	
	<input type="checkbox"/> Enter the position(s) to be loaded with Pre-mate contact (Receptacles only) (Mate-First-Break-Last) (i.e. #1,#3, etc.)	
Contact Centerline Spacings:	<input type="checkbox"/> .200" [5.08 mm] (for High Power only)	
	<input type="checkbox"/> .250" [6.35 mm] (for High Power only)	
	<input type="checkbox"/> .300" [7.62 mm] (for High Power only)	
Section B: (Signal Contacts)	<input type="checkbox"/> Enter # of Signal Contacts (Multiples of 8 are standard, i.e. 16, 24, 32...)	
	<input type="checkbox"/> Enter the positions with Post-Mate Contacts (Mate-Last-Break-First, Plugs only) Note: Row A is standard (i.e. A1, A3, etc.)	
Section C: (Power Contacts)	<input type="checkbox"/> Enter Power Contact Type (LP - Low Power, HP - High Power)	
	<input type="checkbox"/> Enter # of Power Contacts (Loaded with standard length Power Contacts)	
	<input type="checkbox"/> Enter the positions to be loaded with Pre-Mate Contacts (Receptacles only) (Mate-First-Break-Last, i.e. #1, #3, etc.)	
Contact Centerline Spacings:	<input type="checkbox"/> .200" [5.08 mm] (HDP) <input type="checkbox"/> .250" [6.35 mm] (P) <input type="checkbox"/> .300" [7.62 mm] (ACP)	

9. Additional Requirements

10. Customer Information

Name: _____ **Company:** _____ **Location:** _____

Phone: _____ **Fax:** _____ **e-mail:** _____

(Submit to your local Tyco Electronics Sales Engineer)

MULTI-BEAM XL, MULTI-BEAM XLE, TE (logo) and TYCO ELECTRONICS are trademarks of the Tyco Electronics group of companies and its licensors.

MINIPAK High-Density Board-to-Board Power Connectors

Product Facts

- High current per linear inch
- Various configurations to meet requirements using less board space
- Built-in alignment feature
- Shrouded insulator design
- Meets safety regulatory requirements
- All MINIPAK products in this section are RoHS compliant

Typical Applications

- Telecom and computer applications
- Routers
- Servers, mini and supercomputers
- Removable battery packs
- Uninterruptible power systems (UPS)
- Hot-swap N+1 power distribution

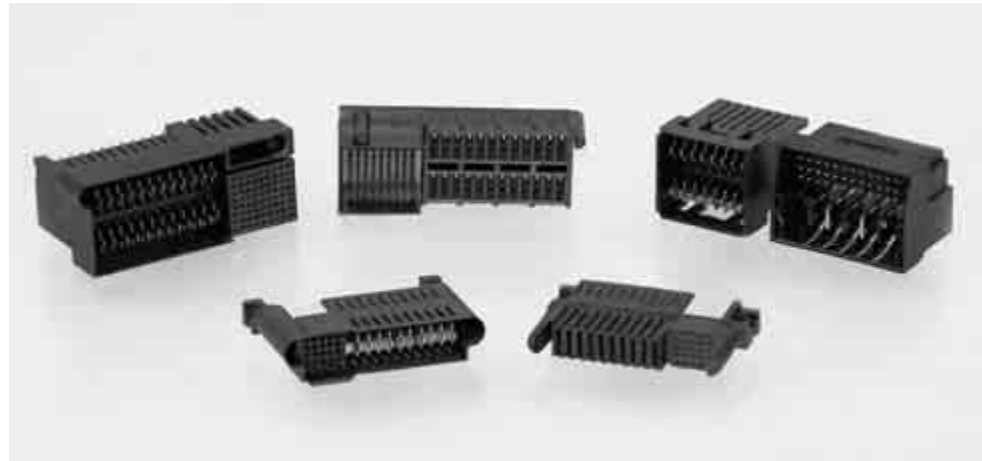

MINIPAK connectors are a family of board-to-board power connectors designed to deliver more current using less board real estate.

Product Varieties

This product family includes **MINIPAK high-density power connectors**, which are custom configurable and offer a combination of alignment guides, signal contacts, and DualBlade power contacts to meet different requirements. Following the PICMG μ TCA.0 Standard, the **MINIPAK HD**

connector is also available in this product line and is ideal for hot-plug telecommunications applications. With a two-row configuration, the **MINIPAK HDE** connector, designed to serve in both PCB-to-PCB and backplane power systems, occupies minimal PCB edge space. For applications needing a low profile solution, Tyco Electronics offers **MINIPAK HDL**, a blind-mateable board-to-board connector, which stands only 8 mm off the edge of the printed circuit board.

Wide Selection of Configurations

MINIPAK connectors are available in numerous configurations. Which MINIPAK connector is most suited to your application will depend on requirements such as AC input current and voltage, DC output currents and voltages, board-mount style, and available board space. Tyco Electronics will work with you to help determine the best solution to your application and can custom tool MINIPAK configurations if needed.

MINIPAK High-Density Board-to-Board Power Connectors (Continued)



MINIPAK High-Density Power Connectors

- 32 Amps per contact, fully loaded
- Features an innovative Dual Blade contact that allows splitting 4.5 mm pitch contacts into multiple voltage rails
- Various alignment guides, signal contacts, and power contacts available to use on 4.5 mm, 6.0 mm, and 7.5 mm pitches



MINIPAK HDL Connectors

- High density blind-mateable connector
- Low profile-stands just 8.0 mm off the PCB
- Solder and press-fit tails available
- Current rating of 16A
- Low contact resistance with mating forces less than 0.3lbs per contact



MINIPAK HD Connectors

- Designed to the PICMG MicroTCA.0 Standard
- Combines 24 power contacts and 72 high density signal contacts
- Rugged contact design helps provide long-term reliability
- Hot-plug design controls arc during hot mate/unmate cycles
- 3 mating levels



MINIPAK HDE Connectors

- Very high current density
- Two row configuration saves PCB space
- Two levels of contact sequencing available for mate-first-break-last operation
- Uses a hot-plug contact approved by UL for current interrupt applications

MINIPAK High-Density Board-to-Board Power Connectors (Continued)



Board-to-Board Products

Part Number	Right-Angle PCB Plug				Mating Pair Overall Length	Vertical PCB Receptacle		
	No. 30A Pwr	No. 15A Pwr	Signal Contacts	Tails		Mating Part Number	Tails	Special Feature
6651672-2	3	2	6	Solder	1.38 35.00	6651673-1	Compliant Press-Fit	DualBlade
6651670-1	3	2	24	Solder	2.87 73.00	6651671-1	Compliant Press-Fit	DualBlade
6651742-1	8	12	58	Solder	3.78 96.00	6651743-1	Compliant Press-Fit	Stacked
6651668-1	21	0	24	Solder	5.71 145.00	6651669-1	Compliant Press-Fit	—
6651380-1	6	5	36	Solder	4.50 114.50	6651381-2	Compliant Press-Fit	DualBlade

*The remaining power contacts are 30 Amps each

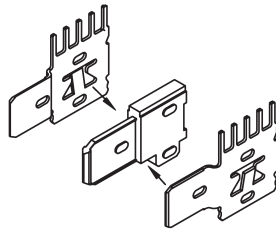

DualBlade Contact
DualBlade Contact provides two 15 Amp contacts in the space of one 30 Amp contact

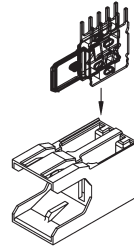

DualBlade Contact Housing Assembly

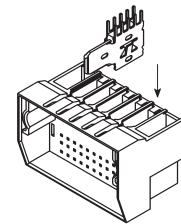

Stacked MINIPAK Connector

Co-Planar Stacked MINIPAK Connector

Part Number	Right-Angle PCB Plug				Mating Pair Overall Length	Right-Angle PCB Receptacle		
	No. 30A Pwr	No. 15A Pwr	Signal Contacts	Tails		Mating Part Number	Tails	Special Feature
1766056-1	2	6	36	Solder	1.55 39.30	1766057-1	Solder	Stacked

Custom MINIPAK Connector Configurations

If the standard MINIPAK connector configuration does not meet your application requirements, Tyco Electronics may be able to tool a custom MINIPAK connector solution depending on your requirements and production volume. Please consult Customer Service for details.

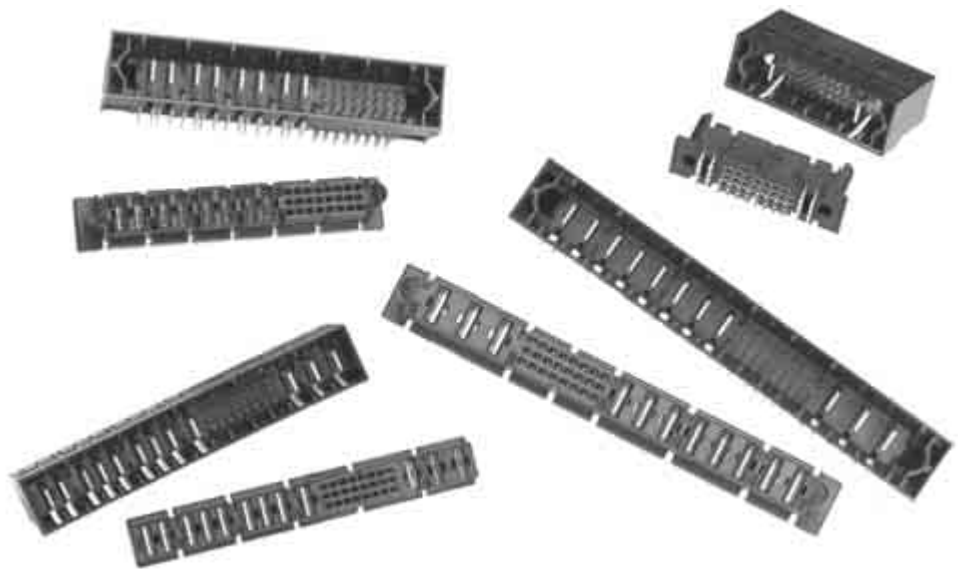

Note: All part numbers are RoHS compliant.

MINIPAK High-Density Board-to-Board Power Connectors (Continued)

Material	
Insulators	PPA, UL 94V-0 flammability rated, color black
Socket contacts	Phosphor bronze alloy
Signal pins	Brass alloy
Power blades	Copper alloy
Plating	
Contacts	Selective 30 microinches gold over nickel
Terminals	Tin over nickel
Environmental/Mechanical	
Connector operating temperature range	-40°C to +130°C
Mating forces	Power: 1.5lb/contact typical Signal: 0.2lb/contact typical
Electrical	
Contact current rating	Individual power contact: 65A max. ¹
Voltage ratings	AC Power: 125/250VAC, signal & DC power: up to 60V
Insulation resistance	5000Ω at 500V DC for 2 minutes, per MIL-STD 1344, Method 3003
Dielectric strength	Power 1,500VAC, signal 250VAC; for 1 minute, per MIL-STD 1344, Method 3001

¹ This is the UL rating for an individual power contact. Current rating for any given configuration with multiple contacts will depend on contact layout, quantity and spacing.

Contact Current Ratings

The graph to the right shows the current carrying capabilities of an individual power contact, and that of multiple contacts at 4.5, 6.0 and 7.5 mm contact spacing.

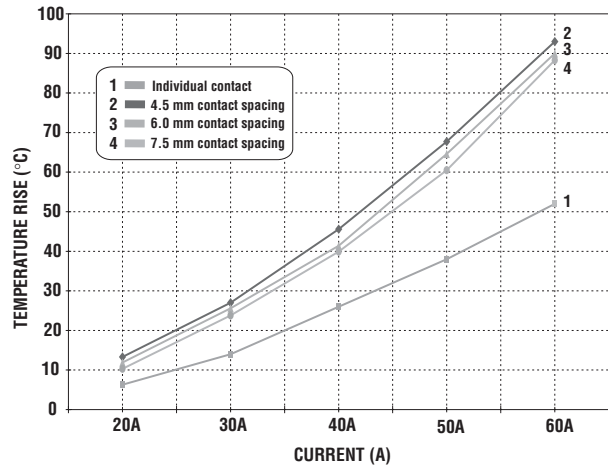

Safety Regulatory Agency Compliance

MINIPAK connectors have been evaluated and found to comply with the UL1977 standard and the CSA standard C22.2 No.182.3-M1987. Tyco Electronics will work with customers to obtain application-specific regulatory certifications if needed.



Connector Mounting

Termination Tails

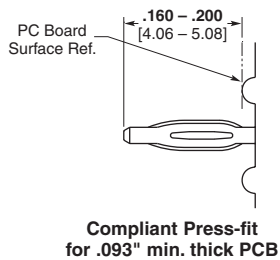

Dimension "A"	
Long Tail	Short Tail
.180 ± .020	.120 ± .020
4.57 ± 0.51	3.07 ± 0.51

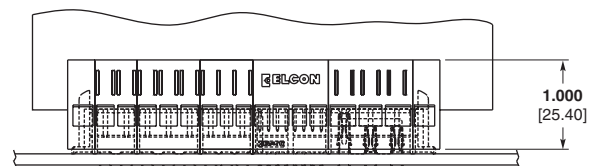

“NEW” MINIPAK HDL Connectors

NEW

Product Facts

- High-density, low profile, power/signal, blind-mate connector
- Developed to meet next generation 1U application by reducing airflow impedance
- Design is customizable
- Serves both solder reflow and press-fit applications with the same contact

Applications

- 1U Servers
- High End Servers
- Telecommunications Switches, requiring low profile
- Hot-pluggable power supplies

Technical Documents

Product Specification

108-2325

Application Specification

114-13215

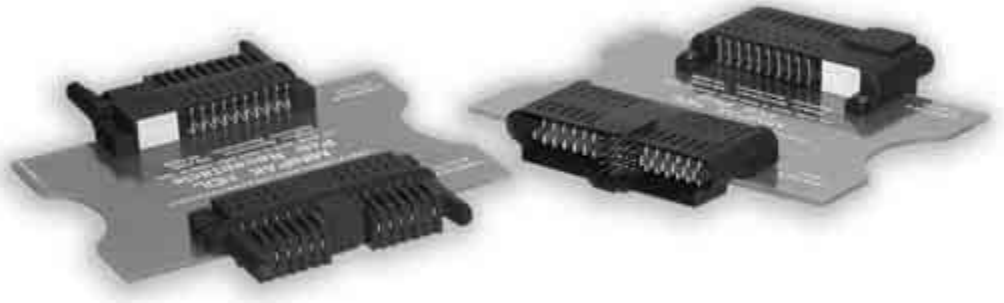

Tyco Electronics' new MINIPAK HDL connector combines a high-density power interface into a blind-mateable board-to-board connector, which stands only 8 mm off the edge of the printed circuit board.

The MINIPAK HDL product consists of a right-angle plug and right-angle receptacle, which utilizes an eye of the needle tail that can be used in both solder and press-fit applications. The contact offers a current rating of 16 amps, low contact resistance, and mating forces less than 0.3 pounds per contact.

The connector is designed and manufactured to be mass-customizable, allowing the customer to select a wide array of configurations and layouts. MINIPAK HDL connectors also contain three levels of mating sequences. This product is designed specifically for modular hot-swappable power distribution systems. The MINIPAK HDL connector offers 20% more current density in a smaller package than other products currently offered in the market.

Temperature Rise Chart



Simulated Side View of 1U Chassis



“NEW” MINIPAK HDL Connectors (Continued)

Contacts

Plating — Gold over nickel, or gold over palladium-nickel in mating area

Performance Data

Current Rating — 16 Amps

Max. Operating Temperature — 120°C



Right-Angle Receptacle
Part Number 2-1926733-5



Right-Angle Plug
Part Number 2-1926732-5

Configuration	Part Numbers	
	Right-Angle Plug	Right-Angle Receptacle
25S X 8P	1-1926732-8	1-1926733-8
25S X 10P	2-1926732-5	2-1926733-5
25S X 16P	4-1926732-6	4-1926733-6
40S X 24P	7-1926732-7	7-1926733-7
2P X 15S X 2P	1926720-2	1926721-2
6P X 15S X 6P	1-1926720-6	1-1926721-6
8P X 25S X 8P	2-1926720-5	2-1926721-5



Part Number 2-1926720-5



Part Number 2-1926721-5



Note: All part numbers are RoHS compliant.

MINIPAK HD Connectors

Product Facts

- Designed to the PICMG MicroTCA.0 Standard
- 30 microinches gold plating over nickel
- RoHS compliant
- 24 high current density power contacts, able to carry up to 14.5 Amps per contact when fully loaded
- Industry proven Universal Power Module (UPM) power contacts
- Hot-plug contact design controls arc during hot mate/unmate cycles
- 3 mating levels



Tyco Electronics supplies the Power Entry Module (PEM) connector specified in the PICMG MicroTCA Standard. The PICMG MicroTCA.0 Standard is one of the latest standards addressing future telecommunications needs. The MINIPAK HD connector combines 24 power contacts and 72 high density signal contacts. The power contacts are the industry

proven contacts utilized in the Universal Power Module (UPM) and are capable of carrying 14.5 Amps per contact when fully energized. Rugged contact design ensures long-term reliability and sacrificed contact tip, controls arcing during hot mate/unmate cycles. The MINIPAK HD also features 3 levels of mating and selective gold plating on contacts.

Contact Blades Product Facts

- Designed for Hot Swap applications
- Extended sacrificial contact tip absorbs arc
- Main contacts stay free of contaminants



MINIPAK HD Contact Blades

Technical Documents

Product Specification

108-2253

Application Specification

114-13182

Industry Standard

PICMG MicroTCA R1.0

MicroTCA and PICMG are trademarks of PICMG-PCI Industrial Computer Manufacturers Group, Inc.

MINIPAK HD Connectors (Continued)

**MicroTCA Connectors —
MINIPAK HD Board-to-
Board Connector**

**Vertical Receptacle,
Compliant Press-Fit**

**Part Number 1469920-1
(Tin-lead PCB Tails)**

**Part Number 1469920-2
(Tin Plated PCB Tails)**

The vertical connector consists of 72 2 mm pin and 24 Universal Power Module (UPM) receptacle contacts. The contacts have compliant pin tails for press-fit applications.



**PCB Seating Tool
Part Number 1901650-1**

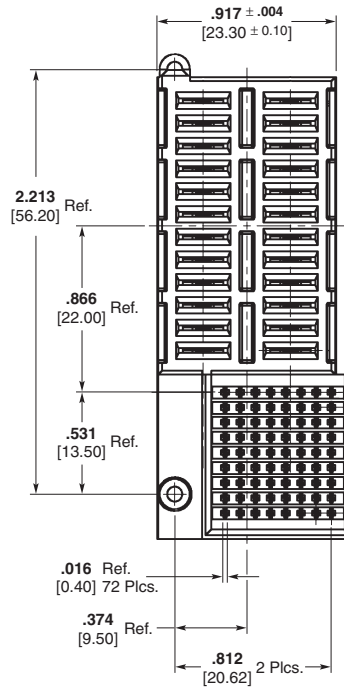

Part Number 1469920-1

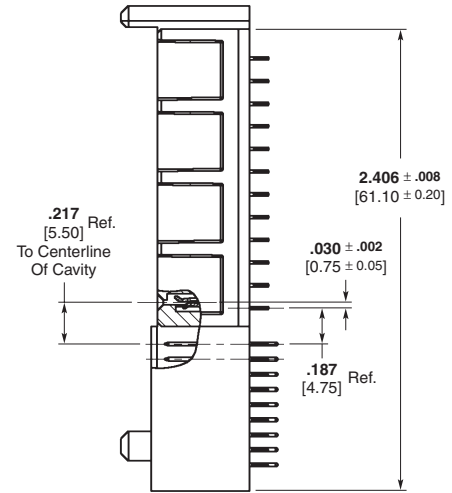

**Right-Angle Plug, Solder
Tail or Compliant Press-Fit**

**Part Number 1469921-1
(Solder Tail)**

**Part Number 1469922-1
(Press-Fit)**

**Part Number 1469922-2
(Press-Fit, Tin-Lead PCB
Tails)**

The right-angle connector consists of 72 high density signal pins and 24 right-angle UPM blades that feature 2 mating lengths for the mate first/break last ground sequencing. The right-angle connectors come in 2 piece tail variations, press-fit and solder.

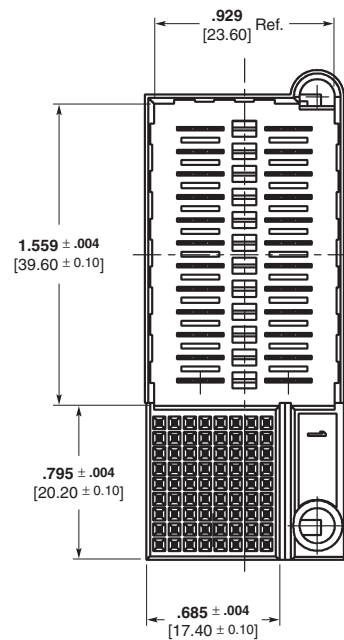

Part Number 1469921-1

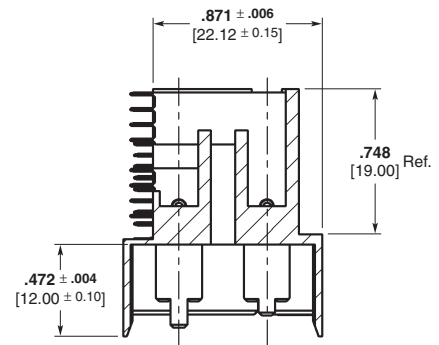

Note: All part numbers are RoHS compliant.

MINIPAK HDE Connectors

Product Facts

- Compatible with 2 mm equipment practices per IEC 61076-4-101
- One-piece molded housing — fewer parts to assemble to PCB
- Very high current density — 18 Amps per contact on each contact in an 8-position (2 x 4) connector
- 4 PCB tails distributes the current with just 4.5 amps per plated through hole
- Hot-pluggable contact design reduces contact degradation associated with live PCB insertions / extractions
- Two-levels of contact sequencing for mate-first-break-last operation



The new MINIPAK HDE connector is the latest high current power module designed to serve in both backplane power distribution and general PCB-to-PCB applications. It was designed to complement the most popular high-speed backplane connectors offered by Tyco Electronics, including HM-Zd, Z-PACK TinMan and MULTIGIG RT connectors.

The two-row configuration offers a benefit to the PCB designer. The power can be fed from either the top or bottom row, with the return path routed through the other remaining row. Alternatively, the same voltage rail can be routed to

both the top and bottom rows and the return path can be routed to both the top and bottom rows of adjacent contacts.

The two row configuration offers the additional benefit of occupying just half the linear PCB edge space of other types of board-to-board power modules.

The low mating force contact reduces the moment / stresses on the connector during mating and reduces the plating wear for long-term reliability.

The MINIPAK HDE connector has two-levels of blade lengths to provide mate-first-break-last operation for hot swap operation.

In addition, in the event the connector is used to mate or un-mate to a live load, the sacrificial contact tip absorbs the arc to keep the remaining contact mating surfaces free of damage. This “hot-plug” contact design has been approved by UL for current interrupt applications.

All MINIPAK HDE connectors are easily applied to the PCB with common “flat-rock” seating tools. The connector mates with Tyco Electronics’ Universal Power Module connectors found on page 55.

Technical Documents

Product Specification

108-2289

Instruction Sheet

408-10157

MINIPAK HDE Connectors (Continued)

Contacts

Industry proven Universal Power Module (UPM) style contacts

Performance Data

Current Rating — 18 Amps on each contact in the 8-position (2x4) connector

Low Level Contact Resistance — 2 milli-ohms max

Operating Temperature — -40°C to +105°C

Technical Documents

Product Specification
108-2289



Description	Part Number	Dimension L	Mating Connector*
2 x 3	1926223-1	.472" [12.00]	5-5223955-2
2 x 4	1926224-1	.590" [15.00]	120953-1
2 x 5	1926225-1	.708" [18.00]	120953-2
2 x 6	1926226-1	.826" [21.00]	120953-3
2 x 7	1926227-1	.944" [24.00]	120953-4
2 x 8	1926228-1	1.06" [27.00]	120953-5
2 x 9	1926229-1	1.18" [30.00]	120953-6
2 x 10	1926271-1	1.30" [33.00]	120953-7
2 x 11	1926272-1	1.42" [36.00]	120953-8
2 x 12	1926273-1	1.54" [39.00]	120953-9

*Mating connectors are single row, MINIPAK HDE requires 2 x mating connectors.

Note: For more information on the mating connector please see page 52. Receptacle Seating Tool Part Number 1585309-X.



Note: All part numbers are RoHS compliant.

FLATPAQ Modular Board-to-Board Power Connectors — Our Most Modular Board-to-Board Power Connector

Product Facts

- 32 Amp high-performance ELCON CROWN BAND power contacts
- True hot-plug power contacts available for current interruption under load
- Versatile modular design allows customized configuration to meet your specific application requirements
- Perpendicular, parallel and co-planar styles available
- Sequenced mating of power and signal contacts
- Solder and compliant press-fit termination to the board
- Unique active guide modules double as alignment guide and power contact
- All FLATPAQ products in this section are RoHS compliant

Typical Applications

- Board-to-board power interconnections
- Hot-swap N+1 power distribution for telecommunications, servers and mini-computers
- Uninterruptible power systems (UPS)
- Removable battery packs



FLATPAQ connectors provide hot-pluggable AC and DC power in board-to-board applications. Customized configurations of up to 45A power contacts, signal & logic lines, and guides (both active and passive) are enabled by the assembly of various standard modules. This allows the designer to specify guidance for blind-mating situations, contact mating sequence, spacing for voltage ratings, and current interruption under load (true hot-plug), to meet custom design requirements without incurring any tooling expense.

Product Highlights Highly Configurable

FLATPAQ connectors are custom configurable using standard modules that can be arranged in any order to meet the application requirements. It is even possible to have both power blades and power sockets in the same connector side. Using off-the-shelf, modular components enables quick turnaround of sample requests, typically within one week, to allow your design to move forward on schedule.

High-performance ELCON Power Contacts

FLATPAQ socket modules use proven CROWN BAND technology, for low insertion and extraction forces, minimal voltage drop and reduced temperature rise. The latest generation contacts are 45A USR rated (32.5A CNR) and can handle even higher currents when mounted on boards with 5 oz copper traces or on bus bars.

hot-pluggable socket contacts are rated at 35A USR, 20A CNR. Both hot-plug and regular sockets can be mixed in the same connector (as can both power blades and power sockets).

Standard power modules utilize the same contacts as the MINIPAK connectors for cost effectiveness. The original “float” mounted blade modules are still available where physically isolating the blade from the PCB solder joints is desired.

24-position straight mount Signal socket modules are now available in a cost effective 1A design.

Power and Signal Sequencing

Power contacts are available in Standard, Premate and Postmate lengths to meet your power sequencing requirements. Signal contacts have Standard and Premate length options, consult Customer Service for details.

FLATPAQ Modular Board-to-Board Power Connectors — Our Most Modular Board-to-Board Power Connector (Continued)

Various Contact Termination Styles

All connectors are available in two lengths of solder termination, .115" (2.9 mm) nominal for 0.062" (1.6 mm) thick boards, and 0.177" (4.5 mm) for 0.093" (2.4 mm) and 0.125" (3.18 mm) boards.

Straight mount socket connectors are also available with compliant 'Eye of the Needle' design press-fit terminals for 0.093" (2.4 mm) minimum thickness boards and bus

bars. Tyco Electronics will provide details of the recommended pressing fixture for each assembly.

All terminations fit 0.040 +/- .0030" (1.02 +/- .08 mm) diameter plated through holes.

Alignment Guides and Mounting Ears

FLATPAQ connector alignment guides improve gatherability in blind-mate situations and can be either electrically active (35A rated) or passive. Passive

guides should be used in conjunction with mounting ears when placed at the end of the connector. Mounting ears should also be considered on right-angle mounted connectors.

Finished Connector Drawing

Tyco Electronics will provide a customer drawing showing all envelope dimensions and PCB mounting pattern based on the configuration indicated using the layout sheet available at www.tycoelectronics.com.

See page 44 for details on completing the layout sheet. A drawing with general contact sequencing and alignment information is available; please contact Customer Service for a copy.

Safety Regulatory Agency Compliance

FLATPAQ connector has been evaluated by safety regulatory agencies for use in data, signal, control and power applications. Consult Customer Service for details.

Electrical Performance

The graphs below show the performance of the FLATPAQ contact design in terms of temperature rise against current. Tests were performed on 250 V power modules mounted on PC boards with 2 oz, 3 oz, and 5 oz copper traces.

Temperature Rise



Voltage Drop



FLATPAQ Connector Product Specifications



Materials		
Insulators	PPA, UL 94V-0 flammability rated, color black	
Power Blades	Copper alloy	
Power Sockets	Phosphor Bronze	
Hot-Plug Power Sockets & Active Guide Sockets	Crown Bands: Beryllium Copper Holder: Phosphor Bronze	
Signal Pin Contacts	Solder termination: Brass	
	Press-fit: Phosphor Bronze	
Signal Socket Contacts	1 Amp: Phosphor Bronze	
	3 Amp: Beryllium Copper	
Passive Guide Pin	Brass	
Active Guide Pin	Copper alloy	
Finishes		
Contacts	Selectively plated gold (30 microinches minimum) with tin on terminations, all over nickel	
Passive Guide Pin	Nickel	
Active Guide Pin	Silver	
Electrical		
Current Rating	UL	45 Amp
Power Contacts	CUR/CSA	32.5 Amp
Current Rating, Hot-Plug Power Contacts	UL	35 Amp at 250V, 50 cycles
Hot-Plug Power Contacts	CUR/CSA	20 Amp at 250V, 50 cycles
Signal Contacts, 1 Amp	UL	1 Amp, 250 VAC
	CUR/CSA	1 Amp, 250 VAC
Signal Contacts, 3 Amp	UL	3 Amp, 250 VAC
	CUR/CSA	2.5 Amp, 250 VAC
Contact resistance	Power	2 mΩ maximum initial, (3 mΩ maximum after 500 cycles durability), at 35A per MIL-STD-1344, Method 3004
	Signal	15 mΩ maximum initial, (30 mΩ maximum after 500 cycles durability), at 100mA, 20 mV, per MIL-STD-1344, Method 3002
Insulation Resistance	5,000 MΩ minimum at 500VDC for 2 minutes, per MIL-STD-1344, Method 3003	
Dielectric Strength	1,500 VDC for 1 minute, per MIL-STD-1344, Method 3001	
Mechanical		
Insertion Force	Power	4.0 lbf (17.8 N) maximum
	Signal	5.0 ozf (1.4 N) maximum, using .0305" (.775 mm) diameter steel test pin
Extraction Force	Power	1.0 lbf (4.4 N) minimum
	Signal	0.5 ozf (0.1 N) minimum, using .0295" (.749 mm) diameter steel test pin
Contact Retention (in insulator)	Power	10.0 lbf (44.4 N) minimum
	Signal	5.0 lbf (22.2 N) minimum
Durability	500 Cycles, per MIL-STD-1344, Method 2016	
Operating Temperature	-40 to +105° C	
Recommended PCB Hole	Finished hole: 0.040 +/- .0030" dia. (1.02 +/- .08 mm dia.) Drilled hole: 0.0453 +/- .0005" dia. (1.15 +/- .013 mm dia.) Copper Plate: 0.0010" (.025 mm) min. per surface Tin Plate: 0.0003" (.008 mm) min. per surface	
Press-Fit Tooling	Press fixture is recommended for compliant press-fit assemblies. Consult Tyco Electronics for tool drawing	
Marking	Connectors are marked with manufacturer's logo, part number and lot code	

FLATPAQ Connectors

Part Number 6646465-1
FLATPAQ 250V Straight
Socket Connector
4 Power, 24 Signal Contacts



Part Number 6646597-1
FLATPAQ 250V
Straight Socket Connection
with Active Guide Pin
2 (250V) Power,
2 amps Signal Contacts

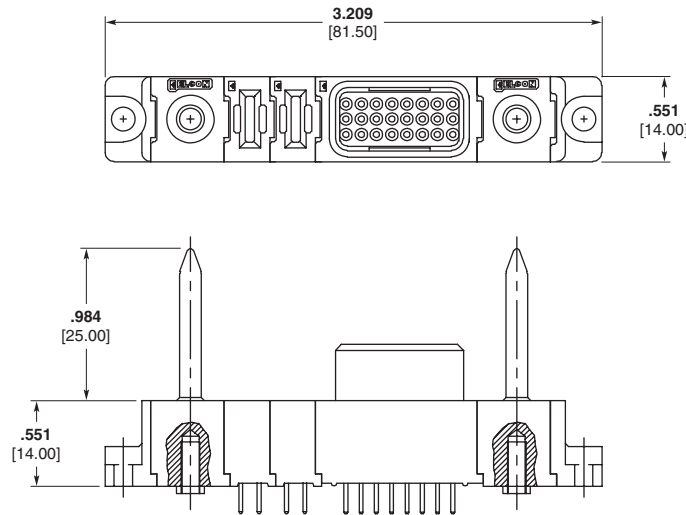

Part Number 6646722-1
FLATPAQ 600v
Right-Angle Pin Connector
with Guide Socket
7 (600V) Power,
6 Signal Contacts



Note: All part numbers are RoHS compliant.

How to Specify Your Modular FLATPAQ Connector

In order to build your Modular FLATPAQ connector, it is necessary to specify all application-specific requirements such as required modules, their order, termination, and sequencing. For this purpose, a Modular FLATPAQ Connector layout form such as the one shown below is available. Just complete the form and send it to Tyco Electronics Customer Service. We will generate a Customer Drawing for you to check and approve prior to connector production. Samples are also available upon request.

Board-to-Board Products

- 1 Enter your contact information, including signature and date.
- 2 Indicate the connector layout by filling in the FP number of each module required in the boxes, one per box. Use one form per mated pair. The left to right order of the modules should match the mating face views of the connector. When laying out right-angle assemblies, make sure that you look at the termination tails facing downwards.
- 3 For solder terminated assemblies, indicate the tail length for each half of the connector using the checkboxes to the right of the layout grid.

Sample Modular FLATPAQ Connector Layout Form

Instructions

1. Indicate the connector layout by filling in the FP number of each module required in the boxes, one per box. Use one form per mated pair.
2. The left to right order of the modules should match the **mating face views** of the connector. **When laying out right-angle assemblies,** make sure you look at the mating face with the termination tails facing downwards.
3. For **solder terminated assemblies,** indicate the tail length for each half of the connector using the checkboxes to the right of the layout grid.
4. Sign, date and send the completed form to your local Tyco Electronics Sales Engineer.

Upon receipt of this form, Tyco Electronics will generate a Customer Drawing for you to check and approve prior to connector production.

Write the "FP" numbers to indicate the layout of one half of the connector assembly, matching the left to right order with the mating face view of the connector (right-angle assembly tails facing downwards).

FP	FP	FP	FP	FP	FP	FP	FP	FP	FP	FP	FP	FP	FP	FP	ENTER CUSTOMER INFORMATION	
															Company	Location
															Contact Name	Title
															Telephone	Fax
															Email Address	
															I am: <input type="checkbox"/> End user <input type="checkbox"/> Contract manufacturer (end user: _____)	
															Signature	Today's Date
																Annual Quantity Required

Submit to your local Tyco Electronics Sales Engineer.

Write the "FP" numbers to indicate the layout of the mate of the above assembly, matching the left to right order with the mating face view of the connector (right-angle assembly tails facing downwards).

FP	FP	FP	FP	FP	FP	FP	FP	FP	FP	FP	FP	FP	FP	FP	Solder Tail Options	
															<input type="checkbox"/> .115" (2.9 mm); .062" thick boards	
															<input type="checkbox"/> .177" (4.5 mm); .093/.125" boards	

Right-Angle Mount

250 V Power Modules

FP151 Standard Blade
FP105 Float, Standard

FP152 Premate Blade
FP106 Float, Premate

FP153 Postmate Blade
FP107 Float, Postmate

FP104 Hot-Plug Socket

FP512 Spacer, 250 V

Signal Modules

FP302 24-Pin

FP303 24-Pin Socket

FP314 6-Pin

FP315 6-Pin Socket

600 V Power Modules

FP155 Standard Blade
FP121 Float, Standard

FP156 Premate Blade
FP122 Float, Premate

FP157 Postmate Blade
FP123 Float, Postmate

FP120 Hot-Plug Socket

FP514 Spacer, 600 V

Mounts

FP500 Left Flange Mount

FP501 Right Flange Mount

Guides

Right-Angle Guide Sockets
FP506 Passive
FP516 Active

Right-Angle Passive Guide Pin
FP507

Straight Mount

250 V Power Modules

FP150 Socket, Solder
FP250 Socket, Press-fit

FP100 Hot-Plug, Solder
FP200 Hot-Plug, Press-fit

FP161 Standard Blade
FP101 Float, Standard

FP162 Premate Blade
FP102 Float, Premate

FP163 Postmate Blade
FP103 Float, Postmate

FP511 Spacer, 250 V

Signal Modules

FP300 24-Pin, Press-fit
FP400 24-Pin Skt., Press-fit

FP318 24-Pin Skt.
FP418 24-Pin Skt., Press-fit

FP312 6-Pin
FP412 6-Pin, Press-fit

FP313 6-Pin Socket, 3A Rated
FP413 6-Pin, 3A, Press-fit

FP301 24-Pin Skt., 3A Rated
FP401 24-Pin Skt., 3A, Press-fit

600 V Power Modules

FP154 Socket, Solder
FP254 Socket, Press-fit

FP116 Hot-Plug, Solder
FP216 Hot-Plug, Press-fit

FP165 Standard Blade
FP117 Float, Standard

FP166 Premate Blade
FP118 Float, Premate

FP167 Postmate Blade
FP119 Float, Postmate

FP513 Spacer, 600 V

Mounts

FP500 Left Flange Mount

FP501 Right Flange Mount

Guides

FP502 Straight Passive Guide Socket

FP503 Passive Guide Socket

FP515 Active, M3 Guide Socket

Straight Guide Pins
FP515 Active, M3 Guide Socket

FP517 Active, 4-40 Guide Pin

Note: All modules are solder tail termination unless indicated as compliant Press-fit. Select solder tail length using checkboxes to the right of the connector layout grid above. 0.093" or thicker boards are recommended for compliant Press-fit termination style. Consult Tyco Electronics for signal module sequencing. See Catalog 1773096 for benefits of Hot-Plug and Float options.

How to Obtain Modular FLATPAQ Connector Layout Forms

Modular FLATPAQ Connector layout forms can be obtained directly from Customer Service or through your Tyco Electronics Sales Engineer. They can also be downloaded from the website; at <http://www.tycoelectronics.com>.

ICCON Single Pole Power Connectors

Product Facts

- Uses high-performance Crown contact
- 35A current rating
- True compliant press-fit and solder tails
- Pin locking feature option
- Standard DIP footprint .300 x .100 and ICCON SLIMLINE connector .100 x .100
- Insulator rated at 105°C, UL 94V-0
- Meets safety regulatory requirements
- #8 AWG wire size
- Parallel and perpendicular
- Sequencing capability
- All ICCON products in this section are RoHS compliant

Typical Applications

- Power distribution
- Board-to-board interconnection
- Board-to-busbar interconnection
- Board-to-wire interconnection
- High-density power designs
- Board stacking



ICCON connectors provide a reliable high current power interconnection with quick connect/disconnect function for space constrained motherboard-daughterboard, cable-board and board-busbar power delivery applications.



Product Highlights

High Performance Contact

ICCON connectors use ELCON CROWN BAND Contact, a multifingered spring which provides a greater surface contact area, thus ensuring small millivolt drop, minimum heat generation and very low insertion and extraction forces.

Optional Locking Feature

The optional locking feature provides minimum 5 lbs. (2.21kg) retention force to improve connection integrity, securing against accidental unmating in harsh mechanical conditions.

Support for Multiple Mounting Styles

ICCON connectors are available with press-fit or solder tails for mounting on both PC boards and bus bars. Tyco Electronics uses eye of the needle true compliant tails for the most reliable mounting using solderless techniques. Each ICCON connector has a 10 pin DIP footprint for convenient industry standard mounting. Through hole socket connectors can be used in "bottom entry" applications.

Mating with Discrete Contacts

For further versatility, ICCON connector products can mate with discrete contacts, available in a variety of termination types.

ICCON SLIMLINE Connectors

With a footprint close to 30% smaller than the standard ICCON connector products, the ICCON SLIMLINE connector products allow integrating more components in less board real estate, providing substantial space savings compared to connectors of this type in the same performance range.

Stacked ICCON

Designed for motherboard-to-daughtercard power distribution systems, the Stacked ICCON combined power/guide module occupies significantly less PCB edge space than separate modules. Providing more than 200 Amps/inch, this right-angle mounted connector is ideal for applications needing high current density.

ICCON Standard DIP Connectors (.300 x .100 footprint)

Right-Angle Receptacle

Part Number 6643232-1 Solder
Part Number 6643272-1 Compliant



Right-Angle Pin

For Part Numbers and "A" Dimension
See Table Below



Vertical Receptacle

Part Number 6643264-1 Through Hole, Solder
Part Number 6643219-1 Closed, Solder
Part Number 6643269-1 Through Hole, Compliant



Vertical Pin

For Part Numbers and "A" Dimension
See Table Below



Right-Angle Pins Solder Tail	Compliant	Locking Style	Length "A"
6643281-1	6643275-1	Non-Lock	.470 [11.93]
6643276-1	6643273-1	Lock	.470 [11.93]
6643431-1	6643442-1	Non-Lock	.570 [14.48]
6643432-1	6643443-1	Non-Lock	.750 [19.05]
6643433-1	6643444-1	Non-Lock	1.000 [25.40]
6643434-1	6643445-1	Non-Lock	1.250 [31.75]
6650785-1	6643446-1	Non-Lock	1.500 [38.10]
6643435-1	6643447-1	Non-Lock	1.750 [44.45]

Vertical Pins Solder Tail	Compliant	Locking Style	Length "A"
6643283-1	6643274-1	Non-Lock	.470 [11.93]
6643266-1	6643271-1	Lock	.470 [11.93]
6643436-1	6643449-1	Non-Lock	.570 [14.48]
6643437-1	6643450-1	Non-Lock	.750 [19.05]
6643438-1	6643451-1	Non-Lock	1.000 [25.40]
6643439-1	6766439-1	Non-Lock	1.250 [31.75]
6643440-1	6766440-1	Non-Lock	1.500 [38.10]
6643441-1	6766441-1	Non-Lock	1.750 [44.45]

Note: All part numbers are RoHS compliant.

ICCON Discrete Contacts

Crimp Socket

Part Number 6648317-1 #8 AWG



Crimp Pins

Part Number 1766163-1
#8 AWG Non-Lock
Part Number 1766160-1
#8 AWG Lock
Part Number 1766816-1
#10 AWG Non-Lock
Part Number 1766161-1
#10 AWG Lock

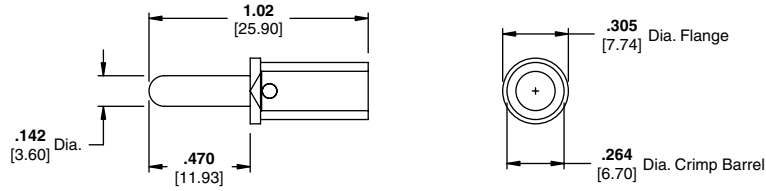

Board-Mount Pin — Floating

Part Number 6643252-1
"A" = 1.250 (31.75)
Part Number 6643253-1
"A" = 1.350 (34.29)

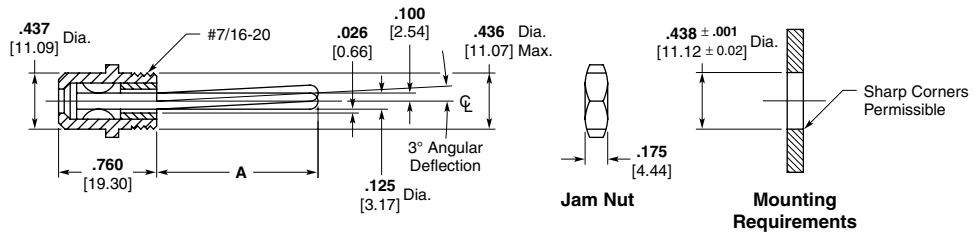

Mating PCB-Mount

Part Number 6643248-1

Mounted Example:

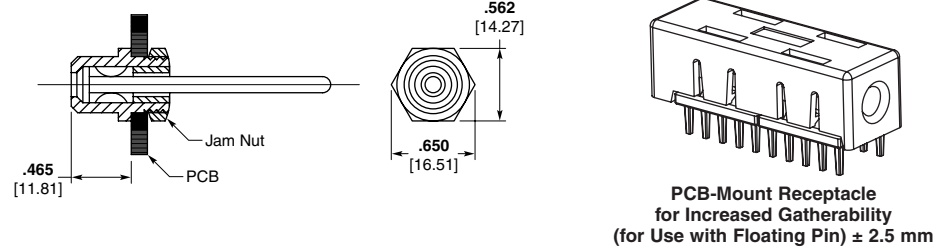

Board-Mount Pin

Part Number 1766815-1
"A" = 1.250 (31.75)
Part Number 1766157-1
"A" = 1.350 (34.29)



Double-Ended Board-Mount Pin

Part Number 1766817-1

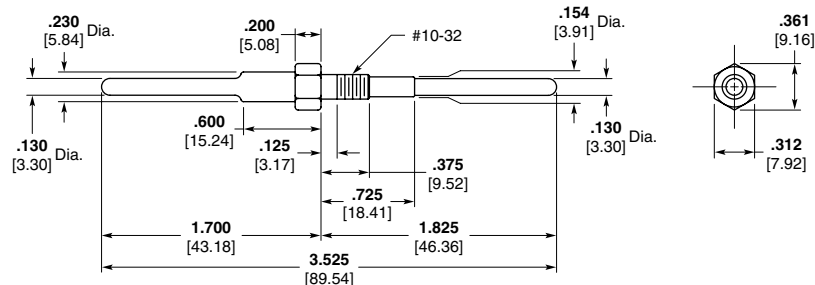

Note: All part numbers are RoHS compliant.

ICCON Connector Electrical Performance

Stacked ICCON

2-Position Right-Angle Socket Assembly

25 Amps per socket
Part Number 2085181-1

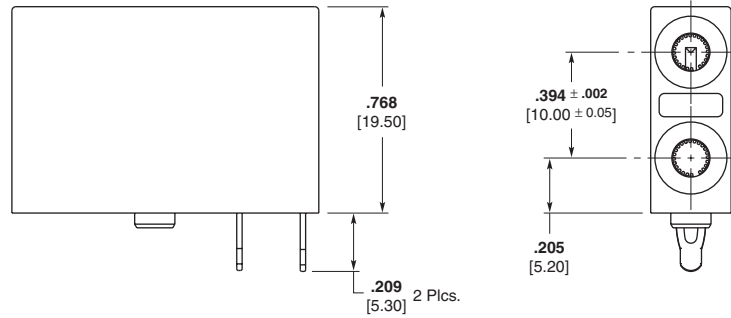
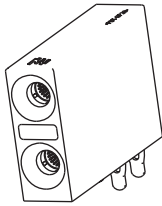

Stacked ICCON Pins



Dim. A	Part Number
.630 16.00	1766663-1
.709 18.00	1766663-2
.787 20.00	1766663-6

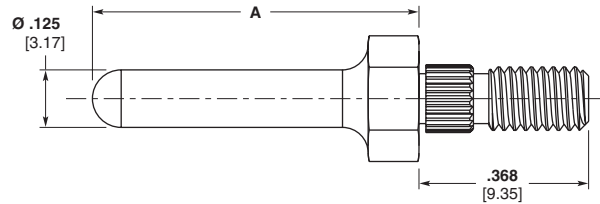

Electrical Performance

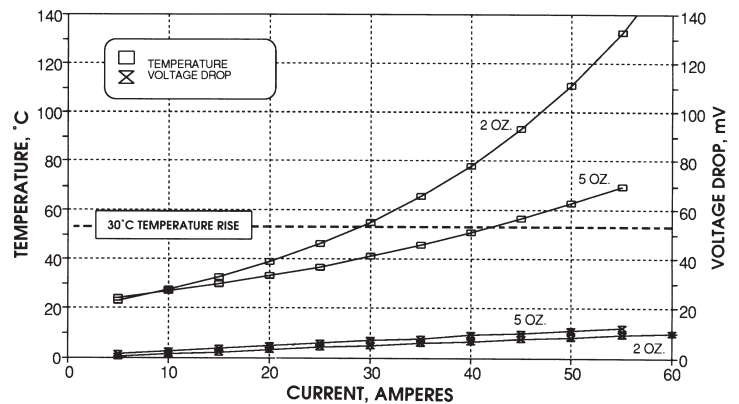
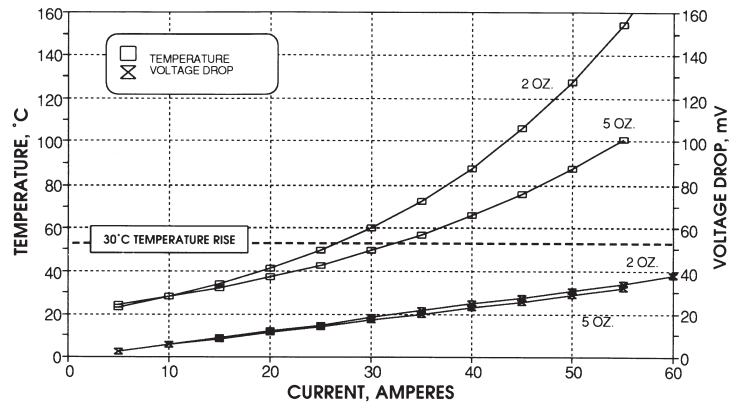

Note: All part numbers are RoHS compliant.

ICCON SLIMLINE Connectors (.100 x .100 Footprint)

Parallel Pin

Part Number 6643228-1 Solder
 Part Number 6643227-1 Solder w/Locking Feature
 Part Number 6643222-1 Compliant
 Part Number 6643223-1 Compliant w/ Locking Feature



Parallel Socket

Part Number 6643229-1 Solder
 Part Number 6643220-1 Press-Fit



Connector Mounting

The ICCON SLIMLINE Connector is optimized for a board thickness of .093" (2.38 mm), but can be successfully used on boards from .062" to .125" (1.58 mm to 3.17 mm)



Recommended PCB Layout (common for PCB and press fit tails)

Spacing between body and PCB

Specifications

Finishes	
Crowns	30 microinches Gold plated over nickel
Pin Contacts	Silver over nickel
Material	
Housing	Polyester, 30% glass-filled, UL 94V-0 black
Body and pin contacts	Copper alloy
Crowns	Copper alloy
Electrical	
Ratings UL (USR)	35A at 250V
UL (CNR)	25A at 250V
Voltage drop at UL rating	27.2mV

**Contact System Performance, ICCON SLIMLINE Connector
 Current Ratings vs. mV Drop/Temperature Rise**

Non-locking version, mounted on 2 oz. and 5 oz. copper boards

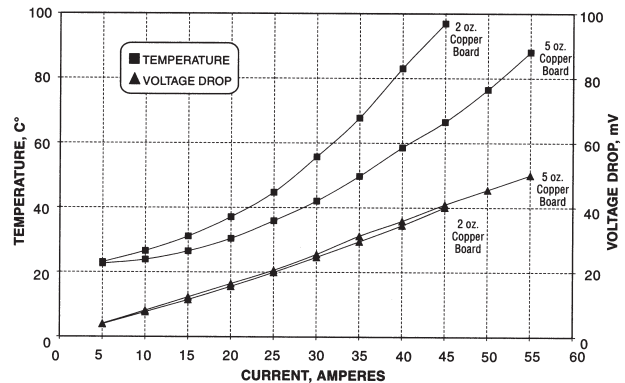

Note: All part numbers are RoHS compliant.

Mini Power Modules

Product Facts

- **Hard Metric design compatible with Z-PACK 2 mm HM, Z-PACK HM-Zd, MULTIGIG RT and Futurebus+ Connectors**
- **Sequenced contact options for “make-first-break-last” applications**
- **Compliant press-fit connections to PCB**
- **High Durability
200 Cycles — MULTIGIG RT, UPM Connectors
100 Cycles — Futurebus+ Connectors**
- **Optional Guide Pins & Sockets for blind-mate applications**
- **Bellcore approved (contact Tyco Electronics for specific part numbers)**
- **Recognized to US and Canadian requirements under the Component Recognition program of Underwriters Laboratories, File #E28476**
- **Produced under a Quality Management System certified to ISO 9001**

A copy of the certificate is available upon request.



The Tyco Electronics Mini Power Module family of products are designed specifically to compliment the Hard Metric board-to-board backplane interconnects. These products include, MULTIGIG RT, Z-PACK 2 mm HM, Z-PACK HM-Zd, Futurebus+ and other Connectors. Available in “Standard” and “Reverse” orientations, the power modules can provide touch-safe protection (per IEC 60950) to either side of the connection (backplane or daughter card.)

Both the headers and receptacle offer compliant pin connections to the PCB. The Universal Power Module and MULTIGIG RT Connectors use the ACTION PIN Contact compliant design to provide maximum surface connection to the plated through hole. The range of products offers power contacts rated as low as 3 amps per contact (Futurebus+ Connectors) up through

20 Amps per contact (MULTIGIG RT Connectors). In addition, the newest products offer high conductivity contacts which improve the current carrying capacity by as much as 50%.

The low contact normal force, available lubricated surface coating (UPM) and high conductivity materials combine to produce a high durability cycle rating and high current density. In addition, the high temperature housing and contact materials make these power modules suitable for a wide variety of applications including modular hot-swap power supplies used in computer, telecommunications, medical, and industrial equipment.

Generous alignment features designed into the housings on the Mini Power Drawer Connector and optional guidance hardware make these Power Modules ideal for blind-mating applications.

Need more information?

Call Technical Support at the numbers listed below.

Technical Support is staffed with specialists well versed in all Tyco Electronics products. They can provide you with:

- Technical Support
- Catalogs
- Technical Documents
- Product Samples
- Tyco Electronics Authorized Distributor Locations

Mini Power Modules for PCB-to-PCB Power Distribution

MULTIGIG RT Power Modules

The newest of the power modules. Designed specifically for use with Tyco Electronics 2 mm Backplane Connectors. Suitable for 0.8 mm Card Spacing and made from high conductivity copper alloys, these power modules offer improved power density and high cycle life. The distribution to the PCB is through **six ACTION PIN compliant tails** which offer maximum surface area contact to the plated through hole. The design offers electrical protection with its sacrificial contact design and mechanical protection by recessing the power contacts. Contacts are rated for up to 20 Amps per contact, which delivers up to **120 Amps per linear inch**. Three contact mating lengths are available, in 1.5 mm sequence levels.

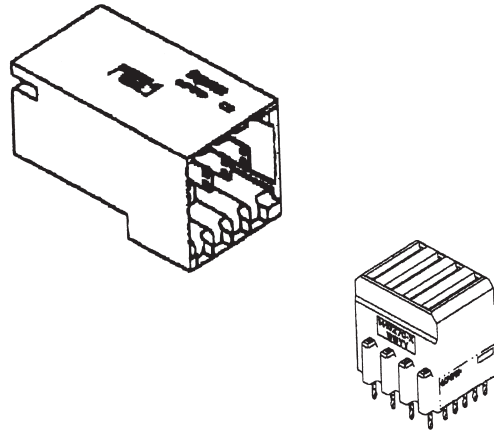

- Designed for Hot-Plug Operation
- 6 PCB tails per contact

Universal Power Module (UPM)

Also designed to complement Tyco Electronics 2 mm Backplane Connectors, the design meets IEC 60950 touch-safe requirements by reversing the orientation as compared to the Futurebus+ Power Modules. The touch-safe receptacle is applied to the "hot" side, which is typically the backplane side of the connection. Offered in both a Standard Power grade, rated at 10 Amps per contact and High Power grade which carries 16 Amps per contact — resulting in up to **100 Amps per linear inch**. Hot-plug design and low normal force provide high durability and high reliability. Three contact mating lengths are available in 1.6 mm sequence levels. Multiple contact sequence patterns are available.



- Lubricated for Environmental Protection
- Designed for Hot-Plug
- 4 PCB Tails per Contact

Z-PACK 2 mm Futurebus+ Power Modules

The power modules, designed to IEC 61076-4-OX, are used along with Tyco Electronics Futurebus+ Backplane Connectors. The contacts are rated for 3 Amps and fully loaded will carry approx. 50 Amps per linear inch. Three contact mating lengths available in 0.75 mm increments.



MULTIGIG RT Power Modules

Board-to-Board Products

Right-Angle Headers

Material and Finish

Housing — Liquid Crystal Polymer
Contacts — Phosphor Bronze
Plating — .000050 [0.00127] min gold in mating area. .000020 [0.000508] min. tin on PCB tail over .000050 [0.00127] min. nickel over all

Related Product Data

Guiding Hardware (Optional) — pages 58 and 59
Seating Tooling —
 Headers — No tool required
 — Flat Rock
 Receptacles — See application specification

Technical Documents

Product Specification
108-2062
Application Specification
114-13062



No. of Positions	Dimension X	Sequence	Part Number
2	.417 [10.6]	L,L	1410279-7
		M,L	1410279-8
		S,L	1410279-9
		S,S	1-1410279-0
		S,M	1-1410279-1
		M,M	1-1410279-2
4	.701 [17.8]	L,L,L,L	1-1410271-1
		M,L,L,M	1-1410271-2
		S,L,L,M	1-1410271-3
		S,L,L,S	1-1410271-4
		S,M,L,M	1-1410271-5
		M,M,M,M	1-1410271-6
		S,M,M,S	1-1410271-7
		S,S,S,S	1-1410271-8
		M,S,S,M	2-1410271-0

Sequencing reads left-to-right along mating face.
 L (long) = 0.541 [13.75], M (medium) = 0.482 [12.25], S (short) = 0.423 [10.75]

Vertical Receptacle

Material and Finish

Housing — Liquid Crystal Polymer
Contacts — Phosphor Bronze
Plating — 0.00127 (.000050) min gold in mating area. 0.000580 (.000020) min. tin on PCB tail over 0.00127 (.000050) min. nickel over all

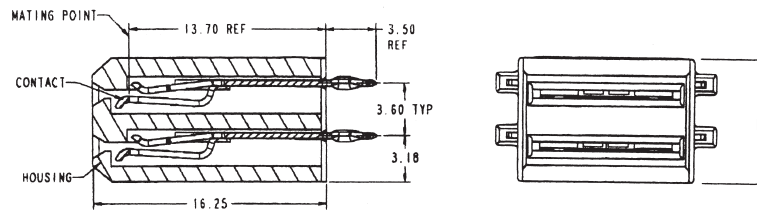

Related Product Data

Guiding Hardware (Optional) — pages 58 and 59
Seating Tooling —
 Headers — No tool required
 — Flat Rock
 Receptacles — See application specification

No. of Positions	Dimension L	Part Number
2	.333 [8.45]	1410278-2
4	.616 [15.65]	1410270-2

Technical Documents

Product Specification
108-2062
Application Specification
114-13062

Note: All part numbers are RoHS compliant.

Universal Power Module (UPM)

Right-Angle Plug

Material and Finish

Housing — PBT
Natural color UL 94V-0

Contacts —
Standard Power —
Phosphor Bronze

High Power —
High Conductivity Copper Alloy

Plating — 0.00127 [0.00050] min. gold in mating area, 0.0050 [0.00020] min. tin-lead on ACTION PIN post area, with entire contact underplated 0.00127 [0.00050] min. nickel

- Notes:** 1. Environmental lubrication pre-applied
2. RoHS compliant parts have tin plated ACTION PIN posts



Slim UPM Plug

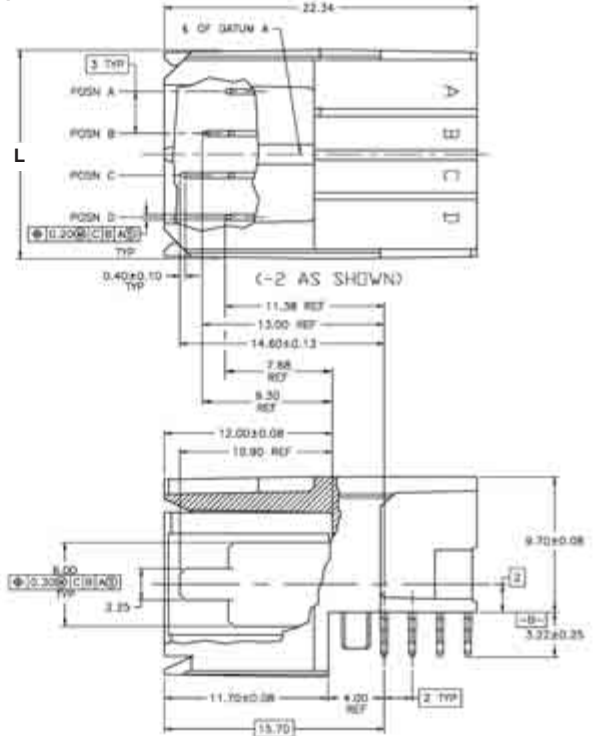

Related Product Data

- Durability** — 250 cycles
Guiding Hardware (Optional) — pages 58 and 59
Seating Tooling — Header
Seating Tool 224441-X
Board Support Fixture 224442-1
Receptacle
Seating Tool 224421-X
Board Support Fixture 217602-1

Technical Documents

- Product Specification**
108-1651
SLIM UPM Product Specification
108-78387
Application Specification
114-1103
Instruction Sheet
408-4169 (Receptacle)
Seating Tool 224421-X)

Number of Positions	Dimension L	Standard Power 10 Amps/Contact Sequence* Pattern	Part Number	High Power 16 Amps/Contact Sequence* Pattern	Part Number
3	.472 [12.0]	L,L,L	5223961-1	L,L,L	5-5223961-1
		M,L,M	5223963-1	M,L,M	5-5223963-1
4	.591 [15.0]	**	**	**	**
		L,L,L,L	5646954-1	L,L,L,L	120954-1
5	.709 [18.0]	S,M,L,S	5646954-2	L,M,S,S	120954-2
		**	**	**	**
6	.827 [21.0]	L,L,L,L,L	5646955-1	L,L,L,L,L	120955-1
		M,M,M,M,L	5646955-2	M,M,L,M,M	120955-2
7	.945 [24.0]	**	**	**	**
		L,L,L,L,L,L	5646956-1	L,L,L,L,L,L	120956-1
8	1.063 [27.0]	L,M,M,M,M,L	5646956-2	L,M,S,S,S,S	120956-2
		**	**	**	**
9	1.170 [29.7]	L,L,L,L,L,L,L	5646957-1	L,L,L,L,L,L,L	120957-1
		**	**	**	**
10	1.277 [32.4]	L,L,L,L,L,L,L,L	5646958-1	L,L,L,L,L,L,L,L	120958-1
		L,S,L,S,L,S,L,S	5646958-2	L,M,S,S,S,S,S,S	120958-2

*Sequencing Reads left-to-right along mating face.
L (long) = 0.429 [10.9], M (medium) = 0.366 [9.3], S [short] = 0.302 [7.68]
**Other sequence patterns available. See on-line customer drawing.

Slim UPM Right-Angle Plug

Number of Positions	Width	Part Number
4	0.335 [8.5]	1903977-1 1903977-2

Note: All part numbers are RoHS compliant.

Universal Power Module (UPM) (Continued)

Board-to-Board Products

Vertical Plug

Material and Finish

- Housing** — PBT
- Natural color UL 94V-0
- Contacts** —
- Standard Power** — Phosphor Bronze
- High Power** — High Conductivity Copper Alloy
- Plating** — 0.00127 [0.00050] min. gold in mating area, 0.0050 [0.00020] min. tin-lead on ACTION PIN post area, with entire contact underplated 0.00127 [0.00050] min. nickel
- Notes:** 1. Environmental lubrication pre-applied
- 2. RoHS compliant parts have tin plated ACTION PIN posts

Related Product Data

- Durability** — 250 cycles
- Guiding Hardware (Optional)** — pages 58 and 59
- Seating Tooling — Header**
- Seating Tool 224441-X
- Board Support Fixture 224442-1
- Receptacle**
- Seating Tool 224421-X
- Board Support Fixture 217602-1

Technical Documents

- Product Specification**
- 108-1651
- Application Specification**
- 114-1103



Recommended PCB Layout

Number of Positions	Dimension L	Part Numbers	
		15 mm Stack Height	18 mm Stack Height
3	.470 [11.95]	1645498-1	1645499-1
4	.589 [14.95]	1645498-2	1645499-2
5	.707 [17.95]	1645498-3	1645499-3
6	.825 [20.95]	1645498-4	1645499-4
7	.943 [23.95]	1645498-5	1645499-5
8	1.061 [26.95]	1645498-6	1645499-6
9	1.179 [29.95]	1645498-7	1645499-7

NEW

“NEW” Low Profile Universal Power Module

Material and Finish

- Housing** — LCP
- Contacts** — High Conductivity Copper Alloy
- Current Rating** — 18 Amps per contact

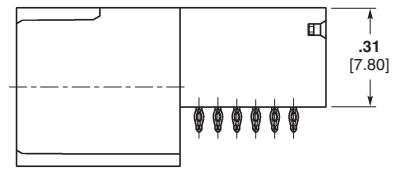

Right-Angle Plug
Part Number 1982260-5

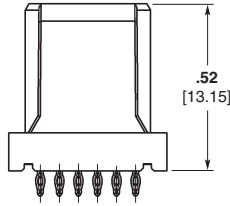

Vertical Receptacle
Part Number 1982257-5

Note: All part numbers are RoHS compliant.

Universal Power Module (UPM) (Continued)

Vertical and Right-Angle Receptacles

Material and Finish

Housing — PBT

Natural color

UL 94V-0

Contacts —

Standard Power —

Phosphor Bronze

High Power —

High Conductivity Copper Alloy

Plating — 0.00127 (.000050) min. gold in mating area, 0.0050 (.000020) min. tin-lead on ACTION PIN post area, with entire contact underplated 0.00127 (.000050) min. nickel

- Notes:** 1. Environmental lubrication pre-applied
2. RoHS compliant parts have tin plated ACTION PIN posts

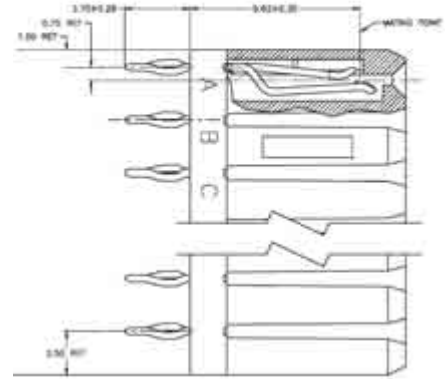
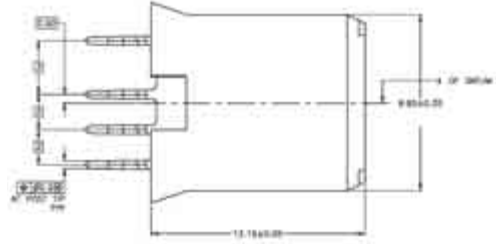

Related Product Data

Durability — 250 cycles

Mating Force — 1.0N per contact

Unmating Force — .5N per contact

Guiding Hardware (Optional) — pages 58 and 59

Seating Tooling —

Header

Seating Tool 224441-X

Board Support Fixture 224442-1

Receptacle

Seating Tool 224421-X

Board Support Fixture 217602-1

Technical Documents

Product Specification

108-1651 (UPM)

108-78387 (Slim UPM)

Application Specification

114-1103

Instruction Sheet

408-4169 (Receptacle)

Seating Tool 224421-X)

New short PCB tail available. Contact Tyco Electronics for more information.

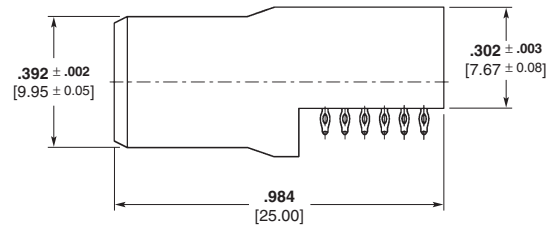
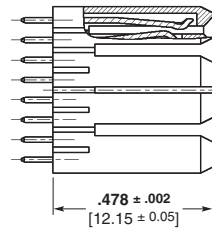

Right-Angle Part Number 120943

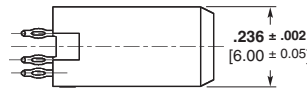

Part Number 1903978



Seating Tool

No. of Circuit Positions	Vertical		Right-Angle
	Standard Power 10 Amps/Contact Part Numbers	High Power 16 Amps/Contact Part Numbers	High Power 16 Amps/Contact Part Numbers
3	5223955-2	5-5223955-2	120943-1
4	5223995-1	120953-1	120943-2
5	5223995-2	120953-2	120943-3
6	5223995-3	120953-3	120943-4
7	5223995-4	120953-4	120943-5
8	5223995-5	120953-5	120943-6
9	5223995-6	120953-6	120943-7

Slim UPM Vertical Receptacle

Number of Positions	Width	Part Number
4	.236 [6.00]	1903978-1
		1903978-2

Note: All part numbers are RoHS compliant.

Z-PACK 2 mm Futurebus+ Power Modules

Vertical Pin Assemblies with Solder Leads and Compliant Press-Fit Leads

Material and Finish

Housing — Liquid crystal polymer

Pin Contacts — Phosphor bronze, mating surface plating conforms to all testing specified for Telcordia Uncontrolled Environment, with entire contact underplated with 0.00127 min. nickel. See customer drawing for specific lead plating.

Related Product Data

Current Rating — 5 Amps per contact

Mating Force — 2.4N per contact max.

Unmating Force — 0.3N per contact max.

Durability — 250 cycles

Technical Documents

Product Specification

108-1441

Application Specification

114-1075

Instruction Sheets

408-6927, 408-4157, 408-4488

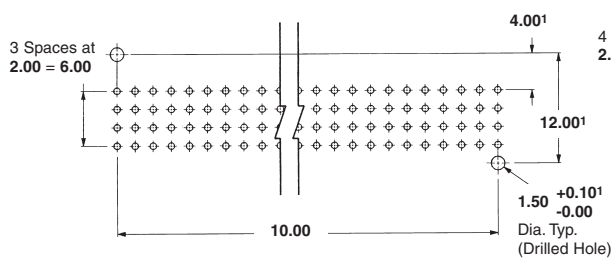
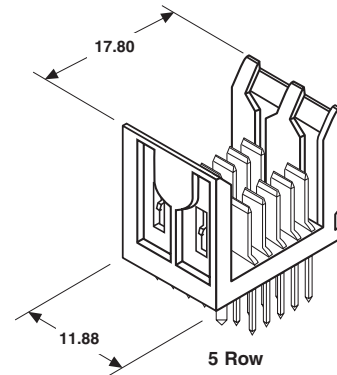

Recommended PC Board Hole Layout per IPC-D-300, Type II, Class C (Component Side)

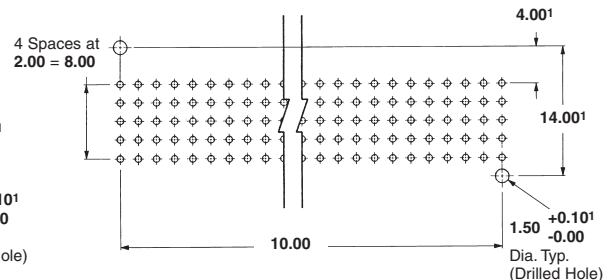

Recommended PC Board Hole Layout per IPC-D-300, Type II, Class C (Component Side)

¹Dimensions apply to solder lead versions only.

¹Dimensions apply to solder lead versions only.

Reference specification 114-1075 for plated through hole requirements.



Number of Positions	Mating Post Lengths	Part Numbers				
		4.25 Solder Lead	3.2 Solder Lead	Press-Fit	Housing Shroud	Seating Tooling
8	.256 [6.50]	5536600-1	5536628-1	5536603-1	536565-X	58512-1
	.285 [7.25]	5536625-1	—	—		
	.315 [8.00]	5536623-1	—	5536620-1		
10	.256 [6.50]	—	—	5536642-1	223041-X	1214224-1
	.315 [8.00]	—	—	5536642-7		

Note: All part numbers are RoHS compliant.

Z-PACK 2 mm Futurebus+ Power Modules (Continued)

Right-Angle Receptacle Assemblies with Solder Leads and Compliant Press-Fit Leads

Material and Finish

Housing — Liquid crystal polymer
Receptacle Contacts — Phosphor bronze, mating surface plating conforms to all testing specified for Telcordia Uncontrolled Environment, with entire contact underplated with 0.00127 min. nickel. See customer drawing for specific lead plating.

Technical Documents

Product Specification

108-1441

Application Specification

114-1075

Instruction Sheets

408-6927



4 Row



5 Row

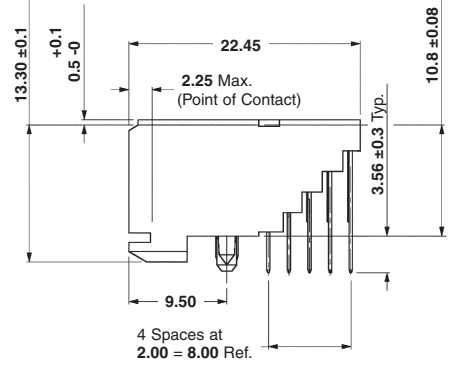

Recommended PC Board Hole Layout per IPC-D-300, Type II, Class C (Component Side)

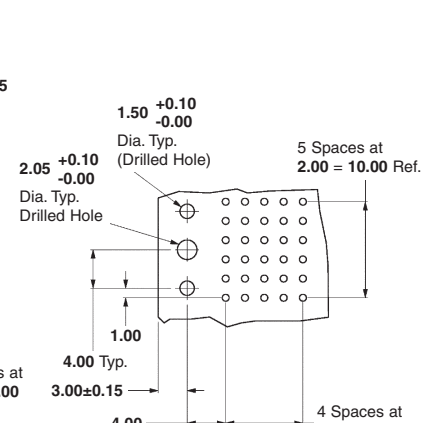

Recommended PC Board Hole Layout per IPC-D-300, Type II, Class C (Component Side)

Reference specification 114-1075 for plated through hole requirements.



Number of Positions	Part Numbers			Seating Tool
	Solder Tail Length		Press-Fit 0.140 [3.56]	
	0.107 [2.73]	0.139 [3.53]		
8	5536607-1	5536613-1	5536614-1	Industry Standard Flat Rock
10	5223092-1	5223093-1	5536649-1	Industry Standard Flat Rock

Note: All part numbers are RoHS compliant.

Backplane and Co-Planar Guide Modules

Un-keyed Guide Modules

Stainless Steel Pin
Die Cast Receptacle
Multiple thread lengths available
Gatherability +/-0.100"

Seating Tool — Part Number 224440-1
Board Support Fixture — Part Number 217603-1



Type	Dim. L	Part Number			
		Vertical Guide Pin	Right-Angle Guide Module	Vertical Guide Module	Vertical Spacer Module
M4, 6.2 mm Thread Length	1.235 [31.36]	223956-1			
M4, 7.5 mm Thread Length	1.269 [32.23]	223982-1			
M4, 12.7 mm Thread Length	1.491 [37.86]	223969-1			
8-32, 12.7 mm Thread Length	1.491 [37.86]	223969-4	5223979-1 (with Dual Mounting Position)	1934988-1	1645545-1 (15 mm)
M4, 9.2 mm Thread Length	1.353 [34.36]	223969-7			1645545-2 (18 mm)
M4, Internal Thread	1.378 [35.00]	1857988-1			

Keyed Guide Modules

Die Cast Pin and Receptacle
Keyed to prevent mis-mating daughter cards
Multiple thread lengths available
Gatherability +/-0.100"

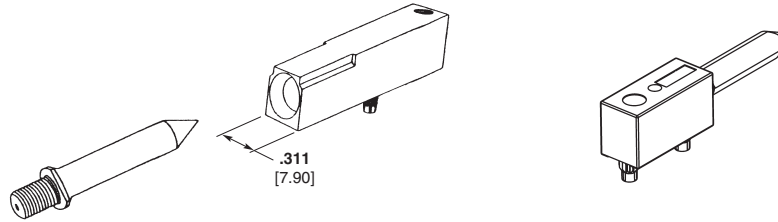

Type	Right-Angle Guide Module		Vertical Pin	Right-Angle Pin
	4-40	M2.5		
0°	5223986-1	5120913-1		1469265-1
90°	5223986-3	5120913-3		1469265-3
180°	5223986-5	5120913-5	5223985-1	1469265-5
225°	5223986-6	5120913-6		1469265-6

AdvancedTCA Guide Modules

Die Cast Pins and Receptacles
Keyed to prevent mis-mating daughter cards
Twin Pins — provide more keying options
Meets PICMG 3.0 Specifications
Gatherability +/-0.50"



Type	Part Number			AdvancedTCA Module Designation
	Both Pins Keyed 0°	Top Pin Keyed 270° Bottom Pin Keyed 90°	Not Keyed	
Right-Angle Pin Long	1-1469372-1	3-1469372-7	—	A2
Vertical Pin Short	1-1469387-1	3-1469387-7	—	A1
Vertical Pin Long	1-1469388-1	3-1469388-7	—	A2
Right-Angle Receptacle	1-1469373-1	3-1469373-7	1469374-1	K1/K2
Single Pin Rear Assembly	—	—	1469269-X*	rK1

*-X identified by PCB thickness. See customer drawing for details.

AdvancedTCA is a trademark of PICMG-PCI Industrial Computer Manufacturers Group, Inc.

Note: All part numbers are RoHS compliant.

Backplane and Co-Planar Guide Modules (Continued)

10.8 Guide Modules

Rugged design — to support heavier cards
 Better gatherability +/-3.5 mm
 10.8 mm width
 Die Cast Pin
 Die Cast Receptacle
 ESD Ground Option
 Finish: Nickel plated



Type	Part Number			
	Right-Angle		Vertical Pin	
	With ESD	Without ESD	Internal M3.5 Thread	External M5 Thread
0	1-1410297-1	1-1410546-1		
90	1-1410297-3	1-1410546-3		
180	1-1410297-5	1-1410546-5	1410548-3	1-1410773-2
225	1-1410297-6	1-1410546-6		

*See customer drawing for dash numbers

9.0 VITA 46 Guide Modules

Die Cast Pins and Receptacles
 Keyed to prevent mis-mating daughter cards
 Meets VITA 46 Specification
 Gatherability +/-3.5 mm
 Finish: Silver plated



Type	Part Number
Double-Ended	1410956-1

Type	Right-Angle*	Vertical Pin Thread Depth		
		10 mm	11.6 mm	13.1 mm
0°	1-1469492-1			
45°	1-1469492-2			
90°	1-1469492-3			
270°	1-1469492-7	1-1469491-2	1-1469491-3	1-1469491-4
315°	1-1469492-8			
Un-keyed	1-1469492-9			

*Mounting screw Part Number 1410946-X required

VITA 41 Guide Modules

Die Cast Pins and Receptacles
 Meets VITA 41 Specification
 Gatherability +/-2 mm
 Finish: Clear Chromate



Key	Part Number		
	Vertical Short Pin	Vertical Long Pin	Right-Angle Module
0°	1410962-1	1410963-1	1410465-1
270°	1410962-7	1410963-7	1410465-7

7.2 Thin Guide Modules

Die Cast Pin and Receptacle
 7.2 mm width
 Gatherability +/-2.5 mm
 Finish: Trivalent Chromium



Right-Angle	Part Number	
	Vertical Pin Thread Length	
	8.7 mm	11.6 mm
1410714-3	1-1410710-1	1-1410710-3

Note: All part numbers are RoHS compliant.

Z1 Power Connector for AdvancedTCA Zone 1 Applications

Product Facts

- Designed to PICMG 3.0 Standard
- High conductivity copper alloy on Size 16 power contacts
- .76 micro-meters [30 microinch] gold over 1.27 micrometers [50 microinch] nickel plating at contact interface
- Gold-thickness controlled on inside of socket and outside of pin — at contact interface points
- RoHS compliant
- Stainless steel spring provides contact normal force — resists relaxation at elevated temperatures
- Eye of the needle compliant press-fit termination
- No special tools needed to seat connectors to PCB — standard Flat-Rock seating tools
- Additional PCB retention hardware not required

Technical Documents

Product Specification

108-2216

Application Specification

114-13156

Industry Standard

PICMG 3.0, Rev. 2.0

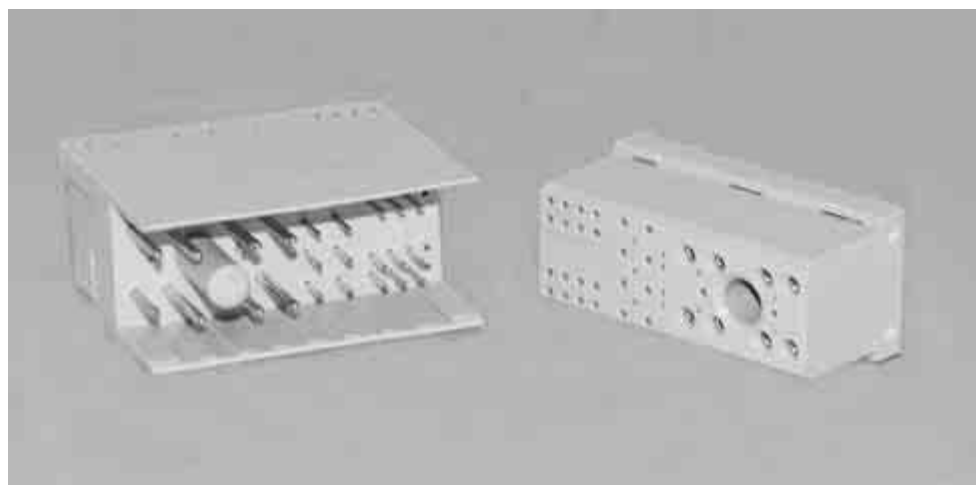

Introduction

Tyco Electronics supplies both the power and the signal connectors specified in the Advanced Telecommunications Computer Architecture (AdvancedTCA) Standard. This standard (PICMG 3.0) is one of the latest standards addressing future telecommunications needs. The AdvancedTCA Power Connector, designated for use in Zone 1 per PICMG 3.0, combines 8 High Conductivity Size 16 pin & socket contacts along with 22 Size 22 pin & socket contacts, plus guidance into a compact interface. Both connector halves feature proven compliant press-fit contacts for easy solder-less termination to printed circuit boards.

Based on years of reliable long-term field installations the power contact design is based upon Tyco Electronics' famous Type III+ contact design. By adding the use of a high conductivity copper alloy and the low-force Eye-Of-Needle compliant

pin section, the new contact delivers both ease of installation (with flat-rock seating tools) as well as industry-leading current carrying capability. The power contacts are capable of carrying 20 amps per contact and the signals are capable of carrying 2 amps per contact.

The housing design also offers improvements compared to other industry alternatives. The lead-in design for the contact cavities provides better resistance from contact stubbing. The contact retention has also been designed to eliminate the need for additional hardware sometimes used to hold the connectors to the PCB after pressing in to the PCB.

The result is a connector which is easy to install, meets all the PICMG 3.0 performance requirements and stays retained to the PCB without the additional labor required to add hardware.

Typical Electrical Properties

Current Ratings — tested in accordance with CSA C22.2 No. 182.3-M1987 and IEC 60512-3, Test 5a requirements:

Positions 1–24, 27, 32 — 1 Amp each, per the PICMG 3.0 Specification

Positions 25, 26, 28–31, and 34 — 20 Amps each, exceeds the PICMG 3.0 Specification

Dielectric Withstanding Voltage —

Positions 1–16 — 1000 Volts rms

Positions 17–24 — 2000 Volts rms

Positions 25–34 — 2000 Volts rms

Environmental Parameters

Maximum Continuous Operating Temperature — 105°C

Durability Rating — 250 cycles, per PICMG 3.0

AdvancedTCA and PICMG are trademarks of the PICMG-PCI Industrial Computer Manufacturers Group, Inc.

Z1 Power Connector for AdvancedTCA Zone 1 Applications (Continued)

Material and Finish

Insulators — Thermoplastic, glass reinforced, UL 94V-0

Signal Pins — Copper alloy

Power Contacts — High conductivity copper alloy, plated 0.00076 [.000030] min. gold in mating area over 0.00127 [.000050] min. nickel

Compliant PCB Tails — 0.0030 – 0.0043 [.000120 – .000170] tin plated, matte finish

Notes:

1. Mounting hardware — self tapping screw (customer supplied) can be used but not required on receptacle
2. Positions 1–4 not populated and reserved for future use for 308 22 position connectors.



Right-Angle Plug Part Number	Power Contacts	Signal Contacts	Tail Type
1766502-1	8	14	Sn Press-Fit
1766502-2			SnPb Press-Fit
1766500-1		22	Sn Press-Fit
1766500-2			SnPb Press-Fit
1888803-1		26	Sn Press-Fit
1888803-2			SnPb Press-Fit

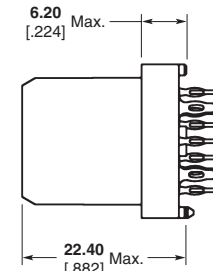

Vertical Receptacle Part Number	Power Contacts	Signal Contacts	Tail Type
1766503-1	8	14	Sn Press-Fit
1766503-2			SnPb Press-Fit
1766501-1		22	Sn Press-Fit
1766501-2			SnPb Press-Fit
1888804-1		26	Sn Press-Fit
1888804-2			SnPb Press-Fit

Note: All part numbers are RoHS compliant.

Компания «Life Electronics» занимается поставками электронных компонентов импортного и отечественного производства от производителей и со складов крупных дистрибьюторов Европы, Америки и Азии.

С конца 2013 года компания активно расширяет линейку поставок компонентов по направлению коаксиальный кабель, кварцевые генераторы и конденсаторы (керамические, пленочные, электролитические), за счёт заключения дистрибьюторских договоров

Мы предлагаем:

- Конкуренеспособные цены и скидки постоянным клиентам.
- Специальные условия для постоянных клиентов.
- Подбор аналогов.
- Поставку компонентов в любых объемах, удовлетворяющих вашим потребностям.
- Приемлемые сроки поставки, возможна ускоренная поставка.
- Доставку товара в любую точку России и стран СНГ.
- Комплексную поставку.
- Работу по проектам и поставку образцов.
- Формирование склада под заказчика.
- Сертификаты соответствия на поставляемую продукцию (по желанию клиента).
- Тестирование поставляемой продукции.
- Поставку компонентов, требующих военную и космическую приемку.
- Входной контроль качества.
- Наличие сертификата ISO.

В составе нашей компании организован Конструкторский отдел, призванный помогать разработчикам, и инженерам.

Конструкторский отдел помогает осуществить:

- Регистрацию проекта у производителя компонентов.
- Техническую поддержку проекта.
- Защиту от снятия компонента с производства.
- Оценку стоимости проекта по компонентам.
- Изготовление тестовой платы монтаж и пусконаладочные работы.



Тел: +7 (812) 336 43 04 (многоканальный)
Email: org@lifeelectronics.ru