

General Specifications

Electrical Capacity (Resistive Load)

Switching Rating:	100mA @ 5V DC
Nonswitching Rating:	100mA @ 50V DC

Other Ratings

Contact Resistance:	100 milliohms maximum; 30 milliohms maximum for contact point
Insulation Resistance:	1,000 megohms minimum @ 250V DC
Dielectric Strength:	250V AC minimum for 1 minute minimum
Mechanical Life:	10,000 detent operations minimum
Electrical Life:	10,000 detent operations minimum

Notes: A detent operation is one actuator position operation or stepping.

A cycle is one 360° rotation. 10,000 detent operations equal 625

cycles for hexadecimal devices or 1,000 cycles for decimal devices.

Nominal Operating Torque:	Metal Shaft: 0.009Nm for decimal devices; 0.011Nm for hexadecimal devices All other Actuator types: 0.008Nm for decimal devices; 0.01Nm for hexadecimal devices
Contact Timing:	Nonshorting

Materials & Finishes

Actuators:	Screwdriver and Plastic Shaft - Glass fiber reinforced polyamide (UL94V-0); Dial - Polyoxymethylene; Metal Shaft - Brass with nickel plating
Bushing :	Brass with nickel plating (for Metal Shaft model)
Outer Case:	Glass fiber reinforced PBT (for Metal Shaft model)
Housing & Base:	Glass fiber reinforced polyamide (UL94V-0)
Movable Contacts:	Copper alloy with gold plating
Stationary Contacts:	Phosphor bronze with gold plating
Terminals:	Phosphor bronze with gold plating
Terminal Cover:	Polyamide (Right angle model only)
Bracket:	Phosphor bronze with tin plating (for Metal Shaft model)

Environmental Data

Operating Temperature Range:	-25°C through +85°C (-13°F through +185°F)
Humidity:	90 ~ 95% humidity for 240 hours @ 40°C (104°F)
Vibration:	10 ~ 55Hz with peak-to-peak amplitude of 1.5mm traversing the frequency range & returning in 5 minutes; 3 right angled directions for 2 hours
Shock:	50G (490m/s ²) acceleration (tested in 6 right angled directions, with 5 shocks in each direction)

Processing

Soldering:	Wave Soldering Recommended. See Profile A in Supplement section. Note: During Wave Soldering process, set the switch to the following position: FR01FR10P, FR01FR16P, FR01KR10P, FR01KR16P, FR01SR10P, FR01SR16P, FR01AR10PB, FR01AR16PB, FR01AR10HB, FR01AR16HB: 0 position; FR01FC10P, FR01KC10P, FR01FC10H, FR01KC10H, FR01SC10P, FR01AC10PB, FR01AC10HB: 7 position; FR01FC16P, FR01KC16P, FR01FC16H, FR01KC16H, FR01SC16P, FR01AC16PB, FR01AC16HB: F position Manual Soldering: See Profile A in Supplement section.
Cleaning:	These devices are not process sealed. Hand clean locally using alcohol based solution. Custom process sealed version available; contact factory.

Standards & Certifications

Flammability Standards:	UL94V-0 rated actuator, housing and base The FR01 Series rotaries have not been tested for UL recognition or CSA certification. These switches are designed for use in a low-voltage, low-current circuit. When used as intended, the results do not produce hazardous energy.
--------------------------------	---

Distinctive Characteristics

Compact dimensions and low profile allow high density mounting and close stacking of PC boards.

Highly visible legends and choice of screwdriver, shaft or dial actuators with arrow position indication provide trouble-free code setting. Knob actuator also available.

Real or complement code setting identified by color-keyed actuator.

Detent mechanism gives crisp, positive action for accurate switch setting.

Crimped terminals ensure secure PC mounting and prevent dislodging during soldering.

Cam activated movable contact and gold contacts assure contact reliability and continuity.

Surface mount model with screwdriver actuation available and shown in the surface mount section.

Contact factory for custom models with .200" (5.08mm) terminal spacing.

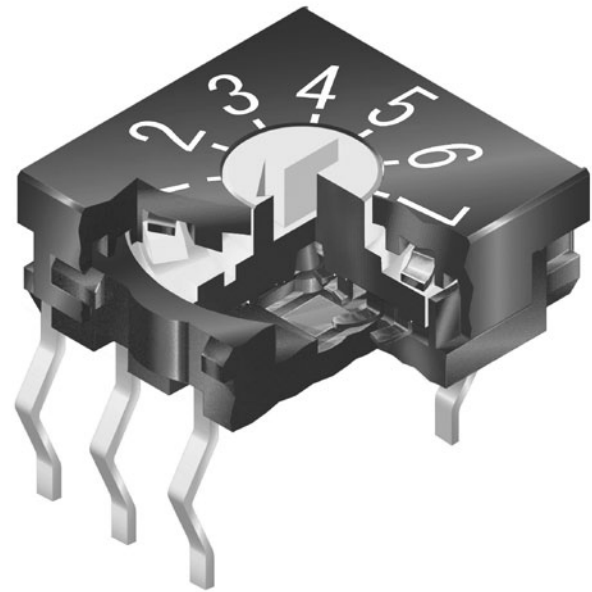

Actual Size

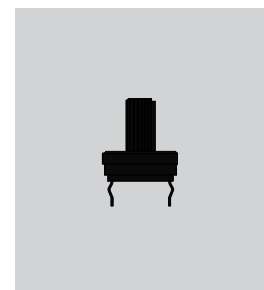

- Toggle
- Rockers
- Pushbuttons
- Illuminated PB
- Programmable
- Keylocks
- Rotaries**
- Slides
- Tactiles
- Tilt
- Touch
- Indicators
- Accessories
- Supplement

TYPICAL SWITCH ORDERING EXAMPLE

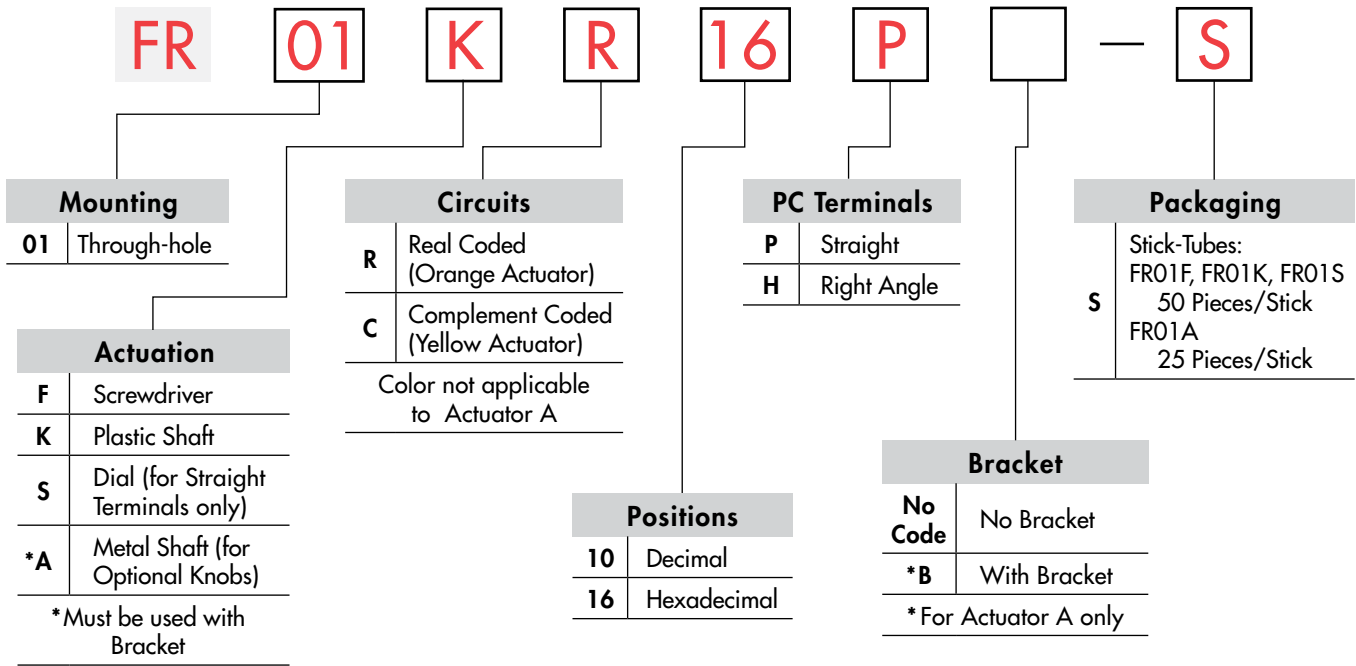

DESCRIPTION FOR TYPICAL ORDERING EXAMPLE

FR01KR16P-S

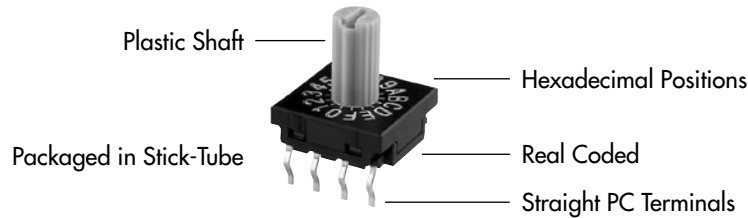

MOUNTING

01 Through-hole

ACTUATION

F Screwdriver

Adjusted with a flat tipped screwdriver

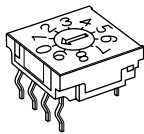

Actuators are fully rotational either clockwise or counterclockwise.
Actuator Colors: Orange for real coded devices; Yellow for complement coded devices.

AT4180
Optional Snap-on Knob

Polyamide
Black knob with transparent flange

Install knob before mounting on PCB for right angle type; it should not be removed once mounted. When mounting, align slit in knob with arrowhead on actuator.

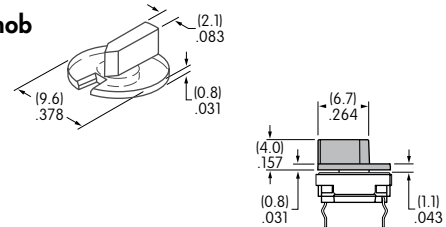

ACTUATION

K Plastic Shaft

Adjusted by hand or with flat tipped screwdriver

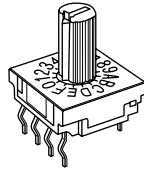

S Dial

Adjusted by hand or with flat tipped screwdriver



A Metal Shaft

Knob options illustrated below with color choices



Actuators are fully rotational and operate either clockwise or counterclockwise.
Colors for Actuators K and S: Orange for real coded devices; Yellow for complement coded devices

Mounting hardware is available if needed for models with Actuator A:
Hexagon Nut AT513M, Locking Ring AT515M, and Lockwasher AT509; all are shown in the Accessories and Hardware section.

OPTIONAL KNOBS FOR METAL SHAFT

AT433
Plain Black

Material:
Polyacetal

Color:
Black

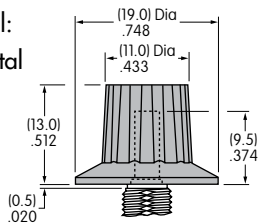

AT4103 Small
Color Tipped

Polyester Base:
Black

Polyamide Tip
Colors:
A, B, C, E, F, G, H



AT4104 Large
Color Tipped

Polyester Base:
Black

Polyamide Tip
Colors:
A, B, C, E, F, G, H

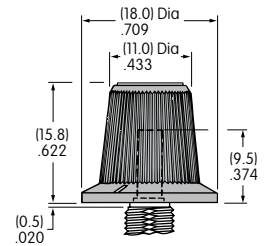

Knob Orientation: When installed with shaft flat rotated 180° from bushing flat as shown in "Typical Switch Dimensions," white line on cap points to Actuator Position 0 noted in truth tables below.

Color Codes: A Black B White C Red E Yellow F Green G Blue H Gray

TRUTH TABLES (CIRCUITS & POSITIONS)

Terminal No. (Output)	Actuator Position ● = ON	10 Decimal									16 Hexadecimal																				
		0	1	2	3	4	5	6	7	8	9	0	1	2	3	4	5	6	7	8	9	A	B	C	D	E	F				
R Real Coded Model Numbers: FR01FR, FR01KR, FR01SR, FR01AR	1		●		●		●		●		●		●		●		●		●		●		●		●		●				
	2			●		●		●		●		●		●		●		●		●		●		●		●		●			
	4				●		●		●		●		●		●		●		●		●		●		●		●		●		
	8					●		●		●		●		●		●		●		●		●		●		●		●		●	
C Complement Coded Model Numbers: FR01FC, FR01KC FR01SC, FR01AC	1	●		●		●		●		●		●		●		●		●		●		●		●		●		●			
	2	●	●		●	●		●	●		●	●		●	●		●	●		●	●		●	●		●	●		●		
	4	●	●	●	●		●	●	●		●	●	●		●	●	●		●	●	●		●	●	●		●	●		●	
	8	●	●	●	●	●	●		●	●	●	●		●	●	●	●		●	●	●	●		●	●	●	●		●	●	

Terminal numbers are actually on the switch.
Above sequence shown for clockwise rotation.

Toggles
Rockers
Pushbuttons
Illuminated PB
Programmable
Keylocks
Rotaries
Slides
Tactiles
Tilt
Touch
Indicators
Accessories
Supplement

TYPICAL SWITCH DIMENSIONS

P Straight PC • Screwdriver



H Right Angle PC • Screwdriver

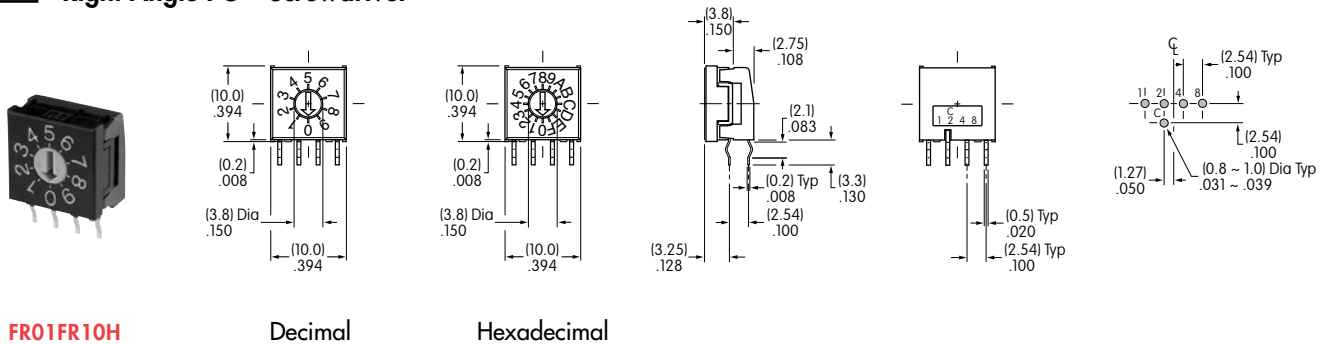

P Straight PC • Plastic Shaft



H Right Angle PC • Plastic Shaft



TYPICAL SWITCH DIMENSIONS

Straight PC • Dial

P

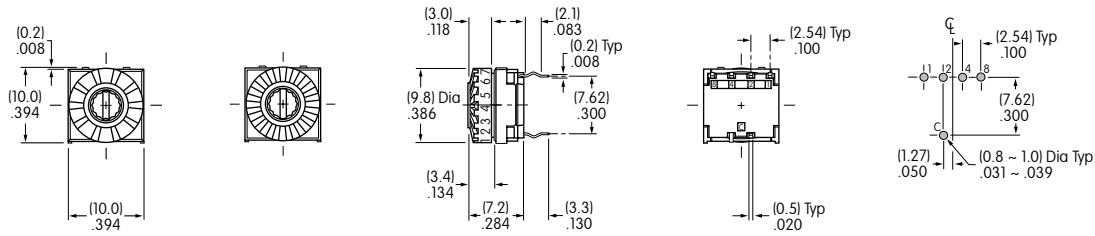

Decimal

Hexadecimal



FR01SR10P

Straight PC • Metal Shaft

P

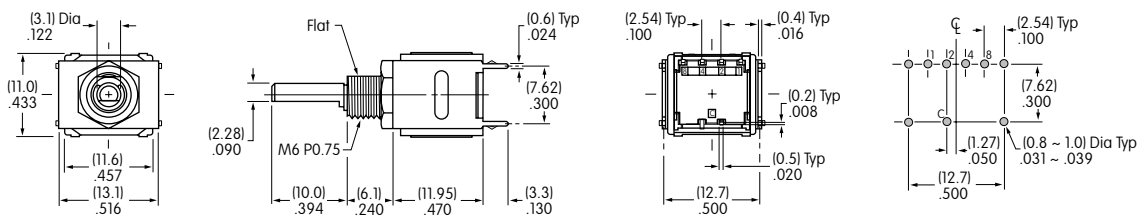

Shown in Position 0 with shaft flat rotated 180° from bushing flat



FR01AR10PB

Right Angle PC • Metal Shaft

H

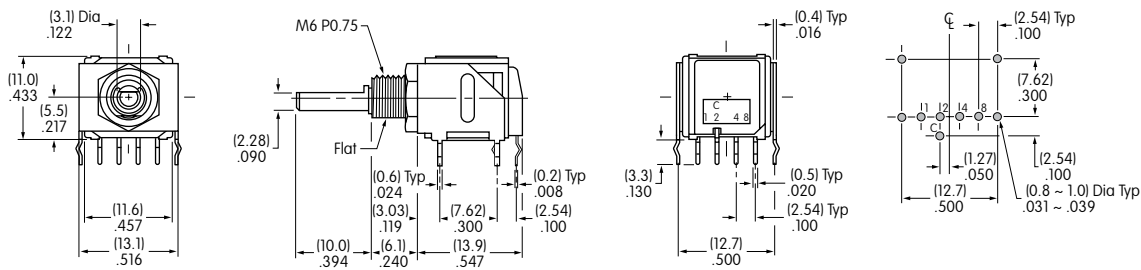

Shown in Position 0 with shaft flat rotated 180° from bushing flat



FR01AC16HB

PACKAGING

S

Stick-Tube

FR01F, FR01K & FR01S

Each stick-tube contains 50 switches.
Switches must be ordered in 50-piece increments.

FR01A

Each stick-tube contains 25 switches.
Switches must be ordered in 25-piece increments.

Note: Transport and storage temperatures should not exceed 50°C (122°F). Store stick tubes on flat surface.



FR01F with Screwdriver Actuation & Straight PC

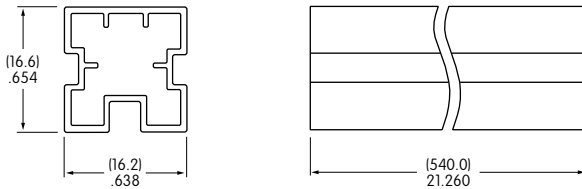

FR01K with Plastic Shaft & Right Angle PC

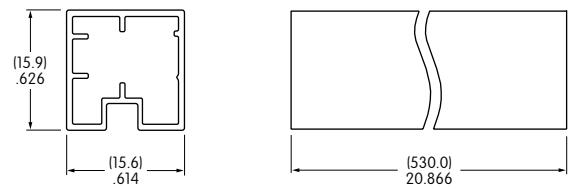

FR01S with Dial Actuation & Straight PC

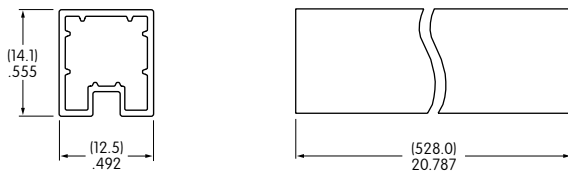

FR01A with Metal Shaft & Straight PC

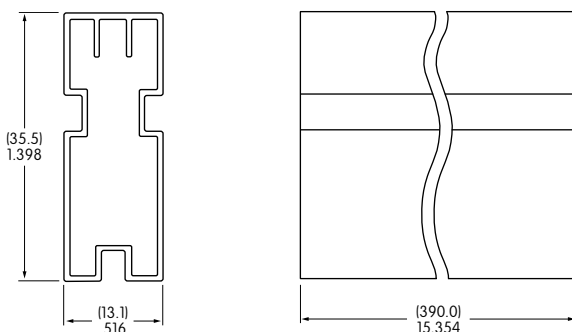

FR01A with Metal Shaft & Right Angle PC

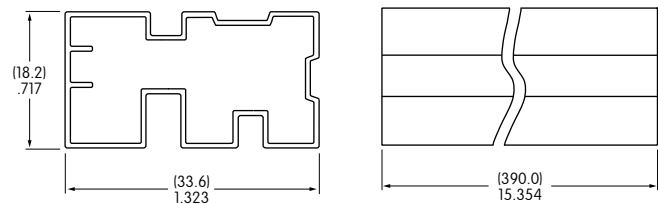

Toggles

Rockers

Pushbuttons

Programmable Illuminated PB

Keylocks

Rotaries

Slides

Tactiles

Tilt

Touch

Indicators

Accessories

Supplement

Компания «Life Electronics» занимается поставками электронных компонентов импортного и отечественного производства от производителей и со складов крупных дистрибьюторов Европы, Америки и Азии.

С конца 2013 года компания активно расширяет линейку поставок компонентов по направлению коаксиальный кабель, кварцевые генераторы и конденсаторы (керамические, пленочные, электролитические), за счёт заключения дистрибьюторских договоров

Мы предлагаем:

- Конкурентоспособные цены и скидки постоянным клиентам.
- Специальные условия для постоянных клиентов.
- Подбор аналогов.
- Поставку компонентов в любых объемах, удовлетворяющих вашим потребностям.
- Приемлемые сроки поставки, возможна ускоренная поставка.
- Доставку товара в любую точку России и стран СНГ.
- Комплексную поставку.
- Работу по проектам и поставку образцов.
- Формирование склада под заказчика.
- Сертификаты соответствия на поставляемую продукцию (по желанию клиента).
- Тестирование поставляемой продукции.
- Поставку компонентов, требующих военную и космическую приемку.
- Входной контроль качества.
- Наличие сертификата ISO.

В составе нашей компании организован Конструкторский отдел, призванный помогать разработчикам, и инженерам.

Конструкторский отдел помогает осуществить:

- Регистрацию проекта у производителя компонентов.
- Техническую поддержку проекта.
- Защиту от снятия компонента с производства.
- Оценку стоимости проекта по компонентам.
- Изготовление тестовой платы монтаж и пусконаладочные работы.



Тел: +7 (812) 336 43 04 (многоканальный)

Email: org@lifeelectronics.ru