

**PLEASE CHECK WWW.MOLEX.COM FOR LATEST PART INFORMATION**

**Part Number:** [0877153919](#)

**Status:** **Active**

**Overview:**

**Description:** 1.00mm (.039") Pitch, PCI Express\* Connector, 280 Circuits, Nylon 4/6 Glass-filled, Black Housing, Phosphor Bronze, 0.76µm (30µ") Gold (Au) Plating, with Plastic Pegs, 2.54mm (.100") Solder tail, Lead Free

**Agency Certification**

CSA LR19980

**General**

Product Family Edge Card Connectors  
Series 87715  
Component Type Edgecard to PCB  
Overview pci\_express\_card\_edge\_connector  
Product Name PCI Express\*

**Physical**

Circuits (Loaded) 280  
Circuits (maximum) 280  
Circuits Detail All Signal  
Durability (mating cycles max) 50  
Entry Angle Vertical (Top Entry)  
Flammability 94V-0  
Keying to Mating Part Yes  
Material - Plating Mating Gold  
Material - Plating Termination Tin  
PC Tail Length (in) 0.100 In  
PC Tail Length (mm) 2.54 mm  
PCB Locator Yes  
PCB Retention Yes  
PCB Thickness Recommended (in) 0.062 In  
PCB Thickness Recommended (mm) 1.60 mm  
Packaging Type Tray  
Pitch - Mating Interface (in) 0.039 In  
Pitch - Mating Interface (mm) 1.00 mm  
Pitch - Term. Interface (in) 0.039 In  
Pitch - Term. Interface (mm) 1.00 mm  
Plating min: Mating (µin) 30  
Plating min: Mating (µm) 0.76  
Polarized to Mating Part Yes  
Temperature Range - Operating 65°C  
Termination Interface: Style Through Hole

**Electrical**

Current - Maximum per Contact 1.1A  
Voltage - Maximum 50V AC (RMS)/DC

**Solder Process Data**

Lead-free Process Capability Wave Capable (TH only)  
Process Temperature max. C 260

**Material Info**

**Reference - Drawing Numbers**

Packaging Specification PK-87715-206  
Product Specification PS-87715-206

**EU RoHS**

**ELV and RoHS  
Compliant**

**REACH SVHC**

Not Reviewed

**Halogen-Free**

**Status**

**Not Reviewed**

**China RoHS**



**Need more information on product  
environmental compliance?**

Email [productcompliance@molex.com](mailto:productcompliance@molex.com)  
For a multiple part number RoHS Certificate of  
Compliance, [click here](#)

Please visit the [Contact Us](#) section for any  
non-product compliance questions.

**Search Parts in this Series**

87715Series

**Mates With**

PCI Express Card

Sales Drawing  
Test Summary

SD-87715-206  
TS-87715-206

\* PCI Express is a registered trademark of PCI-SIG®

This document was generated on 06/04/2010

**PLEASE CHECK [WWW.MOLEX.COM](http://WWW.MOLEX.COM) FOR LATEST PART INFORMATION**

7 6 5 4 3 2 1

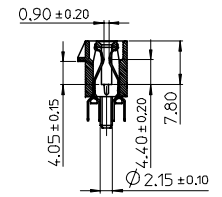
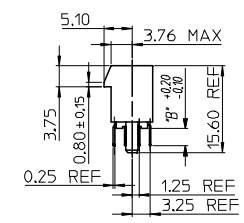
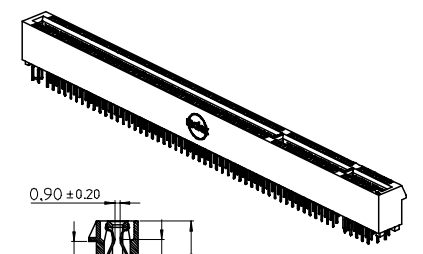
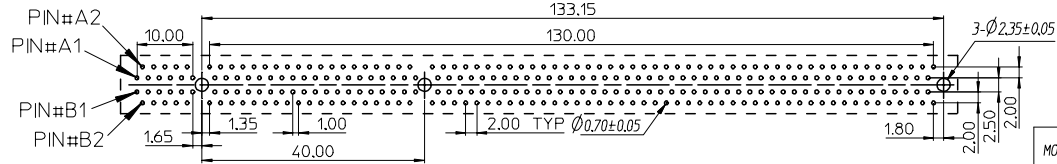
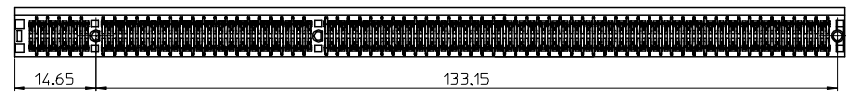
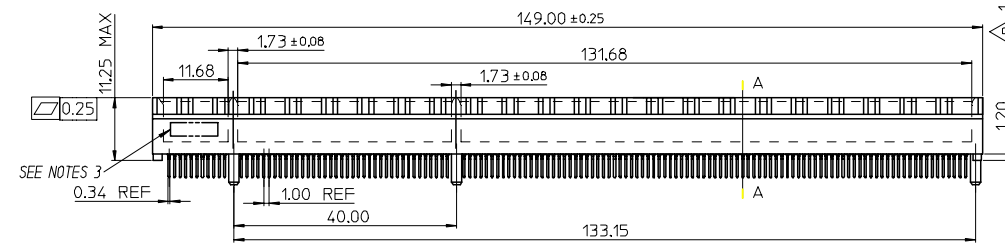
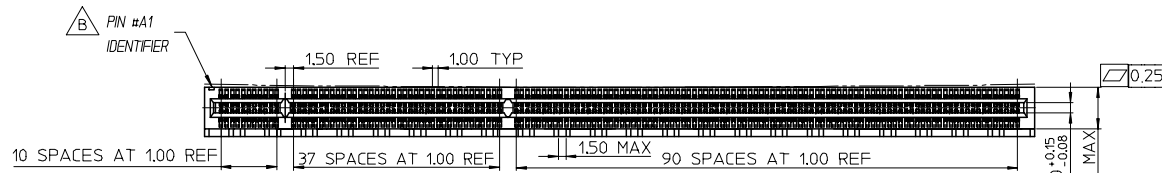

SECTION A-A

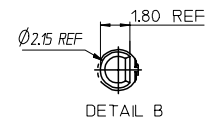

MOLEX PIN	CIRCUIT SIZE	HOUSING MATERIAL	HOUSING COLOR	TERMINAL MATERIAL	CONTACT PLATING	SOLDERTAIL PLATING	DIMB*
87715-3914	280	NYLON 46	BLACK	PHOSPHOR BRONZE	GOLD FLASH	100 MICRINCH TIN OVER 50 MICRINCH NICKEL OVERALL	3.00
87715-3915	280	NYLON 46	BLACK	PHOSPHOR BRONZE	15 MICRINCH	100 MICRINCH TIN OVER 50 MICRINCH NICKEL OVERALL	3.00
87715-3916	280	NYLON 46	BLACK	PHOSPHOR BRONZE	30 MICRINCH	100 MICRINCH TIN OVER 50 MICRINCH NICKEL OVERALL	3.00
87715-3917	280	NYLON 46	BLACK	PHOSPHOR BRONZE	GOLD FLASH	100 MICRINCH TIN OVER 50 MICRINCH NICKEL OVERALL	2.54
87715-3918	280	NYLON 46	BLACK	PHOSPHOR BRONZE	15 MICRINCH	100 MICRINCH TIN OVER 50 MICRINCH NICKEL OVERALL	2.54
87715-3919	280	NYLON 46	BLACK	PHOSPHOR BRONZE	30 MICRINCH	100 MICRINCH TIN OVER 50 MICRINCH NICKEL OVERALL	2.54

- NOTES:
- 1.MATERIALS:  
1-1.HOUSING:SEE TABLE GLASS FIBER FILLED UL94V-0  
COLOR:SEE TABLE  
1-2.CONTACT:SEE TABLE
  - 2.PLATING:  
2-1.CONTACT AREA:SEE TABLE  
2-2.SOLDER TAIL:SEE TABLE  
2-3.UNDER PLATING:SEE TABLE
  - 3.DATE CODE:TO BE PRINTED
  - 4.PRODUCT SPECIFICATION REFER TO PS-87715-200
  - 5.PACKAGE SPECIFICATION REFER TO PK-87715-206
  - 6.TEST SUMMARY:REFER TO TS-87715-206
  - 7.LEAD FREE AND ROHS COMPLIANT.

EWR 2006-0005 & 2006-0019 2005-0094 EC NO: SH2006-0100 DRWN:ALL IN 2006/05/15 CHKD: 2006/05/15 APPR:WWSCHANG 2006/05/16	QUALITY SYMBOLS ▽=0 ▽=0	GENERAL TOLERANCES (UNLESS SPECIFIED)		DIMENSION STYLE MM ONLY		SCALE	DESIGN UNITS METRIC	THIRD ANGLE PROJECTION	
			mm	INCH	DRAWN BY	DATE	TITLE		
		4 PLACES	± ---	± ---	TOM	2005/03/22	1.0 EDGE CARD 280 CKT VERTICAL DIP CONNECTOR (LEAD FREE VERSION)		
		3 PLACES	± ---	± ---	CHECKED BY	DATE			
2 PLACES	± 0.25	± ---	ALL IN	2005/03/22					
1 PLACE	± 0.25	± ---	APPROVED BY	DATE					
ANGULAR ± 3 °				WWSCHANG	2005/03/22	MOLEX INCORPORATED			
DRAFT WHERE APPLICABLE MUST REMAIN WITHIN DIMENSIONS				MATERIAL NO.	DOCUMENT NO.	SHEET NO.			
				SEE TABLE	SD-87715-206	1 OF 2			
				SIZE	THIS DRAWING CONTAINS INFORMATION THAT IS PROPRIETARY TO MOLEX INCORPORATED AND SHOULD NOT BE USED WITHOUT WRITTEN PERMISSION				
				A 4					

6 5 4 3 2 1

7 6 5 4 3 2 1

E

D

C

B

A

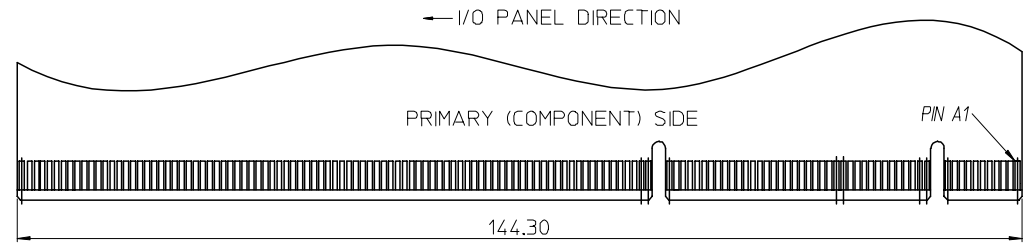
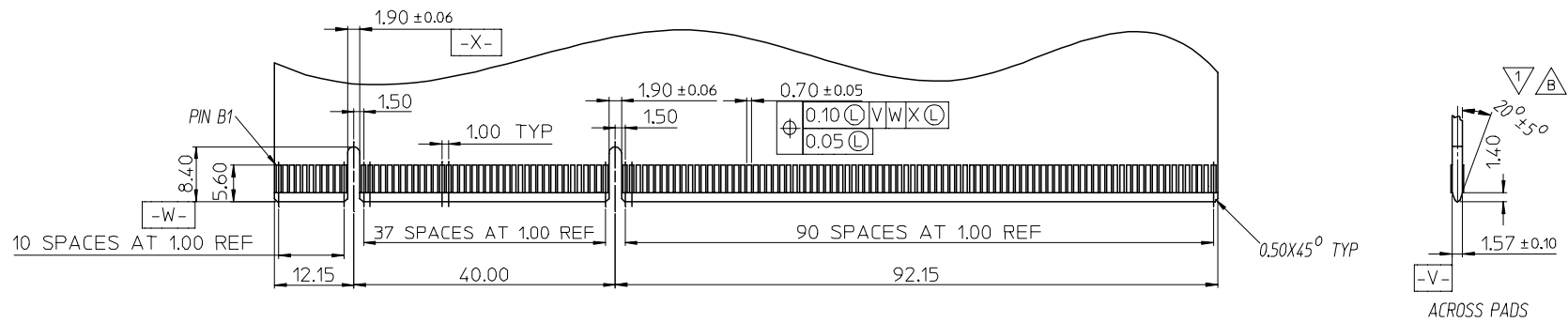

△ I/O PANEL → DIRECTION  
DAUGHTER CARD  
SECONDARY (SOLDER) SIDE

△ CHAMFER EDGES MUST BE FREE OF CUTTING BURRS.

SEE SHEET 1 EC NO: SH2006-0100 DRWN: ALL IN CHKD: APPR: WWSCHANG 2006/05/15 2006/05/15 2006/05/16	QUALITY SYMBOLS	GENERAL TOLERANCES (UNLESS SPECIFIED)		DIMENSION STYLE		SCALE	DESIGN UNITS	THIRD ANGLE PROJECTION	
	▽ = 0 ◻ = 0	mm	INCH	MM ONLY		1:1	METRIC		
		4 PLACES ± ---	± ---	DRAWN BY	DATE	TITLE			
		3 PLACES ± ---	± ---	TOM	2005/03/22	1.0 EDGE CARD 280 CKT VERTICAL DIP CONNECTOR (LEAD FREE VERSION)			
		2 PLACES ± 0.25	± ---	CHECKED BY	DATE	MOLEX INCORPORATED			
	1 PLACE ± 0.25	± ---	ALL IN	2005/03/22					
	ANGULAR ± 3 °	DRAFT WHERE APPLICABLE MUST REMAIN WITHIN DIMENSIONS		APPROVED BY	DATE	DOCUMENT NO.		SHEET NO.	
				WWSCHANG	2005/03/22	SD-87715-206		2 OF 2	
				MATERIAL NO.	SEE TABLE				
				SIZE	THIS DRAWING CONTAINS INFORMATION THAT IS PROPRIETARY TO MOLEX INCORPORATED AND SHOULD NOT BE USED WITHOUT WRITTEN PERMISSION				
				△ 4					

6 5 4 3 2 1

Компания «Life Electronics» занимается поставками электронных компонентов импортного и отечественного производства от производителей и со складов крупных дистрибьюторов Европы, Америки и Азии.

С конца 2013 года компания активно расширяет линейку поставок компонентов по направлению коаксиальный кабель, кварцевые генераторы и конденсаторы (керамические, пленочные, электролитические), за счёт заключения дистрибьюторских договоров

Мы предлагаем:

- Конкурентоспособные цены и скидки постоянным клиентам.
- Специальные условия для постоянных клиентов.
- Подбор аналогов.
- Поставку компонентов в любых объемах, удовлетворяющих вашим потребностям.
- Приемлемые сроки поставки, возможна ускоренная поставка.
- Доставку товара в любую точку России и стран СНГ.
- Комплексную поставку.
- Работу по проектам и поставку образцов.
- Формирование склада под заказчика.
- Сертификаты соответствия на поставляемую продукцию (по желанию клиента).
- Тестирование поставляемой продукции.
- Поставку компонентов, требующих военную и космическую приемку.
- Входной контроль качества.
- Наличие сертификата ISO.

В составе нашей компании организован Конструкторский отдел, призванный помогать разработчикам, и инженерам.

Конструкторский отдел помогает осуществить:

- Регистрацию проекта у производителя компонентов.
- Техническую поддержку проекта.
- Защиту от снятия компонента с производства.
- Оценку стоимости проекта по компонентам.
- Изготовление тестовой платы монтаж и пусконаладочные работы.



Тел: +7 (812) 336 43 04 (многоканальный)

Email: [org@lifeelectronics.ru](mailto:org@lifeelectronics.ru)