

74HC75

Quad bistable transparent latch

Rev. 4 — 24 February 2016

Product data sheet

1. General description

The 74HC75 is a quad bistable transparent latch with complementary outputs. Two latches are simultaneously controlled by one of two active HIGH enable inputs (LE12 and LE34). When LEnn is HIGH, the data enters the latches and appears at the nQ outputs. The nQ outputs follow the data inputs (nD) as long as LEnn is HIGH (transparent). The data on the nD inputs one set-up time prior to the HIGH-to-LOW transition of the LEnn will be stored in the latches. The latched outputs remain stable as long as the LEnn is LOW. Inputs include clamp diodes. This enables the use of current limiting resistors to interface inputs to voltages in excess of V_{CC} .

2. Features and benefits

- Complementary Q and \bar{Q} outputs
- V_{CC} and GND on the center pins
- Low-power dissipation
- Complies with JEDEC standard no. 7A
- Input levels:
 - ◆ For 74HC75: CMOS level
- ESD protection:
 - ◆ HBM EIA/JESD22-A114F exceeds 2000 V
 - ◆ MM EIA/JESD22-A115-A exceeds 200 V
- Multiple package options
- Specified from -40 °C to $+80\text{ °C}$ and from -40 °C to $+125\text{ °C}$.

3. Ordering information

Table 1. Ordering information

Type number	Package			
	Temperature range	Name	Description	Version
74HC75D	-40 °C to $+125\text{ °C}$	SO16	plastic small outline package; 16 leads; body width 3.9 mm	SOT109-1
74HC75DB	-40 °C to $+125\text{ °C}$	SSOP16	plastic shrink small outline package; 16 leads; body width 5.3 mm	SOT338-1
74HC75PW	-40 °C to $+125\text{ °C}$	TSSOP16	plastic thin shrink small outline package; 16 leads; body width 4.4 mm	SOT403-1

4. Functional diagram

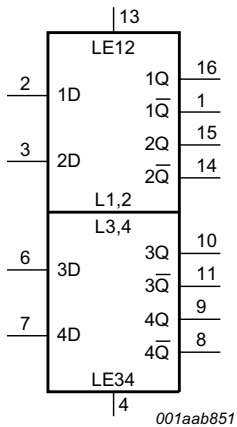

Fig 1. Logic symbol

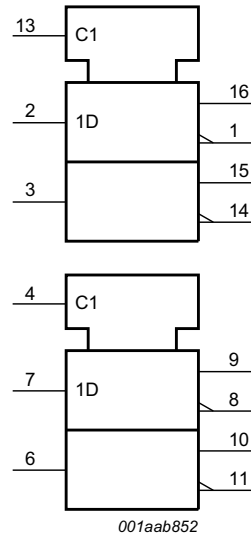

Fig 2. IEC logic symbol

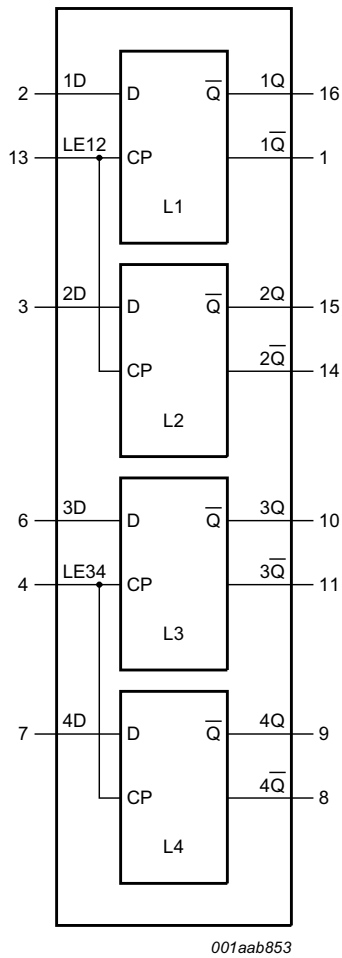

Fig 3. Functional diagram

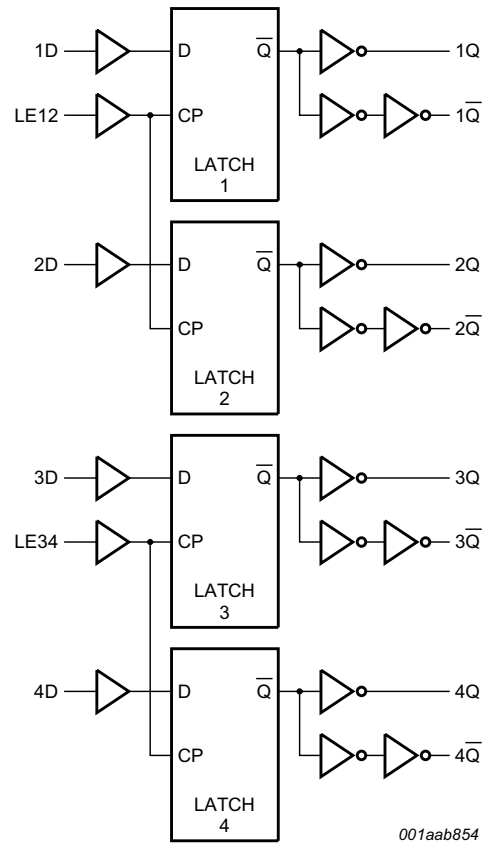

Fig 4. Logic diagram

5. Pinning information

5.1 Pinning

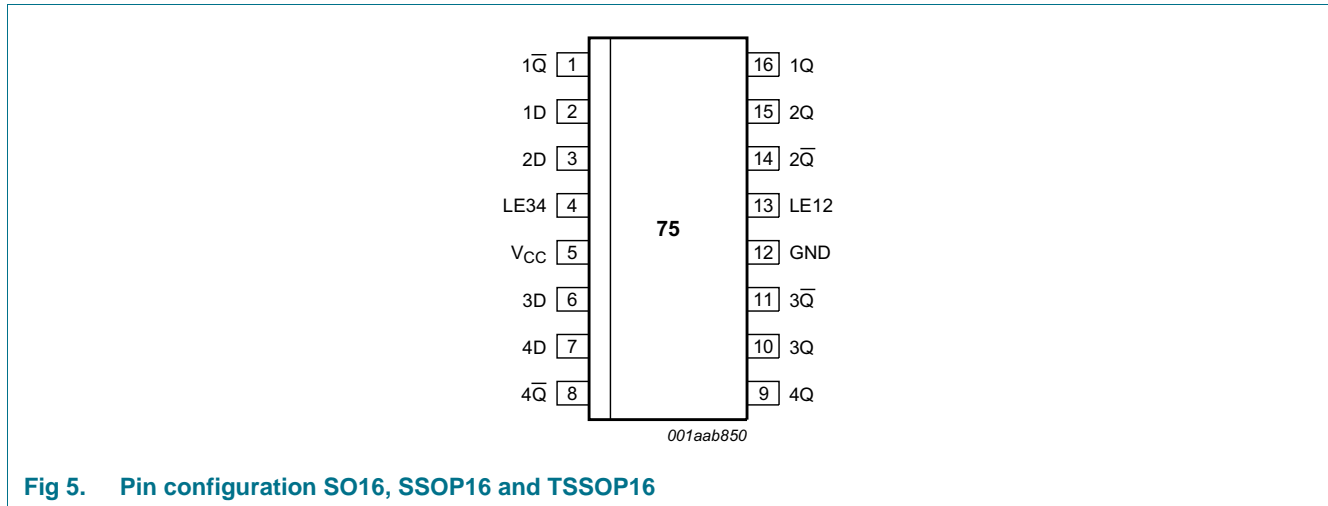

Fig 5. Pin configuration SO16, SSOP16 and TSSOP16

5.2 Pin description

Table 2. Pin description

Symbol	Pin	Description
1Q̄, 2Q̄, 3Q̄, 4Q̄	1, 14, 11, 8	complementary latch output
1D, 2D, 3D, 4D	2, 3, 6, 7	data input
LE34	4	latch enable input for latches 3 and 4 (active HIGH)
V _{CC}	5	positive supply voltage
GND	12	ground (0 V)
LE12	13	latch enable input for latches 1 and 2 (active HIGH)
1Q, 2Q, 3Q, 4Q	16, 15, 10, 9	latch output

6. Functional description

6.1 Function table

Table 3. Function table^[1]

Operating mode	Input		Output	
	LE _{nn}	nD	nQ	nQ̄
Data enabled	H	L	L	H
	H	H	H	L
Data latched	L	X	q	q̄

- [1] H = HIGH voltage level;
 L = LOW voltage level;
 q = lower case letters indicate the state of the referenced output one set-up time prior to the HIGH-to-LOW LE_{nn} transition;
 X = don't care.

7. Limiting values

Table 4. Limiting values

In accordance with the Absolute Maximum Rating System (IEC 60134). Voltages are referenced to GND (ground = 0 V).

Symbol	Parameter	Conditions	Min	Max	Unit
V_{CC}	supply voltage		-0.5	+7.0	V
I_{IK}	input clamping current	$V_I < -0.5\text{ V}$ or $V_I > V_{CC} + 0.5\text{ V}$ [1]	-	± 20	mA
I_{OK}	output clamping current	$V_O < -0.5\text{ V}$ or $V_O > V_{CC} + 0.5\text{ V}$ [1]	-	± 20	mA
I_O	output current	$V_O = -0.5\text{ V}$ to $V_{CC} + 0.5\text{ V}$	-	± 25	mA
I_{CC}	supply current		-	50	mA
I_{GND}	ground current		-50	-	mA
T_{stg}	storage temperature		-65	+150	°C
P_{tot}	total power dissipation	$T_{amb} = -40\text{ °C}$ to $+125\text{ °C}$			
		SO16 package [2]	-	500	mW
		(T)SSOP16 package [3]	-	500	mW

[1] The input and output voltage ratings may be exceeded if the input and output current ratings are observed.

[2] P_{tot} derates linearly with 8 mW/K above 70 °C.

[3] P_{tot} derates linearly with 5.5 mW/K above 60 °C.

8. Recommended operating conditions

Table 5. Recommended operating conditions

Symbol	Parameter	Conditions	Min	Typ	Max	Unit
V_{CC}	supply voltage		2.0	5.0	6.0	V
V_I	input voltage		0	-	V_{CC}	V
V_O	output voltage		0	-	V_{CC}	V
T_{amb}	ambient temperature		-40	-	+125	°C
$\Delta t/\Delta V$	input transition rise and fall rate	$V_{CC} = 2.0\text{ V}$	-	-	625	ns/V
		$V_{CC} = 4.5\text{ V}$	-	1.67	139	ns/V
		$V_{CC} = 6.0\text{ V}$	-	-	83	ns/V

9. Static characteristics

Table 6. Static characteristics

At recommended operating conditions; voltages are referenced to GND (ground = 0 V).

Symbol	Parameter	Conditions	Min	Typ	Max	Unit
$T_{amb} = 25\text{ °C}$						
V_{IH}	HIGH-level input voltage	$V_{CC} = 2.0\text{ V}$	1.5	1.2	-	V
		$V_{CC} = 4.5\text{ V}$	3.15	2.4	-	V
		$V_{CC} = 6.0\text{ V}$	4.2	3.2	-	V
V_{IL}	LOW-level input voltage	$V_{CC} = 2.0\text{ V}$	-	0.8	0.5	V
		$V_{CC} = 4.5\text{ V}$	-	2.1	1.35	V
		$V_{CC} = 6.0\text{ V}$	-	2.8	1.8	V

Table 6. Static characteristics ...continued

At recommended operating conditions; voltages are referenced to GND (ground = 0 V).

Symbol	Parameter	Conditions	Min	Typ	Max	Unit
V _{OH}	HIGH-level output voltage	V _I = V _{IH} or V _{IL}				
		I _O = -20 μA; V _{CC} = 2.0 V	1.9	2.0	-	V
		I _O = -20 μA; V _{CC} = 4.5 V	4.4	4.5	-	V
		I _O = -20 μA; V _{CC} = 6.0 V	5.9	6.0	-	V
		I _O = -4 mA; V _{CC} = 4.5 V	3.98	4.32	-	V
		I _O = -5.2 mA; V _{CC} = 6.0 V	5.48	5.81	-	V
V _{OL}	LOW-level output voltage	V _I = V _{IH} or V _{IL}				
		I _O = 20 μA; V _{CC} = 2.0 V	-	0	0.1	V
		I _O = 20 μA; V _{CC} = 4.5 V	-	0	0.1	V
		I _O = 20 μA; V _{CC} = 6.0 V	-	0	0.1	V
		I _O = 4 mA; V _{CC} = 4.5 V	-	0.15	0.26	V
		I _O = 5.2 mA; V _{CC} = 6.0 V	-	0.16	0.26	V
I _I	input leakage current	V _I = V _{CC} or GND; V _{CC} = 6.0 V	-	-	±0.1	μA
I _{CC}	supply current	V _I = V _{CC} or GND; I _O = 0 A; V _{CC} = 6.0 V	-	-	8.0	μA
C _I	input capacitance		-	3.5	-	pF
T_{amb} = -40 °C to +85 °C						
V _{IH}	HIGH-level input voltage	V _{CC} = 2.0 V	1.5	-	-	V
		V _{CC} = 4.5 V	3.15	-	-	V
		V _{CC} = 6.0 V	4.2	-	-	V
V _{IL}	LOW-level input voltage	V _{CC} = 2.0 V	-	-	0.5	V
		V _{CC} = 4.5 V	-	-	1.35	V
		V _{CC} = 6.0 V	-	-	1.8	V
V _{OH}	HIGH-level output voltage	V _I = V _{IH} or V _{IL}				
		I _O = -20 μA; V _{CC} = 2.0 V	1.9	-	-	V
		I _O = -20 μA; V _{CC} = 4.5 V	4.4	-	-	V
		I _O = -20 μA; V _{CC} = 6.0 V	5.9	-	-	V
		I _O = -4 mA; V _{CC} = 4.5 V	3.84	-	-	V
		I _O = -5.2 mA; V _{CC} = 6.0 V	5.34	-	-	V
V _{OL}	LOW-level output voltage	V _I = V _{IH} or V _{IL}				
		I _O = 20 μA; V _{CC} = 2.0 V	-	-	0.1	V
		I _O = 20 μA; V _{CC} = 4.5 V	-	-	0.1	V
		I _O = 20 μA; V _{CC} = 6.0 V	-	-	0.1	V
		I _O = 4 mA; V _{CC} = 4.5 V	-	-	0.33	V
		I _O = 5.2 mA; V _{CC} = 6.0 V	-	-	0.33	V
I _I	input leakage current	V _I = V _{CC} or GND; V _{CC} = 6.0 V	-	-	±1.0	μA
I _{CC}	supply current	V _I = V _{CC} or GND; I _O = 0 A; V _{CC} = 6.0 V	-	-	80	μA

Table 6. Static characteristics ...continued

At recommended operating conditions; voltages are referenced to GND (ground = 0 V).

Symbol	Parameter	Conditions	Min	Typ	Max	Unit
T_{amb} = -40 °C to +125 °C						
V _{IH}	HIGH-level input voltage	V _{CC} = 2.0 V	1.5	-	-	V
		V _{CC} = 4.5 V	3.15	-	-	V
		V _{CC} = 6.0 V	4.2	-	-	V
V _{IL}	LOW-level input voltage	V _{CC} = 2.0 V	-	-	0.5	V
		V _{CC} = 4.5 V	-	-	1.35	V
		V _{CC} = 6.0 V	-	-	1.8	V
V _{OH}	HIGH-level output voltage	V _I = V _{IH} or V _{IL}		-		
		I _O = -20 μA; V _{CC} = 2.0 V	1.9	-	-	V
		I _O = -20 μA; V _{CC} = 4.5 V	4.4	-	-	V
		I _O = -20 μA; V _{CC} = 6.0 V	5.9	-	-	V
		I _O = -4 mA; V _{CC} = 4.5 V	3.7	-	-	V
V _{OL}	LOW-level output voltage	V _I = V _{IH} or V _{IL}		-		
		I _O = 20 μA; V _{CC} = 2.0 V	-	-	0.1	V
		I _O = 20 μA; V _{CC} = 4.5 V	-	-	0.1	V
		I _O = 20 μA; V _{CC} = 6.0 V	-	-	0.1	V
		I _O = 4 mA; V _{CC} = 4.5 V	-	-	0.4	V
I _I	input leakage current	I _O = -5.2 mA; V _{CC} = 6.0 V	5.2	-	-	V
		V _I = V _{CC} or GND; V _{CC} = 6.0 V	-	-	±1.0	μA
I _{CC}	supply current	V _I = V _{CC} or GND; I _O = 0 A; V _{CC} = 6.0 V	-	-	160	μA

10. Dynamic characteristics

Table 7. Dynamic characteristics

$GND = 0\text{ V}$; $t_r = t_f = 6\text{ ns}$; $C_L = 50\text{ pF}$; unless otherwise specified, see [Figure 10](#).

Symbol	Parameter	Conditions	Min	Typ	Max	Unit	
$T_{\text{amb}} = 25\text{ °C}$							
$t_{\text{PHL}}, t_{\text{PLH}}$	propagation delay nD to nQ	see Figure 6					
		$V_{\text{CC}} = 2.0\text{ V}$	-	33	110	ns	
		$V_{\text{CC}} = 4.5\text{ V}$	-	12	22	ns	
		$V_{\text{CC}} = 6.0\text{ V}$	-	10	19	ns	
		$V_{\text{CC}} = 5.0\text{ V}$; $C_L = 15\text{ pF}$	-	11	-	ns	
	propagation delay nD to nQ̄	see Figure 7					
		$V_{\text{CC}} = 2.0\text{ V}$	-	39	120	ns	
		$V_{\text{CC}} = 4.5\text{ V}$	-	14	24	ns	
		$V_{\text{CC}} = 6.0\text{ V}$	-	11	20	ns	
		$V_{\text{CC}} = 5.0\text{ V}$; $C_L = 15\text{ pF}$	-	11	-	ns	
	propagation delay LEnn to nQ	see Figure 9					
		$V_{\text{CC}} = 2.0\text{ V}$	-	33	120	ns	
		$V_{\text{CC}} = 4.5\text{ V}$	-	12	24	ns	
		$V_{\text{CC}} = 6.0\text{ V}$	-	10	20	ns	
		$V_{\text{CC}} = 5.0\text{ V}$; $C_L = 15\text{ pF}$	-	11	-	ns	
	propagation delay LEnn to nQ̄	see Figure 9					
$V_{\text{CC}} = 2.0\text{ V}$		-	39	125	ns		
$V_{\text{CC}} = 4.5\text{ V}$		-	14	25	ns		
$V_{\text{CC}} = 6.0\text{ V}$		-	11	21	ns		
	$V_{\text{CC}} = 5.0\text{ V}$; $C_L = 15\text{ pF}$	-	11	-	ns		
$t_{\text{THL}}, t_{\text{TLH}}$	output transition time	see Figure 6 and 7					
		$V_{\text{CC}} = 2.0\text{ V}$	-	19	75	ns	
		$V_{\text{CC}} = 4.5\text{ V}$	-	7	15	ns	
		$V_{\text{CC}} = 6.0\text{ V}$	-	6	13	ns	
t_w	enable pulse width HIGH	see Figure 9					
		$V_{\text{CC}} = 2.0\text{ V}$	80	17	-	ns	
		$V_{\text{CC}} = 4.5\text{ V}$	16	6	-	ns	
		$V_{\text{CC}} = 6.0\text{ V}$	14	5	-	ns	
t_{su}	set-up time nD to LEnn	see Figure 8					
		$V_{\text{CC}} = 2.0\text{ V}$	60	14	-	ns	
		$V_{\text{CC}} = 4.5\text{ V}$	12	5	-	ns	
		$V_{\text{CC}} = 6.0\text{ V}$	10	4	-	ns	
t_h	hold time nD to LEnn	see Figure 8					
		$V_{\text{CC}} = 2.0\text{ V}$	3	-8	-	ns	
		$V_{\text{CC}} = 4.5\text{ V}$	3	-3	-	ns	
		$V_{\text{CC}} = 6.0\text{ V}$	3	-2	-	ns	

Table 7. Dynamic characteristics ...continued

$GND = 0\text{ V}$; $t_r = t_f = 6\text{ ns}$; $C_L = 50\text{ pF}$; unless otherwise specified, see [Figure 10](#).

Symbol	Parameter	Conditions	Min	Typ	Max	Unit	
C_{PD}	power dissipation capacitance per latch	$V_I = GND$ to V_{CC} [1]	-	42	-	pF	
$T_{amb} = -40\text{ °C}$ to $+85\text{ °C}$							
t_{PHL} , t_{PLH}	propagation delay nD to nQ	see Figure 6					
		$V_{CC} = 2.0\text{ V}$	-	-	140	ns	
		$V_{CC} = 4.5\text{ V}$	-	-	28	ns	
	propagation delay nD to nQ	see Figure 7					
		$V_{CC} = 2.0\text{ V}$	-	-	150	ns	
		$V_{CC} = 4.5\text{ V}$	-	-	30	ns	
	propagation delay LEnn to nQ	see Figure 9					
		$V_{CC} = 2.0\text{ V}$	-	-	150	ns	
		$V_{CC} = 4.5\text{ V}$	-	-	30	ns	
	propagation delay LEnn to nQ	see Figure 9					
		$V_{CC} = 2.0\text{ V}$	-	-	155	ns	
		$V_{CC} = 4.5\text{ V}$	-	-	31	ns	
t_{THL} , t_{TLH}	output transition time	see Figure 6 and 7					
		$V_{CC} = 2.0\text{ V}$	-	-	95	ns	
		$V_{CC} = 4.5\text{ V}$	-	-	19	ns	
		$V_{CC} = 6.0\text{ V}$	-	-	16	ns	
t_W	enable pulse width HIGH	see Figure 9					
		$V_{CC} = 2.0\text{ V}$	100	-	-	ns	
		$V_{CC} = 4.5\text{ V}$	20	-	-	ns	
		$V_{CC} = 6.0\text{ V}$	17	-	-	ns	
t_{su}	set-up time nD to LEnn	see Figure 8					
		$V_{CC} = 2.0\text{ V}$	75	-	-	ns	
		$V_{CC} = 4.5\text{ V}$	15	-	-	ns	
		$V_{CC} = 6.0\text{ V}$	13	-	-	ns	
t_h	hold time nD to LEnn	see Figure 8					
		$V_{CC} = 2.0\text{ V}$	3	-	-	ns	
		$V_{CC} = 4.5\text{ V}$	3	-	-	ns	
		$V_{CC} = 6.0\text{ V}$	3	-	-	ns	

Table 7. Dynamic characteristics ...continued

$GND = 0\text{ V}$; $t_r = t_f = 6\text{ ns}$; $C_L = 50\text{ pF}$; unless otherwise specified, see [Figure 10](#).

Symbol	Parameter	Conditions	Min	Typ	Max	Unit	
$T_{\text{amb}} = -40\text{ °C to }+125\text{ °C}$							
$t_{\text{PHL}}, t_{\text{PLH}}$	propagation delay nD to nQ	see Figure 6					
		$V_{\text{CC}} = 2.0\text{ V}$	-	-	165	ns	
		$V_{\text{CC}} = 4.5\text{ V}$	-	-	33	ns	
		$V_{\text{CC}} = 6.0\text{ V}$	-	-	28	ns	
	propagation delay nD to $\overline{\text{nQ}}$	see Figure 7					
		$V_{\text{CC}} = 2.0\text{ V}$	-	-	180	ns	
		$V_{\text{CC}} = 4.5\text{ V}$	-	-	36	ns	
		$V_{\text{CC}} = 6.0\text{ V}$	-	-	31	ns	
	propagation delay LEnn to nQ	see Figure 9					
		$V_{\text{CC}} = 2.0\text{ V}$	-	-	180	ns	
		$V_{\text{CC}} = 4.5\text{ V}$	-	-	36	ns	
		$V_{\text{CC}} = 6.0\text{ V}$	-	-	31	ns	
propagation delay LEnn to $\overline{\text{nQ}}$	see Figure 9						
	$V_{\text{CC}} = 2.0\text{ V}$	-	-	190	ns		
	$V_{\text{CC}} = 4.5\text{ V}$	-	-	38	ns		
	$V_{\text{CC}} = 6.0\text{ V}$	-	-	32	ns		
$t_{\text{THL}}, t_{\text{TLH}}$	output transition time	see Figure 6 and 7					
		$V_{\text{CC}} = 2.0\text{ V}$	-	-	110	ns	
		$V_{\text{CC}} = 4.5\text{ V}$	-	-	22	ns	
	$V_{\text{CC}} = 6.0\text{ V}$	-	-	19	ns		
t_{W}	enable pulse width HIGH	see Figure 9					
		$V_{\text{CC}} = 2.0\text{ V}$	120	-	-	ns	
		$V_{\text{CC}} = 4.5\text{ V}$	24	-	-	ns	
	$V_{\text{CC}} = 6.0\text{ V}$	20	-	-	ns		
t_{su}	set-up time nD to LEnn	see Figure 8					
		$V_{\text{CC}} = 2.0\text{ V}$	90	-	-	ns	
		$V_{\text{CC}} = 4.5\text{ V}$	18	-	-	ns	
	$V_{\text{CC}} = 6.0\text{ V}$	15	-	-	ns		
t_{h}	hold time nD to LEnn	see Figure 8					
		$V_{\text{CC}} = 2.0\text{ V}$	3	-	-	ns	
		$V_{\text{CC}} = 4.5\text{ V}$	3	-	-	ns	
	$V_{\text{CC}} = 6.0\text{ V}$	3	-	-	ns		

[1] C_{PD} is used to determine the dynamic power dissipation (P_{D} in μW).

$P_{\text{D}} = C_{\text{PD}} \times V_{\text{CC}}^2 \times f_i \times N + \sum(C_L \times V_{\text{CC}}^2 \times f_o)$ where:

f_i = input frequency in MHz;

f_o = output frequency in MHz;

C_L = output load capacitance in pF;

V_{CC} = supply voltage in V;

N = number of inputs switching;

$\sum(C_L \times V_{\text{CC}}^2 \times f_o)$ = sum of outputs.

11. Waveforms

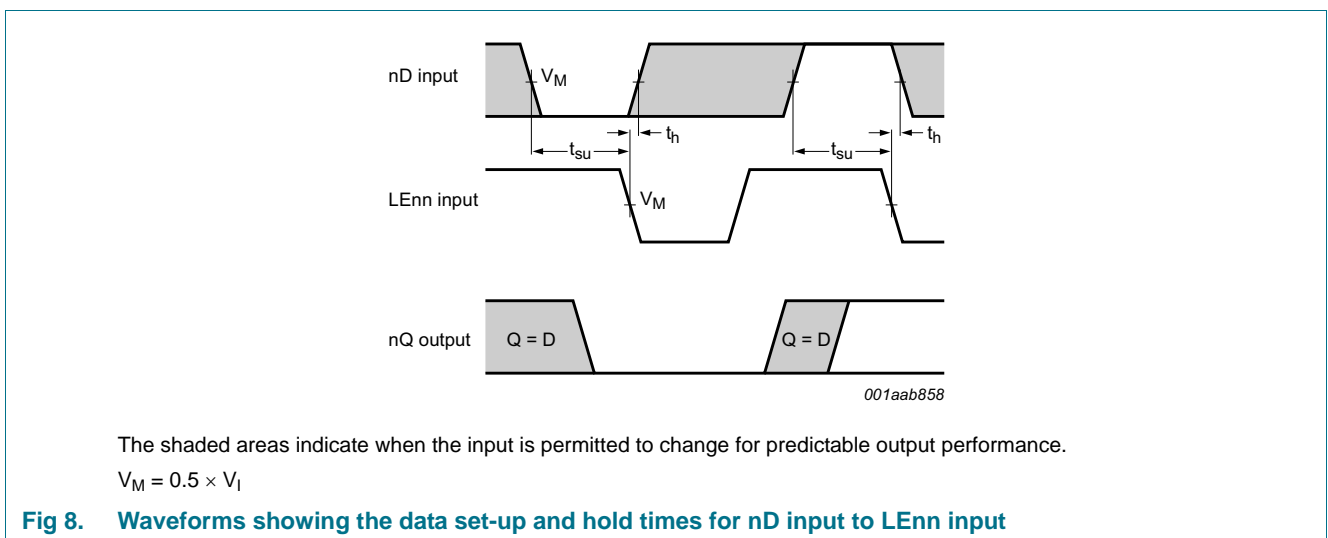
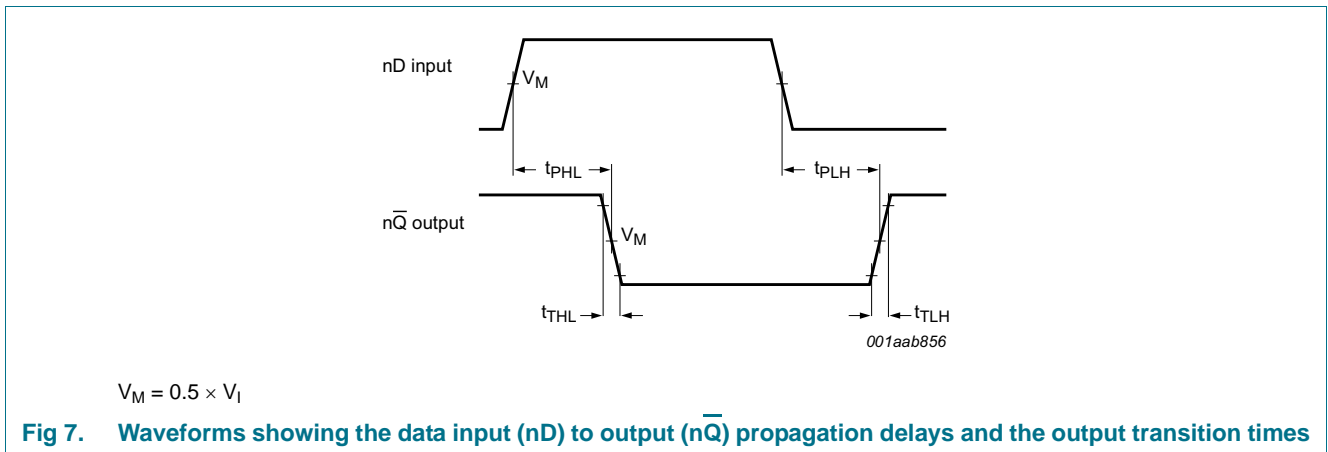
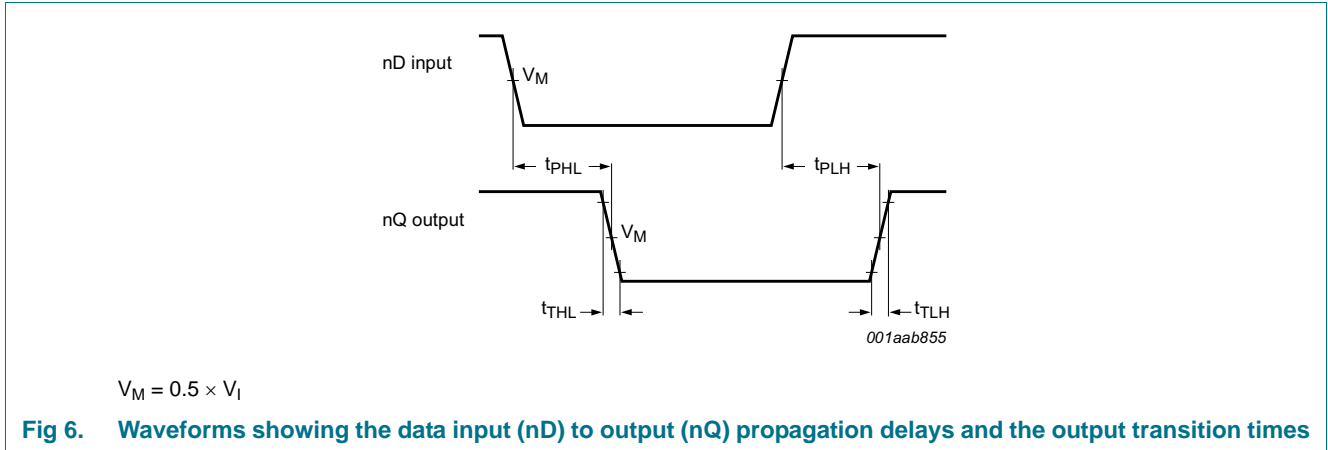

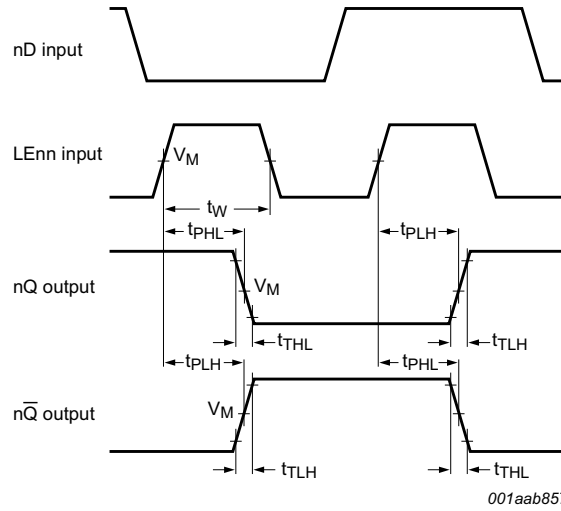

$V_M = 0.5 \times V_I$

Fig 9. Waveforms showing the latch enable input (LEnn) pulse width, the latch enable input to outputs (nQ, nQ̄) propagation delays and the output transition times

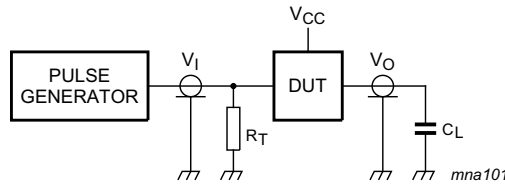

Test data is given in [Table 8](#)

Definitions for test circuit:

R_T = Termination resistance should be equal to output impedance Z_o of the pulse generator

C_L = Load capacitance including jig and probe capacitance

Fig 10. Test circuit for measuring switching times

Table 8. Test data

Supply	Input	Load
V_{CC}	V_I	C_L
2.0 V	V_{CC}	50 pF
4.5 V	V_{CC}	50 pF
6.0 V	V_{CC}	50 pF
5.0 V	V_{CC}	15 pF

12. Package outline

SO16: plastic small outline package; 16 leads; body width 3.9 mm

SOT109-1



Fig 11. Package outline SOT109-1 (SO16)

SSOP16: plastic shrink small outline package; 16 leads; body width 5.3 mm

SOT338-1

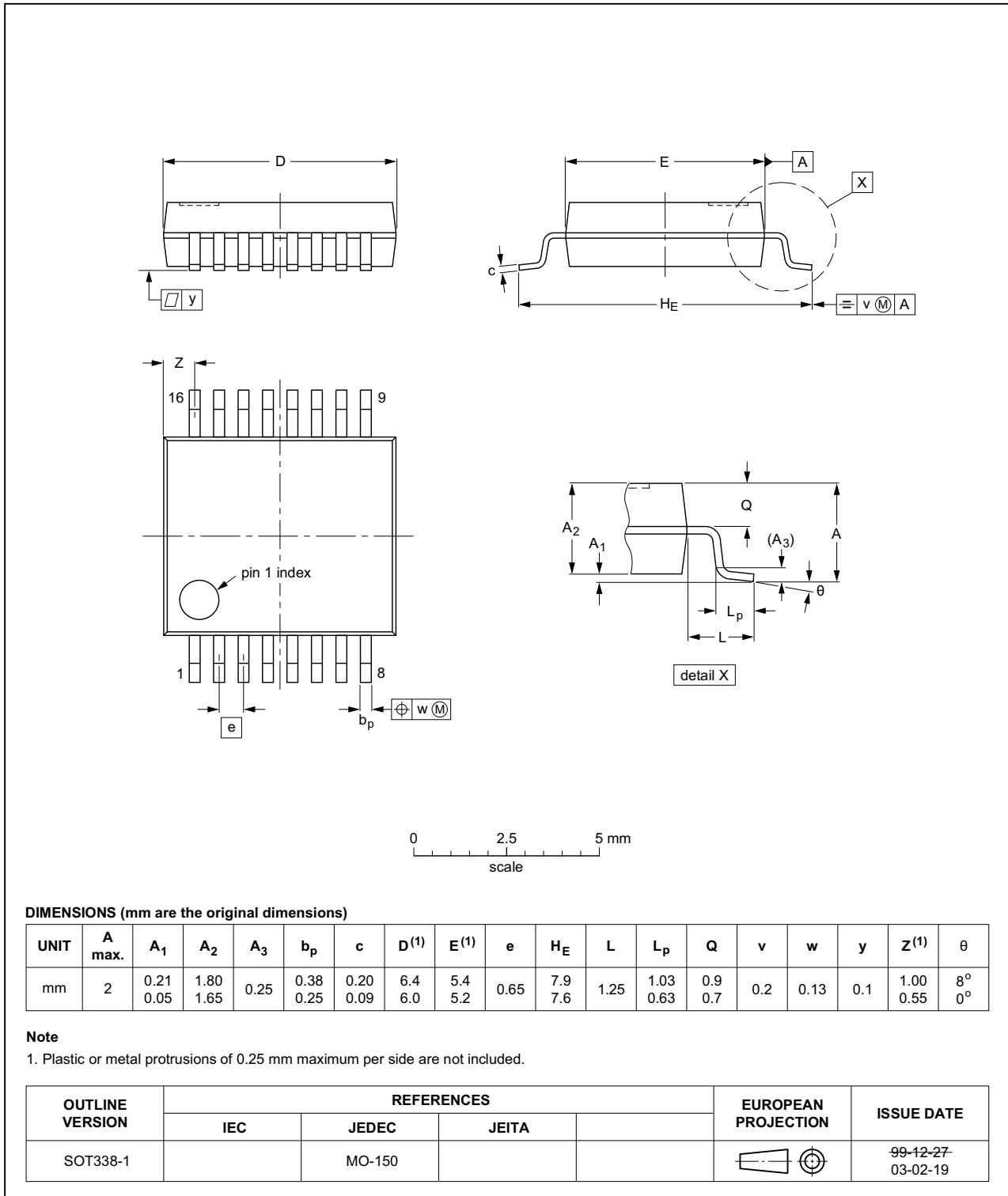

Fig 12. Package outline SOT338-1 (SSOP16)

TSSOP16: plastic thin shrink small outline package; 16 leads; body width 4.4 mm

SOT403-1



Fig 13. Package outline SOT403-1 (TSSOP16)

13. Abbreviations

Table 9. Abbreviations

Acronym	Abbreviation
CMOS	Complementary Metal Oxide Semiconductor
DUT	Device Under Test
ESD	ElectroStatic Discharge
HBM	Human Body Model
LSTTL	Low-power Schottky Transistor-Transistor Logic
MM	Machine Model

14. Revision history

Table 10. Revision history

Document ID	Release date	Data sheet status	Change notice	Supersedes
74HC75 v.4	20160224	Product data sheet	-	74HC75 v.3
Modifications:	<ul style="list-style-type: none"> Type number 74HC75N (SOT38-4) removed. 			
74HC75 v.3	20041112	Product data sheet	-	74HC_HCT75_CNV v.2
Modifications:	<ul style="list-style-type: none"> The format of this data sheet has been redesigned to comply with the current presentation and information standard of Philips Semiconductors. Removed type number 74HCT75. Inserted family specification. 			
74HC_HCT75_CNV v.2	19970918	Product specification	-	74HC_HCT75 v.1
74HC_HCT75 v.1	19901201	Product specification	-	-

15. Legal information

15.1 Data sheet status

Document status ^{[1][2]}	Product status ^[3]	Definition
Objective [short] data sheet	Development	This document contains data from the objective specification for product development.
Preliminary [short] data sheet	Qualification	This document contains data from the preliminary specification.
Product [short] data sheet	Production	This document contains the product specification.

[1] Please consult the most recently issued document before initiating or completing a design.

[2] The term 'short data sheet' is explained in section "Definitions".

[3] The product status of device(s) described in this document may have changed since this document was published and may differ in case of multiple devices. The latest product status information is available on the Internet at URL <http://www.nexperia.com>.

15.2 Definitions

Draft — The document is a draft version only. The content is still under internal review and subject to formal approval, which may result in modifications or additions. Nexperia does not give any representations or warranties as to the accuracy or completeness of information included herein and shall have no liability for the consequences of use of such information.

Short data sheet — A short data sheet is an extract from a full data sheet with the same product type number(s) and title. A short data sheet is intended for quick reference only and should not be relied upon to contain detailed and full information. For detailed and full information see the relevant full data sheet, which is available on request via the local Nexperia sales office. In case of any inconsistency or conflict with the short data sheet, the full data sheet shall prevail.

Product specification — The information and data provided in a Product data sheet shall define the specification of the product as agreed between Nexperia and its customer, unless Nexperia and customer have explicitly agreed otherwise in writing. In no event however, shall an agreement be valid in which the Nexperia product is deemed to offer functions and qualities beyond those described in the Product data sheet.

15.3 Disclaimers

Limited warranty and liability — Information in this document is believed to be accurate and reliable. However, Nexperia does not give any representations or warranties, expressed or implied, as to the accuracy or completeness of such information and shall have no liability for the consequences of use of such information. Nexperia takes no responsibility for the content in this document if provided by an information source outside of Nexperia.

In no event shall Nexperia be liable for any indirect, incidental, punitive, special or consequential damages (including - without limitation - lost profits, lost savings, business interruption, costs related to the removal or replacement of any products or rework charges) whether or not such damages are based on tort (including negligence), warranty, breach of contract or any other legal theory.

Notwithstanding any damages that customer might incur for any reason whatsoever, Nexperia's aggregate and cumulative liability towards customer for the products described herein shall be limited in accordance with the *Terms and conditions of commercial sale* of Nexperia.

Right to make changes — Nexperia reserves the right to make changes to information published in this document, including without limitation specifications and product descriptions, at any time and without notice. This document supersedes and replaces all information supplied prior to the publication hereof.

Suitability for use — Nexperia products are not designed, authorized or warranted to be suitable for use in life support, life-critical or safety-critical systems or equipment, nor in applications where failure or malfunction of a Nexperia product can reasonably be expected to result in personal injury, death or severe property or environmental damage. Nexperia and its suppliers accept no liability for inclusion and/or use of Nexperia products in such equipment or applications and therefore such inclusion and/or use is at the customer's own risk.

Applications — Applications that are described herein for any of these products are for illustrative purposes only. Nexperia makes no representation or warranty that such applications will be suitable for the specified use without further testing or modification.

Customers are responsible for the design and operation of their applications and products using Nexperia products, and Nexperia accepts no liability for any assistance with applications or customer product design. It is customer's sole responsibility to determine whether the Nexperia product is suitable and fit for the customer's applications and products planned, as well as for the planned application and use of customer's third party customer(s). Customers should provide appropriate design and operating safeguards to minimize the risks associated with their applications and products.

Nexperia does not accept any liability related to any default, damage, costs or problem which is based on any weakness or default in the customer's applications or products, or the application or use by customer's third party customer(s). Customer is responsible for doing all necessary testing for the customer's applications and products using Nexperia products in order to avoid a default of the applications and the products or of the application or use by customer's third party customer(s). Nexperia does not accept any liability in this respect.

Limiting values — Stress above one or more limiting values (as defined in the Absolute Maximum Ratings System of IEC 60134) will cause permanent damage to the device. Limiting values are stress ratings only and (proper) operation of the device at these or any other conditions above those given in the Recommended operating conditions section (if present) or the Characteristics sections of this document is not warranted. Constant or repeated exposure to limiting values will permanently and irreversibly affect the quality and reliability of the device.

Terms and conditions of commercial sale — Nexperia products are sold subject to the general terms and conditions of commercial sale, as published at <http://www.nexperia.com/profile/terms>, unless otherwise agreed in a valid written individual agreement. In case an individual agreement is concluded only the terms and conditions of the respective agreement shall apply. Nexperia hereby expressly objects to applying the customer's general terms and conditions with regard to the purchase of Nexperia products by customer.

No offer to sell or license — Nothing in this document may be interpreted or construed as an offer to sell products that is open for acceptance or the grant, conveyance or implication of any license under any copyrights, patents or other industrial or intellectual property rights.

Export control — This document as well as the item(s) described herein may be subject to export control regulations. Export might require a prior authorization from competent authorities.

Non-automotive qualified products — Unless this data sheet expressly states that this specific Nexperia product is automotive qualified, the product is not suitable for automotive use. It is neither qualified nor tested in accordance with automotive testing or application requirements. Nexperia accepts no liability for inclusion and/or use of non-automotive qualified products in automotive equipment or applications.

In the event that customer uses the product for design-in and use in automotive applications to automotive specifications and standards, customer (a) shall use the product without Nexperia's warranty of the product for such automotive applications, use and specifications, and (b) whenever customer uses the product for automotive applications beyond

Nexperia's specifications such use shall be solely at customer's own risk, and (c) customer fully indemnifies Nexperia for any liability, damages or failed product claims resulting from customer design and use of the product for automotive applications beyond Nexperia's standard warranty and Nexperia's product specifications.

Translations — A non-English (translated) version of a document is for reference only. The English version shall prevail in case of any discrepancy between the translated and English versions.

15.4 Trademarks

Notice: All referenced brands, product names, service names and trademarks are the property of their respective owners.

16. Contact information

For more information, please visit: <http://www.nexperia.com>

For sales office addresses, please send an email to: salesaddresses@nexperia.com

17. Contents

1	General description	1
2	Features and benefits	1
3	Ordering information	1
4	Functional diagram	2
5	Pinning information	4
5.1	Pinning	4
5.2	Pin description	4
6	Functional description	4
6.1	Function table	4
7	Limiting values	5
8	Recommended operating conditions	5
9	Static characteristics	5
10	Dynamic characteristics	8
11	Waveforms	11
12	Package outline	13
13	Abbreviations	16
14	Revision history	16
15	Legal information	17
15.1	Data sheet status	17
15.2	Definitions	17
15.3	Disclaimers	17
15.4	Trademarks	18
16	Contact information	18
17	Contents	19

Компания «Life Electronics» занимается поставками электронных компонентов импортного и отечественного производства от производителей и со складов крупных дистрибьюторов Европы, Америки и Азии.

С конца 2013 года компания активно расширяет линейку поставок компонентов по направлению коаксиальный кабель, кварцевые генераторы и конденсаторы (керамические, пленочные, электролитические), за счёт заключения дистрибьюторских договоров

Мы предлагаем:

- Конкурентоспособные цены и скидки постоянным клиентам.
- Специальные условия для постоянных клиентов.
- Подбор аналогов.
- Поставку компонентов в любых объемах, удовлетворяющих вашим потребностям.
- Приемлемые сроки поставки, возможна ускоренная поставка.
- Доставку товара в любую точку России и стран СНГ.
- Комплексную поставку.
- Работу по проектам и поставку образцов.
- Формирование склада под заказчика.
- Сертификаты соответствия на поставляемую продукцию (по желанию клиента).
- Тестирование поставляемой продукции.
- Поставку компонентов, требующих военную и космическую приемку.
- Входной контроль качества.
- Наличие сертификата ISO.

В составе нашей компании организован Конструкторский отдел, призванный помогать разработчикам, и инженерам.

Конструкторский отдел помогает осуществить:

- Регистрацию проекта у производителя компонентов.
- Техническую поддержку проекта.
- Защиту от снятия компонента с производства.
- Оценку стоимости проекта по компонентам.
- Изготовление тестовой платы монтаж и пусконаладочные работы.



Тел: +7 (812) 336 43 04 (многоканальный)

Email: org@lifeelectronics.ru