

## General purpose input/output rail-to-rail low-power operational amplifiers

Datasheet - production data



### Features

- Operating range  $V_{CC} = 2.5\text{ V to }6\text{ V}$
- Rail-to-rail input and output
- Extended  $V_{icm}$  ( $V_{DD} - 0.2\text{ V to }V_{CC} + 0.2\text{ V}$ )
- Capable of driving a  $32\ \Omega$  load resistor
- High stability:  $500\text{ pF}$
- Operating temperature range:  $-40\text{ to }125\text{ }^\circ\text{C}$

### Related products

- See LMV321L, LMV358L, LMV324L for newer technology version
- See TSV851, TSV852, TSV854 for enhanced performances

### Applications

- Battery powered applications
- Audio driver (headphone driver)
- Sensor signal conditioning
- Laptop/notebook computers

### Description

The TSV358, TSV358A, TSV324, and TSV324A (dual and quad) devices are low voltage versions of the LM358 and LM324 commodity operational amplifiers. The TSV321 and TSV321A are the single version. All devices operate with voltages as low as  $2.5\text{ V}$  and feature both I/O rail-to-rail.

The common mode input voltage extends  $200\text{ mV}$  beyond the supply voltages at  $25\text{ }^\circ\text{C}$  while the output voltage swing is within  $100\text{ mV}$  of each rail with a  $600\ \Omega$  load resistor. At  $V_{CC} = 3\text{ V}$ , these devices offer  $1.3\text{ MHz}$  of gain bandwidth product and provide high output current capability with a typical value of  $80\text{ mA}$ .

These features make the TSV3xx and TSV3xxA family ideal for active filters, general purpose low voltage applications, and general purpose portable devices.

## Contents

<b>1</b>	<b>Absolute maximum ratings and operating conditions .....</b>	<b>3</b>
<b>2</b>	<b>Electrical characteristics .....</b>	<b>5</b>
<b>3</b>	<b>Package information .....</b>	<b>11</b>
3.1	SOT23-5 package information .....	12
3.2	SO8 package information.....	13
3.3	MiniSO8 package information .....	14
3.4	TSSOP8 package information.....	15
3.5	SO14 package information.....	16
3.6	TSSOP14 package information.....	17
<b>4</b>	<b>Ordering information.....</b>	<b>18</b>
<b>5</b>	<b>Revision history .....</b>	<b>19</b>

# 1 Absolute maximum ratings and operating conditions

Table 1: Absolute maximum ratings

Symbol	Parameter	Value	Unit	
$V_{CC}$	Supply voltage <sup>(1)</sup>	7	V	
$V_{id}$	Differential input voltage <sup>(2)</sup>	±1		
$V_{in}$	Input voltage	$V_{DD} - 0.3$ to $V_{CC} + 0.3$		
$T_{stg}$	Storage temperature	-65 to +150	°C	
$T_j$	Maximum junction temperature	150		
$R_{thja}$	Thermal resistance junction-to-ambient <sup>(3)</sup>	SOT23-5	250	°C/W
		SO8	125	
		MiniSO8	190	
		TSSOP8	120	
		SO14	105	
		TSSOP14	100	
$R_{thjc}$	Thermal resistance junction-to-case <sup>(3)</sup>	SOT23-5	81	
		SO8	40	
		MiniSO8	39	
		TSSOP8	37	
		SO14	31	
		TSSOP14	32	
ESD	HBM: human body model <sup>(4)</sup>	2	kV	
	MM: machine model <sup>(5)</sup>	200	V	
	CDM: charged device model <sup>(6)</sup>	1.5	kV	
	Latch-up immunity	200	mA	
	Lead temperature (soldering, 10 s)	250	°C	
	Output short-circuit duration	See <sup>(7)</sup>		

**Notes:**

- <sup>(1)</sup>All voltage values, except the differential voltage are with respect to the network terminal.
- <sup>(2)</sup>The differential voltage is the non-inverting input terminal with respect to the inverting input terminal. If  $V_{id} > \pm 1$  V, the maximum input current must not exceed  $\pm 1$  mA. When  $V_{id} > \pm 1$  V, an input series resistor must be added to limit input current.
- <sup>(3)</sup>Short-circuits can cause excessive heating and destructive dissipation.  $R_{th}$  are typical values.
- <sup>(4)</sup>Human body model: 100 pF discharged through a 1.5 kΩ resistor between two pins of the device, done for all couples of pin combinations with other pins floating.
- <sup>(5)</sup>Machine model: a 200 pF capacitor is charged to the specified voltage, then discharged directly between two pins of the device with no external series resistor (internal resistor < 5 Ω), done for all couples of pin combinations with other pins floating.
- <sup>(6)</sup>Charged device model: all pins plus package are charged together to the specified voltage and then discharged directly to ground.
- <sup>(7)</sup>Short-circuits from the output to  $V_{CC}$  can cause excessive heating. The maximum output current is approximately 80 mA, independent of the magnitude of  $V_{CC}$ . Destructive dissipation can result from simultaneous short-circuits on all amplifiers.

Table 2: Operating conditions

Symbol	Parameter		Value	Unit
$V_{CC}$	Supply voltage		2.5 to 6	V
$V_{icm}$	Common mode input voltage range	$T_{amb} = 25\text{ }^{\circ}\text{C}, 2.5 \leq V_{CC} \leq 6\text{ V}$	$V_{DD} - 0.2$ to $V_{CC} + 0.2$	V
		$T_{min} < T_{amb} < T_{max}, 2.5 \leq V_{CC} \leq 5.5\text{ V}$	$V_{DD}$ to $V_{CC}$	
$T_{oper}$	Operating free air temperature range		-40 to + 125	$^{\circ}\text{C}$

## 2 Electrical characteristics

Table 3: Electrical characteristics at VCC = +3 V, VDD = 0 V, RL, CL connected to VCC/2, and Tamb = 25 °C (unless otherwise specified)

Symbol	Parameter	Test conditions	Min.	Typ.	Max.	Unit
V <sub>io</sub>	Input offset voltage	V <sub>icm</sub> = V <sub>out</sub> = V <sub>CC</sub> /2				mV
		TSV321/358/324		0.2	3	
		T <sub>min</sub> ≤ T <sub>amb</sub> ≤ T <sub>max</sub>			6	
		TSV321A/358A/324A		0.1	1	
		T <sub>min</sub> ≤ T <sub>amb</sub> ≤ T <sub>max</sub>			3	
ΔV <sub>io</sub> /ΔT	Input offset voltage drift			2		μV/°C
I <sub>io</sub>	Input offset current	V <sub>icm</sub> = V <sub>out</sub> = V <sub>CC</sub> /2 <sup>(1)</sup>		3	30	nA
		T <sub>min</sub> ≤ T <sub>amb</sub> ≤ T <sub>max</sub>			60	
I <sub>ib</sub>	Input bias current	V <sub>icm</sub> = V <sub>out</sub> = V <sub>CC</sub> /2 <sup>(1)</sup>		40	125	
		T <sub>min</sub> ≤ T <sub>amb</sub> ≤ T <sub>max</sub>			150	
CMR	Common mode rejection ratio 20 log (ΔV <sub>ic</sub> /ΔV <sub>io</sub> )	0 ≤ V <sub>icm</sub> ≤ V <sub>CC</sub> , V <sub>out</sub> = V <sub>CC</sub> /2	60	80		dB
A <sub>vd</sub>	Large signal voltage gain	V <sub>out</sub> = 0.5 V to 2.5 V, R <sub>L</sub> = 2 kΩ	80	92		
		V <sub>out</sub> = 0.5 V to 2.5 V, R <sub>L</sub> = 600 Ω	74	95		
V <sub>OH</sub>	High level output voltage, V <sub>OH</sub> = V <sub>out</sub>	V <sub>id</sub> = 100 mV, R <sub>L</sub> = 2 kΩ	2.82	2.95		V
		V <sub>id</sub> = 100 mV, R <sub>L</sub> = 600 Ω	2.80	2.95		
		V <sub>id</sub> = 100 mV, T <sub>min</sub> ≤ T <sub>amb</sub> ≤ T <sub>max</sub> , R <sub>L</sub> = 2 kΩ	2.82			
		V <sub>id</sub> = 100 mV, T <sub>min</sub> ≤ T <sub>amb</sub> ≤ T <sub>max</sub> , R <sub>L</sub> = 600 Ω	2.80			
V <sub>OL</sub>	Low level output voltage	V <sub>id</sub> = -100 mV, R <sub>L</sub> = 2 kΩ		88	120	mV
		V <sub>id</sub> = -100 mV, R <sub>L</sub> = 600 Ω		115	160	
		V <sub>id</sub> = -100 mV, T <sub>min</sub> ≤ T <sub>amb</sub> ≤ T <sub>max</sub> , R <sub>L</sub> = 2 kΩ			120	
		V <sub>id</sub> = -100 mV, T <sub>min</sub> ≤ T <sub>amb</sub> ≤ T <sub>max</sub> , R <sub>L</sub> = 600 Ω			160	
I <sub>o</sub>	Output source current	V <sub>id</sub> = 100 mV, V <sub>O</sub> = V <sub>DD</sub>	20	80		mA
	Output sink current	V <sub>id</sub> = -100 mV, V <sub>O</sub> = V <sub>CC</sub>	20	80		
I <sub>CC</sub>	Supply current (per amplifier)	A <sub>VCL</sub> = 1, no load		420	650	μA
		T <sub>min</sub> ≤ T <sub>amb</sub> ≤ T <sub>max</sub>			690	
GBP	Gain bandwidth product	R <sub>L</sub> = 10 kΩ, C <sub>L</sub> = 100 pF, f = 100 kHz	1	1.3		MHz
SR	Slew rate	R <sub>L</sub> = 10 kΩ, C <sub>L</sub> = 100 pF	0.42	0.6		V/μs
φ <sub>m</sub>	Phase margin	C <sub>L</sub> = 100 pF		53		Degrees
e <sub>n</sub>	Input voltage noise			27		nV/√Hz
THD	Total harmonic distortion			0.01		%

Notes:

<sup>(1)</sup>Maximum values include unavoidable inaccuracies of the industrial tests.

**Table 4: Electrical characteristics at VCC = +5 V, VDD = 0 V, RL, CL connected to VCC/2, and Tamb = 25 °C (unless otherwise specified)**

Symbol	Parameter	Conditions	Min.	Typ.	Max.	Unit
V <sub>io</sub>	Input offset voltage	V <sub>icm</sub> = V <sub>out</sub> = V <sub>CC</sub> /2				mV
		TSV321/358/324		0.2	3	
		T <sub>min</sub> ≤ T <sub>amb</sub> ≤ T <sub>max</sub>			6	
		TSV321A/358A/324A		0.1	1	
		T <sub>min</sub> ≤ T <sub>amb</sub> ≤ T <sub>max</sub>			3	
ΔV <sub>io</sub> /ΔT	Input offset voltage drift			2		μV/°C
I <sub>io</sub>	Input offset current	V <sub>icm</sub> = V <sub>out</sub> = V <sub>CC</sub> /2 <sup>(1)</sup>		3	30	nA
		T <sub>min</sub> ≤ T <sub>amb</sub> ≤ T <sub>max</sub>			60	
I <sub>ib</sub>	Input bias current	V <sub>icm</sub> = V <sub>out</sub> = V <sub>CC</sub> /2 <sup>(1)</sup>		70	130	
		T <sub>min</sub> ≤ T <sub>amb</sub> ≤ T <sub>max</sub>			150	
CMR	Common mode rejection ratio 20 log (ΔV <sub>ic</sub> /ΔV <sub>io</sub> )	0 ≤ V <sub>icm</sub> ≤ V <sub>CC</sub> , V <sub>out</sub> = V <sub>CC</sub> /2	65	85		dB
SVR	Supply voltage rejection ratio 20 log (ΔV <sub>CC</sub> /ΔV <sub>io</sub> )	V <sub>CC</sub> = 2.5 V to 5 V	70	90		
A <sub>vd</sub>	Large signal voltage gain	V <sub>out</sub> = 0.5 V to 4.5 V, R <sub>L</sub> = 2 kΩ	83	92		
		V <sub>out</sub> = 0.5 V to 4.5 V, R <sub>L</sub> = 600 Ω	77	85		
V <sub>OH</sub>	High level output voltage, V <sub>OH</sub> = V <sub>out</sub>	V <sub>id</sub> = 100 mV, R <sub>L</sub> = 2 kΩ	4.80	4.95		V
		V <sub>id</sub> = 100 mV, R <sub>L</sub> = 600 Ω	4.75	4.90		
		V <sub>id</sub> = 100 mV, T <sub>min</sub> ≤ T <sub>amb</sub> ≤ T <sub>max</sub> , R <sub>L</sub> = 2 kΩ	4.80			
		V <sub>id</sub> = 100 mV, T <sub>min</sub> ≤ T <sub>amb</sub> ≤ T <sub>max</sub> , R <sub>L</sub> = 600 Ω	4.75			
V <sub>OL</sub>	Low level output voltage	V <sub>id</sub> = -100 mV, R <sub>L</sub> = 2 kΩ		88	130	mV
		V <sub>id</sub> = -100 mV, R <sub>L</sub> = 600 Ω		115	188	
		V <sub>id</sub> = -100 mV, T <sub>min</sub> ≤ T <sub>amb</sub> ≤ T <sub>max</sub> , R <sub>L</sub> = 2 kΩ			130	
		V <sub>id</sub> = -100 mV, T <sub>min</sub> ≤ T <sub>amb</sub> ≤ T <sub>max</sub> , R <sub>L</sub> = 600 Ω			188	
I <sub>o</sub>	Output source current	V <sub>id</sub> = 100 mV, V <sub>O</sub> = V <sub>DD</sub>	20	80		mA
	Output sink current	V <sub>id</sub> = -100 mV, V <sub>O</sub> = V <sub>CC</sub>	20	80		
I <sub>CC</sub>	Supply current (per amplifier)	A <sub>VCL</sub> = 1, no load		500	835	μA
		T <sub>min</sub> ≤ T <sub>amb</sub> ≤ T <sub>max</sub>			875	
GBP	Gain bandwidth product	R <sub>L</sub> = 10 kΩ, C <sub>L</sub> = 100 pF, f = 100 kHz	1	1.4		MHz
SR	Slew rate	R <sub>L</sub> = 10 kΩ, C <sub>L</sub> = 100 pF	0.42	0.6		V/μs

Symbol	Parameter	Conditions	Min.	Typ.	Max.	Unit
$\phi_m$	Phase margin	$C_L = 100 \text{ pF}$		55		Degrees
$e_n$	Input voltage noise			27		$\text{nV}/\sqrt{\text{Hz}}$
THD	Total harmonic distortion			0.01		%

**Notes:**

<sup>(1)</sup>Maximum values include unavoidable inaccuracies of the industrial tests.





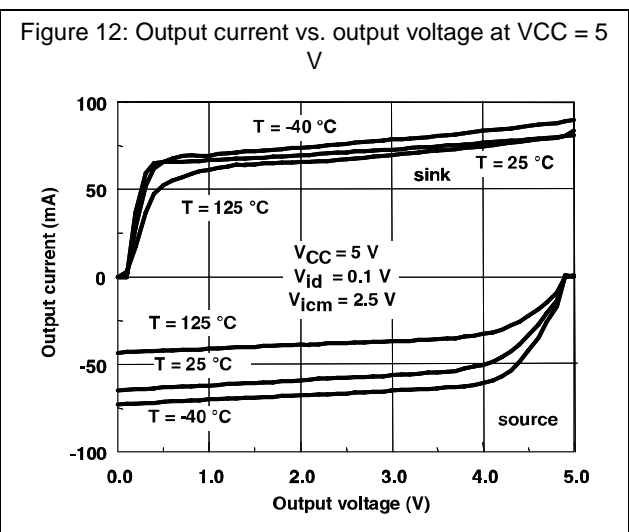
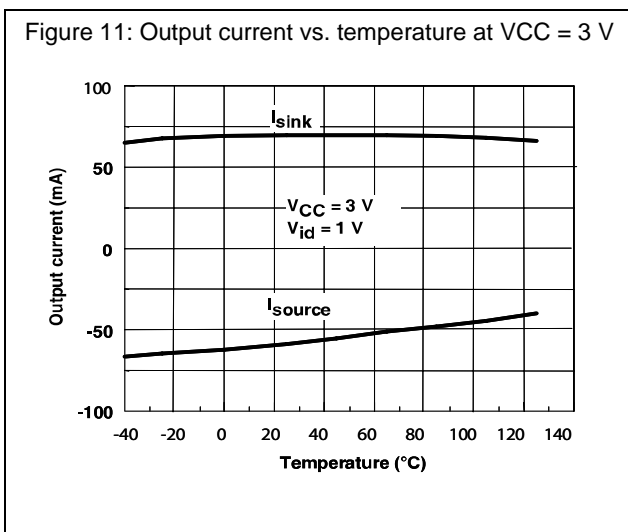
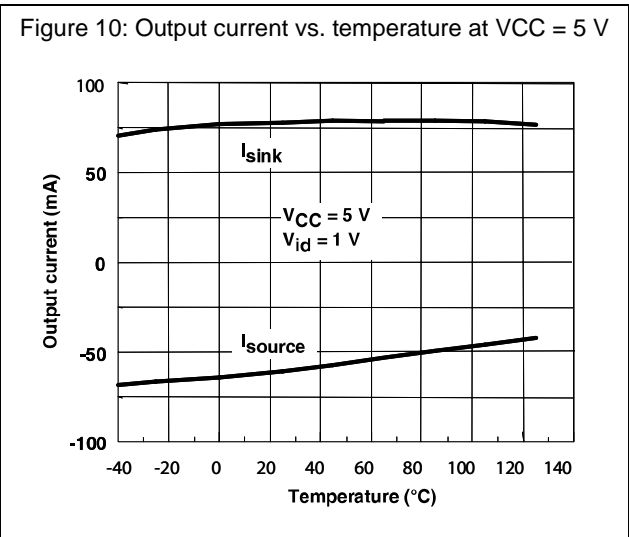
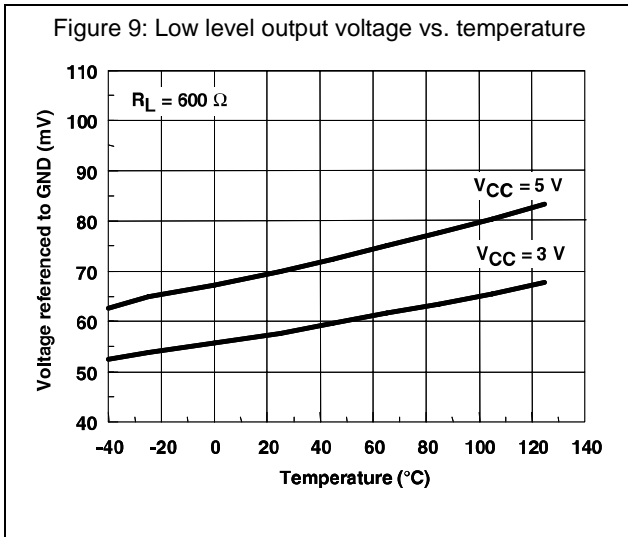
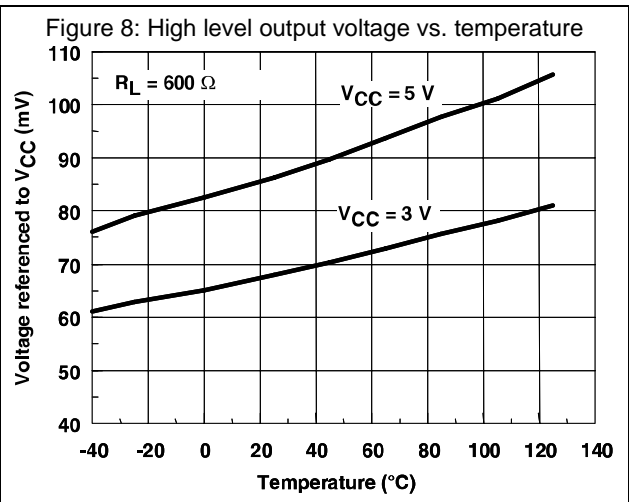
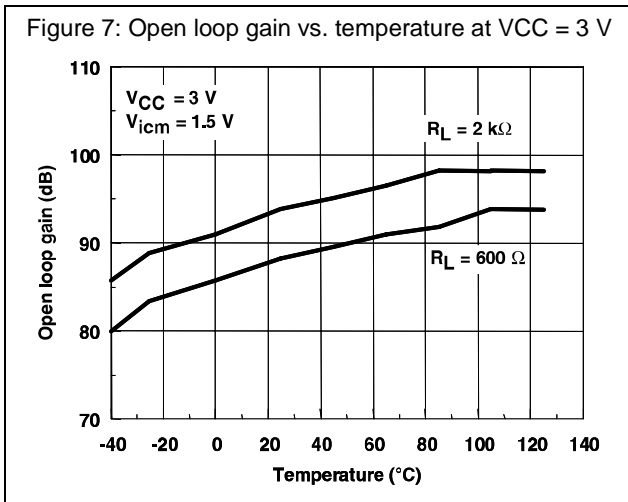



### 3 Package information

In order to meet environmental requirements, ST offers these devices in different grades of ECOPACK® packages, depending on their level of environmental compliance. ECOPACK specifications, grade definitions and product status are available at: [www.st.com](http://www.st.com). ECOPACK is an ST trademark.

### 3.1 SOT23-5 package information

Figure 19: SOT23-5 package outline



Table 5: SOT23-5 package mechanical data

Symbol	Dimensions					
	Millimeters			Mils		
	Min.	Typ.	Max.	Min.	Typ.	Max.
A	0.90		1.45	35.4		57.1
A1	0.00		0.15	0.00		5.9
A2	0.90		1.30	35.4		51.2
b	0.35		0.50	13.7		19.7
C	0.09		0.20	3.5		7.8
D	2.80		3.00	110.2		118.1
E	2.60		3.00	102.3		118.1
E1	1.50		1.75	59.0		68.8
e		0.95			37.4	
e1		1.9			74.8	
L	0.35		0.55	13.7		21.6

### 3.2 SO8 package information

Figure 20: SO8 package outline

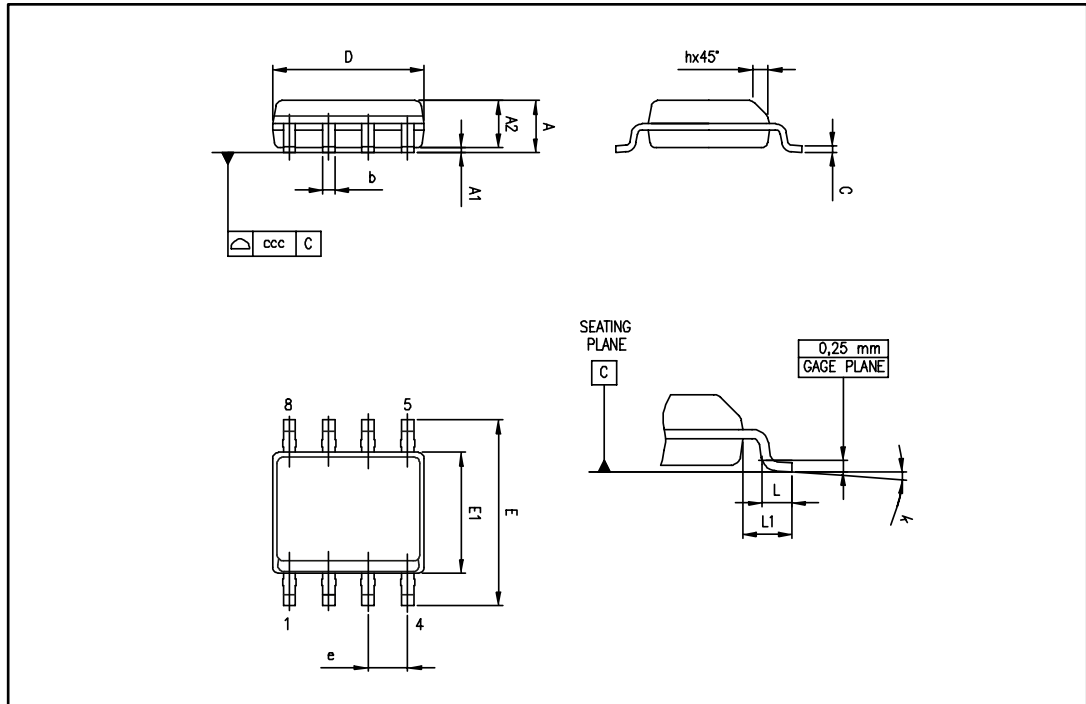

Table 6: SO8 package mechanical data

Symbol	Dimensions					
	Millimeters			Inches		
	Min.	Typ.	Max.	Min.	Typ.	Max.
A			1.75			0.069
A1	0.10		0.25	0.004		0.010
A2	1.25			0.049		
b	0.28		0.48	0.011		0.019
c	0.17		0.23	0.007		0.010
D	4.80	4.90	5.00	0.189	0.193	0.197
E	5.80	6.00	6.20	0.228	0.236	0.244
E1	3.80	3.90	4.00	0.150	0.154	0.157
e		1.27			0.050	
h	0.25		0.50	0.010		0.020
L	0.40		1.27	0.016		0.050
k	1°		8°	1°		8°
ccc			0.10			0.004

### 3.3 MiniSO8 package information

Figure 21: MiniSO8 package outline



Table 7: MiniSO8 package mechanical data

Symbol	Dimensions					
	Millimeters			Inches		
	Min.	Typ.	Max.	Min.	Typ.	Max.
A			1.1			0.043
A1	0		0.15	0		0.006
A2	0.75	0.85	0.95	0.030	0.033	0.037
b	0.22		0.40	0.009		0.016
c	0.08		0.23	0.003		0.009
D	2.80	3.00	3.20	0.11	0.118	0.126
E	4.65	4.90	5.15	0.183	0.193	0.203
E1	2.80	3.00	3.10	0.11	0.118	0.122
e		0.65			0.026	
L	0.40	0.60	0.80	0.016	0.024	0.031
L1		0.95			0.037	
L2		0.25			0.010	
k	0°		8°	0°		8°
ccc			0.10			0.004

### 3.4 TSSOP8 package information

Figure 22: TSSOP8 package outline



Table 8: TSSOP8 package mechanical data

Symbol	Dimensions					
	Millimeters			Inches		
	Min.	Typ.	Max.	Min.	Typ.	Max.
A			1.2			0.047
A1	0.05		0.15	0.002		0.006
A2	0.80	1.00	1.05	0.031	0.039	0.041
b	0.19		0.30	0.007		0.012
c	0.09		0.20	0.004		0.008
D	2.90	3.00	3.10	0.114	0.118	0.122
E	6.20	6.40	6.60	0.244	0.252	0.260
E1	4.30	4.40	4.50	0.169	0.173	0.177
e		0.65			0.0256	
k	0°		8°	0°		8°
L	0.45	0.60	0.75	0.018	0.024	0.030
L1		1			0.039	
aaa		0.1			0.004	

### 3.5 SO14 package information

Figure 23: SO14 package outline



Table 9: SO14 package mechanical data

Symbol	Dimensions					
	Millimeters			Inches		
	Min.	Typ.	Max.	Min.	Typ.	Max.
A			1.75			0.068
a1	0.1		0.2	0.003		0.007
a2			1.65			0.064
b	0.35		0.46	0.013		0.018
b1	0.19		0.25	0.007		0.010
C		0.5			0.019	
c1	45° (typ.)					
D	8.55		8.75	0.336		0.344
E	5.8		6.2	0.228		0.244
e		1.27			0.050	
e3		7.62			0.300	
F	3.8		4.0	0.149		0.157
G	4.6		5.3	0.181		0.208
L	0.5		1.27	0.019		0.050
M			0.68			0.026
S	8° (max.)					



### 3.6 TSSOP14 package information

Figure 24: TSSOP14 package outline



Table 10: TSSOP14 package mechanical data

Symbol	Dimensions					
	Millimeters			Inches		
	Min.	Typ.	Max.	Min.	Typ.	Max.
A			1.2			0.047
A1	0.05		0.15	0.002	0.004	0.006
A2	0.8	1	1.05	0.031	0.039	0.041
b	0.19		0.30	0.007		0.012
c	0.09		0.20	0.004		0.0089
D	4.9	5	5.1	0.193	0.197	0.201
E	6.2	6.4	6.6	0.244	0.252	0.260
E1	4.3	4.4	4.48	0.169	0.173	0.176
e		0.65 BSC			0.0256 BSC	
K	0°		8°	0°		8°
L1	0.45	0.60	0.75	0.018	0.024	0.030

## 4 Ordering information

Table 11: Order codes

Order code	Temperature range	Package	Packaging	Marking	
TSV321RILT	-40 °C to +125 °C	SOT23-5	Tape and reel	K174	
TSV321RAILT				K178	
TSV321RIYLT <sup>(1)</sup>				SOT23-5 (automotive grade level)	K179
TSV321RAIYLT <sup>(1)</sup>					K187
TSV321IDT		SO8		V321ID	
TSV321AIDT				V321AI	
TSV358IDT				V358ID	
TSV358AIDT				V358AID	
TSV358IYDT <sup>(1)</sup>				SO8 (automotive grade level)	V358YD
TSV358AIYDT <sup>(1)</sup>					V358AY
TSV358IPT				TSSOP8 (thin shrink outline package)	V358I
TSV358AIPT					V358A
TSV358IYPT <sup>(1)</sup>		TSSOP8 (automotive grade level)		V358Y	
TSV358AIYPT <sup>(1)</sup>				V58AY	
TSV358IST		MiniSO8		K175	
TSV358AIST				K184	
TSV324IDT		SO14		V324ID	
TSV324AIDT				V324AI	
TSV324IYDT <sup>(1)</sup>		SO14 (automotive grade level)		V324YD	
TSV324AIYDT <sup>(1)</sup>				V324AY	
TSV324IPT	TSSOP14 (thin shrink outline package)	V324IP			
TSV324AIPT		V324A			
TSV324AIYPT <sup>(1)</sup>	TSSOP14 (automotive grade level)	V324AY			
TSV324IYPT <sup>(1)</sup>		V324Y			

**Notes:**

<sup>(1)</sup> Qualified and characterized according to AEC Q100 and Q003 or equivalent, advanced screening according to AEC Q001 and Q 002 or equivalent.

## 5 Revision history

Table 12: Document revision history

Date	Revision	Changes
2-Aug-2005	1	First release - Products in full production.
20-Sep-2005	2	Addition of TS321A/TS324A/TS358A data in tables in <a href="#">Section 2: "Electrical characteristics"</a> . Minor formatting and grammatical changes.
7-Dec-2005	3	Missing PPAP references inserted see <a href="#">Section 4: "Ordering information"</a> .
28-Jun-2007	4	Correction made on output drive capability, 80mA in description on cover page. SVR measurement conditions inserted in electrical characteristics tables. Offset voltage limit in temperature added in <a href="#">Section 2: "Electrical characteristics"</a> . Correction made on Input Bias Current typical value in <a href="#">Section 2: "Electrical characteristics"</a> . Captions of electrical characteristics figures updated. Automotive grade order codes added to <a href="#">Section 4: "Ordering information"</a> .
21-Feb-2008	5	Corrected SO-14 $R_{thja}$ value to 105 °C/W. Updated presentation of package information. Corrected footnote for automotive grade order codes in order code table.
13-Sep-2012	6	Updated <a href="#">Features</a> (added SO-8, SO-14, TSSOP8, TSSOP14, and MiniSO-8 package). Updated "Pin connection" figure on page 1 (removed part numbers). Removed TSV321ID, TSV321AID, TSV321IYDT, TSV358ID, TSV358AID, TSV324ID, TSV324AID, TSV321IYD, TSV358IYD, TSV358AIYD, TSV321IYD, TSV324IYD, and TSV324AIYD order code from <a href="#">Table 11: "Order codes"</a> . Qualified status of TSV324AIYPT, TSV324IYPT, TSV324IYDT, TSV324AIYDT, TSV358IYDT, TSV321RIYLT, TSV321RAIYLT, and TSV358AIYDT order code in <a href="#">Table 11: "Order codes"</a> . Updated ECOPACK text in <a href="#">Section 3: "Package information"</a> . Minor corrections throughout document.
16-Aug-2013	7	Updated <a href="#">Features</a> Added <a href="#">Related products</a> <a href="#">Table 3</a> and <a href="#">Table 4</a> : replaced $\Delta V_{io}$ with $\Delta V_{io}/\Delta T$ <a href="#">Table 11: "Order codes"</a> : order code TSV321IDT renamed TSV321AIDT, added order code TSV358AIDT, updated footnote associated with order codes TSV358IYPT and TSV358AIYPT.

**Revision history****TSV321, TSV358, TSV324, TSV321A, TSV358A,  
TSV324A,**

Date	Revision	Changes
27-Jun-2014	8	Added part numbers TSV321A, TSV358A, and TSV324A. <i>Table 6: "SO8 package mechanical data"</i> : added L1 dimensions <i>Table 11: "Order codes"</i> : removed "tube" from all packaging Updated disclaimer

**Please Read Carefully**

Information in this document is provided solely in connection with ST products. STMicroelectronics NV and its subsidiaries ("ST") reserve the right to make changes, corrections, modifications or improvements, to this document, and the products and services described herein at any time, without notice.

All ST products are sold pursuant to ST's terms and conditions of sale.

Purchasers are solely responsible for the choice, selection and use of the ST products and services described herein, and ST assumes no liability whatsoever relating to the choice, selection or use of the ST products and services described herein.

No license, express or implied, by estoppel or otherwise, to any intellectual property rights is granted under this document. If any part of this document refers to any third party products or services it shall not be deemed a license grant by ST for the use of such third party products or services, or any intellectual property contained therein or considered as a warranty covering the use in any manner whatsoever of such third party products or services or any intellectual property contained therein.

**UNLESS OTHERWISE SET FORTH IN ST'S TERMS AND CONDITIONS OF SALE ST DISCLAIMS ANY EXPRESS OR IMPLIED WARRANTY WITH RESPECT TO THE USE AND/OR SALE OF ST PRODUCTS INCLUDING WITHOUT LIMITATION IMPLIED WARRANTIES OF MERCHANTABILITY, FITNESS FOR A PARTICULAR PURPOSE (AND THEIR EQUIVALENTS UNDER THE LAWS OF ANY JURISDICTION), OR INFRINGEMENT OF ANY PATENT, COPYRIGHT OR OTHER INTELLECTUAL PROPERTY RIGHT.**

**ST PRODUCTS ARE NOT DESIGNED OR AUTHORIZED FOR USE IN: (A) SAFETY CRITICAL APPLICATIONS SUCH AS LIFE SUPPORTING, ACTIVE IMPLANTED DEVICES OR SYSTEMS WITH PRODUCT FUNCTIONAL SAFETY REQUIREMENTS; (B) AERONAUTIC APPLICATIONS; (C) AUTOMOTIVE APPLICATIONS OR ENVIRONMENTS, AND/OR (D) AEROSPACE APPLICATIONS OR ENVIRONMENTS. WHERE ST PRODUCTS ARE NOT DESIGNED FOR SUCH USE, THE PURCHASER SHALL USE PRODUCTS AT PURCHASER'S SOLE RISK, EVEN IF ST HAS BEEN INFORMED IN WRITING OF SUCH USAGE, UNLESS A PRODUCT IS EXPRESSLY DESIGNATED BY ST AS BEING INTENDED FOR "AUTOMOTIVE, AUTOMOTIVE SAFETY OR MEDICAL" INDUSTRY DOMAINS ACCORDING TO ST PRODUCT DESIGN SPECIFICATIONS. PRODUCTS FORMALLY ESCC, QML OR JAN QUALIFIED ARE DEEMED SUITABLE FOR USE IN AEROSPACE BY THE CORRESPONDING GOVERNMENTAL AGENCY.**

Resale of ST products with provisions different from the statements and/or technical features set forth in this document shall immediately void any warranty granted by ST for the ST product or service described herein and shall not create or extend in any manner whatsoever, any liability of ST.

ST and the ST logo are trademarks or registered trademarks of ST in various countries.

Information in this document supersedes and replaces all information previously supplied.

The ST logo is a registered trademark of STMicroelectronics. All other names are the property of their respective owners.

© 2014 STMicroelectronics - All rights reserved

STMicroelectronics group of companies

Australia - Belgium - Brazil - Canada - China - Czech Republic - Finland - France - Germany - Hong Kong - India - Israel - Italy - Japan - Malaysia - Malta - Morocco - Philippines - Singapore - Spain - Sweden - Switzerland - United Kingdom - United States of America

[www.st.com](http://www.st.com)

Компания «Life Electronics» занимается поставками электронных компонентов импортного и отечественного производства от производителей и со складов крупных дистрибьюторов Европы, Америки и Азии.

С конца 2013 года компания активно расширяет линейку поставок компонентов по направлению коаксиальный кабель, кварцевые генераторы и конденсаторы (керамические, пленочные, электролитические), за счёт заключения дистрибьюторских договоров

Мы предлагаем:

- Конкурентоспособные цены и скидки постоянным клиентам.
- Специальные условия для постоянных клиентов.
- Подбор аналогов.
- Поставку компонентов в любых объемах, удовлетворяющих вашим потребностям.
- Приемлемые сроки поставки, возможна ускоренная поставка.
- Доставку товара в любую точку России и стран СНГ.
- Комплексную поставку.
- Работу по проектам и поставку образцов.
- Формирование склада под заказчика.
- Сертификаты соответствия на поставляемую продукцию (по желанию клиента).
- Тестирование поставляемой продукции.
- Поставку компонентов, требующих военную и космическую приемку.
- Входной контроль качества.
- Наличие сертификата ISO.

В составе нашей компании организован Конструкторский отдел, призванный помогать разработчикам, и инженерам.

Конструкторский отдел помогает осуществить:

- Регистрацию проекта у производителя компонентов.
- Техническую поддержку проекта.
- Защиту от снятия компонента с производства.
- Оценку стоимости проекта по компонентам.
- Изготовление тестовой платы монтаж и пусконаладочные работы.



Тел: +7 (812) 336 43 04 (многоканальный)  
Email: org@lifeelectronics.ru