

General purpose input/output rail-to-rail low-power operational amplifiers

Datasheet - production data



Features

- Operating range $V_{CC} = 2.5\text{ V to }6\text{ V}$
- Rail-to-rail input and output
- Extended V_{icm} ($V_{DD} - 0.2\text{ V to }V_{CC} + 0.2\text{ V}$)
- Capable of driving a $32\ \Omega$ load resistor
- High stability: 500 pF
- Operating temperature range: $-40\text{ to }125\text{ }^\circ\text{C}$

Related products

- See LMV321L, LMV358L, LMV324L for newer technology version
- See TSV851, TSV852, TSV854 for enhanced performances

Applications

- Battery powered applications
- Audio driver (headphone driver)
- Sensor signal conditioning
- Laptop/notebook computers

Description

The TSV358, TSV358A, TSV324, and TSV324A (dual and quad) devices are low voltage versions of the LM358 and LM324 commodity operational amplifiers. The TSV321 and TSV321A are the single version. All devices operate with voltages as low as 2.5 V and feature both I/O rail-to-rail.

The common mode input voltage extends 200 mV beyond the supply voltages at $25\text{ }^\circ\text{C}$ while the output voltage swing is within 100 mV of each rail with a $600\ \Omega$ load resistor. At $V_{CC} = 3\text{ V}$, these devices offer 1.3 MHz of gain bandwidth product and provide high output current capability with a typical value of 80 mA .

These features make the TSV3xx and TSV3xxA family ideal for active filters, general purpose low voltage applications, and general purpose portable devices.

Contents

| | | |
|----------|--|-----------|
| 1 | Absolute maximum ratings and operating conditions | 3 |
| 2 | Electrical characteristics | 5 |
| 3 | Package information | 11 |
| 3.1 | SOT23-5 package information | 12 |
| 3.2 | SO8 package information..... | 13 |
| 3.3 | MiniSO8 package information | 14 |
| 3.4 | TSSOP8 package information..... | 15 |
| 3.5 | SO14 package information..... | 16 |
| 3.6 | TSSOP14 package information..... | 17 |
| 4 | Ordering information..... | 18 |
| 5 | Revision history | 19 |

1 Absolute maximum ratings and operating conditions

Table 1: Absolute maximum ratings

| Symbol | Parameter | Value | Unit | |
|------------|--|----------------------------------|------|------|
| V_{CC} | Supply voltage ⁽¹⁾ | 7 | V | |
| V_{id} | Differential input voltage ⁽²⁾ | ±1 | | |
| V_{in} | Input voltage | $V_{DD} - 0.3$ to $V_{CC} + 0.3$ | | |
| T_{stg} | Storage temperature | -65 to +150 | °C | |
| T_j | Maximum junction temperature | 150 | | |
| R_{thja} | Thermal resistance junction-to-ambient ⁽³⁾ | SOT23-5 | 250 | °C/W |
| | | SO8 | 125 | |
| | | MiniSO8 | 190 | |
| | | TSSOP8 | 120 | |
| | | SO14 | 105 | |
| | | TSSOP14 | 100 | |
| R_{thjc} | Thermal resistance junction-to-case ⁽³⁾ | SOT23-5 | 81 | |
| | | SO8 | 40 | |
| | | MiniSO8 | 39 | |
| | | TSSOP8 | 37 | |
| | | SO14 | 31 | |
| | | TSSOP14 | 32 | |
| ESD | HBM: human body model ⁽⁴⁾ | 2 | kV | |
| | MM: machine model ⁽⁵⁾ | 200 | V | |
| | CDM: charged device model ⁽⁶⁾ | 1.5 | kV | |
| | Latch-up immunity | 200 | mA | |
| | Lead temperature (soldering, 10 s) | 250 | °C | |
| | Output short-circuit duration | See ⁽⁷⁾ | | |

Notes:

⁽¹⁾All voltage values, except the differential voltage are with respect to the network terminal.

⁽²⁾The differential voltage is the non-inverting input terminal with respect to the inverting input terminal. If $V_{id} > \pm 1$ V, the maximum input current must not exceed ± 1 mA. When $V_{id} > \pm 1$ V, an input series resistor must be added to limit input current.

⁽³⁾Short-circuits can cause excessive heating and destructive dissipation. R_{th} are typical values.

⁽⁴⁾Human body model: 100 pF discharged through a 1.5 kΩ resistor between two pins of the device, done for all couples of pin combinations with other pins floating.

⁽⁵⁾Machine model: a 200 pF capacitor is charged to the specified voltage, then discharged directly between two pins of the device with no external series resistor (internal resistor < 5 Ω), done for all couples of pin combinations with other pins floating.

⁽⁶⁾Charged device model: all pins plus package are charged together to the specified voltage and then discharged directly to ground.

⁽⁷⁾Short-circuits from the output to V_{CC} can cause excessive heating. The maximum output current is approximately 80 mA, independent of the magnitude of V_{CC} . Destructive dissipation can result from simultaneous short-circuits on all amplifiers.

Table 2: Operating conditions

| Symbol | Parameter | | Value | Unit |
|------------|--------------------------------------|---|----------------------------------|--------------------|
| V_{CC} | Supply voltage | | 2.5 to 6 | V |
| V_{icm} | Common mode input voltage range | $T_{amb} = 25\text{ }^{\circ}\text{C}, 2.5 \leq V_{CC} \leq 6\text{ V}$ | $V_{DD} - 0.2$ to $V_{CC} + 0.2$ | V |
| | | $T_{min} < T_{amb} < T_{max}, 2.5 \leq V_{CC} \leq 5.5\text{ V}$ | V_{DD} to V_{CC} | |
| T_{oper} | Operating free air temperature range | | -40 to + 125 | $^{\circ}\text{C}$ |

2 Electrical characteristics

Table 3: Electrical characteristics at VCC = +3 V, VDD = 0 V, RL, CL connected to VCC/2, and Tamb = 25 °C (unless otherwise specified)

| Symbol | Parameter | Test conditions | Min. | Typ. | Max. | Unit |
|----------------------|--|--|------|------|------|---------|
| V _{io} | Input offset voltage | V _{icm} = V _{out} = V _{CC} /2 | | | | mV |
| | | TSV321/358/324 | | 0.2 | 3 | |
| | | T _{min} ≤ T _{amb} ≤ T _{max} | | | 6 | |
| | | TSV321A/358A/324A | | 0.1 | 1 | |
| | | T _{min} ≤ T _{amb} ≤ T _{max} | | | 3 | |
| ΔV _{io} /ΔT | Input offset voltage drift | | | 2 | | μV/°C |
| I _{io} | Input offset current | V _{icm} = V _{out} = V _{CC} /2 ⁽¹⁾ | | 3 | 30 | nA |
| | | T _{min} ≤ T _{amb} ≤ T _{max} | | | 60 | |
| I _{ib} | Input bias current | V _{icm} = V _{out} = V _{CC} /2 ⁽¹⁾ | | 40 | 125 | |
| | | T _{min} ≤ T _{amb} ≤ T _{max} | | | 150 | |
| CMR | Common mode rejection ratio 20 log (ΔV _{ic} /ΔV _{io}) | 0 ≤ V _{icm} ≤ V _{CC} , V _{out} = V _{CC} /2 | 60 | 80 | | dB |
| A _{vd} | Large signal voltage gain | V _{out} = 0.5 V to 2.5 V, R _L = 2 kΩ | 80 | 92 | | |
| | | V _{out} = 0.5 V to 2.5 V, R _L = 600 Ω | 74 | 95 | | |
| V _{OH} | High level output voltage, V _{OH} = V _{out} | V _{id} = 100 mV, R _L = 2 kΩ | 2.82 | 2.95 | | V |
| | | V _{id} = 100 mV, R _L = 600 Ω | 2.80 | 2.95 | | |
| | | V _{id} = 100 mV, T _{min} ≤ T _{amb} ≤ T _{max} , R _L = 2 kΩ | 2.82 | | | |
| | | V _{id} = 100 mV, T _{min} ≤ T _{amb} ≤ T _{max} , R _L = 600 Ω | 2.80 | | | |
| V _{OL} | Low level output voltage | V _{id} = -100 mV, R _L = 2 kΩ | | 88 | 120 | mV |
| | | V _{id} = -100 mV, R _L = 600 Ω | | 115 | 160 | |
| | | V _{id} = -100 mV, T _{min} ≤ T _{amb} ≤ T _{max} , R _L = 2 kΩ | | | 120 | |
| | | V _{id} = -100 mV, T _{min} ≤ T _{amb} ≤ T _{max} , R _L = 600 Ω | | | 160 | |
| I _o | Output source current | V _{id} = 100 mV, V _O = V _{DD} | 20 | 80 | | mA |
| | Output sink current | V _{id} = -100 mV, V _O = V _{CC} | 20 | 80 | | |
| I _{CC} | Supply current (per amplifier) | A _{VCL} = 1, no load | | 420 | 650 | μA |
| | | T _{min} ≤ T _{amb} ≤ T _{max} | | | 690 | |
| GBP | Gain bandwidth product | R _L = 10 kΩ, C _L = 100 pF, f = 100 kHz | 1 | 1.3 | | MHz |
| SR | Slew rate | R _L = 10 kΩ, C _L = 100 pF | 0.42 | 0.6 | | V/μs |
| φ _m | Phase margin | C _L = 100 pF | | 53 | | Degrees |
| e _n | Input voltage noise | | | 27 | | nV/√Hz |
| THD | Total harmonic distortion | | | 0.01 | | % |

Notes:

⁽¹⁾Maximum values include unavoidable inaccuracies of the industrial tests.

Table 4: Electrical characteristics at VCC = +5 V, VDD = 0 V, RL, CL connected to VCC/2, and Tamb = 25 °C (unless otherwise specified)

| Symbol | Parameter | Conditions | Min. | Typ. | Max. | Unit |
|----------------------|---|--|------|------|------|-------|
| V _{io} | Input offset voltage | V _{icm} = V _{out} = V _{CC} /2 | | | | mV |
| | | TSV321/358/324 | | 0.2 | 3 | |
| | | T _{min} ≤ T _{amb} ≤ T _{max} | | | 6 | |
| | | TSV321A/358A/324A | | 0.1 | 1 | |
| | | T _{min} ≤ T _{amb} ≤ T _{max} | | | 3 | |
| ΔV _{io} /ΔT | Input offset voltage drift | | | 2 | | μV/°C |
| I _{io} | Input offset current | V _{icm} = V _{out} = V _{CC} /2 ⁽¹⁾ | | 3 | 30 | nA |
| | | T _{min} ≤ T _{amb} ≤ T _{max} | | | 60 | |
| I _{ib} | Input bias current | V _{icm} = V _{out} = V _{CC} /2 ⁽¹⁾ | | 70 | 130 | |
| | | T _{min} ≤ T _{amb} ≤ T _{max} | | | 150 | |
| CMR | Common mode rejection ratio 20 log (ΔV _{ic} /ΔV _{io}) | 0 ≤ V _{icm} ≤ V _{CC} , V _{out} = V _{CC} /2 | 65 | 85 | | dB |
| SVR | Supply voltage rejection ratio 20 log (ΔV _{CC} /ΔV _{io}) | V _{CC} = 2.5 V to 5 V | 70 | 90 | | |
| A _{vd} | Large signal voltage gain | V _{out} = 0.5 V to 4.5 V, R _L = 2 kΩ | 83 | 92 | | |
| | | V _{out} = 0.5 V to 4.5 V, R _L = 600 Ω | 77 | 85 | | |
| V _{OH} | High level output voltage, V _{OH} = V _{out} | V _{id} = 100 mV, R _L = 2 kΩ | 4.80 | 4.95 | | V |
| | | V _{id} = 100 mV, R _L = 600 Ω | 4.75 | 4.90 | | |
| | | V _{id} = 100 mV, T _{min} ≤ T _{amb} ≤ T _{max} , R _L = 2 kΩ | 4.80 | | | |
| | | V _{id} = 100 mV, T _{min} ≤ T _{amb} ≤ T _{max} , R _L = 600 Ω | 4.75 | | | |
| V _{OL} | Low level output voltage | V _{id} = -100 mV, R _L = 2 kΩ | | 88 | 130 | mV |
| | | V _{id} = -100 mV, R _L = 600 Ω | | 115 | 188 | |
| | | V _{id} = -100 mV, T _{min} ≤ T _{amb} ≤ T _{max} , R _L = 2 kΩ | | | 130 | |
| | | V _{id} = -100 mV, T _{min} ≤ T _{amb} ≤ T _{max} , R _L = 600 Ω | | | 188 | |
| I _o | Output source current | V _{id} = 100 mV, V _O = V _{DD} | 20 | 80 | | mA |
| | Output sink current | V _{id} = -100 mV, V _O = V _{CC} | 20 | 80 | | |
| I _{CC} | Supply current (per amplifier) | A _{VCL} = 1, no load | | 500 | 835 | μA |
| | | T _{min} ≤ T _{amb} ≤ T _{max} | | | 875 | |
| GBP | Gain bandwidth product | R _L = 10 kΩ, C _L = 100 pF, f = 100 kHz | 1 | 1.4 | | MHz |
| SR | Slew rate | R _L = 10 kΩ, C _L = 100 pF | 0.42 | 0.6 | | V/μs |

| Symbol | Parameter | Conditions | Min. | Typ. | Max. | Unit |
|----------|---------------------------|------------------------|------|------|------|------------------------------|
| ϕ_m | Phase margin | $C_L = 100 \text{ pF}$ | | 55 | | Degrees |
| e_n | Input voltage noise | | | 27 | | $\text{nV}/\sqrt{\text{Hz}}$ |
| THD | Total harmonic distortion | | | 0.01 | | % |

Notes:

⁽¹⁾Maximum values include unavoidable inaccuracies of the industrial tests.

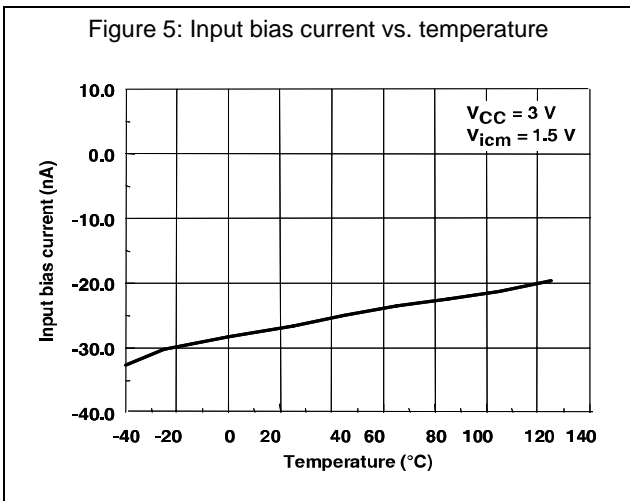
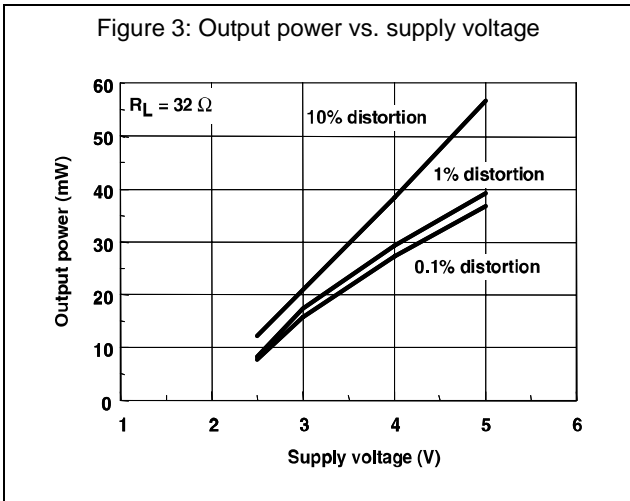
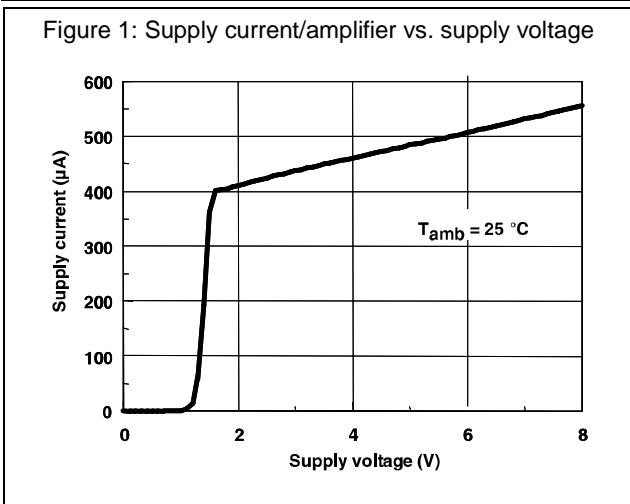

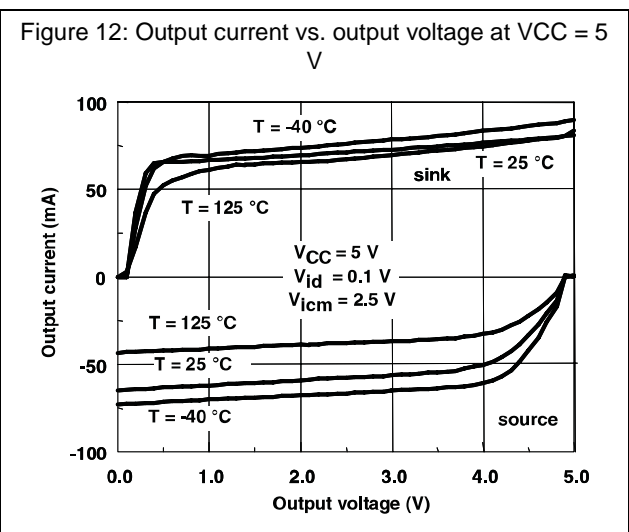
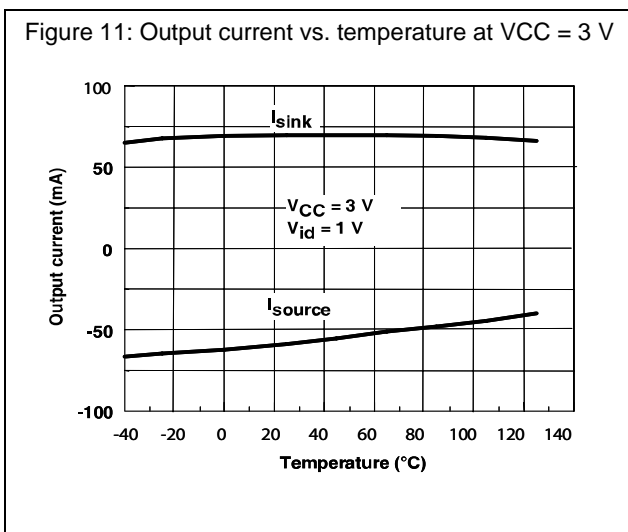
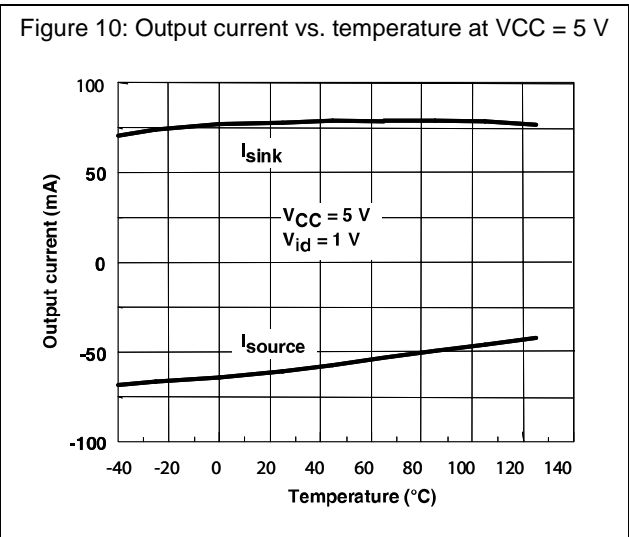
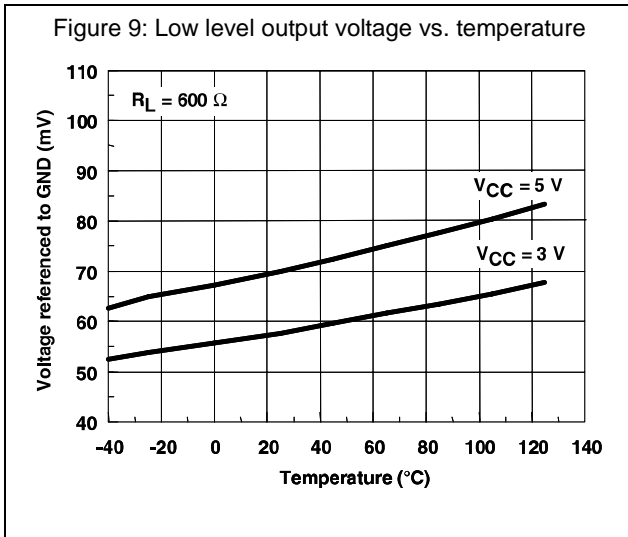
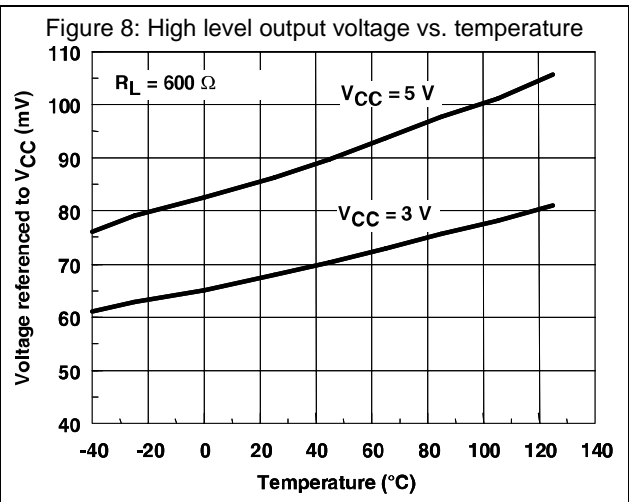
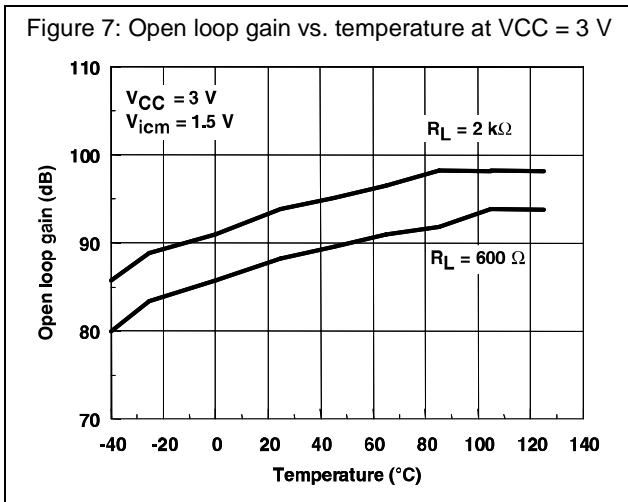

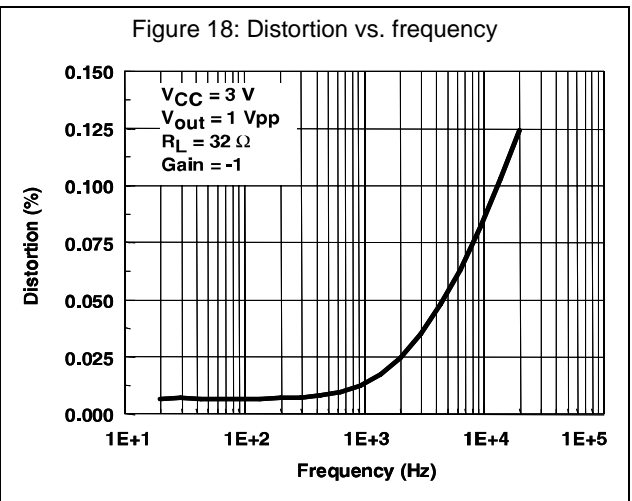
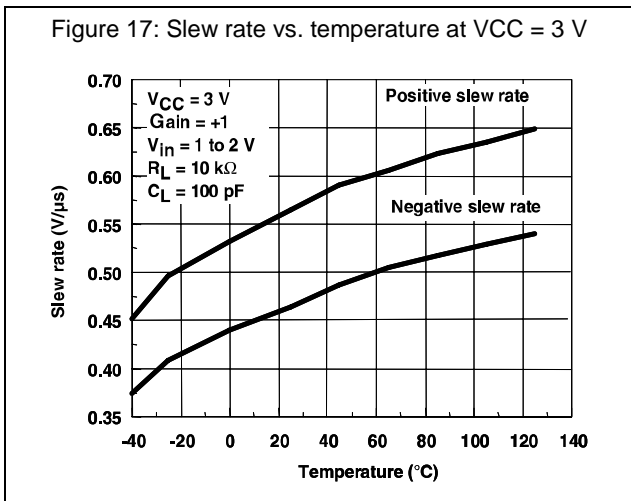
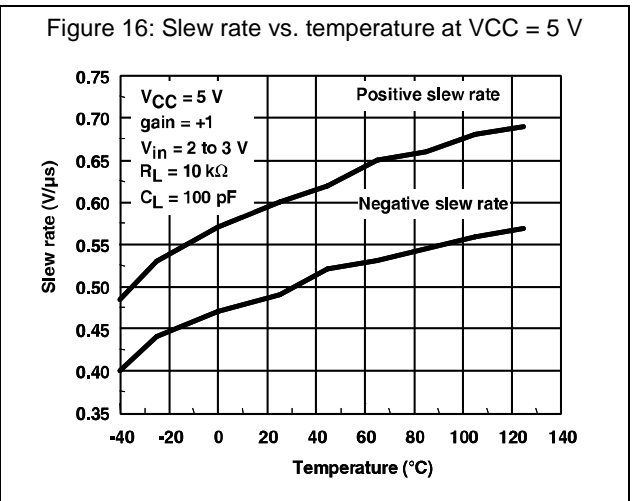
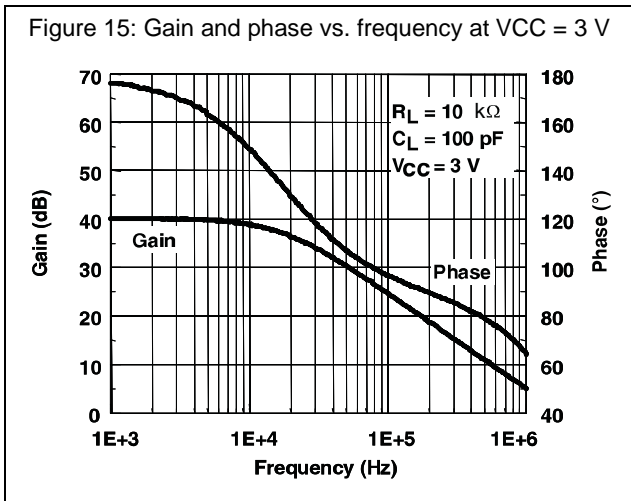

3 Package information

In order to meet environmental requirements, ST offers these devices in different grades of ECOPACK® packages, depending on their level of environmental compliance. ECOPACK specifications, grade definitions and product status are available at: www.st.com. ECOPACK is an ST trademark.

3.1 SOT23-5 package information

Figure 19: SOT23-5 package outline

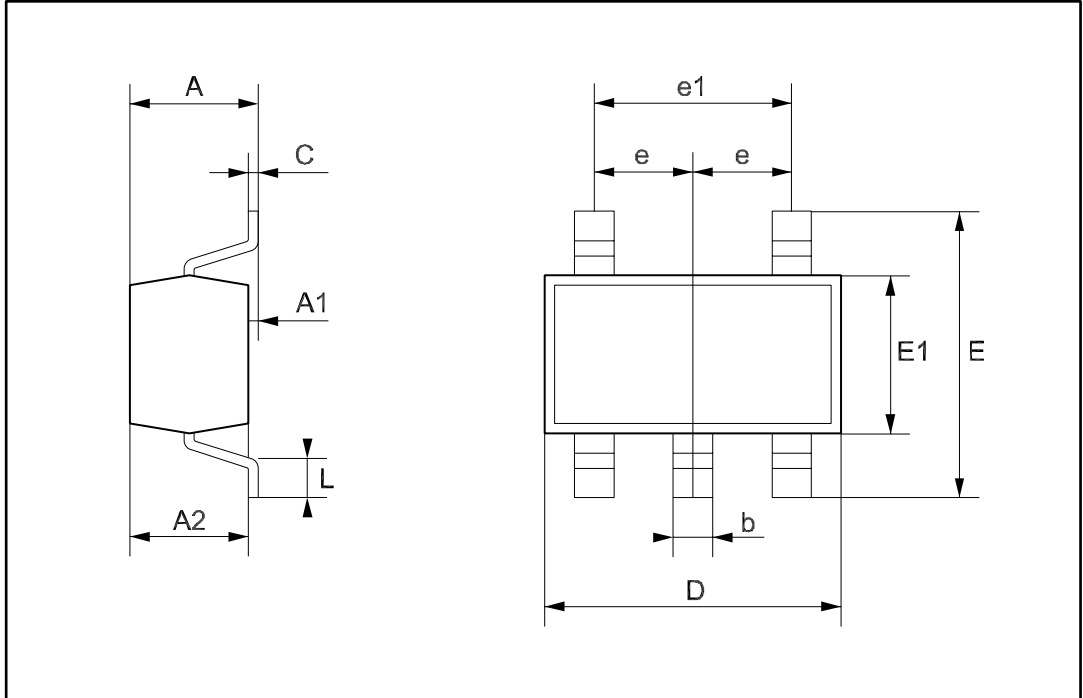

Table 5: SOT23-5 package mechanical data

| Symbol | Dimensions | | | | | |
|--------|-------------|------|------|-------|------|-------|
| | Millimeters | | | Mils | | |
| | Min. | Typ. | Max. | Min. | Typ. | Max. |
| A | 0.90 | | 1.45 | 35.4 | | 57.1 |
| A1 | 0.00 | | 0.15 | 0.00 | | 5.9 |
| A2 | 0.90 | | 1.30 | 35.4 | | 51.2 |
| b | 0.35 | | 0.50 | 13.7 | | 19.7 |
| C | 0.09 | | 0.20 | 3.5 | | 7.8 |
| D | 2.80 | | 3.00 | 110.2 | | 118.1 |
| E | 2.60 | | 3.00 | 102.3 | | 118.1 |
| E1 | 1.50 | | 1.75 | 59.0 | | 68.8 |
| e | | 0.95 | | | 37.4 | |
| e1 | | 1.9 | | | 74.8 | |
| L | 0.35 | | 0.55 | 13.7 | | 21.6 |

3.2 SO8 package information

Figure 20: SO8 package outline



Table 6: SO8 package mechanical data

| Symbol | Dimensions | | | | | |
|--------|-------------|------|------|--------|-------|-------|
| | Millimeters | | | Inches | | |
| | Min. | Typ. | Max. | Min. | Typ. | Max. |
| A | | | 1.75 | | | 0.069 |
| A1 | 0.10 | | 0.25 | 0.004 | | 0.010 |
| A2 | 1.25 | | | 0.049 | | |
| b | 0.28 | | 0.48 | 0.011 | | 0.019 |
| c | 0.17 | | 0.23 | 0.007 | | 0.010 |
| D | 4.80 | 4.90 | 5.00 | 0.189 | 0.193 | 0.197 |
| E | 5.80 | 6.00 | 6.20 | 0.228 | 0.236 | 0.244 |
| E1 | 3.80 | 3.90 | 4.00 | 0.150 | 0.154 | 0.157 |
| e | | 1.27 | | | 0.050 | |
| h | 0.25 | | 0.50 | 0.010 | | 0.020 |
| L | 0.40 | | 1.27 | 0.016 | | 0.050 |
| k | 1° | | 8° | 1° | | 8° |
| ccc | | | 0.10 | | | 0.004 |

3.3 MiniSO8 package information

Figure 21: MiniSO8 package outline



Table 7: MiniSO8 package mechanical data

| Symbol | Dimensions | | | | | |
|--------|-------------|------|------|--------|-------|-------|
| | Millimeters | | | Inches | | |
| | Min. | Typ. | Max. | Min. | Typ. | Max. |
| A | | | 1.1 | | | 0.043 |
| A1 | 0 | | 0.15 | 0 | | 0.006 |
| A2 | 0.75 | 0.85 | 0.95 | 0.030 | 0.033 | 0.037 |
| b | 0.22 | | 0.40 | 0.009 | | 0.016 |
| c | 0.08 | | 0.23 | 0.003 | | 0.009 |
| D | 2.80 | 3.00 | 3.20 | 0.11 | 0.118 | 0.126 |
| E | 4.65 | 4.90 | 5.15 | 0.183 | 0.193 | 0.203 |
| E1 | 2.80 | 3.00 | 3.10 | 0.11 | 0.118 | 0.122 |
| e | | 0.65 | | | 0.026 | |
| L | 0.40 | 0.60 | 0.80 | 0.016 | 0.024 | 0.031 |
| L1 | | 0.95 | | | 0.037 | |
| L2 | | 0.25 | | | 0.010 | |
| k | 0° | | 8° | 0° | | 8° |
| ccc | | | 0.10 | | | 0.004 |

3.4 TSSOP8 package information

Figure 22: TSSOP8 package outline

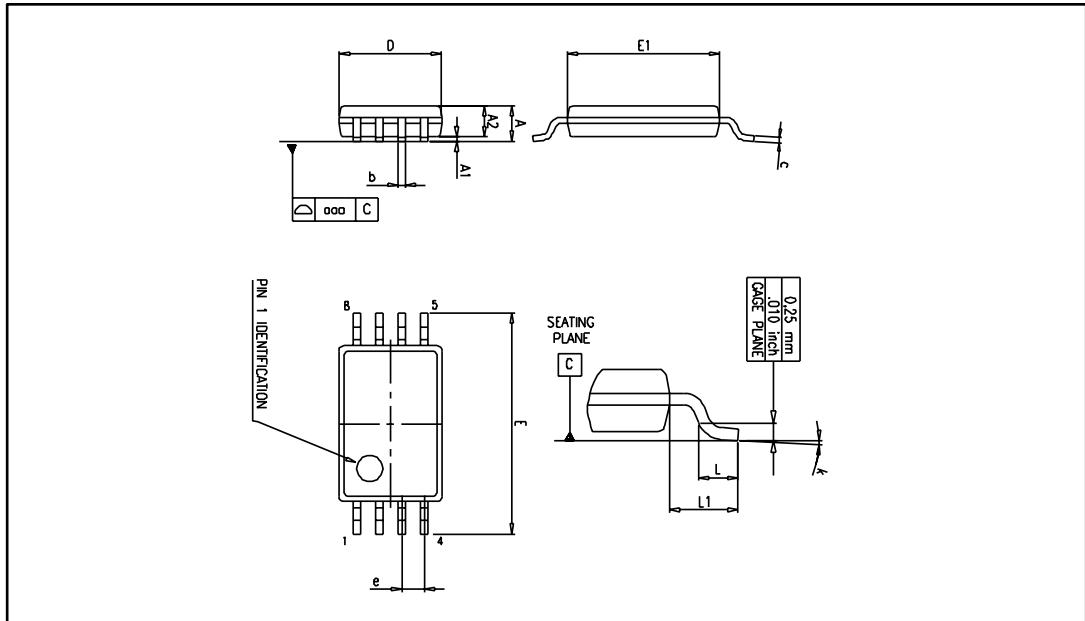

Table 8: TSSOP8 package mechanical data

| Symbol | Dimensions | | | | | |
|--------|-------------|------|------|--------|--------|-------|
| | Millimeters | | | Inches | | |
| | Min. | Typ. | Max. | Min. | Typ. | Max. |
| A | | | 1.2 | | | 0.047 |
| A1 | 0.05 | | 0.15 | 0.002 | | 0.006 |
| A2 | 0.80 | 1.00 | 1.05 | 0.031 | 0.039 | 0.041 |
| b | 0.19 | | 0.30 | 0.007 | | 0.012 |
| c | 0.09 | | 0.20 | 0.004 | | 0.008 |
| D | 2.90 | 3.00 | 3.10 | 0.114 | 0.118 | 0.122 |
| E | 6.20 | 6.40 | 6.60 | 0.244 | 0.252 | 0.260 |
| E1 | 4.30 | 4.40 | 4.50 | 0.169 | 0.173 | 0.177 |
| e | | 0.65 | | | 0.0256 | |
| k | 0° | | 8° | 0° | | 8° |
| L | 0.45 | 0.60 | 0.75 | 0.018 | 0.024 | 0.030 |
| L1 | | 1 | | | 0.039 | |
| aaa | | 0.1 | | | 0.004 | |

3.5 SO14 package information

Figure 23: SO14 package outline



Table 9: SO14 package mechanical data

| Symbol | Dimensions | | | | | |
|--------|-------------|------|------|--------|-------|-------|
| | Millimeters | | | Inches | | |
| | Min. | Typ. | Max. | Min. | Typ. | Max. |
| A | | | 1.75 | | | 0.068 |
| a1 | 0.1 | | 0.2 | 0.003 | | 0.007 |
| a2 | | | 1.65 | | | 0.064 |
| b | 0.35 | | 0.46 | 0.013 | | 0.018 |
| b1 | 0.19 | | 0.25 | 0.007 | | 0.010 |
| C | | 0.5 | | | 0.019 | |
| c1 | 45° (typ.) | | | | | |
| D | 8.55 | | 8.75 | 0.336 | | 0.344 |
| E | 5.8 | | 6.2 | 0.228 | | 0.244 |
| e | | 1.27 | | | 0.050 | |
| e3 | | 7.62 | | | 0.300 | |
| F | 3.8 | | 4.0 | 0.149 | | 0.157 |
| G | 4.6 | | 5.3 | 0.181 | | 0.208 |
| L | 0.5 | | 1.27 | 0.019 | | 0.050 |
| M | | | 0.68 | | | 0.026 |
| S | 8° (max.) | | | | | |

3.6 TSSOP14 package information

Figure 24: TSSOP14 package outline



Table 10: TSSOP14 package mechanical data

| Symbol | Dimensions | | | | | |
|--------|-------------|----------|------|--------|------------|--------|
| | Millimeters | | | Inches | | |
| | Min. | Typ. | Max. | Min. | Typ. | Max. |
| A | | | 1.2 | | | 0.047 |
| A1 | 0.05 | | 0.15 | 0.002 | 0.004 | 0.006 |
| A2 | 0.8 | 1 | 1.05 | 0.031 | 0.039 | 0.041 |
| b | 0.19 | | 0.30 | 0.007 | | 0.012 |
| c | 0.09 | | 0.20 | 0.004 | | 0.0089 |
| D | 4.9 | 5 | 5.1 | 0.193 | 0.197 | 0.201 |
| E | 6.2 | 6.4 | 6.6 | 0.244 | 0.252 | 0.260 |
| E1 | 4.3 | 4.4 | 4.48 | 0.169 | 0.173 | 0.176 |
| e | | 0.65 BSC | | | 0.0256 BSC | |
| K | 0° | | 8° | 0° | | 8° |
| L1 | 0.45 | 0.60 | 0.75 | 0.018 | 0.024 | 0.030 |

4 Ordering information

Table 11: Order codes

| Order code | Temperature range | Package | Packaging | Marking | |
|-----------------------------|--|------------------------------------|---------------|---|--------|
| TSV321RILT | -40 °C to +125 °C | SOT23-5 | Tape and reel | K174 | |
| TSV321RAILT | | | | K178 | |
| TSV321RIYLT ⁽¹⁾ | | | | SOT23-5 (automotive grade level) | K179 |
| TSV321RAIYLT ⁽¹⁾ | | | | | K187 |
| TSV321IDT | | SO8 | | V321ID | |
| TSV321AIDT | | | | V321AI | |
| TSV358IDT | | | | V358ID | |
| TSV358AIDT | | | | V358AID | |
| TSV358IYDT ⁽¹⁾ | | | | SO8 (automotive grade level) | V358YD |
| TSV358AIYDT ⁽¹⁾ | | | | | V358AY |
| TSV358IPT | | | | TSSOP8 (thin shrink outline package) | V358I |
| TSV358AIPT | | | | | V358A |
| TSV358IYPT ⁽¹⁾ | | TSSOP8 (automotive grade level) | | V358Y | |
| TSV358AIYPT ⁽¹⁾ | | | | V58AY | |
| TSV358IST | | MiniSO8 | | K175 | |
| TSV358AIST | | | | K184 | |
| TSV324IDT | | SO14 | | V324ID | |
| TSV324AIDT | | | | V324AI | |
| TSV324IYDT ⁽¹⁾ | | SO14 (automotive grade level) | | V324YD | |
| TSV324AIYDT ⁽¹⁾ | | | | V324AY | |
| TSV324IPT | TSSOP14 (thin shrink outline package) | V324IP | | | |
| TSV324AIPT | | V324A | | | |
| TSV324AIYPT ⁽¹⁾ | TSSOP14 (automotive grade level) | V324AY | | | |
| TSV324IYPT ⁽¹⁾ | | V324Y | | | |

Notes:

⁽¹⁾ Qualified and characterized according to AEC Q100 and Q003 or equivalent, advanced screening according to AEC Q001 and Q 002 or equivalent.

5 Revision history

Table 12: Document revision history

| Date | Revision | Changes |
|-------------|----------|--|
| 2-Aug-2005 | 1 | First release - Products in full production. |
| 20-Sep-2005 | 2 | Addition of TS321A/TS324A/TS358A data in tables in Section 2: "Electrical characteristics" . Minor formatting and grammatical changes. |
| 7-Dec-2005 | 3 | Missing PPAP references inserted see Section 4: "Ordering information" . |
| 28-Jun-2007 | 4 | Correction made on output drive capability, 80mA in description on cover page. SVR measurement conditions inserted in electrical characteristics tables. Offset voltage limit in temperature added in Section 2: "Electrical characteristics" . Correction made on Input Bias Current typical value in Section 2: "Electrical characteristics" . Captions of electrical characteristics figures updated. Automotive grade order codes added to Section 4: "Ordering information" . |
| 21-Feb-2008 | 5 | Corrected SO-14 R _{thja} value to 105 °C/W. Updated presentation of package information. Corrected footnote for automotive grade order codes in order code table. |
| 13-Sep-2012 | 6 | Updated Features (added SO-8, SO-14, TSSOP8, TSSOP14, and MiniSO-8 package). Updated "Pin connection" figure on page 1 (removed part numbers). Removed TSV321ID, TSV321AID, TSV321IYDT, TSV358ID, TSV358AID, TSV324ID, TSV324AID, TSV321IYD, TSV358IYD, TSV358AIYD, TSV321IYD, TSV324IYD, and TSV324AIYD order code from Table 11: "Order codes" . Qualified status of TSV324AIYPT, TSV324IYPT, TSV324IYDT, TSV324AIYDT, TSV358IYDT, TSV321RIYLT, TSV321RAIYLT, and TSV358AIYDT order code in Table 11: "Order codes" . Updated ECOPACK text in Section 3: "Package information" . Minor corrections throughout document. |
| 16-Aug-2013 | 7 | Updated Features Added Related products Table 3 and Table 4 : replaced ΔV_{io} with $\Delta V_{io}/\Delta T$ Table 11: "Order codes" : order code TSV321IDT renamed TSV321AIDT, added order code TSV358AIDT, updated footnote associated with order codes TSV358IYPT and TSV358AIYPT. |

Revision history**TSV321, TSV358, TSV324, TSV321A, TSV358A,
TSV324A,**

| Date | Revision | Changes |
|-------------|----------|--|
| 27-Jun-2014 | 8 | Added part numbers TSV321A, TSV358A, and TSV324A. <i>Table 6: "SO8 package mechanical data"</i> : added L1 dimensions <i>Table 11: "Order codes"</i> : removed "tube" from all packaging Updated disclaimer |

Please Read Carefully

Information in this document is provided solely in connection with ST products. STMicroelectronics NV and its subsidiaries ("ST") reserve the right to make changes, corrections, modifications or improvements, to this document, and the products and services described herein at any time, without notice.

All ST products are sold pursuant to ST's terms and conditions of sale.

Purchasers are solely responsible for the choice, selection and use of the ST products and services described herein, and ST assumes no liability whatsoever relating to the choice, selection or use of the ST products and services described herein.

No license, express or implied, by estoppel or otherwise, to any intellectual property rights is granted under this document. If any part of this document refers to any third party products or services it shall not be deemed a license grant by ST for the use of such third party products or services, or any intellectual property contained therein or considered as a warranty covering the use in any manner whatsoever of such third party products or services or any intellectual property contained therein.

UNLESS OTHERWISE SET FORTH IN ST'S TERMS AND CONDITIONS OF SALE ST DISCLAIMS ANY EXPRESS OR IMPLIED WARRANTY WITH RESPECT TO THE USE AND/OR SALE OF ST PRODUCTS INCLUDING WITHOUT LIMITATION IMPLIED WARRANTIES OF MERCHANTABILITY, FITNESS FOR A PARTICULAR PURPOSE (AND THEIR EQUIVALENTS UNDER THE LAWS OF ANY JURISDICTION), OR INFRINGEMENT OF ANY PATENT, COPYRIGHT OR OTHER INTELLECTUAL PROPERTY RIGHT.

ST PRODUCTS ARE NOT DESIGNED OR AUTHORIZED FOR USE IN: (A) SAFETY CRITICAL APPLICATIONS SUCH AS LIFE SUPPORTING, ACTIVE IMPLANTED DEVICES OR SYSTEMS WITH PRODUCT FUNCTIONAL SAFETY REQUIREMENTS; (B) AERONAUTIC APPLICATIONS; (C) AUTOMOTIVE APPLICATIONS OR ENVIRONMENTS, AND/OR (D) AEROSPACE APPLICATIONS OR ENVIRONMENTS. WHERE ST PRODUCTS ARE NOT DESIGNED FOR SUCH USE, THE PURCHASER SHALL USE PRODUCTS AT PURCHASER'S SOLE RISK, EVEN IF ST HAS BEEN INFORMED IN WRITING OF SUCH USAGE, UNLESS A PRODUCT IS EXPRESSLY DESIGNATED BY ST AS BEING INTENDED FOR "AUTOMOTIVE, AUTOMOTIVE SAFETY OR MEDICAL" INDUSTRY DOMAINS ACCORDING TO ST PRODUCT DESIGN SPECIFICATIONS. PRODUCTS FORMALLY ESCC, QML OR JAN QUALIFIED ARE DEEMED SUITABLE FOR USE IN AEROSPACE BY THE CORRESPONDING GOVERNMENTAL AGENCY.

Resale of ST products with provisions different from the statements and/or technical features set forth in this document shall immediately void any warranty granted by ST for the ST product or service described herein and shall not create or extend in any manner whatsoever, any liability of ST.

ST and the ST logo are trademarks or registered trademarks of ST in various countries.

Information in this document supersedes and replaces all information previously supplied.

The ST logo is a registered trademark of STMicroelectronics. All other names are the property of their respective owners.

© 2014 STMicroelectronics - All rights reserved

STMicroelectronics group of companies

Australia - Belgium - Brazil - Canada - China - Czech Republic - Finland - France - Germany - Hong Kong - India - Israel - Italy - Japan - Malaysia - Malta - Morocco - Philippines - Singapore - Spain - Sweden - Switzerland - United Kingdom - United States of America

www.st.com

Компания «Life Electronics» занимается поставками электронных компонентов импортного и отечественного производства от производителей и со складов крупных дистрибьюторов Европы, Америки и Азии.

С конца 2013 года компания активно расширяет линейку поставок компонентов по направлению коаксиальный кабель, кварцевые генераторы и конденсаторы (керамические, пленочные, электролитические), за счёт заключения дистрибьюторских договоров

Мы предлагаем:

- Конкурентоспособные цены и скидки постоянным клиентам.
- Специальные условия для постоянных клиентов.
- Подбор аналогов.
- Поставку компонентов в любых объемах, удовлетворяющих вашим потребностям.
- Приемлемые сроки поставки, возможна ускоренная поставка.
- Доставку товара в любую точку России и стран СНГ.
- Комплексную поставку.
- Работу по проектам и поставку образцов.
- Формирование склада под заказчика.
- Сертификаты соответствия на поставляемую продукцию (по желанию клиента).
- Тестирование поставляемой продукции.
- Поставку компонентов, требующих военную и космическую приемку.
- Входной контроль качества.
- Наличие сертификата ISO.

В составе нашей компании организован Конструкторский отдел, призванный помогать разработчикам, и инженерам.

Конструкторский отдел помогает осуществить:

- Регистрацию проекта у производителя компонентов.
- Техническую поддержку проекта.
- Защиту от снятия компонента с производства.
- Оценку стоимости проекта по компонентам.
- Изготовление тестовой платы монтаж и пусконаладочные работы.



Тел: +7 (812) 336 43 04 (многоканальный)

Email: org@lifeelectronics.ru