

SERIES: SMI6 | DESCRIPTION: AC-DC POWER SUPPLY
FEATURES

- DoE Level VI, CoC Tier 2 efficiency
- up to 6 W power
- interchangeable AC blades
- universal input (90~264 Vac)
- single regulated output from 5~15 Vdc
- over voltage and short circuit protections
- UL/cUL, GS, RCM, CCC, PSE safety approvals
- custom designs available



MODEL	output voltage	output current max	output power max	ripple and noise ¹ max	efficiency level ²
	(Vdc)	(A)	(W)	(mVp-p)	
SMI6-5	5	1.2	6	150	VI
SMI6-5.95	5.95	1	6	150	VI
SMI6-9	9	0.67	6	150	VI
SMI6-12	12	0.5	6	200	VI
SMI6-15	15	0.4	6	200	VI

Notes: 1. At full load, 100-240 Vac input, 20 MHz bandwidth oscilloscope, output terminated with 0.1 μ F ceramic and 10 μ F electrolytic capacitors.
2. CoC Tier 2 compliant

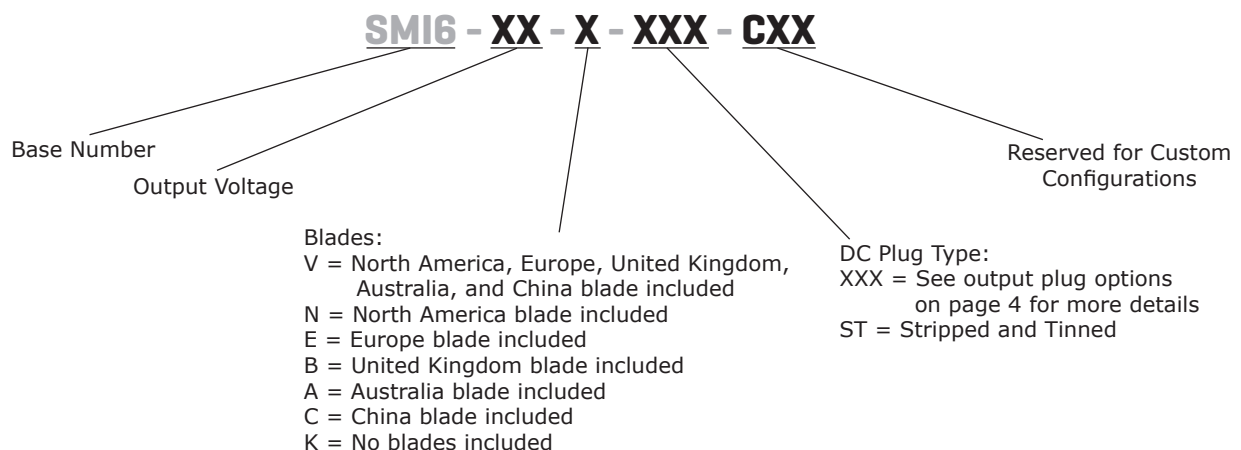
PART NUMBER KEY

INPUT

parameter	conditions/description	min	typ	max	units
voltage		90		264	Vac
frequency		47		63	Hz
current				0.3	A
leakage current				0.25	mA
no load power consumption				0.075	W

OUTPUT

parameter	conditions/description	min	typ	max	units
line regulation			±1		%
load regulation	5 Vdc output model all other models		±6 ±5		% %

PROTECTIONS

parameter	conditions/description	min	typ	max	units
over voltage protection	output shut down, auto recovery				
short circuit protection	output shut down, auto recovery				

SAFETY & COMPLIANCE

parameter	conditions/description	min	typ	max	units
isolation voltage	input to output at 10 mA for 1 minute		3,000 4,242		Vac Vdc
isolation resistance	input to output at 500 Vdc	100			MΩ
safety approvals	UL/cUL, GS, RCM, CCC, PSE				
EMI/EMC	FCC Part 15B Class B, CE				
RoHS	yes				

ENVIRONMENTAL

parameter	conditions/description	min	typ	max	units
operating temperature		0		40	°C
storage temperature		-10		70	°C
operating humidity	non-condensing	20		80	%
storage humidity	non-condensing	10		90	%

MECHANICAL

parameter	conditions/description	min	typ	max	units
dimensions	64 x 40.5 x 30				mm
inlet plug	interchangeable blades (North America, Europe, UK, Australia, China)				
weight	5.95 Vdc model (without interchangeable blades)		69		g
	all other models (without interchangeable blades)		68.5		g

MECHANICAL DRAWING

units: mm
tolerance: ±1 mm

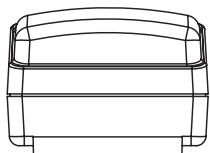
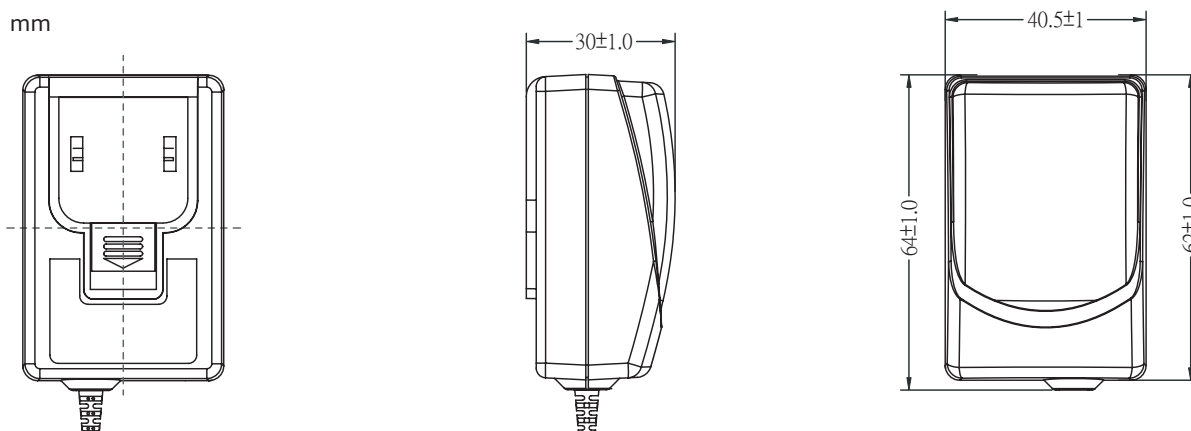

INTERCHANGEABLE BLADES					
BLADE DESIGNATOR	N	E	B	A	C
REGION	North America	Europe	UK	Australia	China
BLADE ACCESSORY	SMI-US-1	SMI-EU-1	SMI-UK-1	SMI-AU-1	SMI-CN-1
BLADE					

DC CORD

units: mm

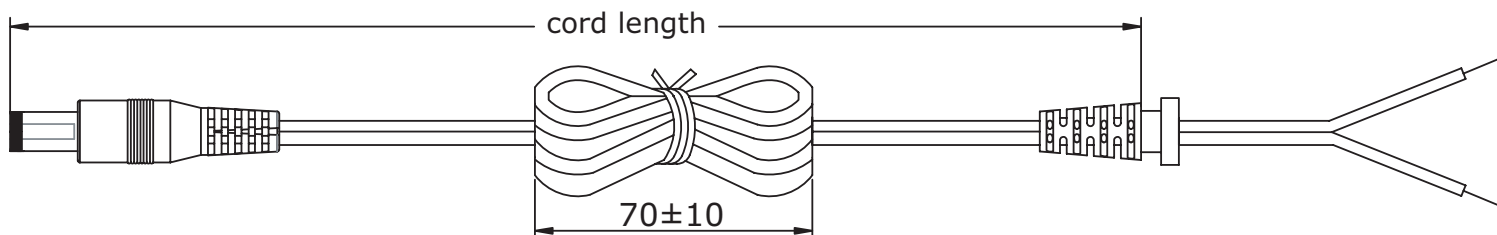
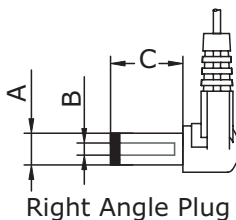
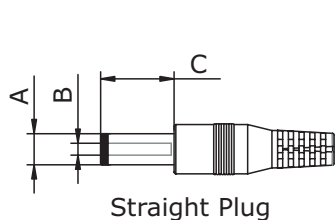

Table 1

MODEL NO.	CABLE	CORD LENGTH
SMI6-5	UL2468, 20 AWG	1,530 mm ±100
SMI6-5.95	UL2468, 20 AWG	1,530 mm ±100
SMI6-9	UL2468, 22 AWG	1,530 mm ±100
SMI6-12	UL2468, 22 AWG	1,530 mm ±100
SMI6-15	UL2468, 22 AWG	1,530 mm ±100

OUTPUT PLUG OPTIONS

Standard DC Plug



Size	A	B	C	Unit
5	5.5	2.1	9.5	mm
6	5.5	2.5	9.5	mm
7	3.5	1.35	9.5	mm
8	3.8	1.35	9.5	mm
9	3.8	1.05	9.5	mm

Locking DC Plug

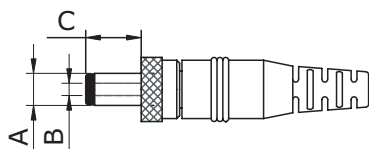

Size	A	B	C	Unit
10	5.5	2.1	9.5	mm
11	5.5	2.5	9.5	mm

EIAJ DC Plug

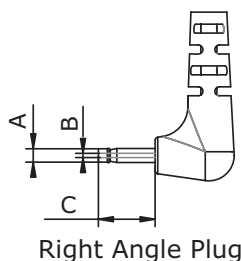
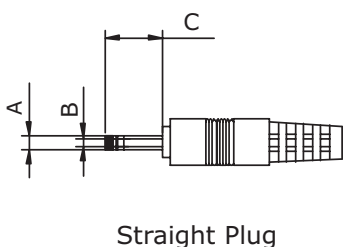

Size	EIAJ	A	B	C	Unit
12	EIAJ-1	2.35	0.7	9.5	mm
13	EIAJ-2	4.0	1.7	9.5	mm
14	EIAJ-3	4.75	1.7	9.5	mm

Stripped and Tinned

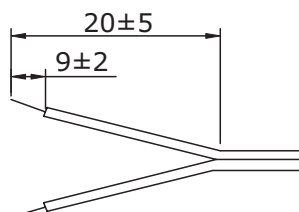

DC Plug Type

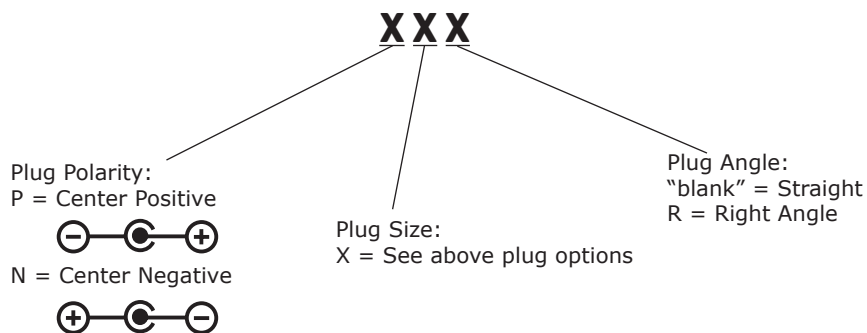

*Contact CUI for additional plug options

REVISION HISTORY

rev.	description	date
1.0	initial release	07/01/2015
1.01	updated datasheet	02/08/2016
1.02	updated datasheet	09/14/2016
1.03	Australia blade housing changed, and blade orientation rotated 90 degrees	10/02/2018

The revision history provided is for informational purposes only and is believed to be accurate.



Headquarters
20050 SW 112th Ave.
Tualatin, OR 97062
800.275.4899

Fax 503.612.2383
cui.com
techsupport@cui.com

This device complies with part 15 of the FCC Rules. Operation is subject to the following two conditions:

- (1) This device may not cause harmful interference, and
- (2) this device must accept any interference received, including interference that may cause undesired operation.

CUI offers a one (1) year limited warranty. Complete warranty information is listed on our website.

CUI reserves the right to make changes to the product at any time without notice. Information provided by CUI is believed to be accurate and reliable. However, no responsibility is assumed by CUI for its use, nor for any infringements of patents or other rights of third parties which may result from its use.

CUI products are not authorized or warranted for use as critical components in equipment that requires an extremely high level of reliability. A critical component is any component of a life support device or system whose failure to perform can be reasonably expected to cause the failure of the life support device or system, or to affect its safety or effectiveness.

Компания «Life Electronics» занимается поставками электронных компонентов импортного и отечественного производства от производителей и со складов крупных дистрибьюторов Европы, Америки и Азии.

С конца 2013 года компания активно расширяет линейку поставок компонентов по направлению коаксиальный кабель, кварцевые генераторы и конденсаторы (керамические, пленочные, электролитические), за счёт заключения дистрибьюторских договоров

Мы предлагаем:

- Конкуренспособные цены и скидки постоянным клиентам.
- Специальные условия для постоянных клиентов.
- Подбор аналогов.
- Поставку компонентов в любых объемах, удовлетворяющих вашим потребностям.
- Приемлемые сроки поставки, возможна ускоренная поставка.
- Доставку товара в любую точку России и стран СНГ.
- Комплексную поставку.
- Работу по проектам и поставку образцов.
- Формирование склада под заказчика.
- Сертификаты соответствия на поставляемую продукцию (по желанию клиента).
- Тестирование поставляемой продукции.
- Поставку компонентов, требующих военную и космическую приемку.
- Входной контроль качества.
- Наличие сертификата ISO.

В составе нашей компании организован Конструкторский отдел, призванный помогать разработчикам, и инженерам.

Конструкторский отдел помогает осуществить:

- Регистрацию проекта у производителя компонентов.
- Техническую поддержку проекта.
- Защиту от снятия компонента с производства.
- Оценку стоимости проекта по компонентам.
- Изготовление тестовой платы монтаж и пусконаладочные работы.



Тел: +7 (812) 336 43 04 (многоканальный)

Email: org@lifeelectronics.ru