

## High Voltage High Current Feed-Through Terminal Blocks

---

The new High Voltage Generation of high current feed-through terminal blocks is specially designed for the requirements of drive technology and power electronics.

In addition to the already familiar simple assembly, the outstanding feature of these terminal blocks is a high nominal voltage of 1000 V. For the conductor cross section range up to 10 mm<sup>2</sup>, there are the horizontal feed-through terminal blocks, HDFK 10-HV and the vertical version, HDFKV 10-HV.

The HDFKV 10-TWIN-HV with a conductor connection on both sides is used to loop through intermediate circuit voltages.

In addition to this, the HV range is rounded off by the molded variant.

The HDFK...-VP-HV terminal blocks are specially designed for the requirements of potted devices, such as filter modules, for example. They are an ideal supplement to the HDFK range for the cross section range of up to 10 mm<sup>2</sup>.

The external parts of the molded high current feed-through terminal blocks is identical to those of the standard HV versions.

On the inside of the device, however, there is a sealing plate as well as a sponge rubber seal that prevents the molding compound from leaking out. The connection here is soldered.



# High Current Feed-Through Terminal Blocks HDFK 10-HV

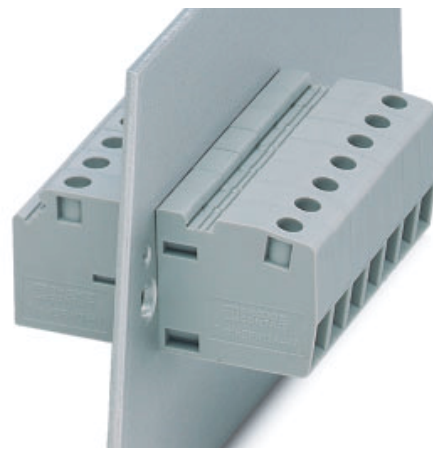

(IEC) [mm <sup>2</sup> ]	rigid solid	flexible stranded	AWG	I [A]	U [V]
Connection data	0.5-16	0.5-10	20-6	76	1000



## Technical data

**Feed-through terminal block**, for 1 - 4 mm thick housing panels, with internal and external screw connection

(1) **Insertion bridge**<sup>1)</sup>, fully insul., 2-pos. fully insulated, 3-pos. divisible, fully insulated, 10-pos.

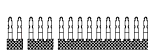

(2) **Screwdriver**, for actuating the tension spring

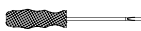

(3) **Zack strip**, 10-section, white

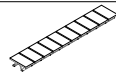

### Dimensions

#### Technical data in accordance with IEC/ DIN VDE

Max. cross section with insertion bridge (solid/stranded)	[mm <sup>2</sup> ]
Rated surge voltage / contamination class	[kV] / -
Surge voltage category / insulation material group	- / -

#### Connection capacity

Stranded with ferrule without / with plastic sleeve	[mm <sup>2</sup> ]
-----------------------------------------------------	--------------------

#### Multi-conductor connection (2 cond. with same cross section)

Solid / Stranded	[mm <sup>2</sup> ]
Stranded with ferrule without plastic sleeve	[mm <sup>2</sup> ]
Stranded with TWIN ferrule with plastic sleeve	[mm <sup>2</sup> ]

**Stripping length** [mm]

#### Internal cylindrical gauge (IEC 60 947-1)

**Terminal sleeve: Thread / torque** - / [Nm]

#### Insulating material

Inflammability class in acc. with UL 94

#### Approval data (UL and CSA/CUL)

Nominal voltage / current / conductor sizes	UL: [V] / [A] / AWG
	CSA/CUL: [V] / [A] / AWG

<sup>1)</sup> Finger-safe protection is not guaranteed when using the insertion bridge externally.

#### Note:

With the HDFK and HDFKV, the terminal space must be completely open when joining both terminal block halves.

The HDFK 10-HV can also be connected if turned by 180°.

Type	Order No.	Pcs. Pkt.
HDFK 10-HV	07 09 86 4	50
EB 2-10	I <sub>max</sub> : 70 A	100
EB 3-10		10
EB 10-10		10
SZS 1,0 x 4,0	12 05 06 6	10
ZB 10:UNPRINTED	10 53 00 1	10

see dimensional drawing

10 / 10
6 / 3
III / I
0.5 - 10 / 0.5 - 10
0.5 - 4 / 0.5 - 4
0.5 - 2.5
0.5 - 6
11
B 6
M 4 / 1.5 - 1.8
PA
V0
600 / 65 / 24 - 6
600 / 65 / 22 - 6

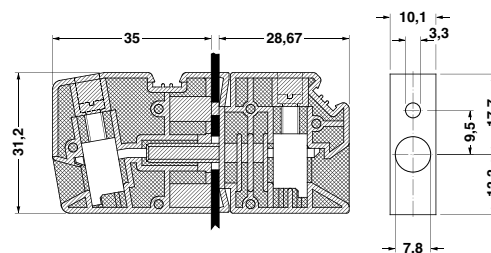

# High Current Feed-Through Terminal Blocks HDFKV 10-HV



(IEC) [mm <sup>2</sup> ]	rigid solid	flexible stranded	AWG	I [A]	U [V]
Connection data	0.5-16	0.5-10	20-6	76	1000

## Technical data

**Feed-through terminal block**, for 1 - 4 mm thick housing panels, with internal and external screw connection

(1) **Insertion bridge**<sup>1)</sup>, fully insul., 2-pos. fully insulated, 3-pos. divisible, fully insulated, 10-pos.

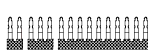

(2) **Screwdriver**, for actuating the tension spring

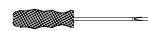

(3) **Zack strip**, 10-section, white

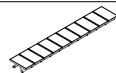

## Dimensions

### Technical data in accordance with IEC/ DIN VDE

Max. cross section with insertion bridge (solid/stranded)	[mm <sup>2</sup> ]	10 / 10
Rated surge voltage / contamination class	[kV] / -	6 / 3
Surge voltage category / insulation material group	- / -	III / I

### Connection capacity

Stranded with ferrule without / with plastic sleeve	[mm <sup>2</sup> ]	0.5 - 10 / 0.5 - 10
-----------------------------------------------------	--------------------	---------------------

### Multi-conductor connection (2 cond. with same cross section)

Solid / Stranded	[mm <sup>2</sup> ]	0.5 - 4 / 0.5 - 4
Stranded with ferrule without plastic sleeve	[mm <sup>2</sup> ]	0.5 - 2.5
Stranded with TWIN ferrule with plastic sleeve	[mm <sup>2</sup> ]	0.5 - 6

**Stripping length** [mm] 11

**Internal cylindrical gauge (IEC 60 947-1)** B 6

**Terminal sleeve: Thread / torque** M 4 / 1.5 - 1.8

### Insulating material

Inflammability class in acc. with UL 94 PA

### Approval data (UL and CSA/CUL)

Nominal voltage / current / conductor sizes UL/CUL: [V] / [A] / AWG 600 / 65 / 24 - 6

<sup>1)</sup> Finger-safe protection is not guaranteed when using the insertion bridge externally.

### Note:

With the HDFK and HDFKV, the terminal space must be completely open when joining both terminal block halves.

Type	Order No.	Pcs. Pkt.
HDFKV 10-HV	07 17 23 8	50
EB 2-10	I <sub>max</sub> : 70 A	100
EB 3-10		10
EB 10-10		10
SZS 1,0 x 4,0	12 05 06 6	10
ZB 10:UNPRINTED	10 53 00 1	10

see dimensional drawing

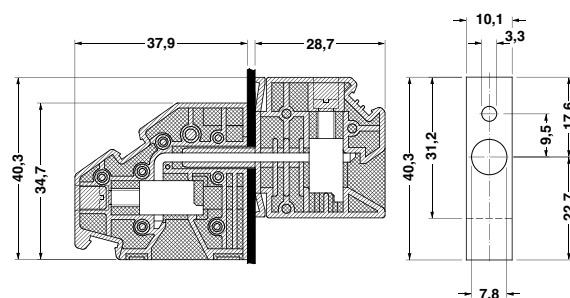

# High Current Feed-Through Terminal Blocks

## HDFKV 10-TWIN-HV

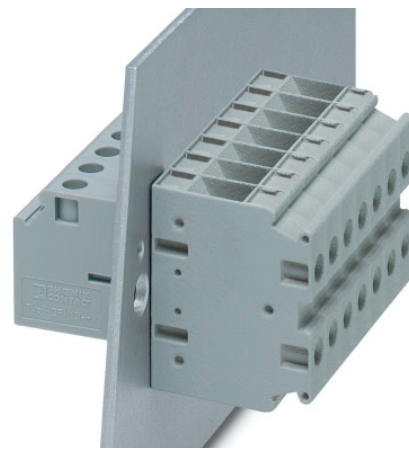

(IEC) [mm <sup>2</sup> ]	rigid solid	flexible stranded	AWG	I [A]	U [V]
Connection data	0.5-16	0.5-10	20-6	76*	1000

\* The max. load current must not be exceeded by the total current of all connected conductors.

### Technical data

**Feed-through terminal block**, with internal and external screw connection, for 1 - 4 mm thick housing panels, external for vertical conductor connection

(1) **Insertion bridge**<sup>1)</sup>, fully insul., 2-pos. fully insulated, 3-pos. divisible, fully insulated, 10-pos.

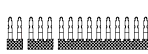

(2) **Screwdriver**, for actuating the tension spring

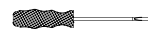

(3) **Zack strip**, 10-section, white

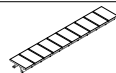

### Dimensions

#### Technical data in accordance with IEC/ DIN VDE

Max. cross section with insertion bridge (solid/stranded)	[mm <sup>2</sup> ]
Rated surge voltage / contamination class	[kV] / -
Surge voltage category / insulation material group	- / -

#### Connection capacity

Stranded with ferrule without / with plastic sleeve	[mm <sup>2</sup> ]
-----------------------------------------------------	--------------------

#### Multi-conductor connection (2 cond. with same cross section)

Solid / Stranded	[mm <sup>2</sup> ]
Stranded with ferrule without plastic sleeve	[mm <sup>2</sup> ]
Stranded with TWIN ferrule with plastic sleeve	[mm <sup>2</sup> ]

**Stripping length** [mm]

#### Internal cylindrical gauge (IEC 60 947-1)

**Terminal sleeve: Thread / torque** - / [Nm]

#### Insulating material

Inflammability class in acc. with UL 94

#### Approval data (UL and CSA/CUL)

Nominal voltage / current / conductor sizes UL/CUL: [V] / [A] / AWG

Type	Order No.	Pcs. Pkt.
<b>HDFKV 10-TWIN-HV</b>	<b>07 17 24 1</b>	<b>50</b>
<b>EB 2-10</b>	<b>02 03 15 3</b>	<b>100</b>
<b>EB 3-10</b>	<b>02 03 32 8</b>	<b>10</b>
<b>EB 10-10</b>	<b>02 03 13 7</b>	<b>10</b>
<b>SZS 1,0 x 4,0</b>	<b>12 05 06 6</b>	<b>10</b>
<b>ZB 10:UNPRINTED</b>	<b>10 53 00 1</b>	<b>10</b>

see dimensional drawing

	10 / 10
	6 / 3
	III / I
	0.5 - 10 / 0.5 - 10
	0.5 - 4 / 0.5 - 4
	0.5 - 2.5
	0.5 - 6
	11
	B 6
	M 4 / 1.5 - 1.8
	PA
	V0
	600 / 65 / 24 - 6

<sup>1)</sup> Finger-safe protection is not guaranteed when using the insertion bridge externally.

#### Note:

With the HDFK and HDFKV, the terminal space must be completely open when joining both terminal block halves.

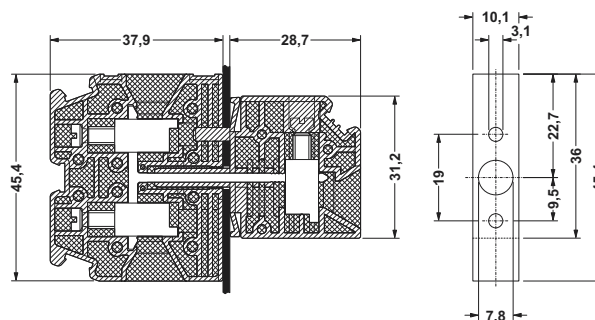

# High Current Feed-Through Terminal Blocks



## HDFK 10-VP-HV



(IEC) [mm <sup>2</sup> ]	rigid solid	flexible stranded	AWG	I [A]	U [V]
Connection data	0.5-16	0.5-10	20-6	76	1000

### Technical data

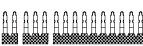
**Molded feed-through terminal block**, for 1 - 4 mm thick housing panels, with external screw connection, with solder connection and sealing plate inside

(1) **Insertion bridge**<sup>1)</sup>, fully insul., 2-pos.   
 fully insulated, 3-pos.   
 divisible, fully insulated, 10-pos. 

(2) **Screwdriver**, for actuating the tension spring 

(3) **Zack strip**, 10-section, white 

### Dimensions

#### Technical data in accordance with IEC/ DIN VDE

Max. cross section with insertion bridge (solid/stranded)	[mm <sup>2</sup> ]
Rated surge voltage / contamination class	[kV] / -
Surge voltage category / insulation material group	- / -

#### Connection capacity

Stranded with ferrule without / with plastic sleeve	[mm <sup>2</sup> ]
-----------------------------------------------------	--------------------

#### Multi-conductor connection (2 cond. with same cross section)

Solid / Stranded	[mm <sup>2</sup> ]
Stranded with ferrule without plastic sleeve	[mm <sup>2</sup> ]
Stranded with TWIN ferrule with plastic sleeve	[mm <sup>2</sup> ]

**Stripping length** [mm]

#### Internal cylindrical gauge (IEC 60 947-1)

**Terminal sleeve: Thread / torque** - / [Nm]

#### Insulating material

Inflammability class in acc. with UL 94

<sup>1)</sup> Finger-safe protection is not guaranteed when using the insertion bridge externally.

Type	Order No.	Pcs. Pkt.
<b>HDFK 10-VP-HV</b>	<b>07 17 39 3</b>	<b>50</b>
<b>EB 2-10</b>	$I_{max}$ : 70 A	<b>02 03 15 3</b>
<b>EB 3-10</b>	70 A	<b>02 03 32 8</b>
<b>EB 10-10</b>	70 A	<b>02 03 13 7</b>
<b>SZS 1,0 x 4,0</b>	<b>12 05 06 6</b>	<b>10</b>
<b>ZB 10:UNPRINTED</b>	<b>10 53 00 1</b>	<b>10</b>

see dimensional drawing

10 / 10
6 / 3
III / I
0.5 - 10 / 0.5 - 10
0.5 - 4 / 0.5 - 4
0.5 - 2.5
0.5 - 6
11
B 6
M 4 / 1.5 - 1.8
PA
V0

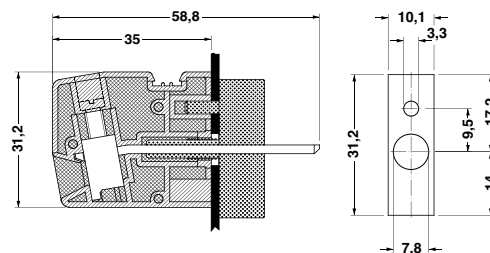

# High Current Feed-Through Terminal Blocks

## HDFKV 10-VP-HV



(IEC) [mm <sup>2</sup> ]	rigid solid	flexible stranded	AWG	I [A]	U [V]
Connection data	0.5-16	0.5-10	20-6	76	1000

### Technical data

**Molded Feed-through terminal block**, for 1 - 4 mm thick housing panels, with external screw connection, with solder connection and sealing plate inside

(1) **Insertion bridge**<sup>1)</sup>, fully insul., 2-pos. fully insulated, 3-pos. divisible, fully insulated, 10-pos.

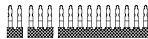

(2) **Screwdriver**, for actuating the tension spring



(3) **Zack strip**, 10-section, white

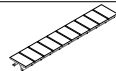

### Dimensions

#### Technical data in accordance with IEC/ DIN VDE

Max. cross section with insertion bridge (solid/stranded)	[mm <sup>2</sup> ]
Rated surge voltage / contamination class	[kV] / -
Surge voltage category / insulation material group	- / -

#### Connection capacity

Stranded with ferrule without / with plastic sleeve	[mm <sup>2</sup> ]
-----------------------------------------------------	--------------------

#### Multi-conductor connection (2 cond. with same cross section)

Solid / Stranded	[mm <sup>2</sup> ]
Stranded with ferrule without plastic sleeve	[mm <sup>2</sup> ]
Stranded with TWIN ferrule with plastic sleeve	[mm <sup>2</sup> ]

**Stripping length** [mm]

#### Internal cylindrical gauge (IEC 60 947-1)

**Terminal sleeve: Thread / torque** - / [Nm]

#### Insulating material

Inflammability class in acc. with UL 94

#### Approval data (UL and CSA/CUL)

Nominal voltage / current / conductor sizes UL/CUL: [V] / [A] / AWG

Type	Order No.	Pcs. Pkt.
HDFKV 10-VP-HV	07 17 25 4	50
EB 2-10	I <sub>max</sub> : 70 A	100
EB 3-10		10
EB 10-10		10
SZS 1,0 x 4,0	12 05 06 6	10
ZB 10:UNPRINTED	10 53 00 1	10

see dimensional drawing

10 / 10
6 / 3
III / I
0.5 - 10 / 0.5 - 10
0.5 - 4 / 0.5 - 4
0.5 - 2.5
0.5 - 6
11
B 6
M 4 / 1.5 - 1.8
PA
V0
600 / 65 / 24 - 6

<sup>1)</sup> Finger-safe protection is not guaranteed when using the insertion bridge externally.

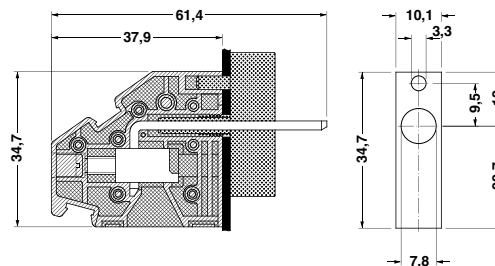

Компания «Life Electronics» занимается поставками электронных компонентов импортного и отечественного производства от производителей и со складов крупных дистрибьюторов Европы, Америки и Азии.

С конца 2013 года компания активно расширяет линейку поставок компонентов по направлению коаксиальный кабель, кварцевые генераторы и конденсаторы (керамические, пленочные, электролитические), за счёт заключения дистрибьюторских договоров

Мы предлагаем:

- Конкурентоспособные цены и скидки постоянным клиентам.
- Специальные условия для постоянных клиентов.
- Подбор аналогов.
- Поставку компонентов в любых объемах, удовлетворяющих вашим потребностям.
- Приемлемые сроки поставки, возможна ускоренная поставка.
- Доставку товара в любую точку России и стран СНГ.
- Комплексную поставку.
- Работу по проектам и поставку образцов.
- Формирование склада под заказчика.
- Сертификаты соответствия на поставляемую продукцию (по желанию клиента).
- Тестирование поставляемой продукции.
- Поставку компонентов, требующих военную и космическую приемку.
- Входной контроль качества.
- Наличие сертификата ISO.

В составе нашей компании организован Конструкторский отдел, призванный помогать разработчикам, и инженерам.

Конструкторский отдел помогает осуществить:

- Регистрацию проекта у производителя компонентов.
- Техническую поддержку проекта.
- Защиту от снятия компонента с производства.
- Оценку стоимости проекта по компонентам.
- Изготовление тестовой платы монтаж и пусконаладочные работы.



Тел: +7 (812) 336 43 04 (многоканальный)

Email: [org@lifeelectronics.ru](mailto:org@lifeelectronics.ru)