

# Series 03

## Characteristics

The robust and compact Series 03 is especially suited for:

- Flush design

The large rectangular design (24x48mm) provides the option for dual illumination in addition to the "XL" illuminated surface.

## Functions

The Series 03 incorporates the following functions:

- Indicator
- Pushbutton
- Illuminated pushbutton
- Keylock switch
- Buzzer

## Market segments

The EAO Series 03 is especially suited for applications in the segments:

- Ship building
- Panel building

Please refer to the EAO website to obtain detailed information regarding this series [www.products.eao.com](http://www.products.eao.com)  
Configure a product to your exact needs and request a quotation.





**Overview****Flush design**

Indicator	4
Buzzer	5
Pushbutton	6
Illuminated pushbutton	8
Keylock switch	10

**Accessories** 12**Technical data** 26**Marking** 28**Application guidelines** 29**Index** 30

# 03 Flush design

## Indicator, IP 40



Product can differ from the current configuration.



Dimensions [mm]

### Additional Information

- For front dimension 24 x 48 mm
- For LED element fitting information see «Application guidelines»
- Has two independent lamp bases
- Light barrier ordered separately



Mounting cut-outs [mm]

### Equipment consisting of (schematic overview)



Each Part Number listed below includes all the black components shown in the 3D-drawing.

*To obtain a complete unit, please select the red components from the pages shown.*

Terminal	Part No.	Wiring diagram	Weight
 <p><b>Indicator actuator</b></p>	<b>03-021.001</b>	1	0.045 kg



## Buzzer, IP 40

### Equipment consisting of (schematic overview)



Dimensions [mm]



Product can differ from the current configuration.

Each Part Number listed below includes all the black components shown in the 3D-drawing.

To obtain a complete unit, please select the red components from the pages shown.



Mounting cut-outs [mm]

### Additional Information

- For front dimension 24 x 48 mm
- Further information see «Technical data»

Operating voltage	Front cap	Terminal	Part No.	Wiring diagram	Weight
 <p><b>Buzzer</b></p>					
10 ... 55 VAC, 10 ... 75 VDC	Plastic black	Screw	<b>03-810.001</b>	1	0.060 kg

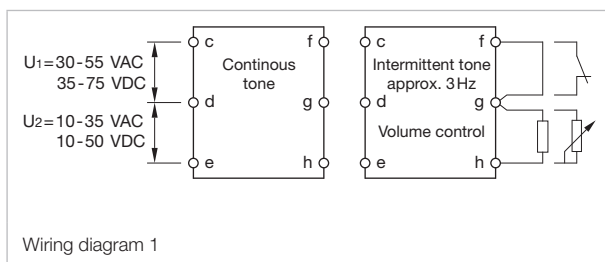

# 03 Flush design

## Pushbutton single-headed, IP 40



Product can differ from the current configuration.



Dimensions [mm]

### Additional Information

- For front dimension 24 x 48 mm



Mounting cut-outs [mm]

### Equipment consisting of (schematic overview)



Each Part Number listed below includes all the black components shown in the 3D-drawing.

To obtain a complete unit, please select the red components from the pages shown.

Contacts	Switching action	Terminal	Part No.	Wiring diagram	Weight
 <b>Pushbutton actuator single-headed</b>					
1 C	B	Screw	<b>03-611.011</b>	1	0.055 kg
	C	Screw	<b>03-613.011</b>	2	0.055 kg
2 C	B	Screw	<b>03-612.011</b>	3	0.065 kg
	C	Screw	<b>03-614.011</b>	4	0.065 kg
	B - C	Screw	<b>03-615.011</b>	5	0.065 kg

Contacts: C = Changeover

Switching action: B = Momentary, C = Maintained



## Pushbutton actuator double-headed, IP 40

**Equipment consisting of (schematic overview)**

-  **Front bezel** Seite 17
-  **Lens** Seite 13
-  **Actuator**
-  **Fixing sleeve**

Each Part Number listed below includes all the black components shown in the 3D-drawing.

To obtain a complete unit, please select the red components from the pages shown.

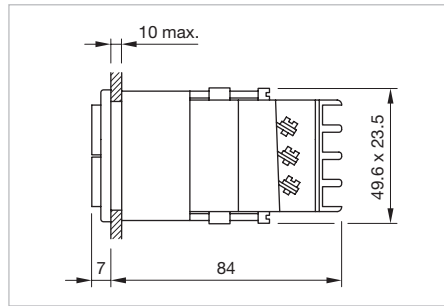

Dimensions [mm]



Product can differ from the current configuration.

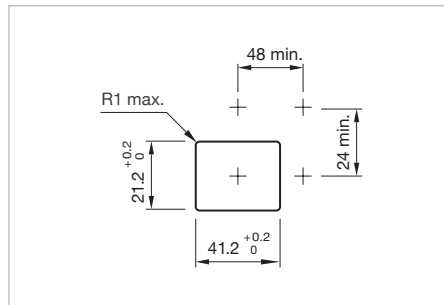

Mounting cut-outs [mm]

### Additional Information

- For front dimension 24 x 48 mm
- Has independent changeover

Contacts	Switching action	Terminal	Part No.	Wiring diagram	Weight
	B	Screw	<b>03-621.011</b>	1	0.065 kg
	C	Screw	<b>03-622.011</b>	2	0.065 kg
	B - C	Screw	<b>03-623.011</b>	3	0.065 kg

Contacts: C = Changeover  
Switching action: B = Momentary, C = Maintained

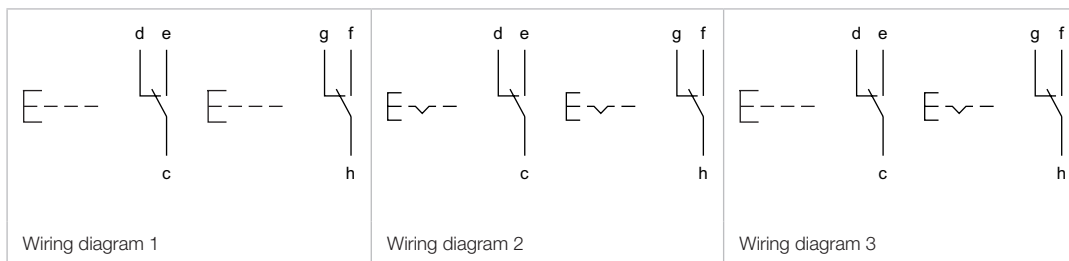

# 03 Flush design

## Illuminated pushbutton single headed, IP 40



Product can differ from the current configuration.



Dimensions [mm]

### Additional Information

- For front dimension 24 x 48 mm
- For LED element fitting information see «Application guidelines»
- Has two independent lamp bases
- Light barrier ordered separately



Mounting cut-outs [mm]

### Equipment consisting of (schematic overview)



Each Part Number listed below includes all the black components shown in the 3D-drawing.

To obtain a complete unit, please select the red components from the pages shown.

Contacts	Switching action	Terminal	Part No.	Wiring diagram	Weight
 <b>Illuminated pushbutton actuator single-headed</b>					
1 C	B	Screw	<b>03-616.011</b>	1	0.070 kg
	C	Screw	<b>03-618.011</b>	2	0.070 kg
2 C	B	Screw	<b>03-617.011</b>	3	0.075 kg
	C	Screw	<b>03-619.011</b>	4	0.075 kg
	B - C	Screw	<b>03-620.011</b>	5	0.075 kg

Contacts: C = Changeover  
Switching action: B = Momentary, C = Maintained





**Illuminated pushbutton double-headed, IP 40**

**Equipment consisting of (schematic overview)**

-  **Front bezel** Seite 17
-  **Lens** Seite 13
-  **LED** Seite 22
-  **Actuator**
-  **Fixing sleeve**



Dimensions [mm]



Product can differ from the current configuration.



Mounting cut-outs [mm]

**Additional Information**

- For front dimension 24 x 48 mm
- For LED element fitting information see «Application guidelines»

Each Part Number listed below includes all the black components shown in the 3D-drawing.

To obtain a complete unit, please select the red components from the pages shown.

Product attribute	Contacts	Switching action	Terminal	Part No.	Wiring diagram	Weight
	1 C	B	Screw	<b>03-627.011</b>	1	0.075 kg
		C	Screw	<b>03-628.011</b>	2	0.075 kg
has two independent lamp bases, has independent changeover	2 C	B	Screw	<b>03-624.011</b>	3	0.080 kg
		C	Screw	<b>03-625.011</b>	4	0.080 kg
		B - C	Screw	<b>03-626.011</b>	5	0.080 kg

Contacts: C = Changeover

Switching action: B = Momentary, C = Maintained

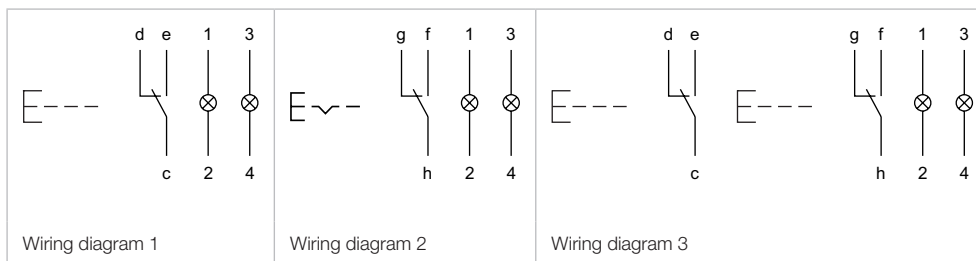

# 03 Flush design

## Keylock switch 2 positions, IP 40



Product can differ from the current configuration.



Dimensions [mm]

### Additional Information

- For front dimension 24 x 48 mm
- Front plastic grey
- After turning the key 90° clockwise, the switch can be operated
- In the unlocked switch positions always perform a momentary action
- Keylock number: Schulte YB1



Mounting cut-outs [mm]

### Equipment consisting of (schematic overview)



**Front bezel** Seite 17



**Keylock front bezel** Seite 15

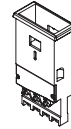

**Actuator**



**Fixing sleeve**

Each Part Number listed below includes all the black components shown in the 3D-drawing.

*To obtain a complete unit, please select the red components from the pages shown.*



Switching positions (A = Rest, B = Momentary)

Product attribute	Contacts	Switching angle	Key remove	Terminal	Part No.	Wiring diagram	Weight
							
A = lockable, actuated	2 C	B = 90°	A	Screw	<b>03-690.011</b>	1	0.065 kg
A = lockable, non-actuated	2 C	B = 90°	A	Screw	<b>03-691.011</b>	1	0.065 kg
A = lockable, non-actuated or actuated	2 C	B = 90°	A	Screw	<b>03-692.011</b>	1	0.065 kg

Contacts: C = Changeover

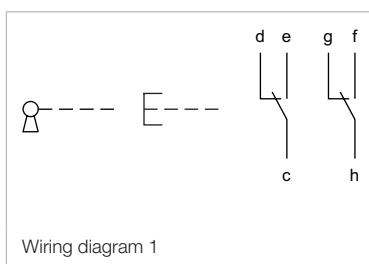

## Keylock switch with keylock front bezel, 2 positions, IP 40

### Equipment consisting of (schematic overview)



**Front bezel** Seite 17



**Keylock front bezel**

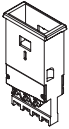

**Actuator**



**Fixing sleeve**

Each Part Number listed below includes all the black components shown in the 3D-drawing.

To obtain a complete unit, please select the red components from the pages shown.

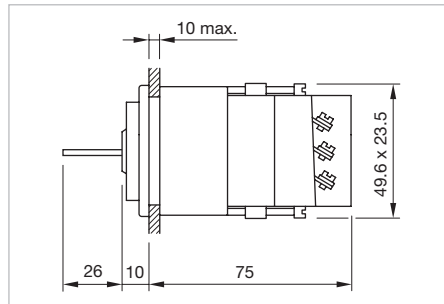

Dimensions [mm]



Product can differ from the current configuration.

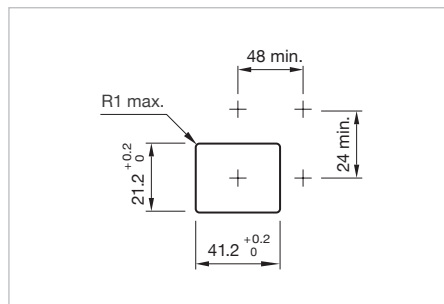

Mounting cut-outs [mm]

### Additional Information

- For front dimension 24 x 48 mm
- Front plastic grey
- After turning the key 90° clockwise, the switch can be operated
- In the unlocked switch positions always perform a momentary action
- Keylock number: Schulte YB1



Switching positions (A = Rest, B = Momentary)

Product attribute	Contacts	Switching angle	Key remove	Terminal	Part No.	Wiring diagram	Weight
							
A = lockable, non-actuated, B = lockable, key not removable	2 C	B = 90°	A	Screw	<b>03-695.011</b>	1	0.065 kg
A = lockable, non-actuated or actuated; can be used with protective cover 03-925	2 C	B = 90°	A	Screw	<b>03-198.011</b>	1	0.065 kg

Contacts: C = Changeover

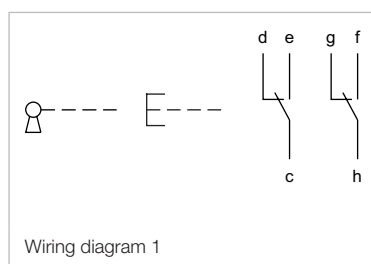

# 03 Flush design

Front

## Lens halved

### Additional Information

- Material plastic, holder metal
- Order two lenses

Product attribute	Dimension	Lens	Part No.	Weight	
 <p><b>Lens halved for pushbutton double-headed</b></p>	18 x 19 mm	illuminative, not suitable for film insert, ripped	smoked translucent	<b>03-921.1</b>	0.005 kg
		red translucent	<b>03-921.2</b>	0.005 kg	
		orange translucent	<b>03-921.3</b>	0.005 kg	
		yellow translucent	<b>03-921.4</b>	0.005 kg	
		green translucent	<b>03-921.5</b>	0.005 kg	
		blue translucent	<b>03-921.6</b>	0.005 kg	
		colourless translucent	<b>03-921.7</b>	0.005 kg	
		white translucent	<b>03-921.9</b>	0.005 kg	
		illuminative, use holder for film insert	18 x 19 mm	colourless transparent	<b>03-943.7</b>
non-illuminative, ripped	18 x 19 mm	black opaque	<b>03-921.0</b>	0.005 kg	
		grey opaque	<b>03-921.8</b>	0.005 kg	
illuminative, with black rim (prevents lateral light escape), use holder for film insert	18 x 19 mm	colourless transparent	<b>03-953.7</b>	0.005 kg	

**Lens single-headed uni-colour**
**Additional Information**

- Material plastic, holder metal

Product attribute	Dimension	Lens	Part No.	Weight
 <p><b>Lens single-headed uni-colour for pushbutton single-headed</b></p>				
illuminative, not suitable for film insert, ripped	18 x 38 mm	smoked translucent	<b>03-901.1</b>	0.009 kg
		red translucent	<b>03-901.2</b>	0.009 kg
		orange translucent	<b>03-901.3</b>	0.009 kg
		yellow translucent	<b>03-901.4</b>	0.009 kg
		green translucent	<b>03-901.5</b>	0.009 kg
		blue translucent	<b>03-901.6</b>	0.009 kg
		colourless translucent	<b>03-901.7</b>	0.009 kg
		white translucent	<b>03-901.9</b>	0.009 kg
illuminative, use holder for film insert	18 x 38 mm	colourless transparent	<b>03-941.7</b>	0.009 kg
illuminative, with black rim (prevents lateral light escape), use holder for film insert	18 x 38 mm	colourless transparent	<b>03-946.7</b>	0.009 kg
		smoked transparent	<b>03-947.1</b>	0.009 kg
non-illuminative, ripped	18 x 38 mm	black opaque	<b>03-901.0</b>	0.009 kg
		grey opaque	<b>03-901.8</b>	0.009 kg

**Lens single-headed bi-colour**
**Additional Information**

- Material plastic, holder metal

Product attribute	Dimension	Lens	Part No.	Weight
 <p><b>Lens single-headed bi-colour for pushbutton single-headed</b></p>				
illuminative, with light barrier, not suitable for film insert, ripped	18 x 38 mm	black-red opaque-translucent	<b>03-902.0/2</b>	0.010 kg
		black-orange opaque-translucent	<b>03-902.0/3</b>	0.010 kg
		black-yellow opaque-translucent	<b>03-902.0/4</b>	0.010 kg
		black-green opaque-translucent	<b>03-902.0/5</b>	0.010 kg
		black-blue opaque-translucent	<b>03-902.0/6</b>	0.010 kg
		black-colourless opaque-translucent	<b>03-902.0/7</b>	0.010 kg
		anthracite-anthracite translucent	<b>03-902.1/1</b>	0.010 kg
		red-red translucent	<b>03-902.2/2</b>	0.010 kg
		red-orange translucent	<b>03-902.2/3</b>	0.010 kg
		red-yellow translucent	<b>03-902.2/4</b>	0.010 kg
		red-green translucent	<b>03-902.2/5</b>	0.010 kg
		red-blue translucent	<b>03-902.2/6</b>	0.010 kg
		red-colourless translucent	<b>03-902.2/7</b>	0.010 kg
		grey-red opaque-translucent	<b>03-902.2/8</b>	0.010 kg
		red-white translucent	<b>03-902.2/9</b>	0.010 kg

# 03 Accessories

Product attribute	Dimension	Lens	Part No.	Weight
illuminative, with light barrier, not suitable for film insert, ripped	18 x 38 mm	orange-orange translucent	<b>03-902.3/3</b>	0.010 kg
		orange-yellow translucent	<b>03-902.3/4</b>	0.010 kg
		orange-green translucent	<b>03-902.3/5</b>	0.010 kg
		orange-blue translucent	<b>03-902.3/6</b>	0.010 kg
		orange-colourless translucent	<b>03-902.3/7</b>	0.010 kg
		grey-orange opaque-translucent	<b>03-902.3/8</b>	0.010 kg
		orange-white translucent	<b>03-902.3/9</b>	0.010 kg
		yellow-yellow translucent	<b>03-902.4/4</b>	0.010 kg
		yellow-green translucent	<b>03-902.4/5</b>	0.010 kg
		yellow-blue translucent	<b>03-902.4/6</b>	0.010 kg
		yellow-colourless translucent	<b>03-902.4/7</b>	0.010 kg
		grey-yellow opaque-translucent	<b>03-902.4/8</b>	0.010 kg
		yellow-white translucent	<b>03-902.4/9</b>	0.010 kg
		green-green translucent	<b>03-902.5/5</b>	0.010 kg
		green-blue translucent	<b>03-902.5/6</b>	0.010 kg
		green-colourless translucent	<b>03-902.5/7</b>	0.010 kg
		grey-green opaque-translucent	<b>03-902.5/8</b>	0.010 kg
		green-white translucent	<b>03-902.5/9</b>	0.010 kg
		blue-blue translucent	<b>03-902.6/6</b>	0.010 kg
		blue-colourless translucent	<b>03-902.6/7</b>	0.010 kg
		grey-blue opaque-translucent	<b>03-902.6/8</b>	0.010 kg
		blue-white translucent	<b>03-902.6/9</b>	0.010 kg
		colourless-colourless translucent	<b>03-902.7/7</b>	0.010 kg
		grey-colourless opaque-translucent	<b>03-902.7/8</b>	0.010 kg
		colourless-white translucent	<b>03-902.7/9</b>	0.010 kg
		black-white opaque-translucent	<b>03-902.0/9</b>	0.010 kg
grey-white opaque-translucent	<b>03-902.8/9</b>	0.010 kg		
white-white translucent	<b>03-902.9/9</b>	0.010 kg		
colourless-colourless transparent	<b>03-942.7/7</b>	0.010 kg		
illuminative, with black rim (prevents lateral light escape), use holder for film insert	18 x 38 mm	colourless-colourless transparent	<b>03-951.7/7</b>	0.010 kg
non-illuminative, ripped	18 x 38 mm	black-black opaque	<b>03-902.0/0</b>	0.010 kg
		black-grey opaque	<b>03-902.0/8</b>	0.010 kg
		grey-grey opaque	<b>03-902.8/8</b>	0.010 kg

**Keylock front bezel**

**Additional Information**

- Standard lock: Schulte YB1

Product attribute	Dimension	Material	Colour	Part No.	Weight
 <p><b>Keylock front bezel</b></p>					
for keylock switch Part No. 03-690, 03-691, 03-692	17.5 x 37.5 mm	Plastic	grey	<b>03-980.1</b>	0.010 kg

**Holder halved**

**Additional Information**

- For use with film insert, order two holders
- For lens halved: Part No. 03-943.7; for lens single-headed bi-colour: Part No. 03-951.7/7

Material	Colour	Optics	Part No.	Weight
 <p><b>Holder halved</b></p>				
Plastic	red	translucent	<b>03-922.2</b>	0.001 kg
	orange	translucent	<b>03-922.3</b>	0.001 kg
	yellow	translucent	<b>03-922.4</b>	0.001 kg
	green	translucent	<b>03-922.5</b>	0.001 kg
	blue	translucent	<b>03-922.6</b>	0.001 kg
	colourless	transparent	<b>03-922.7</b>	0.001 kg
	white	translucent	<b>03-922.9</b>	0.001 kg

# 03 Accessories

## Holder single-headed

### Additional Information

- For film insert
- For lens single-headed uni-colour: Part-No. 03-941.7, 03-946.7 and 03-947.1

Material	Colour	Optics	Part No.	Weight
 <b>Holder single-headed</b>				
Plastic	red	translucent	<b>03-908.2</b>	0.001 kg
	orange	translucent	<b>03-908.3</b>	0.001 kg
	yellow	translucent	<b>03-908.4</b>	0.001 kg
	green	translucent	<b>03-908.5</b>	0.001 kg
	blue	translucent	<b>03-908.6</b>	0.001 kg
	colourless	transparent	<b>03-908.7</b>	0.001 kg
	white	translucent	<b>03-908.9</b>	0.001 kg

## Diffuser plate halved

### Additional Information

- For film insert, order two diffuser plates
- For lens halved and lens single-headed bi-colour, lettering only visible when illuminated

Part No.	Weight
 <b>Diffuser plate halved</b>	
<b>03-926</b>	0.001 kg



**Diffuser plate single-headed**

**Additional Information**

- For film insert
- For lens single-headed uni-colour, lettering only visible when illuminated

Part No.	Weight
 <b>Diffuser plate single-headed</b>	
<b>03-909</b>	0.001 kg

**Front bezel flush**

**Additional Information**

- Lens only removable with lens remover Part No. 02-905

Front bezel	Part No.	Weight
 <b>Front bezel flush, Front dimension 24 x 48 mm</b>		
Plastic black	<b>03-965.0</b>	0.001 kg

**Front bezel raised**

**Additional Information**

- Lens only removable with lens remover Part No. 98-969

Front bezel	Part No.	Weight
 <b>Front bezel raised, Front dimension 24 x 48 mm</b>		
Plastic black	<b>03-967.0</b>	0.001 kg

# 03 Accessories

## Light barrier

Part No.	Weight
 <p><b>Light barrier</b></p>	
<b>03-907</b>	0.002 kg

## Protective cover, IP 40

### Additional Information

- Use only flush front bezel
- Hinged, with means for sealing
- Please note that bigger minimum distances are necessary



Dimensions [mm]

Product attribute	Material	Optics	Dimension	Part No.	Weight
 <p><b>Protective cover</b></p>					
for button with mounting cut-out 21.2 x 41.2 mm	Plastic	transparent	48 x 33 mm	<b>03-925</b>	0.001 kg

**Front protective cap, IP 65**

**Additional Information**

- Use only flush front bezel
- Three-part



Dimensions [mm]



Mounting cut-outs [mm]

Dimension	Material	Colour	Optics	Temperature	Part No.	Weight
 <p><b>Front protective cap</b></p>						
30 x 54 mm	PVC	colourless	transparent	-20 ... +60 °C	<b>03-924</b>	0.005 kg

**Blind plug**



Mounting cut-outs [mm]

Dimension	Mounting cut-out	Material	Colour	Part No.	Weight
 <p><b>Blind plug</b></p>					
24 x 48 mm	21.2 x 41.2 mm	Plastic	black	<b>03-949.0</b>	0.005 kg
			grey	<b>03-949.8</b>	0.005 kg

# 03 Accessories

## Spare key

### Additional Information

- Keylock number: Schulte YB1

Part No.	Weight
 <b>Spare key</b>	
02-989.001	0.001 kg

**Rear side****Terminal cover****Additional Information**

- For all connection methods

Part No.	Weight
 <b>Terminal cover</b>	
03-929	0.007 kg

## Illumination

### Single-LED, T6.8

#### Additional Information

- Order two LEDs
- For LED element fitting information see «Application guidelines»
- Due to high surface temperatures, the series resistor must not be soldered directly to the terminals of the equipment (use a terminal plate)
- When using AC/DC types with AC operation, slight flickering can occur
- Luminous intensity data of the LEDs on direct voltage
- Electrical and optical data are measured at 25 °C
- The specified versions are built with a protection diode (half wave rectifier) in series and the LED
- Luminosity and wave length variations caused by LED manufacturing processes may cause slight differences regarding the illumination
- For supply voltages above 48 V, it is necessary to use a voltage reduction element (external series resistor or transformer)



Dimensions [mm]

LED colour	Operating voltage	Operation current	Lumi. intensity	Dom. wavelength	Part No.	Weight
 <p><b>Single-LED</b></p>						
Single-LED red	6 VDC +10 %	17 mA ±15 %	400 mcd	630 nm	<b>10-2K06.3152</b>	0.002 kg
	12 VAC/DC +10 %	9/17 mA ±15 %	400 mcd	630 nm	<b>10-2K09.1072</b>	0.002 kg
	24 VAC/DC +10 %	9/17 mA ±15 %	400 mcd	630 nm	<b>10-2K12.1072</b>	0.002 kg
	28 VAC/DC +10 %	9/17 mA ±15 %	400 mcd	630 nm	<b>10-2K13.1072</b>	0.002 kg
	48 VAC/DC +10 %	4/8 mA ±15 %	200 mcd	630 nm	<b>10-2K19.1052</b>	0.002 kg
Single-LED yellow	6 VDC +10 %	17 mA ±15 %	340 mcd	340 nm	<b>10-2K06.3154</b>	0.002 kg
	12 VAC/DC +10 %	9/17 mA ±15 %	340 mcd	340 nm	<b>10-2K09.1074</b>	0.002 kg
	24 VAC/DC +10 %	9/17 mA ±15 %	340 mcd	340 nm	<b>10-2K12.1074</b>	0.002 kg
	28 VAC/DC +10 %	9/17 mA ±15 %	340 mcd	340 nm	<b>10-2K13.1074</b>	0.002 kg
	48 VAC/DC +10 %	4/8 mA ±15 %	180 mcd	340 nm	<b>10-2K19.1054</b>	0.002 kg
Single-LED green	6 VDC +10 %	7 mA ±15 %	1050 mcd	525 nm	<b>10-2K06.3155</b>	0.002 kg
	12 VAC/DC +10 %	4/7 mA ±15 %	1050 mcd	525 nm	<b>10-2K09.1075</b>	0.002 kg
	24 VAC/DC +10 %	4/7 mA ±15 %	1050 mcd	525 nm	<b>10-2K12.1075</b>	0.002 kg
	28 VAC/DC +10 %	4/7 mA ±15 %	1050 mcd	525 nm	<b>10-2K13.1075</b>	0.002 kg
	48 VAC/DC +10 %	2/4 mA ±15 %	600 mcd	525 nm	<b>10-2K19.1055</b>	0.002 kg
Single-LED blue	6 VDC +10 %	17 mA ±15 %	780 mcd	470 nm	<b>10-2K06.3156</b>	0.002 kg
	12 VAC/DC +10 %	9/17 mA ±15 %	780 mcd	470 nm	<b>10-2K09.1076</b>	0.002 kg
	24 VAC/DC +10 %	9/17 mA ±15 %	780 mcd	470 nm	<b>10-2K12.1076</b>	0.002 kg
	28 VAC/DC +10 %	9/17 mA ±15 %	780 mcd	470 nm	<b>10-2K13.1076</b>	0.002 kg
	48 VAC/DC +10 %	4/8 mA ±15 %	400 mcd	470 nm	<b>10-2K19.1056</b>	0.002 kg

LED colour	Operating voltage	Operation current	Lumi. intensity	Dom. wavelength	Part No.	Weight
Single-LED white	6 VDC +10 %	6 mA±15 %	900 mcd	x0.31/y0.32 nm	<b>10-2K06.3159</b>	0.002 kg
	12 VAC/DC +10 %	3/6 mA±15 %	900 mcd	x0.31/y0.32 nm	<b>10-2K09.1079</b>	0.002 kg
	24 VAC/DC +10 %	3/6 mA±15 %	900 mcd	x0.31/y0.32 nm	<b>10-2K12.1079</b>	0.002 kg
	28 VAC/DC +10 %	2.5/5 mA±15 %	750 mcd	x0.31/y0.32 nm	<b>10-2K13.1079</b>	0.002 kg
	48 VAC/DC +10 %	2/4 mA±15 %	600 mcd	x0.31/y0.32 nm	<b>10-2K19.1059</b>	0.002 kg

### Filament lamp, T6.8

#### Additional Information

- Order two filament lamps

Operating voltage	Operation current	Part No.	Weight
 <p><b>Filament lamp</b></p>			
12 VAC/DC	50 mA ±10 %	<b>10-1209.1279</b>	0.001 kg
12 VAC/DC	100 mA ±10 %	<b>10-1209.1329</b>	0.001 kg
24 VAC/DC	25 mA ±10 %	<b>10-1212.1199</b>	0.001 kg
24 VAC/DC	50 mA ±10 %	<b>10-1212.1279</b>	0.001 kg
28 VAC/DC	40 mA ±10 %	<b>10-1213.1249</b>	0.001 kg
30 VAC/DC	40 mA ±10 %	<b>10-1214.1249</b>	0.001 kg
36 VAC/DC	35 mA ±10 %	<b>10-1216.1229</b>	0.001 kg

### Series resistor

#### Additional Information

- Only for filament lamp 48 VAC, 25 mA
- For lamp voltage reduction
- Keep to the country specific safety instructions
- Due to high surface temperatures, the series resistor must not be soldered directly to the terminals of the equipment (use a terminal plate)

Operating voltage	Resistance	Part No.	Weight
 <p><b>Series resistor</b></p>			
110 VAC	2.7 kOhm	<b>02-904.0</b>	0.003 kg
125 VAC	3.3 kOhm	<b>02-904.1</b>	0.003 kg
145 VAC	4.7 kOhm	<b>02-904.3</b>	0.003 kg
240 VAC	10 kOhm	<b>02-904.7</b>	0.003 kg

# 03 Accessories

## Terminal plate empty

### Additional Information

- For fitting with series resistors

Product attribute	Dimension	Part No.	Weight
			
<b>Terminal plate empty</b>			
5 spaces	62.5 x 60 x 15 mm	<b>02-912.1</b>	0.025 kg
10 spaces	125 x 60 x 15 mm	<b>02-912.2</b>	0.045 kg
15 spaces	187.6 x 60 x 15 mm	<b>02-912.3</b>	0.090 kg
20 spaces	250 x 60 x 15 mm	<b>02-912.4</b>	0.095 kg



Mounting

Lens remover

Product attribute	Part No.	Weight
 <p><b>Lens remover</b></p>		
for flush front bezel	<b>02-905</b>	0.011 kg
 <p><b>Lens remover</b></p>		
for raised front bezel	<b>98-968</b>	0.004 kg

Lamp remover

Additional Information

▲ **Caution:** A switching process might be released when replacing the lamp

Product attribute	Part No.	Weight
 <p><b>Lamp remover</b></p>		
for LED	<b>03-996</b>	0.027 kg
 <p><b>Lamp remover</b></p>		
for filament lamp	<b>61-9740.0</b>	0.003 kg

# 03 Technical data

## Actuator with snap-action switching element

### Switching system

1 or 2 self-cleaning, snap-action switching elements.  
1 or 2 double-throw contacts.

### Material

#### Material of contact

Standard version:

Silver ( $U > 20\text{V}$ )

Special versions: (on request)

Gold/Silver 700Au/300Ag ( $U < 50\text{V}$ )

Silver/Palladium 700Ag/300Pd ( $U > 20\text{V}$ ) for atmospheres containing sulphur

#### Switch housing

Thermosetting material, heat-resistant

#### Indicator housing

Polyamide

### Mechanical characteristics

#### Terminals

Screw terminal (with self-lifting clip):

max. wire cross-section,  $2 \times 2.5\text{mm}^2$

max. wire cross-section of stranded cable,  $2 \times 1.5\text{mm}^2$

#### Tightening torque

For fixing sleeve max. 20Ncm

For screw terminal max. 80Ncm

#### Actuating force

6N... 12N

#### Actuating travel

5mm

#### Mechanical lifetime

Momentary action 2 million operations

Maintained action 1 million operations

### Electrical characteristics

#### Standards

The switches comply with the "Standards for low-voltage switching devices" EN IEC 60947-5-1

#### Rated insulation voltage

400VAC/440VDC, as per IEC 60947-5-1

#### Conventional free air thermal current

10A

The maximum current in continuous operation and at ambient temperature not exceeding the quoted maximum values.

#### Switch rating

400VAC, 10A,  $\cos\phi$  0.95, as per IEC 60947-5-1

250VAC, 10A, as per UL

#### Electric strength

2500VAC, 50Hz, 1 min. between all terminals and earth,

as per IEC 60947-5-1

### Environmental conditions

#### Storage temperature

$-30^\circ\text{C} \dots +85^\circ\text{C}$

#### Service temperature

$-25^\circ\text{C} \dots +55^\circ\text{C}$

For indicators and illuminated pushbuttons mounted as a block, make sure the heat can escape freely.

#### Protection degree

Front side IP 40, IP 65 with spray cover, as per IEC 60529

#### Vibration resistance

10g at 10...2000Hz, amplitude 1.0mm, as per IEC 60068-2-6

### Approvals

#### Approbations

CB (IEC 60947-5-1)

CSA

Germanischer Lloyd

UL

#### Declaration of conformity

CE

**Buzzer**
**Buzzer system**
**System**

Contactless electronic buzzer with IC oscillator

**Operation Voltage/Current**

typical

10 ... 55 VAC    10 ... 75 VDC

25 mA            15 mA

**Material**
**Buzzer case**

Duroplastic

**Front cap**

Polycarbonate (PC)

**Front bezel**

Polymethylacrylate

**Environmental conditions**
**Storage temperature**

-40 °C ... +85 °C

**Service temperature**

-25 °C ... +55 °C

**Protection degree**

Front side IP 40, as per IEC 60529

**Mechanical characteristics**
**Terminals**

Screw terminal

**Tightening torque**

For fixing sleeve max. 20 Ncm

For screw terminal max. 80 Ncm

**Approvals**
**Approbations**

CB (IEC 60947-5-1)

**Declaration of conformity**

CE

**Electrical characteristics**
**Frequency (tone)**

Approx. 2.8 kHz

**Sound pressure**

85 dB (A) ±8 dB at a distance of 0.1 m

Volume variable with a 1 MΩ potentiometer or corresponding fixed resistor

*EAO reserves the right to alter specifications without further notice.*

# 03 Marking

## General notes

### 1. Engraving

In addition to the most commonly used world languages, in DIN1451-3 close spacing, other typefaces are available as Scandinavian, Slavic, Greek, Russian and Polish. Red, blue and black lenses are filled with white colour. Other colour lenses are filled in black. Standard height of letters is 3 mm. If the height is not specified, we will supply 3 mm engraved letters.

### 2. Hot stamping

For larger series it is worth considering markings by means of hot stamping. We will be pleased to advise you. For letters and figures, typefaces with 2.5 mm, 3 mm and 4 mm are available.

### 3. Film inserts

Instead of using engraving the lenses can be fitted with transparent film inserts, as an alternative. For this purpose, though, it is advisable to use lenses without ripped pattern. In the case of use of a smoke-black lens the fitted film becomes readable only if the lamp is on. The film (F) is inserted in the cap. To ensure even illumination a diffusor (D) is recommended, which is inserted beneath the film. If, on the other hand, the diffusor is inserted above the film, the lettering only becomes legible when the lamp is alight. To hold the film and diffusor in position, the use of a holder (N) is advised. The film thickness is 0.2 mm.

All dimensions in mm

Lens size	Film insert max. size	Height of letters h	Number of lines	Number of capital letters per line (target value)	Number of small letters per line (target value)	Image
18 x 19	14.3 x 15.6	3	4	7-8	9-10	B3
						B4
		4	2	5	6	B3
						B4
		5	2	4	4	B3
						B4
		6	1	3	4	B3
						B4
		8	1	2	2	B3
						B4
18 x 38	14.3 x 34.3	3	4	16	18	B1
			8	6	8	B2
		4	2	11	13	B1
			4	4	5	B2
		5	2	8	10	B1
			4	3	4	B2
		6	1	7	9	B1
			3	3	3	B2
		8	1	5	6	B1
			2	2	2	B2

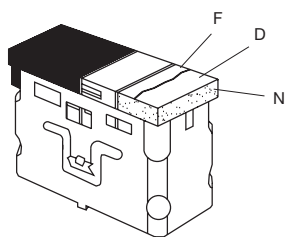

## Suppressor circuits

When switching inductive loads such as relays, DC motors, and DC solenoids, it is always important to absorb surges (e.g. with a diode) to protect the contacts. When these inductive loads are switched off, a counter emf can severely damage switch contacts and greatly shorten lifetime.

Fig. 1 shows an inductive load with a free-wheeling diode connected in parallel. This free-wheeling diode provides a path for the inductor current to flow when the current is interrupted by the switch. Without this free-wheeling diode, the voltage across the coil will be limited only by dielectric breakdown voltages of the circuit or parasitic elements of the coil. This voltage can be kilovolts in amplitude even when nominal circuit voltages are low (e.g. 12VDC) see Fig. 2.

The free-wheeling diode should be chosen so that the reverse breakdown voltage is greater than the voltage driving the inductive load. The DC blocking voltage ( $V_R$ ) of the free-wheeling diode can be found in the datasheet of a diode. The forward current should be equal or greater than the maximum current flowing through the load.

**To get an efficient protection, the free-wheeling diode must be connected as close as possible to the inductive load!**

Switching with inductive load  
Fig. 1



Counter EMF  
over load without free-wheeling diode  
Fig. 2



## LED polarity

When fitting the LED elements the polarity has to correspond with the respective terminals, (+) goes to +.



## Index from Part No.

Part No.	Page	Part No.	Page	Part No.	Page
02-904.0	23	03-902.5/6	14	10-2K12.1076	22
02-904.1	23	03-902.5/7	14	10-2K12.1079	23
02-904.3	23	03-902.5/8	14	10-2K13.1072	22
02-904.7	23	03-902.5/9	14	10-2K13.1074	22
02-905	25	03-902.6/6	14	10-2K13.1075	22
02-912.1	24	03-902.6/7	14	10-2K13.1076	22
02-912.2	24	03-902.6/8	14	10-2K13.1079	23
02-912.3	24	03-902.6/9	14	10-2K19.1052	22
02-912.4	24	03-902.7/7	14	10-2K19.1054	22
02-989.001	20	03-902.7/8	14	10-2K19.1055	22
03-021.001	4	03-902.7/9	14	10-2K19.1056	22
03-198.011	11	03-902.8/8	14	10-2K19.1059	23
03-611.011	6	03-902.8/9	14	61-9740.0	25
03-612.011	6	03-902.9/9	14	98-968	25
03-613.011	6	03-907	18		
03-614.011	6	03-908.2	16		
03-615.011	6	03-908.3	16		
03-616.011	8	03-908.4	16		
03-617.011	8	03-908.5	16		
03-618.011	8	03-908.6	16		
03-619.011	8	03-908.7	16		
03-620.011	8	03-908.9	16		
03-621.011	7	03-909	17		
03-622.011	7	03-921.0	12		
03-623.011	7	03-921.1	12		
03-624.011	9	03-921.2	12		
03-625.011	9	03-921.3	12		
03-626.011	9	03-921.4	12		
03-627.011	9	03-921.5	12		
03-628.011	9	03-921.6	12		
03-690.011	10	03-921.7	12		
03-691.011	10	03-921.8	12		
03-692.011	10	03-921.9	12		
03-695.011	11	03-922.2	15		
03-810.001	5	03-922.3	15		
03-901.0	13	03-922.4	15		
03-901.1	13	03-922.5	15		
03-901.2	13	03-922.6	15		
03-901.3	13	03-922.7	15		
03-901.4	13	03-922.9	15		
03-901.5	13	03-924	19		
03-901.6	13	03-925	18		
03-901.7	13	03-926	16		
03-901.8	13	03-929	21		
03-901.9	13	03-941.7	13		
03-902.0/0	14	03-942.7/7	14		
03-902.0/2	13	03-943.7	12		
03-902.0/3	13	03-946.7	13		
03-902.0/4	13	03-947.1	13		
03-902.0/5	13	03-949.0	19		
03-902.0/6	13	03-949.8	19		
03-902.0/7	13	03-951.7/7	14		
03-902.0/8	14	03-953.7	12		
03-902.0/9	14	03-965.0	17		
03-902.1/1	13	03-967.0	17		
03-902.2/2	13	03-980.1	15		
03-902.2/3	13	03-996	25		
03-902.2/4	13	10-1209.1279	23		
03-902.2/5	13	10-1209.1329	23		
03-902.2/6	13	10-1212.1199	23		
03-902.2/7	13	10-1212.1279	23		
03-902.2/8	13	10-1213.1249	23		
03-902.2/9	13	10-1214.1249	23		
03-902.3/3	14	10-1216.1229	23		
03-902.3/4	14	10-2K06.3152	22		
03-902.3/5	14	10-2K06.3154	22		
03-902.3/6	14	10-2K06.3155	22		
03-902.3/7	14	10-2K06.3156	22		
03-902.3/8	14	10-2K06.3159	23		
03-902.3/9	14	10-2K09.1072	22		
03-902.4/4	14	10-2K09.1074	22		
03-902.4/5	14	10-2K09.1075	22		
03-902.4/6	14	10-2K09.1076	22		
03-902.4/7	14	10-2K09.1079	23		
03-902.4/8	14	10-2K12.1072	22		
03-902.4/9	14	10-2K12.1074	22		
03-902.5/5	14	10-2K12.1075	22		

Компания «Life Electronics» занимается поставками электронных компонентов импортного и отечественного производства от производителей и со складов крупных дистрибьюторов Европы, Америки и Азии.

С конца 2013 года компания активно расширяет линейку поставок компонентов по направлению коаксиальный кабель, кварцевые генераторы и конденсаторы (керамические, пленочные, электролитические), за счёт заключения дистрибьюторских договоров

Мы предлагаем:

- Конкурентоспособные цены и скидки постоянным клиентам.
- Специальные условия для постоянных клиентов.
- Подбор аналогов.
- Поставку компонентов в любых объемах, удовлетворяющих вашим потребностям.
- Приемлемые сроки поставки, возможна ускоренная поставка.
- Доставку товара в любую точку России и стран СНГ.
- Комплексную поставку.
- Работу по проектам и поставку образцов.
- Формирование склада под заказчика.
- Сертификаты соответствия на поставляемую продукцию (по желанию клиента).
- Тестирование поставляемой продукции.
- Поставку компонентов, требующих военную и космическую приемку.
- Входной контроль качества.
- Наличие сертификата ISO.

В составе нашей компании организован Конструкторский отдел, призванный помогать разработчикам, и инженерам.

Конструкторский отдел помогает осуществить:

- Регистрацию проекта у производителя компонентов.
- Техническую поддержку проекта.
- Защиту от снятия компонента с производства.
- Оценку стоимости проекта по компонентам.
- Изготовление тестовой платы монтаж и пусконаладочные работы.



Тел: +7 (812) 336 43 04 (многоканальный)

Email: [org@lifeelectronics.ru](mailto:org@lifeelectronics.ru)