

Series 03

Characteristics

The robust and compact Series 03 is especially suited for:

- Flush design

The large rectangular design (24x48mm) provides the option for dual illumination in addition to the "XL" illuminated surface.

Functions

The Series 03 incorporates the following functions:

- Indicator
- Pushbutton
- Illuminated pushbutton
- Keylock switch
- Buzzer

Market segments

The EAO Series 03 is especially suited for applications in the segments:

- Ship building
- Panel building

Please refer to the EAO website to obtain detailed information regarding this series www.products.eao.com
Configure a product to your exact needs and request a quotation.



Overview**Flush design**

| | |
|------------------------|----|
| Indicator | 4 |
| Buzzer | 5 |
| Pushbutton | 6 |
| Illuminated pushbutton | 8 |
| Keylock switch | 10 |

Accessories 12**Technical data** 26**Marking** 28**Application guidelines** 29**Index** 30

03 Flush design

Indicator, IP 40



Product can differ from the current configuration.



Dimensions [mm]

Additional Information

- For front dimension 24 x 48 mm
- For LED element fitting information see «Application guidelines»
- Has two independent lamp bases
- Light barrier ordered separately



Mounting cut-outs [mm]

Equipment consisting of (schematic overview)



Each Part Number listed below includes all the black components shown in the 3D-drawing.

To obtain a complete unit, please select the red components from the pages shown.

| Terminal | Part No. | Wiring diagram | Weight |
|---|-------------------|----------------|----------|
|  <p>Indicator actuator</p> | 03-021.001 | 1 | 0.045 kg |



Buzzer, IP 40

Equipment consisting of (schematic overview)



Dimensions [mm]



Product can differ from the current configuration.

Each Part Number listed below includes all the black components shown in the 3D-drawing.

To obtain a complete unit, please select the red components from the pages shown.



Mounting cut-outs [mm]

Additional Information

- For front dimension 24 x 48 mm
- Further information see «Technical data»

| Operating voltage | Front cap | Terminal | Part No. | Wiring diagram | Weight |
|--|---------------|----------|-------------------|----------------|----------|
|  <p>Buzzer</p> | | | | | |
| 10 ... 55 VAC, 10 ... 75 VDC | Plastic black | Screw | 03-810.001 | 1 | 0.060 kg |



03 Flush design

Pushbutton single-headed, IP 40



Product can differ from the current configuration.



Dimensions [mm]

Additional Information

- For front dimension 24 x 48 mm



Mounting cut-outs [mm]

Equipment consisting of (schematic overview)



Each Part Number listed below includes all the black components shown in the 3D-drawing.

To obtain a complete unit, please select the red components from the pages shown.

| Contacts | Switching action | Terminal | Part No. | Wiring diagram | Weight |
|--|------------------|----------|-------------------|----------------|----------|
|  <p>Pushbutton actuator single-headed</p> | | | | | |
| 1 C | B | Screw | 03-611.011 | 1 | 0.055 kg |
| | C | Screw | 03-613.011 | 2 | 0.055 kg |
| 2 C | B | Screw | 03-612.011 | 3 | 0.065 kg |
| | C | Screw | 03-614.011 | 4 | 0.065 kg |
| | B - C | Screw | 03-615.011 | 5 | 0.065 kg |

Contacts: C = Changeover

Switching action: B = Momentary, C = Maintained



Pushbutton actuator double-headed, IP 40

Equipment consisting of (schematic overview)



Each Part Number listed below includes all the black components shown in the 3D-drawing.

To obtain a complete unit, please select the red components from the pages shown.



Dimensions [mm]



Product can differ from the current configuration.



Mounting cut-outs [mm]

Additional Information

- For front dimension 24 x 48 mm
- Has independent changeover

| Contacts | Switching action | Terminal | Part No. | Wiring diagram | Weight |
|----------|------------------|----------|-------------------|----------------|----------|
| | B | Screw | 03-621.011 | 1 | 0.065 kg |
| | C | Screw | 03-622.011 | 2 | 0.065 kg |
| | B - C | Screw | 03-623.011 | 3 | 0.065 kg |

Contacts: C = Changeover

Switching action: B = Momentary, C = Maintained

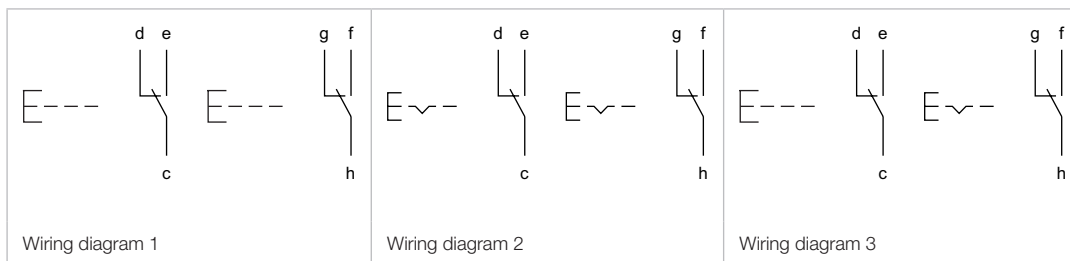

03 Flush design

Illuminated pushbutton single headed, IP 40



Product can differ from the current configuration.



Dimensions [mm]

Additional Information

- For front dimension 24 x 48 mm
- For LED element fitting information see «Application guidelines»
- Has two independent lamp bases
- Light barrier ordered separately



Mounting cut-outs [mm]

Equipment consisting of (schematic overview)



Each Part Number listed below includes all the black components shown in the 3D-drawing.

To obtain a complete unit, please select the red components from the pages shown.

| Contacts | Switching action | Terminal | Part No. | Wiring diagram | Weight |
|--|------------------|----------|-------------------|----------------|----------|
|  Illuminated pushbutton actuator single-headed | | | | | |
| 1 C | B | Screw | 03-616.011 | 1 | 0.070 kg |
| | C | Screw | 03-618.011 | 2 | 0.070 kg |
| 2 C | B | Screw | 03-617.011 | 3 | 0.075 kg |
| | C | Screw | 03-619.011 | 4 | 0.075 kg |
| | B - C | Screw | 03-620.011 | 5 | 0.075 kg |

Contacts: C = Changeover
Switching action: B = Momentary, C = Maintained



Illuminated pushbutton double-headed, IP 40

Equipment consisting of (schematic overview)

-  **Front bezel** Seite 17
-  **Lens** Seite 13
-  **LED** Seite 22
-  **Actuator**
-  **Fixing sleeve**



Dimensions [mm]



Product can differ from the current configuration.



Mounting cut-outs [mm]

Additional Information

- For front dimension 24 x 48 mm
- For LED element fitting information see «Application guidelines»

Each Part Number listed below includes all the black components shown in the 3D-drawing.

To obtain a complete unit, please select the red components from the pages shown.

| Product attribute | Contacts | Switching action | Terminal | Part No. | Wiring diagram | Weight |
|---|----------|------------------|----------|-------------------|----------------|----------|
|  | 1 C | B | Screw | 03-627.011 | 1 | 0.075 kg |
| | | C | Screw | 03-628.011 | 2 | 0.075 kg |
| has two independent lamp bases, has independent changeover | 2 C | B | Screw | 03-624.011 | 3 | 0.080 kg |
| | | C | Screw | 03-625.011 | 4 | 0.080 kg |
| | | B - C | Screw | 03-626.011 | 5 | 0.080 kg |

Contacts: C = Changeover
Switching action: B = Momentary, C = Maintained

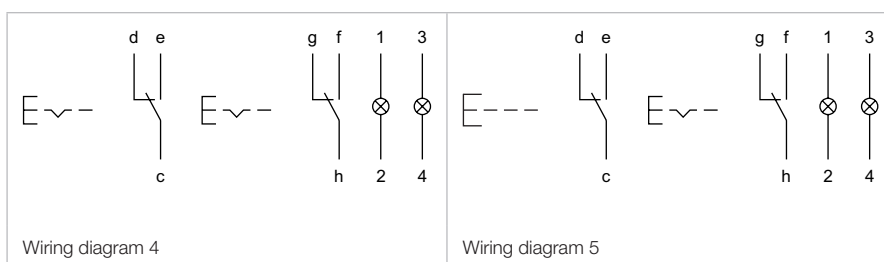
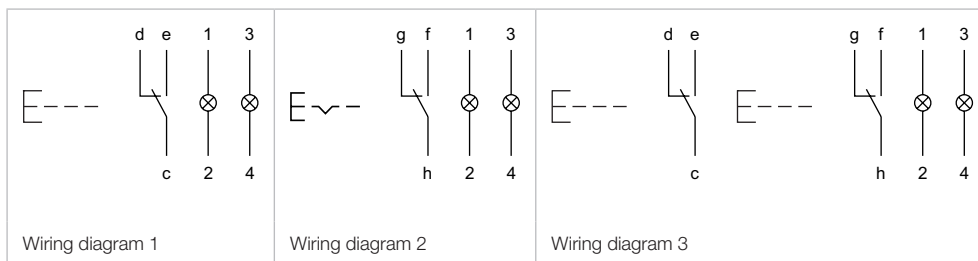

03 Flush design

Keylock switch 2 positions, IP 40



Product can differ from the current configuration.



Additional Information

- For front dimension 24 x 48 mm
- Front plastic grey
- After turning the key 90° clockwise, the switch can be operated
- In the unlocked switch positions always perform a momentary action
- Keylock number: Schulte YB1



Equipment consisting of (schematic overview)

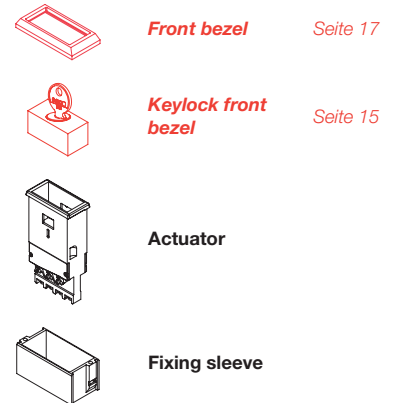

Each Part Number listed below includes all the black components shown in the 3D-drawing.

To obtain a complete unit, please select the red components from the pages shown.



Switching positions (A = Rest, B = Momentary)



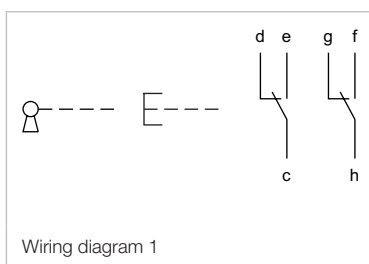

| Product attribute | Contacts | Switching angle | Key remove | Terminal | Part No. | Wiring diagram | Weight |
|---|----------|-----------------|------------|----------|-------------------|----------------|----------|
|  | | | | | | | |
| A = lockable, actuated | 2 C | B = 90° | A | Screw | 03-690.011 | 1 | 0.065 kg |
| A = lockable, non-actuated | 2 C | B = 90° | A | Screw | 03-691.011 | 1 | 0.065 kg |
| A = lockable, non-actuated or actuated | 2 C | B = 90° | A | Screw | 03-692.011 | 1 | 0.065 kg |

Contacts: C = Changeover

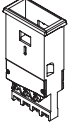

Keylock switch with keylock front bezel, 2 positions, IP 40

Equipment consisting of (schematic overview)

-  **Front bezel** Seite 17
-  **Keylock front bezel**
-  **Actuator**
-  **Fixing sleeve**

Each Part Number listed below includes all the black components shown in the 3D-drawing.

To obtain a complete unit, please select the red components from the pages shown.

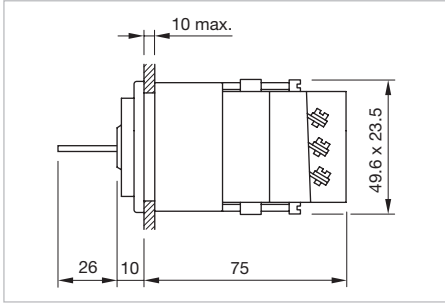

Dimensions [mm]



Product can differ from the current configuration.

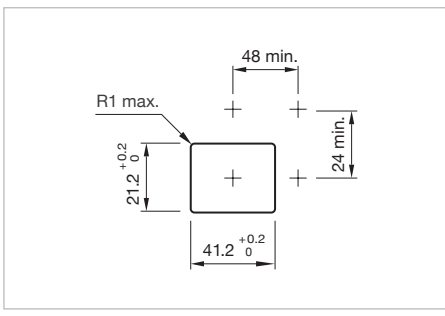

Mounting cut-outs [mm]

Additional Information

- For front dimension 24 x 48 mm
- Front plastic grey
- After turning the key 90° clockwise, the switch can be operated
- In the unlocked switch positions always perform a momentary action
- Keylock number: Schulte YB1



Switching positions (A = Rest, B = Momentary)

| Product attribute | Contacts | Switching angle | Key remove | Terminal | Part No. | Wiring diagram | Weight |
|---|----------|-----------------|------------|----------|-------------------|----------------|----------|
|  | | | | | | | |
| A = lockable, non-actuated, B = lockable, key not removable | 2 C | B = 90° | A | Screw | 03-695.011 | 1 | 0.065 kg |
| A = lockable, non-actuated or actuated; can be used with protective cover 03-925 | 2 C | B = 90° | A | Screw | 03-198.011 | 1 | 0.065 kg |

Contacts: C = Changeover

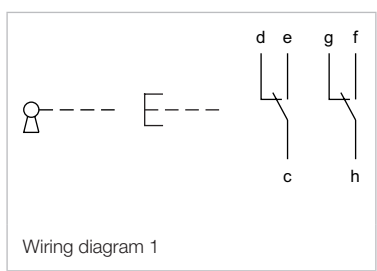

03 Flush design

Front

Lens halved

Additional Information

- Material plastic, holder metal
- Order two lenses

| Product attribute | Dimension | Lens | Part No. | Weight | |
|--|------------|--|--------------------|------------------------|-----------------|
|  <p>Lens halved for pushbutton double-headed</p> | 18 x 19 mm | illuminative, not suitable for film insert, ripped | smoked translucent | 03-921.1 | 0.005 kg |
| | | red translucent | 03-921.2 | 0.005 kg | |
| | | orange translucent | 03-921.3 | 0.005 kg | |
| | | yellow translucent | 03-921.4 | 0.005 kg | |
| | | green translucent | 03-921.5 | 0.005 kg | |
| | | blue translucent | 03-921.6 | 0.005 kg | |
| | | colourless translucent | 03-921.7 | 0.005 kg | |
| | | white translucent | 03-921.9 | 0.005 kg | |
| | | illuminative, use holder for film insert | 18 x 19 mm | colourless transparent | 03-943.7 |
| non-illuminative, ripped | 18 x 19 mm | black opaque | 03-921.0 | 0.005 kg | |
| | | grey opaque | 03-921.8 | 0.005 kg | |
| illuminative, with black rim (prevents lateral light escape), use holder for film insert | 18 x 19 mm | colourless transparent | 03-953.7 | 0.005 kg | |

Lens single-headed uni-colour
Additional Information

- Material plastic, holder metal

| Product attribute | Dimension | Lens | Part No. | Weight |
|--|------------|------------------------|-----------------|----------|
|  <p>Lens single-headed uni-colour for pushbutton single-headed</p> | | | | |
| illuminative, not suitable for film insert, ripped | 18 x 38 mm | smoked translucent | 03-901.1 | 0.009 kg |
| | | red translucent | 03-901.2 | 0.009 kg |
| | | orange translucent | 03-901.3 | 0.009 kg |
| | | yellow translucent | 03-901.4 | 0.009 kg |
| | | green translucent | 03-901.5 | 0.009 kg |
| | | blue translucent | 03-901.6 | 0.009 kg |
| | | colourless translucent | 03-901.7 | 0.009 kg |
| | | white translucent | 03-901.9 | 0.009 kg |
| illuminative, use holder for film insert | 18 x 38 mm | colourless transparent | 03-941.7 | 0.009 kg |
| illuminative, with black rim (prevents lateral light escape), use holder for film insert | 18 x 38 mm | colourless transparent | 03-946.7 | 0.009 kg |
| | | smoked transparent | 03-947.1 | 0.009 kg |
| non-illuminative, ripped | 18 x 38 mm | black opaque | 03-901.0 | 0.009 kg |
| | | grey opaque | 03-901.8 | 0.009 kg |

Lens single-headed bi-colour
Additional Information

- Material plastic, holder metal

| Product attribute | Dimension | Lens | Part No. | Weight |
|---|------------|-------------------------------------|-------------------|----------|
|  <p>Lens single-headed bi-colour for pushbutton single-headed</p> | | | | |
| illuminative, with light barrier, not suitable for film insert, ripped | 18 x 38 mm | black-red opaque-translucent | 03-902.0/2 | 0.010 kg |
| | | black-orange opaque-translucent | 03-902.0/3 | 0.010 kg |
| | | black-yellow opaque-translucent | 03-902.0/4 | 0.010 kg |
| | | black-green opaque-translucent | 03-902.0/5 | 0.010 kg |
| | | black-blue opaque-translucent | 03-902.0/6 | 0.010 kg |
| | | black-colourless opaque-translucent | 03-902.0/7 | 0.010 kg |
| | | anthracite-anthracite translucent | 03-902.1/1 | 0.010 kg |
| | | red-red translucent | 03-902.2/2 | 0.010 kg |
| | | red-orange translucent | 03-902.2/3 | 0.010 kg |
| | | red-yellow translucent | 03-902.2/4 | 0.010 kg |
| | | red-green translucent | 03-902.2/5 | 0.010 kg |
| | | red-blue translucent | 03-902.2/6 | 0.010 kg |
| | | red-colourless translucent | 03-902.2/7 | 0.010 kg |
| | | grey-red opaque-translucent | 03-902.2/8 | 0.010 kg |
| | | red-white translucent | 03-902.2/9 | 0.010 kg |

03 Accessories

| Product attribute | Dimension | Lens | Part No. | Weight |
|--|-------------------|------------------------------------|-------------------|----------|
| illuminative, with light barrier, not suitable for film insert, ripped | 18 x 38 mm | orange-orange translucent | 03-902.3/3 | 0.010 kg |
| | | orange-yellow translucent | 03-902.3/4 | 0.010 kg |
| | | orange-green translucent | 03-902.3/5 | 0.010 kg |
| | | orange-blue translucent | 03-902.3/6 | 0.010 kg |
| | | orange-colourless translucent | 03-902.3/7 | 0.010 kg |
| | | grey-orange opaque-translucent | 03-902.3/8 | 0.010 kg |
| | | orange-white translucent | 03-902.3/9 | 0.010 kg |
| | | yellow-yellow translucent | 03-902.4/4 | 0.010 kg |
| | | yellow-green translucent | 03-902.4/5 | 0.010 kg |
| | | yellow-blue translucent | 03-902.4/6 | 0.010 kg |
| | | yellow-colourless translucent | 03-902.4/7 | 0.010 kg |
| | | grey-yellow opaque-translucent | 03-902.4/8 | 0.010 kg |
| | | yellow-white translucent | 03-902.4/9 | 0.010 kg |
| | | green-green translucent | 03-902.5/5 | 0.010 kg |
| | | green-blue translucent | 03-902.5/6 | 0.010 kg |
| | | green-colourless translucent | 03-902.5/7 | 0.010 kg |
| | | grey-green opaque-translucent | 03-902.5/8 | 0.010 kg |
| | | green-white translucent | 03-902.5/9 | 0.010 kg |
| | | blue-blue translucent | 03-902.6/6 | 0.010 kg |
| | | blue-colourless translucent | 03-902.6/7 | 0.010 kg |
| | | grey-blue opaque-translucent | 03-902.6/8 | 0.010 kg |
| | | blue-white translucent | 03-902.6/9 | 0.010 kg |
| | | colourless-colourless translucent | 03-902.7/7 | 0.010 kg |
| | | grey-colourless opaque-translucent | 03-902.7/8 | 0.010 kg |
| | | colourless-white translucent | 03-902.7/9 | 0.010 kg |
| | | black-white opaque-translucent | 03-902.0/9 | 0.010 kg |
| | | grey-white opaque-translucent | 03-902.8/9 | 0.010 kg |
| white-white translucent | 03-902.9/9 | 0.010 kg | | |
| colourless-colourless transparent | 03-942.7/7 | 0.010 kg | | |
| illuminative, with black rim (prevents lateral light escape), use holder for film insert | 18 x 38 mm | colourless-colourless transparent | 03-951.7/7 | 0.010 kg |
| non-illuminative, ripped | 18 x 38 mm | black-black opaque | 03-902.0/0 | 0.010 kg |
| | | black-grey opaque | 03-902.0/8 | 0.010 kg |
| | | grey-grey opaque | 03-902.8/8 | 0.010 kg |

Keylock front bezel

Additional Information

- Standard lock: Schulte YB1

| Product attribute | Dimension | Material | Colour | Part No. | Weight |
|---|----------------|----------|--------|-----------------|----------|
|  <p>Keylock front bezel</p> | | | | | |
| for keylock switch Part No. 03-690, 03-691, 03-692 | 17.5 x 37.5 mm | Plastic | grey | 03-980.1 | 0.010 kg |

Holder halved

Additional Information

- For use with film insert, order two holders
- For lens halved: Part No. 03-943.7; for lens single-headed bi-colour: Part No. 03-951.7/7

| Material | Colour | Optics | Part No. | Weight |
|---|------------|-------------|-----------------|----------|
|  <p>Holder halved</p> | | | | |
| Plastic | red | translucent | 03-922.2 | 0.001 kg |
| | orange | translucent | 03-922.3 | 0.001 kg |
| | yellow | translucent | 03-922.4 | 0.001 kg |
| | green | translucent | 03-922.5 | 0.001 kg |
| | blue | translucent | 03-922.6 | 0.001 kg |
| | colourless | transparent | 03-922.7 | 0.001 kg |
| | white | translucent | 03-922.9 | 0.001 kg |

03 Accessories

Holder single-headed

Additional Information

- For film insert
- For lens single-headed uni-colour: Part-No. 03-941.7, 03-946.7 and 03-947.1

| Material | Colour | Optics | Part No. | Weight |
|---|------------|-------------|-----------------|----------|
|  Holder single-headed | | | | |
| Plastic | red | translucent | 03-908.2 | 0.001 kg |
| | orange | translucent | 03-908.3 | 0.001 kg |
| | yellow | translucent | 03-908.4 | 0.001 kg |
| | green | translucent | 03-908.5 | 0.001 kg |
| | blue | translucent | 03-908.6 | 0.001 kg |
| | colourless | transparent | 03-908.7 | 0.001 kg |
| | white | translucent | 03-908.9 | 0.001 kg |

Diffuser plate halved

Additional Information

- For film insert, order two diffuser plates
- For lens halved and lens single-headed bi-colour, lettering only visible when illuminated

| Part No. | Weight |
|---|----------|
|  Diffuser plate halved | |
| 03-926 | 0.001 kg |

Diffuser plate single-headed

Additional Information

- For film insert
- For lens single-headed uni-colour, lettering only visible when illuminated

| Part No. | Weight |
|--|----------|
|  <p>Diffuser plate single-headed</p> | |
| 03-909 | 0.001 kg |

Front bezel flush

Additional Information

- Lens only removable with lens remover Part No. 02-905

| Front bezel | Part No. | Weight |
|---|-----------------|----------|
|  <p>Front bezel flush, Front dimension 24 x 48 mm</p> | | |
| Plastic black | 03-965.0 | 0.001 kg |

Front bezel raised

Additional Information

- Lens only removable with lens remover Part No. 98-969

| Front bezel | Part No. | Weight |
|--|-----------------|----------|
|  <p>Front bezel raised, Front dimension 24 x 48 mm</p> | | |
| Plastic black | 03-967.0 | 0.001 kg |

03 Accessories

Light barrier

| Part No. | Weight |
|---|----------|
|  <p>Light barrier</p> | |
| 03-907 | 0.002 kg |

Protective cover, IP 40

Additional Information

- Use only flush front bezel
- Hinged, with means for sealing
- Please note that bigger minimum distances are necessary

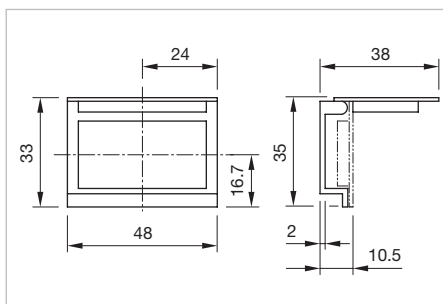

Dimensions [mm]

| Product attribute | Material | Optics | Dimension | Part No. | Weight |
|---|----------|-------------|------------|---------------|----------|
|  <p>Protective cover</p> | | | | | |
| for button with mounting cut-out 21.2 x 41.2 mm | Plastic | transparent | 48 x 33 mm | 03-925 | 0.001 kg |

Front protective cap, IP 65

Additional Information

- Use only flush front bezel
- Three-part



Dimensions [mm]



Mounting cut-outs [mm]

| Dimension | Material | Colour | Optics | Temperature | Part No. | Weight |
|--|----------|------------|-------------|----------------|---------------|----------|
|  <p>Front protective cap</p> | | | | | | |
| 30 x 54 mm | PVC | colourless | transparent | -20 ... +60 °C | 03-924 | 0.005 kg |

Blind plug



Mounting cut-outs [mm]

| Dimension | Mounting cut-out | Material | Colour | Part No. | Weight |
|--|------------------|----------|--------|-----------------|----------|
|  <p>Blind plug</p> | | | | | |
| 24 x 48 mm | 21.2 x 41.2 mm | Plastic | black | 03-949.0 | 0.005 kg |
| | | | grey | 03-949.8 | 0.005 kg |

03 Accessories

Spare key

Additional Information

- Keylock number: Schulte YB1

| Part No. | Weight |
|---|----------|
|  Spare key | |
| 02-989.001 | 0.001 kg |

Rear side**Terminal cover****Additional Information**

- For all connection methods

| Part No. | Weight |
|--|----------|
|  Terminal cover | |
| 03-929 | 0.007 kg |

Illumination

Single-LED, T6.8

Additional Information

- Order two LEDs
- For LED element fitting information see «Application guidelines»
- Due to high surface temperatures, the series resistor must not be soldered directly to the terminals of the equipment (use a terminal plate)
- When using AC/DC types with AC operation, slight flickering can occur
- Luminous intensity data of the LEDs on direct voltage
- Electrical and optical data are measured at 25 °C
- The specified versions are built with a protection diode (half wave rectifier) in series and the LED
- Luminosity and wave length variations caused by LED manufacturing processes may cause slight differences regarding the illumination
- For supply voltages above 48 V, it is necessary to use a voltage reduction element (external series resistor or transformer)



Dimensions [mm]

| LED colour | Operating voltage | Operation current | Lumi. intensity | Dom. wavelength | Part No. | Weight |
|---|-------------------|-------------------|-----------------|-----------------|---------------------|----------|
|  <p>Single-LED</p> | | | | | | |
| Single-LED red | 6 VDC +10 % | 17 mA ±15 % | 400 mcd | 630 nm | 10-2K06.3152 | 0.002 kg |
| | 12 VAC/DC +10 % | 9/17 mA ±15 % | 400 mcd | 630 nm | 10-2K09.1072 | 0.002 kg |
| | 24 VAC/DC +10 % | 9/17 mA ±15 % | 400 mcd | 630 nm | 10-2K12.1072 | 0.002 kg |
| | 28 VAC/DC +10 % | 9/17 mA ±15 % | 400 mcd | 630 nm | 10-2K13.1072 | 0.002 kg |
| | 48 VAC/DC +10 % | 4/8 mA ±15 % | 200 mcd | 630 nm | 10-2K19.1052 | 0.002 kg |
| Single-LED yellow | 6 VDC +10 % | 17 mA ±15 % | 340 mcd | 340 nm | 10-2K06.3154 | 0.002 kg |
| | 12 VAC/DC +10 % | 9/17 mA ±15 % | 340 mcd | 340 nm | 10-2K09.1074 | 0.002 kg |
| | 24 VAC/DC +10 % | 9/17 mA ±15 % | 340 mcd | 340 nm | 10-2K12.1074 | 0.002 kg |
| | 28 VAC/DC +10 % | 9/17 mA ±15 % | 340 mcd | 340 nm | 10-2K13.1074 | 0.002 kg |
| | 48 VAC/DC +10 % | 4/8 mA ±15 % | 180 mcd | 340 nm | 10-2K19.1054 | 0.002 kg |
| Single-LED green | 6 VDC +10 % | 7 mA ±15 % | 1050 mcd | 525 nm | 10-2K06.3155 | 0.002 kg |
| | 12 VAC/DC +10 % | 4/7 mA ±15 % | 1050 mcd | 525 nm | 10-2K09.1075 | 0.002 kg |
| | 24 VAC/DC +10 % | 4/7 mA ±15 % | 1050 mcd | 525 nm | 10-2K12.1075 | 0.002 kg |
| | 28 VAC/DC +10 % | 4/7 mA ±15 % | 1050 mcd | 525 nm | 10-2K13.1075 | 0.002 kg |
| | 48 VAC/DC +10 % | 2/4 mA ±15 % | 600 mcd | 525 nm | 10-2K19.1055 | 0.002 kg |
| Single-LED blue | 6 VDC +10 % | 17 mA ±15 % | 780 mcd | 470 nm | 10-2K06.3156 | 0.002 kg |
| | 12 VAC/DC +10 % | 9/17 mA ±15 % | 780 mcd | 470 nm | 10-2K09.1076 | 0.002 kg |
| | 24 VAC/DC +10 % | 9/17 mA ±15 % | 780 mcd | 470 nm | 10-2K12.1076 | 0.002 kg |
| | 28 VAC/DC +10 % | 9/17 mA ±15 % | 780 mcd | 470 nm | 10-2K13.1076 | 0.002 kg |
| | 48 VAC/DC +10 % | 4/8 mA ±15 % | 400 mcd | 470 nm | 10-2K19.1056 | 0.002 kg |

| LED colour | Operating voltage | Operation current | Lumi. intensity | Dom. wavelength | Part No. | Weight |
|------------------|-------------------|-------------------|-----------------|-----------------|---------------------|----------|
| Single-LED white | 6 VDC +10 % | 6 mA±15 % | 900 mcd | x0.31/y0.32 nm | 10-2K06.3159 | 0.002 kg |
| | 12 VAC/DC +10 % | 3/6 mA±15 % | 900 mcd | x0.31/y0.32 nm | 10-2K09.1079 | 0.002 kg |
| | 24 VAC/DC +10 % | 3/6 mA±15 % | 900 mcd | x0.31/y0.32 nm | 10-2K12.1079 | 0.002 kg |
| | 28 VAC/DC +10 % | 2.5/5 mA±15 % | 750 mcd | x0.31/y0.32 nm | 10-2K13.1079 | 0.002 kg |
| | 48 VAC/DC +10 % | 2/4 mA±15 % | 600 mcd | x0.31/y0.32 nm | 10-2K19.1059 | 0.002 kg |

Filament lamp, T6.8

Additional Information

- Order two filament lamps

| Operating voltage | Operation current | Part No. | Weight |
|---|-------------------|---------------------|----------|
|  <p>Filament lamp</p> | | | |
| 12 VAC/DC | 50 mA ±10 % | 10-1209.1279 | 0.001 kg |
| 12 VAC/DC | 100 mA ±10 % | 10-1209.1329 | 0.001 kg |
| 24 VAC/DC | 25 mA ±10 % | 10-1212.1199 | 0.001 kg |
| 24 VAC/DC | 50 mA ±10 % | 10-1212.1279 | 0.001 kg |
| 28 VAC/DC | 40 mA ±10 % | 10-1213.1249 | 0.001 kg |
| 30 VAC/DC | 40 mA ±10 % | 10-1214.1249 | 0.001 kg |
| 36 VAC/DC | 35 mA ±10 % | 10-1216.1229 | 0.001 kg |

Series resistor

Additional Information

- Only for filament lamp 48 VAC, 25 mA
- For lamp voltage reduction
- Keep to the country specific safety instructions
- Due to high surface temperatures, the series resistor must not be soldered directly to the terminals of the equipment (use a terminal plate)

| Operating voltage | Resistance | Part No. | Weight |
|---|------------|-----------------|----------|
|  <p>Series resistor</p> | | | |
| 110 VAC | 2.7 kOhm | 02-904.0 | 0.003 kg |
| 125 VAC | 3.3 kOhm | 02-904.1 | 0.003 kg |
| 145 VAC | 4.7 kOhm | 02-904.3 | 0.003 kg |
| 240 VAC | 10 kOhm | 02-904.7 | 0.003 kg |

03 Accessories

Terminal plate empty

Additional Information

- For fitting with series resistors



| Product attribute | Dimension | Part No. | Weight |
|---|--------------------|-----------------|----------|
|  Terminal plate empty | | | |
| 5 spaces | 62.5 x 60 x 15 mm | 02-912.1 | 0.025 kg |
| 10 spaces | 125 x 60 x 15 mm | 02-912.2 | 0.045 kg |
| 15 spaces | 187.6 x 60 x 15 mm | 02-912.3 | 0.090 kg |
| 20 spaces | 250 x 60 x 15 mm | 02-912.4 | 0.095 kg |

Mounting**Lens remover**

| Product attribute | Part No. | Weight |
|--|---------------|----------|
|  <p>Lens remover</p> | | |
| for flush front bezel | 02-905 | 0.011 kg |
|  <p>Lens remover</p> | | |
| for raised front bezel | 98-968 | 0.004 kg |

Lamp remover**Additional Information**

▲ **Caution:** A switching process might be released when replacing the lamp

| Product attribute | Part No. | Weight |
|--|------------------|----------|
|  <p>Lamp remover</p> | | |
| for LED | 03-996 | 0.027 kg |
|  <p>Lamp remover</p> | | |
| for filament lamp | 61-9740.0 | 0.003 kg |

03 Technical data

Actuator with snap-action switching element

Switching system

1 or 2 self-cleaning, snap-action switching elements.
1 or 2 double-throw contacts.

Material

Material of contact

Standard version:

Silver ($U > 20\text{ V}$)

Special versions: (on request)

Gold/Silver 700Au/300 Ag ($U < 50\text{ V}$)

Silver/Palladium 700Ag/300 Pd ($U > 20\text{ V}$) for atmospheres containing sulphur

Switch housing

Thermosetting material, heat-resistant

Indicator housing

Polyamide

Mechanical characteristics

Terminals

Screw terminal (with self-lifting clip):

max. wire cross-section, $2 \times 2.5\text{ mm}^2$

max. wire cross-section of stranded cable, $2 \times 1.5\text{ mm}^2$

Tightening torque

For fixing sleeve max. 20 Ncm

For screw terminal max. 80 Ncm

Actuating force

6 N... 12 N

Actuating travel

5 mm

Mechanical lifetime

Momentary action 2 million operations

Maintained action 1 million operations

Electrical characteristics

Standards

The switches comply with the "Standards for low-voltage switching devices" EN IEC 60947-5-1

Rated insulation voltage

400 VAC/440 VDC, as per IEC 60947-5-1

Conventional free air thermal current

10 A

The maximum current in continuous operation and at ambient temperature not exceeding the quoted maximum values.

Switch rating

400 VAC, 10 A, $\cos\phi$ 0.95, as per IEC 60947-5-1

250 VAC, 10 A, as per UL

Electric strength

2500 VAC, 50 Hz, 1 min. between all terminals and earth,

as per IEC 60947-5-1

Environmental conditions

Storage temperature

$-30\text{ }^\circ\text{C} \dots +85\text{ }^\circ\text{C}$

Service temperature

$-25\text{ }^\circ\text{C} \dots +55\text{ }^\circ\text{C}$

For indicators and illuminated pushbuttons mounted as a block, make sure the heat can escape freely.

Protection degree

Front side IP 40, IP 65 with spray cover, as per IEC 60529

Vibration resistance

10 g at 10 ... 2000 Hz, amplitude 1.0 mm, as per IEC 60068-2-6

Approvals

Approbations

CB (IEC 60947-5-1)

CSA

Germanischer Lloyd

UL

Declaration of conformity

CE

Buzzer
Buzzer system
System

Contactless electronic buzzer with IC oscillator

Operation Voltage/Current

typical

10 ... 55 VAC 10 ... 75 VDC

25 mA 15 mA

Material
Buzzer case

Duroplastic

Front cap

Polycarbonate (PC)

Front bezel

Polymethylacrylate

Environmental conditions
Storage temperature

-40 °C ... +85 °C

Service temperature

-25 °C ... +55 °C

Protection degree

Front side IP 40, as per IEC 60529

Mechanical characteristics
Terminals

Screw terminal

Tightening torque

For fixing sleeve max. 20 Ncm

For screw terminal max. 80 Ncm

Approvals
Approbations

CB (IEC 60947-5-1)

Declaration of conformity

CE

Electrical characteristics
Frequency (tone)

Approx. 2.8 kHz

Sound pressure

85 dB (A) ±8 dB at a distance of 0.1 m

Volume variable with a 1 MΩ potentiometer or corresponding fixed resistor

EAO reserves the right to alter specifications without further notice.

03 Marking

General notes

1. Engraving

In addition to the most commonly used world languages, in DIN1451-3 close spacing, other typefaces are available as Scandinavian, Slavic, Greek, Russian and Polish. Red, blue and black lenses are filled with white colour. Other colour lenses are filled in black. Standard height of letters is 3 mm. If the height is not specified, we will supply 3 mm engraved letters.

2. Hot stamping

For larger series it is worth considering markings by means of hot stamping. We will be pleased to advise you. For letters and figures, typefaces with 2.5 mm, 3 mm and 4 mm are available.

3. Film inserts

Instead of using engraving the lenses can be fitted with transparent film inserts, as an alternative. For this purpose, though, it is advisable to use lenses without ripped pattern. In the case of use of a smoke-black lens the fitted film becomes readable only if the lamp is on. The film (F) is inserted in the cap. To ensure even illumination a diffusor (D) is recommended, which is inserted beneath the film. If, on the other hand, the diffusor is inserted above the film, the lettering only becomes legible when the lamp is alight. To hold the film and diffusor in position, the use of a holder (N) is advised. The film thickness is 0.2 mm.

All dimensions in mm

| Lens size | Film insert max. size | Height of letters h | Number of lines | Number of capital letters per line (target value) | Number of small letters per line (target value) | Image |
|-----------|-----------------------|---------------------|-----------------|---|---|-------|
| 18 x 19 | 14.3 x 15.6 | 3 | 4 | 7-8 | 9-10 | B3 |
| | | | | | | B4 |
| | | 4 | 2 | 5 | 6 | B3 |
| | | | | | | B4 |
| | | 5 | 2 | 4 | 4 | B3 |
| | | | | | | B4 |
| | | 6 | 1 | 3 | 4 | B3 |
| | | | | | | B4 |
| | | 8 | 1 | 2 | 2 | B3 |
| | | | | | | B4 |
| 18 x 38 | 14.3 x 34.3 | 3 | 4 | 16 | 18 | B1 |
| | | | 8 | 6 | 8 | B2 |
| | | 4 | 2 | 11 | 13 | B1 |
| | | | 4 | 4 | 5 | B2 |
| | | 5 | 2 | 8 | 10 | B1 |
| | | | 4 | 3 | 4 | B2 |
| | | 6 | 1 | 7 | 9 | B1 |
| | | | 3 | 3 | 3 | B2 |
| | | 8 | 1 | 5 | 6 | B1 |
| | | | 2 | 2 | 2 | B2 |



Suppressor circuits

When switching inductive loads such as relays, DC motors, and DC solenoids, it is always important to absorb surges (e.g. with a diode) to protect the contacts. When these inductive loads are switched off, a counter emf can severely damage switch contacts and greatly shorten lifetime.

Fig. 1 shows an inductive load with a free-wheeling diode connected in parallel. This free-wheeling diode provides a path for the inductor current to flow when the current is interrupted by the switch. Without this free-wheeling diode, the voltage across the coil will be limited only by dielectric breakdown voltages of the circuit or parasitic elements of the coil. This voltage can be kilovolts in amplitude even when nominal circuit voltages are low (e.g. 12VDC) see Fig. 2.

The free-wheeling diode should be chosen so that the reverse breakdown voltage is greater than the voltage driving the inductive load. The DC blocking voltage (V_R) of the free-wheeling diode can be found in the datasheet of a diode. The forward current should be equal or greater than the maximum current flowing through the load.

To get an efficient protection, the free-wheeling diode must be connected as close as possible to the inductive load!

Switching with inductive load
Fig. 1



Counter EMF
over load without free-wheeling diode
Fig. 2



LED polarity

When fitting the LED elements the polarity has to correspond with the respective terminals, (+) goes to +.



Index from Part No.

| Part No. | Page | Part No. | Page | Part No. | Page |
|------------|------|--------------|------|--------------|------|
| 02-904.0 | 23 | 03-902.5/6 | 14 | 10-2K12.1076 | 22 |
| 02-904.1 | 23 | 03-902.5/7 | 14 | 10-2K12.1079 | 23 |
| 02-904.3 | 23 | 03-902.5/8 | 14 | 10-2K13.1072 | 22 |
| 02-904.7 | 23 | 03-902.5/9 | 14 | 10-2K13.1074 | 22 |
| 02-905 | 25 | 03-902.6/6 | 14 | 10-2K13.1075 | 22 |
| 02-912.1 | 24 | 03-902.6/7 | 14 | 10-2K13.1076 | 22 |
| 02-912.2 | 24 | 03-902.6/8 | 14 | 10-2K13.1079 | 23 |
| 02-912.3 | 24 | 03-902.6/9 | 14 | 10-2K19.1052 | 22 |
| 02-912.4 | 24 | 03-902.7/7 | 14 | 10-2K19.1054 | 22 |
| 02-989.001 | 20 | 03-902.7/8 | 14 | 10-2K19.1055 | 22 |
| 03-021.001 | 4 | 03-902.7/9 | 14 | 10-2K19.1056 | 22 |
| 03-198.011 | 11 | 03-902.8/8 | 14 | 10-2K19.1059 | 23 |
| 03-611.011 | 6 | 03-902.8/9 | 14 | 61-9740.0 | 25 |
| 03-612.011 | 6 | 03-902.9/9 | 14 | 98-968 | 25 |
| 03-613.011 | 6 | 03-907 | 18 | | |
| 03-614.011 | 6 | 03-908.2 | 16 | | |
| 03-615.011 | 6 | 03-908.3 | 16 | | |
| 03-616.011 | 8 | 03-908.4 | 16 | | |
| 03-617.011 | 8 | 03-908.5 | 16 | | |
| 03-618.011 | 8 | 03-908.6 | 16 | | |
| 03-619.011 | 8 | 03-908.7 | 16 | | |
| 03-620.011 | 8 | 03-908.9 | 16 | | |
| 03-621.011 | 7 | 03-909 | 17 | | |
| 03-622.011 | 7 | 03-921.0 | 12 | | |
| 03-623.011 | 7 | 03-921.1 | 12 | | |
| 03-624.011 | 9 | 03-921.2 | 12 | | |
| 03-625.011 | 9 | 03-921.3 | 12 | | |
| 03-626.011 | 9 | 03-921.4 | 12 | | |
| 03-627.011 | 9 | 03-921.5 | 12 | | |
| 03-628.011 | 9 | 03-921.6 | 12 | | |
| 03-690.011 | 10 | 03-921.7 | 12 | | |
| 03-691.011 | 10 | 03-921.8 | 12 | | |
| 03-692.011 | 10 | 03-921.9 | 12 | | |
| 03-695.011 | 11 | 03-922.2 | 15 | | |
| 03-810.001 | 5 | 03-922.3 | 15 | | |
| 03-901.0 | 13 | 03-922.4 | 15 | | |
| 03-901.1 | 13 | 03-922.5 | 15 | | |
| 03-901.2 | 13 | 03-922.6 | 15 | | |
| 03-901.3 | 13 | 03-922.7 | 15 | | |
| 03-901.4 | 13 | 03-922.9 | 15 | | |
| 03-901.5 | 13 | 03-924 | 19 | | |
| 03-901.6 | 13 | 03-925 | 18 | | |
| 03-901.7 | 13 | 03-926 | 16 | | |
| 03-901.8 | 13 | 03-929 | 21 | | |
| 03-901.9 | 13 | 03-941.7 | 13 | | |
| 03-902.0/0 | 14 | 03-942.7/7 | 14 | | |
| 03-902.0/2 | 13 | 03-943.7 | 12 | | |
| 03-902.0/3 | 13 | 03-946.7 | 13 | | |
| 03-902.0/4 | 13 | 03-947.1 | 13 | | |
| 03-902.0/5 | 13 | 03-949.0 | 19 | | |
| 03-902.0/6 | 13 | 03-949.8 | 19 | | |
| 03-902.0/7 | 13 | 03-951.7/7 | 14 | | |
| 03-902.0/8 | 14 | 03-953.7 | 12 | | |
| 03-902.0/9 | 14 | 03-965.0 | 17 | | |
| 03-902.1/1 | 13 | 03-967.0 | 17 | | |
| 03-902.2/2 | 13 | 03-980.1 | 15 | | |
| 03-902.2/3 | 13 | 03-996 | 25 | | |
| 03-902.2/4 | 13 | 10-1209.1279 | 23 | | |
| 03-902.2/5 | 13 | 10-1209.1329 | 23 | | |
| 03-902.2/6 | 13 | 10-1212.1199 | 23 | | |
| 03-902.2/7 | 13 | 10-1212.1279 | 23 | | |
| 03-902.2/8 | 13 | 10-1213.1249 | 23 | | |
| 03-902.2/9 | 13 | 10-1214.1249 | 23 | | |
| 03-902.3/3 | 14 | 10-1216.1229 | 23 | | |
| 03-902.3/4 | 14 | 10-2K06.3152 | 22 | | |
| 03-902.3/5 | 14 | 10-2K06.3154 | 22 | | |
| 03-902.3/6 | 14 | 10-2K06.3155 | 22 | | |
| 03-902.3/7 | 14 | 10-2K06.3156 | 22 | | |
| 03-902.3/8 | 14 | 10-2K06.3159 | 23 | | |
| 03-902.3/9 | 14 | 10-2K09.1072 | 22 | | |
| 03-902.4/4 | 14 | 10-2K09.1074 | 22 | | |
| 03-902.4/5 | 14 | 10-2K09.1075 | 22 | | |
| 03-902.4/6 | 14 | 10-2K09.1076 | 22 | | |
| 03-902.4/7 | 14 | 10-2K09.1079 | 23 | | |
| 03-902.4/8 | 14 | 10-2K12.1072 | 22 | | |
| 03-902.4/9 | 14 | 10-2K12.1074 | 22 | | |
| 03-902.5/5 | 14 | 10-2K12.1075 | 22 | | |

Компания «Life Electronics» занимается поставками электронных компонентов импортного и отечественного производства от производителей и со складов крупных дистрибьюторов Европы, Америки и Азии.

С конца 2013 года компания активно расширяет линейку поставок компонентов по направлению коаксиальный кабель, кварцевые генераторы и конденсаторы (керамические, пленочные, электролитические), за счёт заключения дистрибьюторских договоров

Мы предлагаем:

- Конкуренспособные цены и скидки постоянным клиентам.
- Специальные условия для постоянных клиентов.
- Подбор аналогов.
- Поставку компонентов в любых объемах, удовлетворяющих вашим потребностям.
- Приемлемые сроки поставки, возможна ускоренная поставка.
- Доставку товара в любую точку России и стран СНГ.
- Комплексную поставку.
- Работу по проектам и поставку образцов.
- Формирование склада под заказчика.
- Сертификаты соответствия на поставляемую продукцию (по желанию клиента).
- Тестирование поставляемой продукции.
- Поставку компонентов, требующих военную и космическую приемку.
- Входной контроль качества.
- Наличие сертификата ISO.

В составе нашей компании организован Конструкторский отдел, призванный помогать разработчикам, и инженерам.

Конструкторский отдел помогает осуществить:

- Регистрацию проекта у производителя компонентов.
- Техническую поддержку проекта.
- Защиту от снятия компонента с производства.
- Оценку стоимости проекта по компонентам.
- Изготовление тестовой платы монтаж и пусконаладочные работы.



Тел: +7 (812) 336 43 04 (многоканальный)
Email: org@lifeelectronics.ru