

# Poke-Home: Single Vertical Contact

## 18-24 AWG: WTB

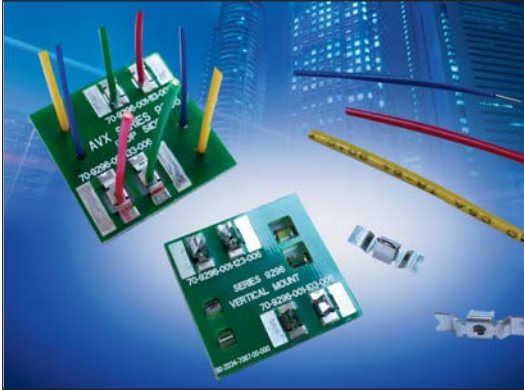

### Series 9296



AVX continues to develop innovative connectors for the industrial electronics market that provide significant benefits over existing, outdated connector solutions. The latest release is single vertical Wire-to-Board (WTB) contacts that provide cost effective, yet robust discrete wire termination without the expense of an insulator and assembly costs. This new family of top and bottom entry contacts compliments the existing vertical poke home connectors already on the market, providing a lower cost solution without jeopardizing performance.

The new contacts support both solid and stranded wires ranging from 24AWG down to 18AWG and current ratings as high as 12 amps. The set of four contacts provide both top and bottom entry for FR4 and metal core printed circuit boards.

### APPLICATIONS

- Machine Controls: motors, drives, solenoids, sensors, fans and pumps
- Commercial Buildings: controls, security, fire and sensors
- Smart Grid: meters, breakers and panels
- SSL/LED; bulbs, fixtures, signage and streetlights

### FEATURES AND BENEFITS

- Dual Beam contact provides maximum mechanical stability and wire retention
- Tape and reel packaged for automated SMT placement
- Staged current rating based on AWG, maximum is 12A (18AWG)
- Increased functionality with the single contact placement: multiple contacts and/or specific individual locations

### ELECTRICAL

- Voltage Rating: Based on placement distance
- Current Rating: See matrix below

### ENVIRONMENTAL

- Operating Temperature: -40°C to +125°C

### MECHANICAL

- Contact Material: Phosphor Bronze
- Contact Plating: Tin over Nickel
- Durability: 5 Cycles

### HOW TO ORDER

**70**  
Prefix  
70 = Contact

**9296**  
Series

**001**  
Number of Ways  
001 = 1

**1X3**  
Contact Style

**006**  
Plating Option  
006 = Tin Plated



Code	Contact Location	Wire Insertion Direction	Recommended For Board Type	Wire Gauges
103	Top Side	Bottom Entry	FR4	18AWG - 24 AWG
113	Through Board	Top Entry	FR4	18AWG - 24 AWG
123	Top Side	Bottom Entry	Metal Clad	18AWG - 24 AWG
133	Through Board	Top Entry	Metal Clad	18AWG - 24 AWG

### CURRENT RATING

18AWG	20AWG	22AWG	24AWG
12A	10A	8A	7A



# Poke-Home: Single Vertical Contact

## 18-24 AWG: WTB



Series 9296

70-9296-001-103-006

### 9296 VERTICAL MOUNT SMT CONTACT TOP SIDE CONTACT – BOTTOM ENTRY WIRE (FR4 BOARD)



### SUGGESTED PCB LAYOUT



#### NOTES:

1. CONTACT MOUNTS ON TOP SIDE OF BOARD, WIRE INSERTED FROM UNDER-SIDE OF BOARD.
2. STYLE RECOMMENDED FOR FR4 BOARDS WHERE MINIMUM CLEARANCE REQUIRED TO CONTACT AND MOUNTING PADS.
3. FOR FURTHER INFORMATION REFER TO ELCO SPECIFICATION 201-01-143 AND APPLICATION NOTES 201-01-150.
4. MATERIAL: TIN PLATED PHOSPHOR BRONZE.
5. HOLE FOR WIRE INSERTION.
6. PACING IN TAPE AND REEL, 2000 PIECES PER REEL.
7. FOR WIRE TRIM DETAILS REFER TO PAGE 6.

### PACKING DETAILS



330mm DIAMETER REEL



# Poke-Home: Single Vertical Contact

## 18-24 AWG: WTB



Series 9296

70-9296-001-113-006

### 9296 VERTICAL MOUNT SMT CONTACT

### THROUGH BOARD CONTACT – TOP ENTRY WIRE (FR4 BOARD)



### SUGGESTED PCB LAYOUT



NOTES:

1. CONTACT MOUNTS THROUGH THE BOARD, WIRE INSERTED FROM TOP SIDE OF BOARD.
2. STYLE RECOMMENDED FOR FR4 BOARDS WHERE MINIMUM CLEARANCE REQUIRED TO CONTACT AND MOUNTING PADS.
3. FOR FURTHER INFORMATION REFER TO ELCO SPECIFICATION 201-01-143 AND APPLICATION NOTES 201-01-150.
4. MATERIAL: TIN PLATED PHOSPHOR BRONZE.
5. HOLE DIMENSIONS FOR CONTACT.
6. PACING IN TAPE AND REEL, 2000 PIECES PER REEL.
7. FOR WIRE TRIM DETAILS REFER TO PAGE 6.

### PACKING DETAILS

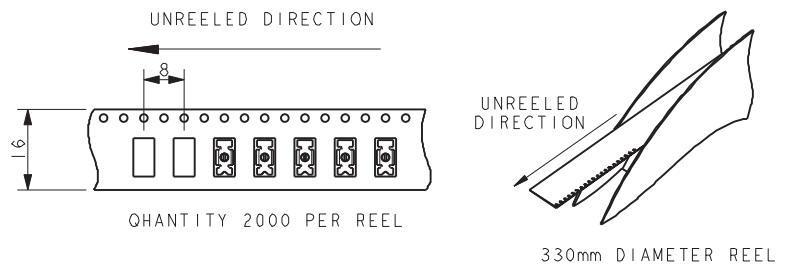

# Poke-Home: Single Vertical Contact

## 18-24 AWG: WTB



Series 9296

70-9296-001-123-006

9296 VERTICAL MOUNT SMT CONTACT

TOP SIDE CONTACT – BOTTOM ENTRY WIRE (METAL BOARD)



### SUGGESTED PCB LAYOUT



#### NOTES:

1. CONTACT MOUNTS ON TOP SIDE OF BOARD, WIRE INSERTED FROM UNDERSIDE OF BOARD.
2. STYLE RECOMMENDED FOR METAL CLAD BOARDS WHERE MAXIMUM CLEARANCE REQUIRED TO CONTACT AND MOUNTING PADS.
3. FOR FURTHER INFORMATION REFER TO ELCO SPECIFICATION 201-01-143 AND APPLICATION NOTES 201-01-150.
4. MATERIAL: TIN PLATED PHOSPHOR BRONZE.
5. HOLE FOR WIRE INSERTION.
6. PACING IN TAPE AND REEL, 1600 PIECES PER REEL.
7. FOR WIRE TRIM DETAILS REFER TO PAGE 6.

### PACKING DETAILS



# Poke-Home: Single Vertical Contact

## 18-24 AWG: WTB



Series 9296

70-9296-001-133-006

### 9296 VERTICAL MOUNT SMT CONTACT THROUGH BOARD CONTACT – TOP ENTRY WIRE (METAL BOARD)



THROUGH BOARD CONTACT



TOP ENTRY WIRE

### SUGGESTED PCB LAYOUT



#### NOTES:

1. CONTACT MOUNTS THROUGH THE BOARD, WIRE INSERTED FROM TOP SIDE OF BOARD.
2. STYLE RECOMMENDED FOR METAL CLAD BOARDS WHERE ADDITIONAL CLEARANCE REQUIRED TO CONTACT AND MOUNTING PADS.
3. FOR FURTHER INFORMATION REFER TO ELCO SPECIFICATION 201-01-143 AND APPLICATION NOTES 201-01-150.
4. MATERIAL: TIN PLATED PHOSPHOR BRONZE.
5. HOLE DIMENSIONS FOR CONTACT.
6. PACING IN TAPE AND REEL, 2000 PIECES PER REEL.
7. FOR WIRE TRIM DETAILS REFER TO PAGE 6.

### PACKING DETAILS

UNREELLED DIRECTION



QUANTITY 2000 PER REEL

UNREELLED DIRECTION



330mm DIAMETER REEL



# Poke-Home: Single Vertical Contact

## 18-24 AWG: WTB



Series 9296

### 9296 VERTICAL MOUNT SMT CONTACT WIRE TRIM DETAILS



WIRE STRIP LENGTH, ALL STYLES



70-9296-001-103-006



70-9296-001-113-006



70-9296-001-123-006



70-9296-001-133-006

NOTES:

1. FOR FULL ASSEMBLY PROCEDURE REFER TO APPLICATION NOTES 201-01-150.
2. THE SAME WIRE STRIP LENGTH APPLIES TO ALL STYLES.
3. STRANDED WIRES SHOULD BE TWISTED TO PREVENT SINGLE STRANDS BECOMING DETACHED WHEN INSERTED INTO CONTACT.

Компания «Life Electronics» занимается поставками электронных компонентов импортного и отечественного производства от производителей и со складов крупных дистрибьюторов Европы, Америки и Азии.

С конца 2013 года компания активно расширяет линейку поставок компонентов по направлению коаксиальный кабель, кварцевые генераторы и конденсаторы (керамические, пленочные, электролитические), за счёт заключения дистрибьюторских договоров

Мы предлагаем:

- Конкурентоспособные цены и скидки постоянным клиентам.
- Специальные условия для постоянных клиентов.
- Подбор аналогов.
- Поставку компонентов в любых объемах, удовлетворяющих вашим потребностям.
- Приемлемые сроки поставки, возможна ускоренная поставка.
- Доставку товара в любую точку России и стран СНГ.
- Комплексную поставку.
- Работу по проектам и поставку образцов.
- Формирование склада под заказчика.
- Сертификаты соответствия на поставляемую продукцию (по желанию клиента).
- Тестирование поставляемой продукции.
- Поставку компонентов, требующих военную и космическую приемку.
- Входной контроль качества.
- Наличие сертификата ISO.

В составе нашей компании организован Конструкторский отдел, призванный помогать разработчикам, и инженерам.

Конструкторский отдел помогает осуществить:

- Регистрацию проекта у производителя компонентов.
- Техническую поддержку проекта.
- Защиту от снятия компонента с производства.
- Оценку стоимости проекта по компонентам.
- Изготовление тестовой платы монтаж и пусконаладочные работы.



Тел: +7 (812) 336 43 04 (многоканальный)

Email: [org@lifeelectronics.ru](mailto:org@lifeelectronics.ru)