

WSMP™ Coaxial RF Connectors and RF Coaxial Cable Assemblies

For High Density Applications to 100GHz



- Signal Integrity to 100GHz
- Center to Center Spacing 2.15 mm (0.085")
Board to Board Height of 3.05 (0.120")
- 45% Smaller Than SMP
35% Smaller Than Mini SMP (SMPM)
- Custom Footprints for Optimized RF Performance on Your PC Board
- Custom RF Cable Assemblies for Your Application
- R100 Series and R65 Series Products On Request

SPECIFICATIONS

Interface

According to Rosenberger WSMP™ Interface standards

Material and plating

Connector parts	Material	Plating
Center contact	CuBe	Gold
Outer contact	CuBe	Gold
Dielectric	PTFE, Polyimide, or Corning 7070™ Glass*	

Electrical data

Impedance	50 Ω
Frequency	DC to 100 GHz
Return loss (typical)	≥ 26 dB, DC to 26.5 GHz ≥ 19 dB, 26.5 to 65 GHz
Insertion loss	≤ 0.12 x √f(GHz) dB
Insulation resistance	≥ 3.5 x 10 ³ MΩ
Center contact resistance	≤ 2.0 mΩ
Outer contact resistance	≤ 6.0 mΩ
Test voltage (at sea level)	250 V rms
RF High Potential (at sea level)	150 V rms @ 5 MHz
RF-leakage (optional)	≥ -80 dB (typical mated pair)

Mechanical data

Mating cycle	
Full Detent (FD)	≥ 100
Smooth Bore (SB)	≥ 500

Mechanical data

Engagement force (typical)		
Full Detent (FD)	11 N	2.47 Lbs.
Smooth Bore (SB)	5.3 N	1.19 Lbs.
Disengagement force (typical)		
Full Detent (FD)	20 N	4.5 Lbs.
Smooth Bore (SB)	4.45 N	1.0 Lbs.

Axial Mis-Alignment

.000-.005 inches

Radial Mis-Alignment

+/- .010 inches

Environmental data

Temperature range	-55° C to +165° C
Thermal shock	MIL-STD-202, Meth. 107, Cond. B
Corrosion	MIL-STD-202, Meth. 101
Vibration	MIL-STD-202, Meth. 204, Cond. D
Shock	MIL-STD-202, Meth. 213, Cond. I
Moisture resistance	MIL-STD-202, Meth. 106, except Step 7B
Max. soldering temperature (optional)	IEC 61760-1, +260°C for 10 sec.
2002/95/EC (RoHS)	Compliant

*Hermetically-sealed to 1 x 10⁻⁸ cc/sec, On Request

Tooling

WSMP Cable Connector Prybar	W1W001-000
WSMP Right Angle Prybar Extraction Tool	W1W005-000
WSMP Bullet Insertion/ Extraction Tool	W1W002-000
Low Profile	

CABLE CONNECTORS

Description

WSMP Female Straight
for .047 S/R Cable

Part Number

W1K101-270D3

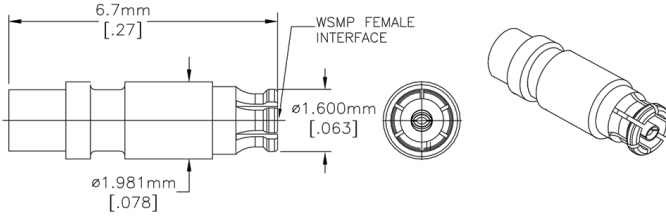

Description

WSMP Female Right Angle
for .047 S/R Cable

Part Number

W1K201-270D3

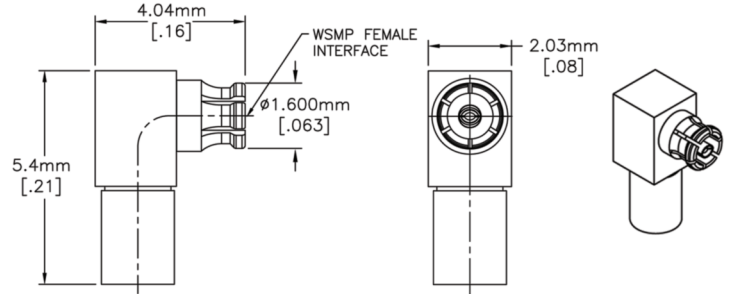

Description

WSMP Male Straight
for .047 S/R Cable

Part Number

FD: W1S101-270D3
SB: W1S141-270D3

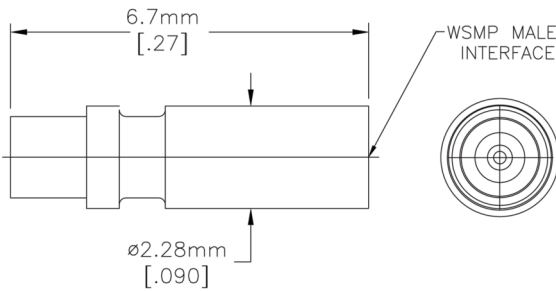

Description

WSMP Male Straight Bulkhead
for .047 S/R Cable

Part Number

FD: W1S501-270D3
SB: W1S541-270D3

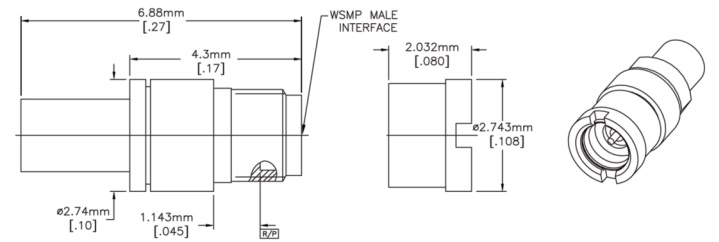

STANDARD

Description

WSMP Male PCB, Straight, SMT, J-Lead

Part Number

FD: W1S105-40ML5
SB: W1S145-40ML5

Hi Temp (Kovar/Glass)

WSMP Male PCB, Straight, SMT, J-Lead

FD: W1S103-40MZ9
SB: W1S143-40MZ9

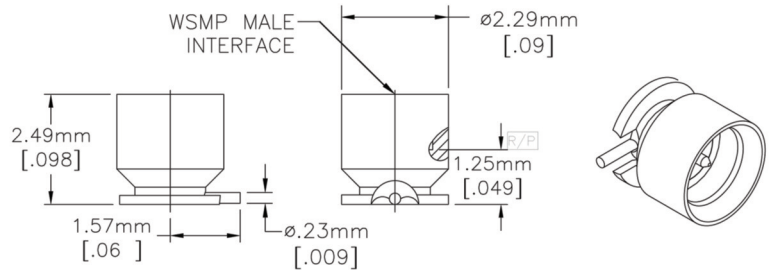

STANDARD

Description

WSMP Male PCB Edge Mount

Part Number

FD: W1S203-40ML5
SB: W1S243-40ML5

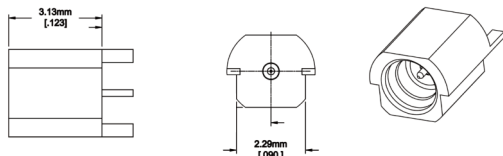

Hi Temp (Kovar/Glass)

WSMP Male PCB Edge Mount

FD: W1S204-40MZ9
SB: W1S244-40MZ9

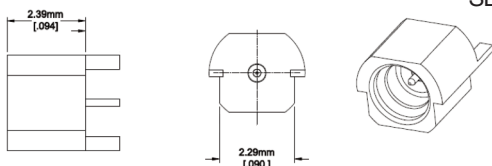

STANDARD

Description

WSMP St Male MultiPort Arrays, SB

Part Number

2 Port: W1S10A-40ML5
4 Port: W1S10B-40ML5

Hi Temp (Kovar/Glass)

WSMP St Male MultiPort Arrays, SB

2 Port: W1S12A-40MZ9
4 Port: W1S12B-40MZ9

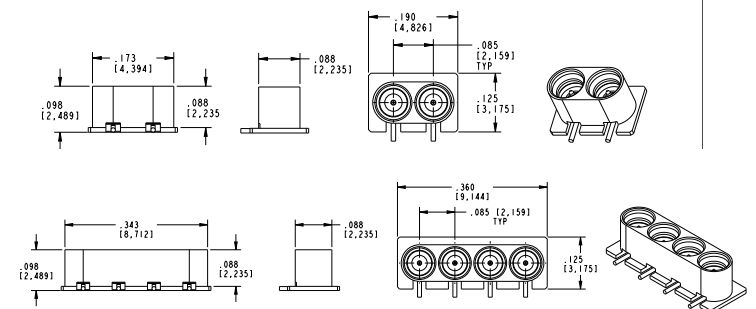

ADAPTERS

Description

WSMP Female Blindmate Interconnect (Bullet)

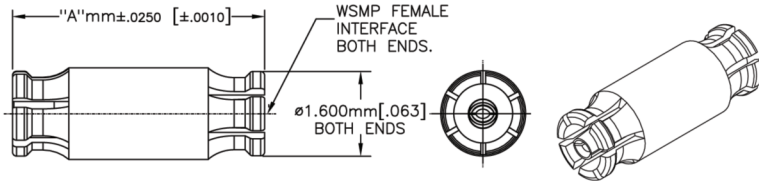

Part Number	A (mm)	A (in)	Part Number	A (mm)	A (in)
W1K10A-K00D3	2.49	0.098	W1K10J-K00D3	7.62	0.300
W1K10C-K00D3	3.18	0.125	W1K10M-K00D3	10.16	0.400
W1K10F-K00D3	3.81	0.150	W1K10N-K00D3	12.70	0.500
W1K10G-K00D3	5.08	0.200	W1K10P-K00D3	15.24	0.600
W1K10H-K00D3	6.35	0.250			

Additional lengths available on request

BETWEEN SERIES TEST ADAPTERS

Description

WSMP Male Full Detent to RPC-2.92 Female Adapter
 RPC-2.40 Female Adapter
 RPC-1.85 Female Adapter

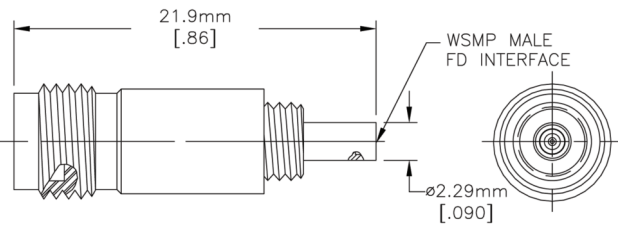

Part Number

W1S102-K00D3 to 40 GHz

W1S109-K00D3 to 50 GHz

W1S108-K00D3 to 67 GHz

BETWEEN SERIES TEST ADAPTERS

Description

WSMP Female to RPC-2.92 Female Adapter
 RPC-2.40 Female Adapter
 RPC-1.85 Female Adapter

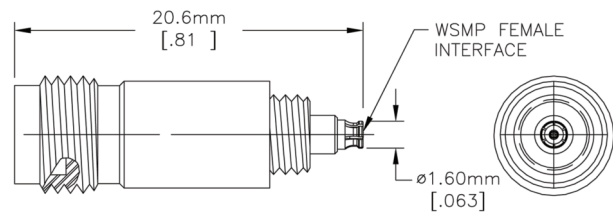

Part Number

W1K102-K00D3 to 40 GHz

W1K109-K00D3 to 50 GHz

W1K108-K00D3 to 67 GHz

TERMINATIONS

Description

WSMP Male 50 Ohm Termination,
 Full Detent, 0.25 W

Part Number
 W1S15T-0.2D3

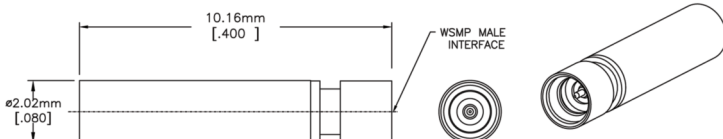

Description

WSMP Female 50 Ohm
 Termination, 0.25 W

Part Number
 W1K15T-0.2D3

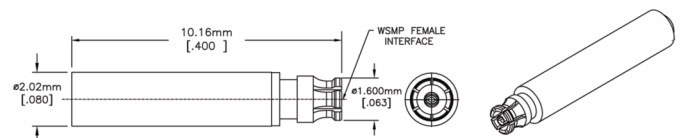

WSMP™ CABLE ASSEMBLIES

Description: WSMP Female Straight on .047 Flexible, Formable, Semi-Rigid to RPC 2.92 Male, RPC 2.40 Male and RPC 1.85 Male

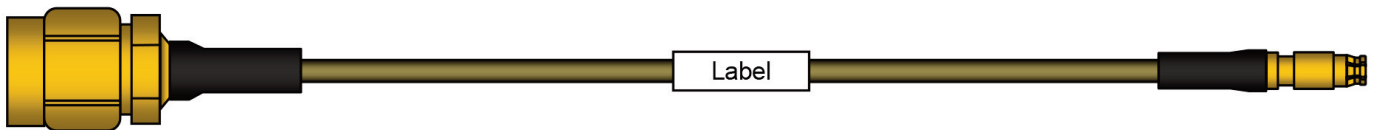
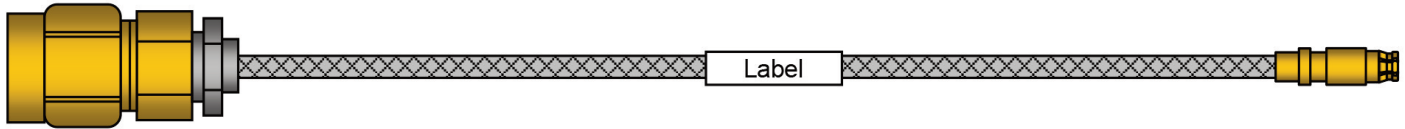

CUSTOM FOR YOUR NEEDS.

TOOLS

Description

WSMP Cable Connector Prybar
Extraction Tool

Part Number
W1W001-000

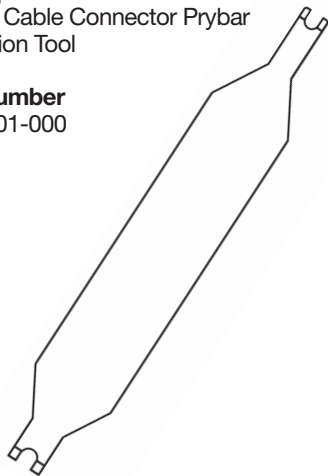

Description

WSMP Right Angle Prybar
Extraction Tool

Part Number
W1W005-000

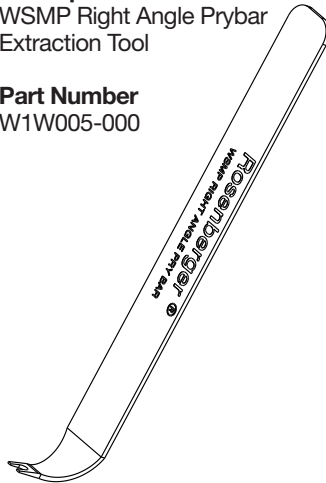

Description

WSMP Bullet Insertion/
Extraction Tool, Low Profile

Part Number
W1W002-000

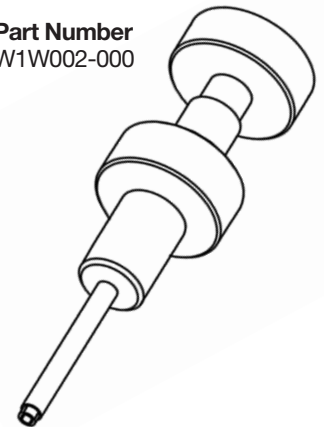

Компания «Life Electronics» занимается поставками электронных компонентов импортного и отечественного производства от производителей и со складов крупных дистрибьюторов Европы, Америки и Азии.

С конца 2013 года компания активно расширяет линейку поставок компонентов по направлению коаксиальный кабель, кварцевые генераторы и конденсаторы (керамические, пленочные, электролитические), за счёт заключения дистрибьюторских договоров

Мы предлагаем:

- Конкурентоспособные цены и скидки постоянным клиентам.
- Специальные условия для постоянных клиентов.
- Подбор аналогов.
- Поставку компонентов в любых объемах, удовлетворяющих вашим потребностям.
- Приемлемые сроки поставки, возможна ускоренная поставка.
- Доставку товара в любую точку России и стран СНГ.
- Комплексную поставку.
- Работу по проектам и поставку образцов.
- Формирование склада под заказчика.
- Сертификаты соответствия на поставляемую продукцию (по желанию клиента).
- Тестирование поставляемой продукции.
- Поставку компонентов, требующих военную и космическую приемку.
- Входной контроль качества.
- Наличие сертификата ISO.

В составе нашей компании организован Конструкторский отдел, призванный помогать разработчикам, и инженерам.

Конструкторский отдел помогает осуществить:

- Регистрацию проекта у производителя компонентов.
- Техническую поддержку проекта.
- Защиту от снятия компонента с производства.
- Оценку стоимости проекта по компонентам.
- Изготовление тестовой платы монтаж и пусконаладочные работы.



Тел: +7 (812) 336 43 04 (многоканальный)
Email: org@lifeelectronics.ru