

INTERCONNECT COMPONENTS & HARDWARE

CATALOG M60.2

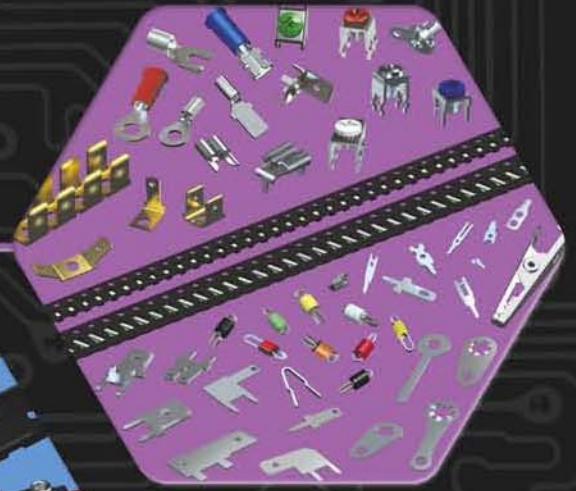
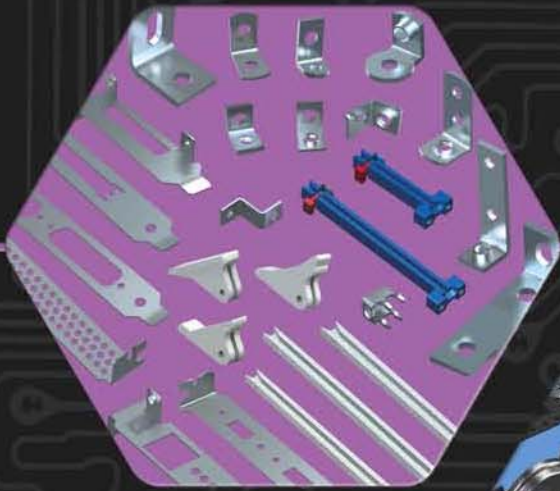

keyelco.com

DESIGNERS AND MANUFACTURERS

RoHS COMPLIANT ~ ISO 9001 CERTIFIED

KEYSTONE
ELECTRONICS CORP.

PRODUCT SPOTLIGHT

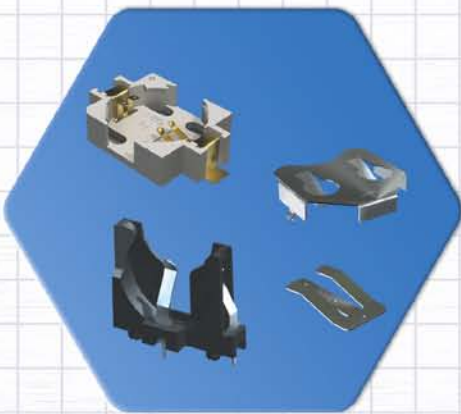

Coin Cell Holders & Retainers
pages 2 - 7



SMT Auto Blade Fuse Clips & Holders
page 41

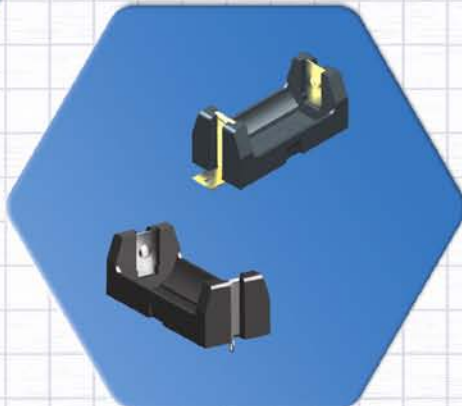

THM & SMT Polarized Holders
page 20

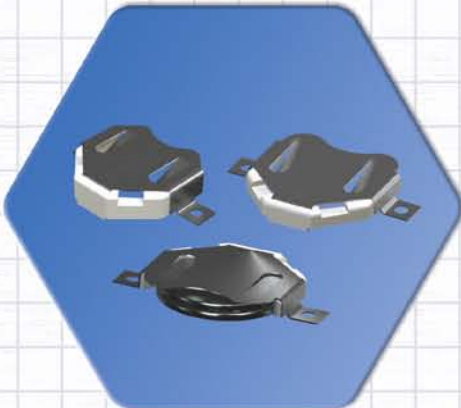

Insulated Coin Cell Retainers
page 4



**Solar Protection Fuse (SPF)
Midget Fuse Holder**
page 43

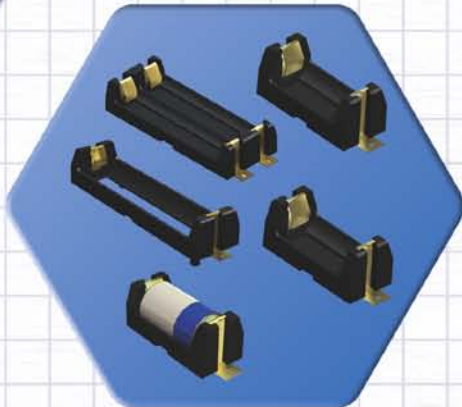

SMT Battery Holders
page 19

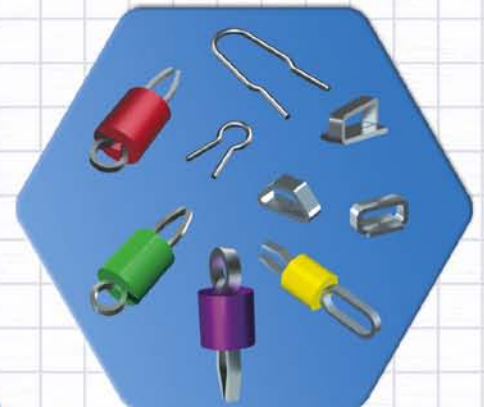

SMT & THM Test Points
page 61

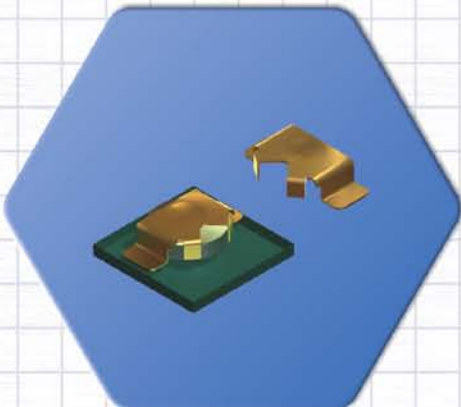

Micro Battery Retainers
page 6

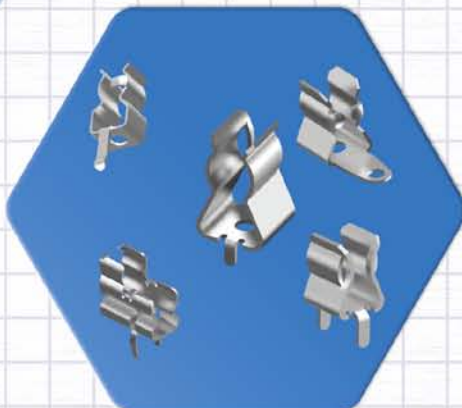

UL Recognized Fuse Clips
pages 44 - 45



Battery Contacts
pages 8 - 16



Color Coded and SEMS Screw Terminals
pages 62 - 65

PRODUCT SPOTLIGHT

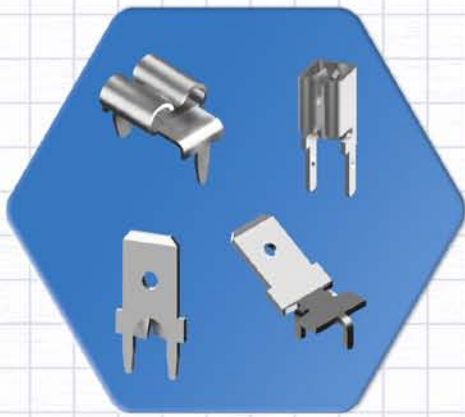

UL Recognized Quick Fit Terminals
pages 52 - 55



**Self-Retaining Mounting Spacers
for T-1 LED's**
page 91

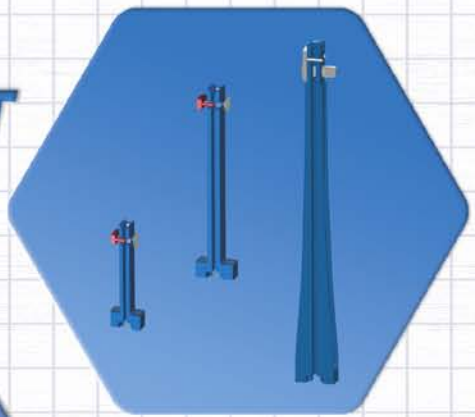

Vertical Card Guides
pages 117

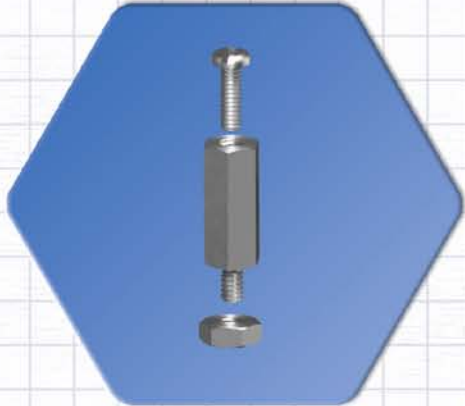

PC/104 - PC/104-Plus Mounting Kits
page 70

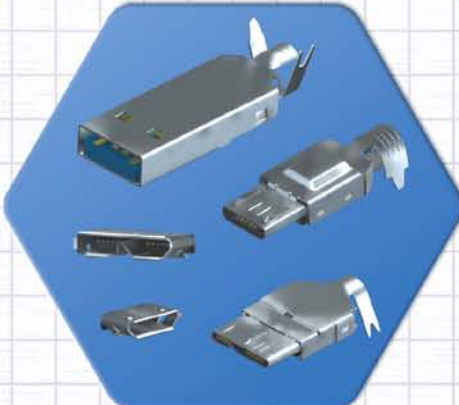

2.0 & 3.0 USB Plugs and Sockets
pages 94 - 97



Anti-Vibration Grommets
page 129



Spacers Supports & Metric Standoffs
pages 76 - 78



Micro Pins & Jacks
pages 98 - 101

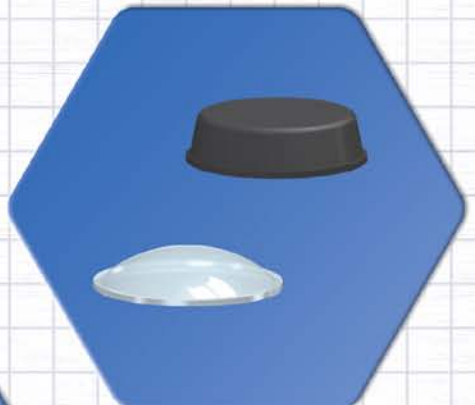

Adhesive Bumpers
page 130

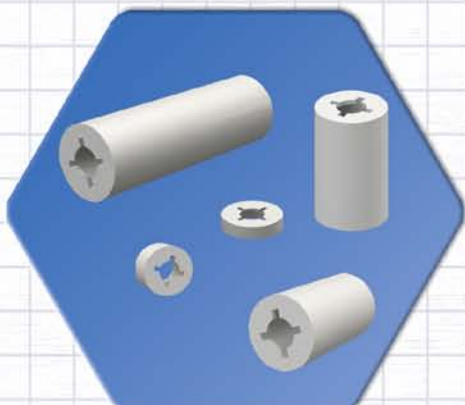

Nylon Self-Retaining Spacers & Washers
page 75 & 131



PTFE Insulated Terminals & Pins
pages 136 - 137

TABLE OF CONTENTS

<p>A</p> <p>ADHESIVE BACKED Bumpers 130 PCB Supports 78</p> <p>ALLIGATOR CLIPS 61</p> <p>AUDIO JACKS 108</p> <p>AUTOMOTIVE BLADE FUZE CLIPS & HOLDERS 38-41</p> <p>B</p> <p>BATTERY CONTACTS & CLIPS Clips/Accessories 8-11 Retainers (Compact Contacts) 4, 6-7 SMT (Surface Mount) 7-8 Snap-On for Plastic Cases 12 Spring 8-10, 12-16 THM (Thru Hole Mount) 7,9,13,29-30</p> <p>BATTERY HOLDERS Aluminum 20-23, 31 Button Cell 6-7 Coin Cell (Lithium) 2-7 Contacts 12-16 Covered, Plastic 27 Interconnect, Steel/Aluminum 21 Lithium 17-20 Lithium-Ion 17, 31 9 Volt 22-23, 31 Plastic 17-20, 26-27, 31 Retainers (Compact Contacts) 4, 6-7 SMT (Surface Mount) 2, 4-5, 17, 19 Steel 20-21, 24-25 Straps 28-29 THM (Thru Hole Mount) 2-5, 7, 17-18, 20-21, 26, 31 Vertical 2-3</p> <p>BATTERY CONTACTS LAYOUT & MOUNTING DETAILS 32-34</p> <p>BATTERY SNAPS & STRAPS 9 VOLT Snap-On 28-30 Straps 28-29</p> <p>BANANA PLUGS & JACKS 106-107</p> <p>BINDING POSTS 108</p> <p>BOARD GUIDES, PC 116-117</p> <p>BRACKETS (Mounting) 114-115</p> <p>BRACKETS (Computer) 118-121</p> <p>BUMPERS, Adhesive Backed 130</p> <p>BUMPERS, Rubber 130</p> <p>BUSHINGS (Nylol/Rubber) 128-129</p> <p>C</p> <p>CABLE TIE ROUTING CLIP 127</p> <p>CABLE CLAMPS 126-127</p> <p>CABLE TIES 127</p> <p>CAPS, LED LENS 90</p> <p>CAPTIVE NUTS 132</p> <p>CAPTIVE SCREWS 83</p> <p>CARD EJECTORS, PC 122</p> <p>CASES (Instrumentation) 85</p> <p>CLIPS Alligator 60 Battery 8-11</p>	<p>C (cont.)</p> <p>Fuse 38-41, 44-45</p> <p>COIN CELL BATTERY Holders (Lithium) 2-7</p> <p>COMPUTER Card Ejectors 122 IEEE 1394 Connectors 97 Jack Screws 82 PC Card Brackets 118-121 USB Connectors 94-96</p> <p>COMPUTER BRACKETS 118-121 Worksheet (Custom Design) 122</p> <p>CONNECTORS F 102 IEEE 1394 97 Mounting Hardware 82-84 Screw Terminals 62-67 USB 94-96</p> <p>CONTACT PINS (Seamless) 123</p> <p>E</p> <p>EYELETS 134</p> <p>EYELET STAKING TOOL 134,135</p> <p>F</p> <p>FAN/FINGER GUARDS 88-89</p> <p>FIBER WASHERS (Flat & Shoulder) 131-132</p> <p>FIREWIRE PLUGS & SOCKETS 97</p> <p>FUZE CLIPS & HOLDERS 38-49 Automotive Blade 38-41 Clips 38-41, 44-45 Covers 43 Holders 38-43 Midget (SPF) 43 Sub-Miniature 43</p> <p>FUZE CONTACTS LAYOUT & MOUNTING DETAILS 46-49</p> <p>G</p> <p>GROMMETS 129</p> <p>GUARDS, FAN/ FINGER 88-89</p> <p>H</p> <p>HALOGEN LAMP SOCKET 11</p> <p>HANDLES, INSTRUMENT 86-87</p> <p>HARDWARE Computer Mounting 82-84 Handle Mounting Screws 87 Nuts / Machine Screws 133 Panel Hardware & Nuts 83-84 Transistor Mounting 109-111</p> <p>HINGED STANDOFFS 75</p> <p>HOLE PLUGS 128</p> <p>I</p> <p>IEEE 1394 (FIRE WIRE) PLUGS& SOCKETS 97</p> <p>INSTRUMENTATION CASES 85</p> <p>INSTRUMENTATION HANDLES 86-87</p> <p>INSULATED COIN CELL RETAINERS 4</p>	<p>I (cont.)</p> <p>INSULATED TERMINALS 136-137</p> <p>INSULATING HARDWARE Bushings 128 Ceramic Standoffs 74 Fiber Washers 131 Mica Insulators 109 Nylon Spacers 74-75 Nylon Washers 131-132 Spacer Supports (Nylon) 76-78 Phenolic Spacers 74</p> <p>INSTALLATION TOOLS Eyelet 134 Quick-Fit 52, 57 Rivet 135 Solder Terminal 135 Staking 73,135</p> <p>J</p> <p>JACKS Audio 108 Banana 107 Insulated 105 Micro 98-99 Phono 102-103 Test 105 Tip 104</p> <p>JACK SCREWS 82</p> <p>K</p> <p>KNOBBS 85</p> <p>L</p> <p>LED HOLDERS 90</p> <p>LED LENS CAPS 90</p> <p>LED SPACER MOUNTS 91 Lugs (Solder) 58</p> <p>M</p> <p>MALE/FEMALE STANDOFFS 70-72 Aluminum, Brass, Nylon, Stainless Steel 70 Metric 72 PC/104 70</p> <p>MICA TRANSISTOR INSULATORS 109</p> <p>MICRO JACKS 98-99</p> <p>MICRO PINS 100-101</p> <p>MIDGET FUZE HOLDER 43</p> <p>MOUNTING BRACKETS 114-115</p> <p>N</p> <p>NYLON CABLE CLAMPS 127</p> <p>NYLON INSULATED SPACER SUPPORTS 76-80</p> <p>NYLON SCREWS 133</p> <p>NYLON SNAP RIVETS 134</p> <p>NYLON SPACERS 74-75</p> <p>NYLON STANDOFFS 70-72</p> <p>NYLON WASHERS (Flat,Shoulder & Retaining) 131-132</p>	<p>P</p> <p>PANEL BEARINGS 84</p> <p>PANEL HARDWARE 83-84</p> <p>PHONO PLUGS & JACKS 102-103</p> <p>PINS Contact (Seamless) 123 Micro 100-101 Wire Wrap (.025 Square) 123</p> <p>PLUGS Banana 106-107 Hole 128 Shorting 101 Solderless 107 Tips & Plugs 104</p> <p>PUSH-IN TERMINALS Flea Clip, Imp, Micro, Solderless, Tubular 123</p> <p>Q</p> <p>QUICK-FIT COMPONENTS Boots 56 Headers 54 PC Mount Female Terminals 55 PC Mount Male Terminals 52-54 Rivet Mount 54 Surface Mount Female Terminals 55</p> <p>QUICK-FIT INSERTION TOOL 52</p> <p>R</p> <p>RIVETS 134</p> <p>RUBBER BUMPERS & GROMMETS 130</p> <p>RETAINING SPACERS 75</p> <p>RETAINING WASHERS 131</p> <p>S</p> <p>SCREWS Colored Head 133 Handle Mounting 87 Jack 82 Machine 133 Metric 133 Panel 83 Self-Tapping 133 Shoulder 84 Thumb 83</p> <p>SCREW TERMINALS 62-67</p> <p>SHAFT LOCKS / EXTENDERS 84</p> <p>SHORTING JACK 101</p> <p>SHORTING PIN 101</p> <p>SHORTING PLUG 101</p> <p>SHOULDER SCREWS 84</p> <p>SMT (Surface Mount Components) Audio Jacks 108 Battery Contacts 6-8 Coin Cell Holders 2-7 Coin Cell Retainers 4, 6-7 Test Points 61</p> <p>SOCKETS Halogen 110 IEEE 1394 97 Micro 98-99</p>
--	--	---	---

TABLE OF CONTENTS (cont.)

S (cont.)

Phono	102-103
Transistor	109-111
USB	94-96
SOLDER LUGS & TERMINALS	58
SOLDER TERMINALS	136-139
SPACERS	
Aluminum, Brass, Nylon, Phenolic	74-75
LED	91
Organizer Kits	79
PC Board (Snap In)	76-78
SQUARE WRAP PINS (.025)	123
STAKING TOOLS	73,135
STANDOFFS	
Aluminum, Brass, Ceramic, Flame Retardant, Nylon, Phenolic, Stainless Steel	70-74
Hinged	75
Metric	72
Organizer Kits	79
PC/104	70
STURDI-MOUNT QUICK-FIT TERMINALS	52-53
T	
TAPE & REEL COMPONENTS	
Audio Jacks	108
Battery Contacts	8
Coin Cell Holders	2, 4-5
Coin Cell Retainers	4, 6-7
Firewire Sockets	97
Fuse Clips	40-41
Fuse Holders	41
Test Points	61
USB Plugs & Sockets	94-96
TERMINAL BOARDS	
Military	141
Screw	143
Scored	140
Turret Terminal	140-142
Quick-Fit	142
TERMINALS	
Boards	140-143
Insulated	136-137
Lugs (Solder)	58
Male/Female, Quick-Fit	52-55
Micro	98-99
Push In	123
Screw	62-67
Solder (Standardized/Turret)	138-139
Solderless	56-57
Strips	143
Sturdi-Mount, Quick-Fit	52-55
Test Points	59-61
TERMINAL STRIPS	
Binding Post (Screw Terminal)	143
Standard & Miniature	143
TEST JACKS	104-105
TEST POINTS	
Color Keyed	60
PC Mount	59-60

T (cont.)

Surface Mount	61
Ultra Low Profile	60
TEST TIPS & PLUGS	104-105
THUMB SCREWS	83
TIP JACKS	104-105
TRANSISTOR COVERS	110
TRANSISTOR SOCKETS/MOUNTS	109-111
TRANSISTOR SOCKET MOUNTING KITS	109,111
TURNABLE JACK SCREWS	82
U	
USB PLUGS & SOCKETS	94-96
V	
VERTICAL COIN CELL HOLDERS	2-3
VIBRATION (ANTI) GROMMETS	129
W	
WASHERS	
Fibre (Flat & Shoulder)	131-132
Nylon (Flat & Shoulder)	131-132
Retaining	131
WORKSHEETS (Custom)	
Computer Brackets	122

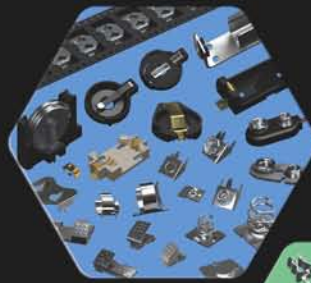

BATTERY CLIPS, CONTACTS & HOLDERS
PAGE 2



FUSE CLIPS & HOLDERS
PAGE 38



TERMINALS & TEST POINTS
PAGE 49



SPACERS & STANDOFFS
PAGE 70



PANEL HARDWARE
PAGE 82



PINS, PLUGS, JACKS & SOCKETS
PAGE 94

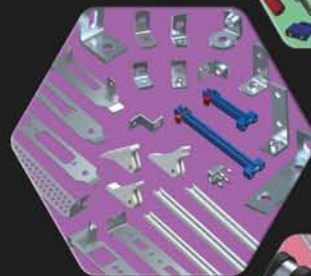

PC BOARD HARDWARE
PAGE 114



MULTI-PURPOSE HARDWARE
PAGE 126

THIS DOCUMENT IS THE PROPERTY OF KEYSTONE ELECTRONICS CORP. AND SHALL NOT BE REPRODUCED, DISTRIBUTED OR USED AS A BASIS FOR MANUFACTURE WITHOUT PRIOR WRITTEN PERMISSION FROM KEYSTONE ELECTRONICS CORP.

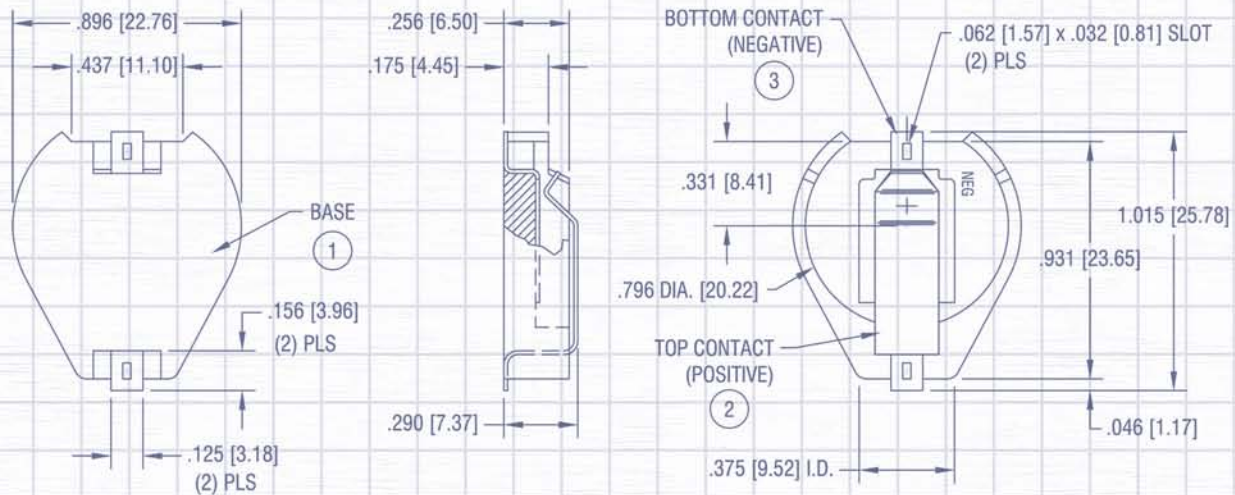
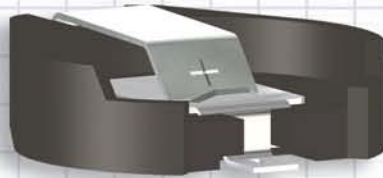
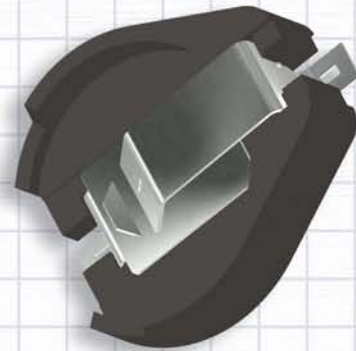
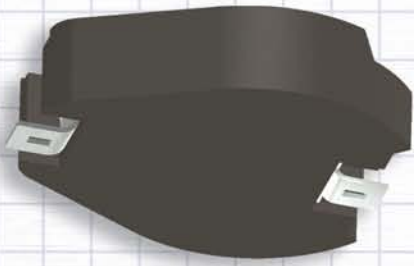

BATTERY CLIPS, CONTACTS & HOLDERS

Our battery clips, contacts and holders are designed with leading edge technology in mind, to accommodate all major manufacturers' batteries. Available in a wide range of materials and mounting styles including surface mount, thru hole and off board, some of the applications include:

- Telecommunications and Video power back-up
- Laptop and mobile computing applications
- Communication system's power requirements
- Microcomputer and memory hold
- Preprogrammed electronic and video games
- Emergency power systems
- Industrial and commercial security and alarm systems
- Miniature battery power devices
- Computer memory, power transfer and back-up systems
- Personal medical monitoring devices

Our quality system is ISO 9001:2008 certified. Our products are in compliance with the RoHS and REACH directives. We provide 3D modeling, CAD and other application-engineering support for modifications, special designs or assembly requirements to assist you in choosing the right Keystone product for your application.

DATE

DESCRIPTION

REV.

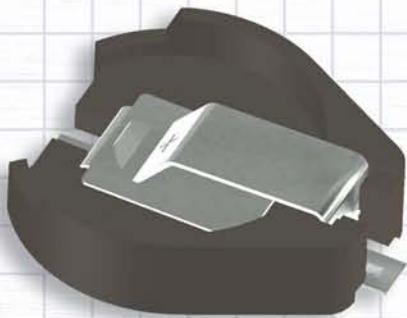

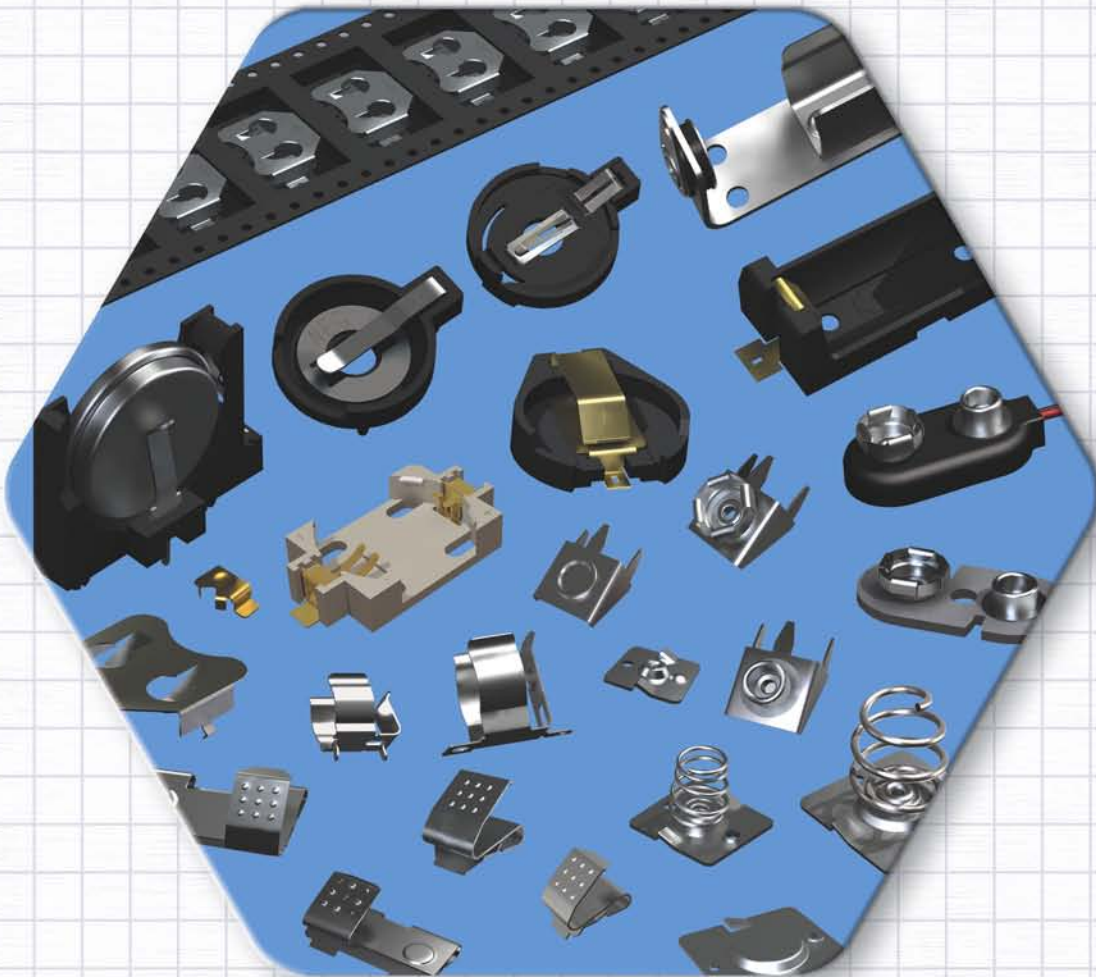

SECTION CONTENTS

RETAINERS

Button Cell	6
Coin Cell	7
Negative Contacts	7

CLIPS/CONTACTS

Alkaline & Lithium, Rivet	10
Alkaline & Lithium, PC	8-9
Battery Clips (no contact)	11
Molded Case	12-16
9 Volt	30

HOLDERS

Aluminum	21-23
Coin Cell	2-7
Lithium Cell	20
PC Mount	18-19
Plastic	26-27
Steel	24-25
9 Volt	31
9 Volt Straps	28-29
18650 Rechargeable	17
MOUNTING DETAILS	32-35

THRU-HOLE (THM) & SURFACE MOUNT (SMT) COIN CELL HOLDERS

12mm to 16mm COIN CELL HOLDERS

DESIGN ADVANTAGES...

- Reliable spring tension assures low contact resistance
- Retains battery securely to withstand shock and vibration
- Base material UL Rated 94V-0. Impervious to most industrial solvents
- Operating temperature range: -60°F to +293°F (-50°C to +145°C)

IDEALLY SUITED FOR...

- Computer memory, power transfer and back-up systems
- Video and telecommunications power back-up
- Microprocessors and Microcomputer memory hold (desktop and laptop applications)
- Industrial and commercial security and alarm systems
- PC/104 application



THRU HOLE MOUNT

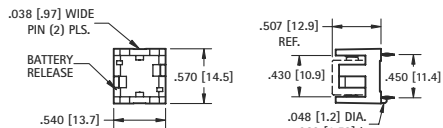

1/3N

AVAILABLE ON TAPE AND REEL

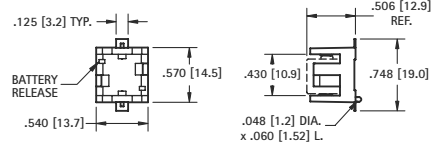

SURFACE MOUNT

MATERIAL:

Base: High Temperature Nylon 46, UL Rated 94V-0
Contacts: .012 (.30) Phosphor Bronze, Tin Plate

CAT. NO.	CELLS	BATTERY REFERENCE
503	1	DL1/3N, K58L, CR1/3N
	2	SR44, 357, MS76, G-13, 303, V313, PX76A

Mounting Detail

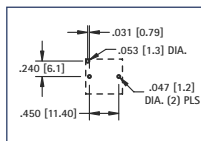

MATERIAL:

Base: High Temperature Nylon 46, UL Rated 94V-0
Contacts: .012 (.30) Phosphor Bronze, Gold Plate (Flash)

CAT. NO. BULK	ON TAPE & REEL	CELLS	BATTERY REFERENCE
498	498TR	1	DL1/3N, K58L, CR1/3N
		2	SR44, 357, MS76, G-13, 303, V313, PX76A

Pad Layout

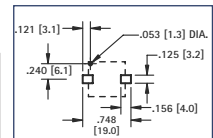

Tape & Reel Specs: 44mm wide; 20mm pitch; 13 inch reel (200 pieces per reel)



THRU HOLE MOUNT

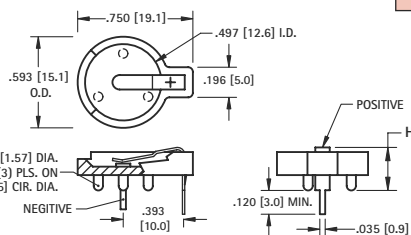

12mm

AVAILABLE ON TAPE AND REEL

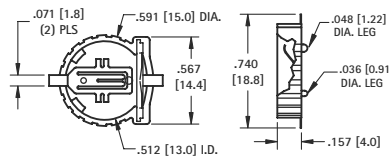

SURFACE MOUNT

MATERIAL:

Base: PBT, UL Rated 94V-0
Positive Contact: .015 (.38) Spring Steel, Tin-Nickel Plate
Negative Contact: .035 (.89) Dia. Steel, Tin-Nickel Plate

CAT. NO.	HEIGHT (H)	CELLS	BATTERY REFERENCE
500	.280 (7.1)	1	BR1212, CR1216, CL1220, CR1225
501	.380 (9.7)	2	BR1212, CR1216, CL1220, CR1225

Mounting Detail

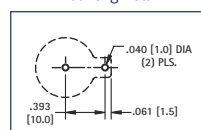

MATERIAL:

Base: Glass Filled PPS, UL Rated 94V-0
Contacts: .008 (.20) Phosphor Bronze, Gold Plate (Flash)

CAT. NO. BULK	ON TAPE & REEL	CELLS	BATTERY REFERENCE
1056	1056TR	1	CR1220, BR1220

Pad Layout

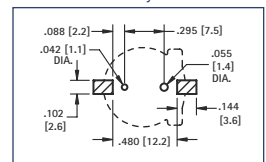

Tape & Reel Specs: 32mm wide; 20mm pitch; 13 inch reel (500 per reel)



THRU HOLE MOUNT

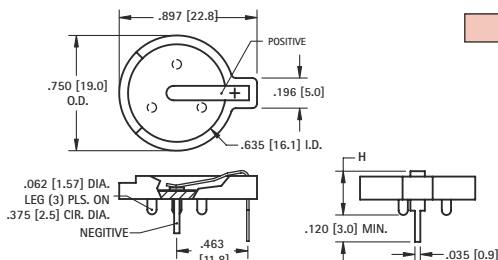

16mm

AVAILABLE ON TAPE AND REEL

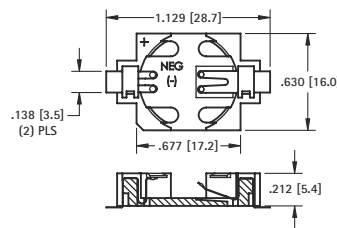

SURFACE MOUNT

MATERIAL:

Base: Glass Filled LCP, UL Rated 94V-0
Positive Contact: .015 (.38) Spring Steel, Tin-Nickel Plate
Negative Contact: .035 (.89) Dia. Steel, Tin-Nickel Plate

CAT. NO.	HEIGHT (H)	CELLS	BATTERY REFERENCE
502	.285 (7.3)	1	CR1612, CL1616, CL1620
		2	CR1612
502-3	.330 (8.4)	1	BR1625, CR1632
		2	BR1616, CR1620, CL1620

Mounting Detail

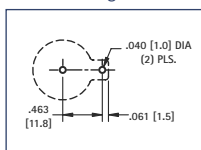

MATERIAL:

Base: Glass Filled LCP, UL Rated 94V-0
Contacts: .006 (.15) Phosphor Bronze, Gold Plate (Flash)

CAT. NO. BULK	ON TAPE & REEL	CELLS	BATTERY REFERENCE
504	504TR	1	BR1625, CR1632

Pad Layout

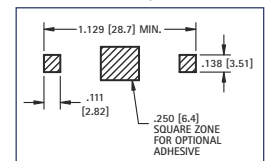

Tape & Reel Specs: 44mm wide; 24mm pitch; 13 inch reel (450 per reel)

16mm VERTICAL

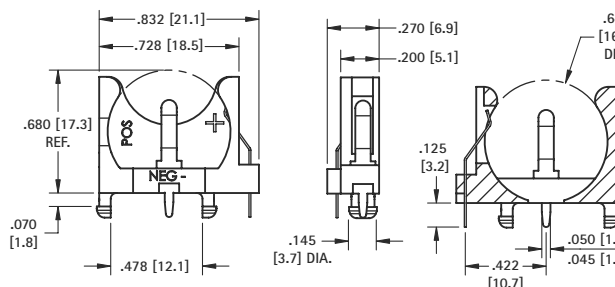

Pad Layout

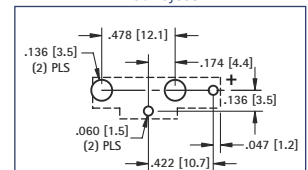

MATERIAL:

Base: PBT, UL Rated 94V-0
Contacts: .010 (.25) Steel, Tin-Nickel Plate
Battery Reference: (1) cell: BR1612, CR1616, CL1620, CR1625, BR1632

CAT. NO. 1069

20mm THRU-HOLE MOUNT COIN CELL HOLDERS



- Advanced air-flow design enhances air circulation around battery
- Reliable spring tension assures low contact resistance
- Unique notched slots assure quick and easy battery insertion and replacement
- Retains battery securely to withstand shock and vibration
- PBT base material UL rated 94V-0. Impervious to most industrial solvents
- Operating temperature range: -60°F to +293°F (-50°C to +145°C)

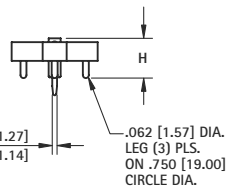
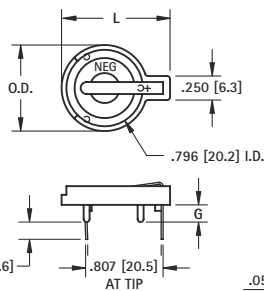

- **Cat. No. 101** is designed to maximize PC Board Capacity
- Unique raised mounting design allows components to be placed underneath the holder
- Ideal when board space is more important than board height; such as PC/104 applicatons

MATERIAL:

Contacts: .020 (.50) Spring Steel, Tin-Nickel Plate
Base: PBT, UL Rated 94V-0

CAT. NO.	G	H	L	O.D.	NO. OF CELLS	BATTERY REFERENCE
103	.100 (2.5)	.335 (8.5)	1.130 (28.7)	.896 (22.8)	(1) cell (any 20mm) (2) 2012, (2) 2016	BR2012, CR2012, CR2016, CL2016, DL2020, CL2025, BR2025, CR2032, CL2032
101	.179 (4.6)	.414 (10.5)	1.130 (28.7)	.896 (22.8)	(1) cell (any 20mm) (2) 2012, (2) 2016	BR2012, CR2012, CR2016, CL2016, DL2020, CL2025, BR2025, CR2032, CL2032
106	.100 (2.5)	.335 (8.5)	1.219 (31.0)	1.093 (27.8)	(1) cell (any 20mm) (2) 2012, (2) 2016	BR2012, CR2012, CR2016, CL2016, DL2020, CL2025, BR2025, CR2032, CL2032
1026	.100 (2.5)	.452 (11.5)	1.219 (31.0)	1.093 (27.8)	(2) 2020, (2) 2025, (2) 2032	DL2020, CR2020, CL2025, BR2025, CR2032, CL2032

Mounting Detail

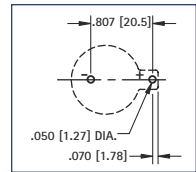

TOP LOADING



- Battery "Pop-in" from top for compact applications
- Finger pressure against lever will release battery
- No tools required for battery changes

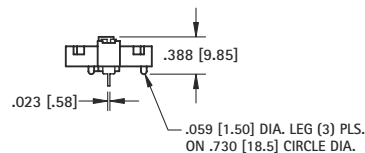
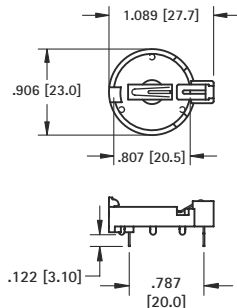

Mounting Detail

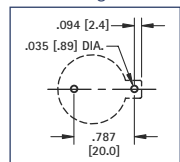

MATERIAL:

Contacts: .016 (.40) Phosphor Bronze, Tin Plate
Base: Nylon UL Rated 94V-0

CAT. NO.	BATTERY REFERENCE
1066	BR2025, CR2032

VERTICAL COMPACT

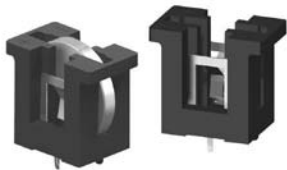

MATERIAL:

Contacts: .012 (.30) Spring Steel, Tin-Nickel Plate
Base: PBT, UL Rated 94V-0

CAT. NO.	BATTERY REFERENCE
1067	CR2016, DL2020, CL2025, CR2032

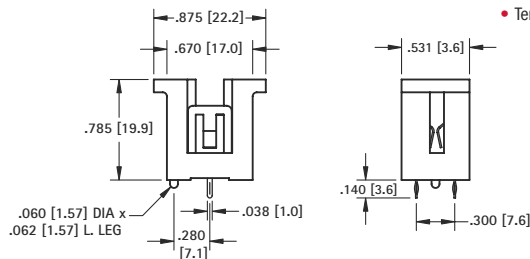

- Accepts all major manufacturers' 20mm diameter batteries
- Molded notch prevents improper insertion of 2032 size cells
- Retains cells securely, withstands shock and vibration
- Polarity clearly marked
- Mounts securely for wave soldering
- Temperature range: -60°F to +293°F (-50°C to +145°C)

Mounting Detail

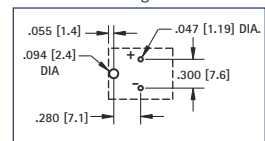

VERTICAL SLIMLINE

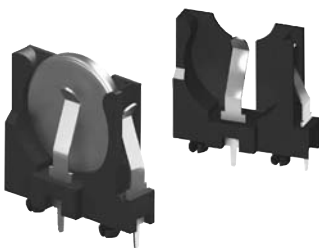

MATERIAL:

Contacts: .016 (.40) Spring Steel, Tin-Nickel Plate
Base: PBT, UL Rated 94V-0

CAT. NO.	BATTERY REFERENCE
1065	BR2012, CR2016, DL2020, CL2025, CR2032

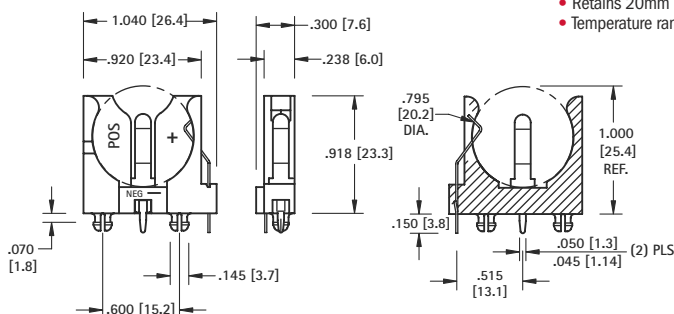

- Polarized holder
- Mounts securely for wave soldering
- Reliable spring tension assures low contact resistance
- Retains 20mm batteries securely to withstand shock and vibration
- Temperature range -60°F to +293°F (-50°C to +145°C)

Mounting Detail

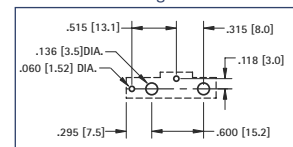

THRU-HOLE (THM) & SURFACE MOUNT (SMT) COIN CELL HOLDERS

20mm COIN CELL HOLDERS

DESIGN ADVANTAGES...

- Reliable spring tension assures low contact resistance
- Retains battery securely to withstand shock and vibration
- All conductive polystyrene carrier tape meets ANSI/EIA - 481 standard

- Base material UL Rated 94V-0. Impervious to most industrial solvents
- Operating temperature range: -60°F to +293°F (-50°C to +145°C)

IDEALLY SUITED FOR...

- Computer memory, power transfer and back-up systems
- Video and telecommunications power back-up
- Microprocessors and Microcomputer memory hold (desktop and laptop applications)
- Industrial and commercial security and alarm systems
- Communications power sources
- PC/104 applications

20mm CELLS



- Polarity clearly marked (+)
- Compatible with vacuum and mechanical pick & place assembly systems
- Low profile for high density packaging
- Rugged construction, light weight
- SMT solder tail with "Flow-Hole" design for increased joint strength
- Viewable solder tails assures reliable joint inspection
- Safe for all soldering & reflow operations

MATERIAL:

Contacts: .015 (.38) Steel
Base: High Temperature, Nylon 46, UL Rated 94V-0

Tin-Nickel Plate		Gold Plate (Flash)		D PAD SIZE	H HEIGHT	CELLS	BATTERY REFERENCE
CAT. NO. BULK	ON TAPE & REEL	CAT. NO. BULK	ON TAPE & REEL				
1061	1061TR	1081	1081TR	.156 (4.0)	.290 (7.4)	(1) Cell (any 20mm)	CR2012, CL2016, BR2020, DL2032 CR2032
1063	1063TR	1093	1093TR	.278 (7.1)		(2) 2012, (2) 2016	
1062	1062TR	1082	1082TR	.156 (4.0)	.391 (9.9)	(2) 2020, (2) 2025, (2) 2032	
1064	1064TR	1094	1094TR	.278 (7.1)		(3) 2012, (3) 2016	

Tape & Reel Spec's: 44mm wide; 32mm pitch; 13 inch reel (200 pieces per reel)

AVAILABLE ON TAPE AND REEL

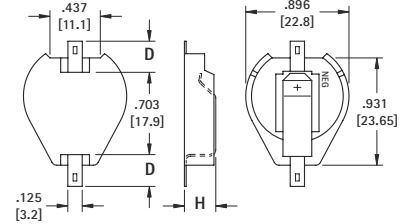

Pad Layout

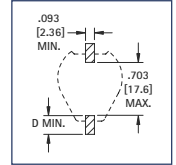

AVAILABLE ON TAPE AND REEL

2025 / 2032 CELL

- Polarized Holders
- Low Profile for high density packaged PCB's
- Vertical entry



Surface Mount

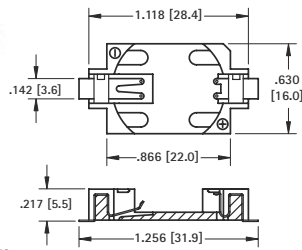

- Compatible with vacuum and mechanical pick & place assembly systems

MATERIAL:

Contacts: .006 (.15) Phosphor Bronze, Gold Plate (Flash)
Base: Glass Filled LCP, UL Rated 94V-0

CAT. NO. BULK	ON TAPE & REEL	BATTERY REFERENCE
1060	1060TR	CR2025, DL2032

Tape & Reel Spec's: 44mm wide; 24mm pitch; 13 inch reel (500 pieces per reel)

Pad Layout

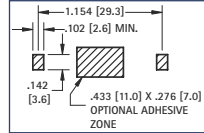

Mounting Detail

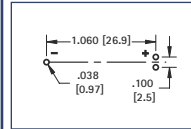

MATERIAL:

Contacts: .006 (.15) Phosphor Bronze, Tin Plate
Base: Glass Filled LCP, UL Rated 94V-0

CAT. NO.	BATTERY REFERENCE
1059	CR2025, DL2032



Thru Hole Mount

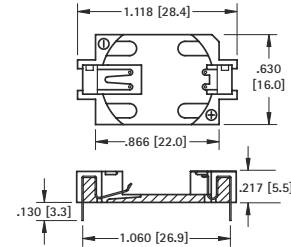

INSULATED RETAINERS

AVAILABLE ON TAPE AND REEL

20mm CELLS

- Ideal for 6 volt or 3 volt applications
- Two coin cell batteries can be installed in series
- Plastic insulator prevents shorting of battery, within the holder, when installed improperly
- Low profile
- Battery release ports for easy battery replacement
- Refer to pages 6 & 7 for a complete offering of coin cell retainers

MATERIAL: Contacts: .010 (.25) Phosphor Bronze **Insulator:** High Temperature, Nylon 46, UL Rated 94V-0



Surface Mount

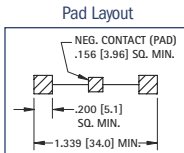
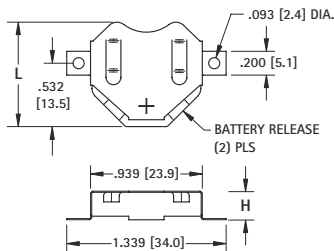

Thru Hole Mount

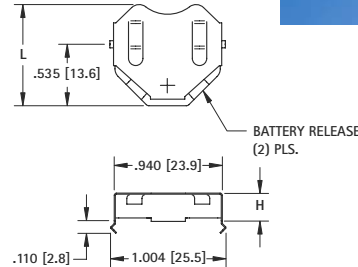

Mounting Detail

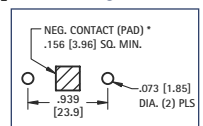

Surface Mount						BATTERY REFERENCE				Thru Hole Mount			
Tin-Nickel Plate			Matte Tin Plate			6 VOLT (2) CELLS		3 VOLT (1) CELL		Tin-Nickel Plate			
CAT. NO. LOOSE*	CAT. NO. BULK	ON TAPE & REEL	CAT. NO. LOOSE*	CAT. NO. BULK	ON TAPE & REEL	L	H	L	H	CAT. NO. LOOSE*	CAT. NO. BULK		
3020-2	3020	3020TR	3070-2	3070	3070TR	.890 (22.6)	.156 (4.0)	2012, 2016	2020, 2025	.890 (22.6)	.156 (4.0)	3021-2	3021
3022-2	3022	3022TR	3072-2	3072	3072TR	.877 (22.3)	.240 (6.1)	2020, 2025	2032	.877 (22.3)	.240 (6.1)	3023-2	3023
3024-2	3024	3024TR	3074-2	3074	3074TR	.877 (22.3)	.295 (7.5)	2032	Not Applicable	.877 (22.3)	.295 (7.5)	3025-2	3025

* Supplied Unassembled

Tape & Reel Spec's: 56mm wide; 28mm pitch; 13 inch reel: 3020TR, 3070TR 400 pieces per reel; 3022TR, 3072TR 250 pieces per reel; 3024TR, 3074TR 250 pieces per reel

THRU-HOLE (THM) & SURFACE MOUNT (SMT) COIN CELL HOLDERS

23mm

AVAILABLE ON TAPE AND REEL

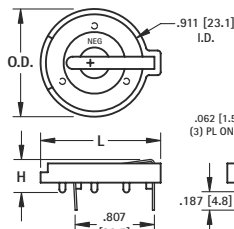

- Polarity clearly marked (+)
- Rugged construction, light weight
- SMT solder tail with "Flow-Hole" design for increased joint strength
- Viewable solder tails assures reliable joint inspection
- Safe for all soldering & reflow operations
- Compatible with vacuum and mechanical pick & place assembly systems

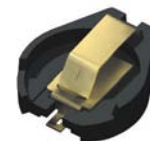

Surface Mount

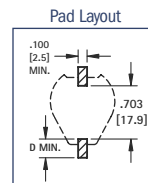
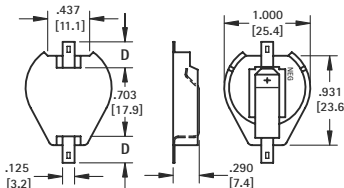

MATERIAL:

Contacts: .020 (.50) Spring Steel, Tin-Nickel Plate

Base: PBT, UL Rated 94V-0

Operating Temperature: -60°F to +293°F (-50°C to +145°C)

CAT. NO.	H	L	O.D.	NO. OF CELLS	BATTERY REFERENCE
104	.335 (8.5)	1.150 (29.2)	1.000 (25.4)	(1) Cell (Any 23mm)	BR2320, CR2320, CL2325, DL2330, CL2354, CR2335
107	.335 (8.5)	1.219 (31.0)	1.093 (27.8)	(1) Cell (Any 23mm) (1) 2354	
1027	.452 (11.5)	1.219 (31.0)	1.093 (27.8)	(2) 2320, (2) 2325, (2) 2330	

MATERIAL:

Contacts: .015 (.38) Steel

Base: High Temp Nylon 46, UL Rated 94V-0

Operating Temperature: -60°F to +293°F (-50°C to +145°C)

Tin-Nickel Plate		Gold Plate (Flash)		D PAD SIZE	BATTERY REFERENCE
CAT. NO. BULK & REEL	CAT. NO. BULK & REEL	CAT. NO. BULK & REEL	CAT. NO. BULK & REEL		
1071	1071TR	1091	1091TR	.156 (4.0)	CR2320, CL2325,
1073	1073TR	1083	1083TR	.278 (7.1)	DL2330, CR2335

Tape & Reel Spec's: 44mm wide; 32mm pitch; 13 inch reel, (200 pieces per reel)

Note: All conductive polystyrene carrier tape meets ANSA/EIA - 481 standard

24mm

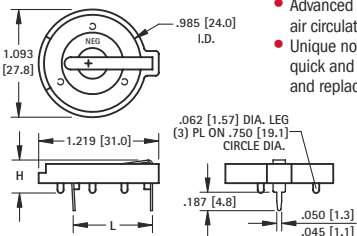

- Advanced air-flow design enhances air circulation around battery
- Unique notched slots assure quick and easy battery insertion and replacement

- Polarized holder
- Mounts securely for wave soldering
- Reliable spring tension assures low contact resistance



Thru Hole Mount

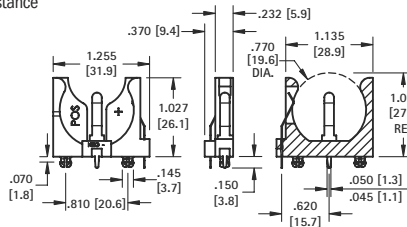

MATERIAL:

Base: PBT, UL Rated 94V-0

Contacts: .020 (.50) Spring Steel, Tin-Nickel Plate

Operating Temperature: -60°F to +293°F (-50°C to +145°C)

CAT. NO.	C	H	L	NO. OF CELLS	BATTERY REFERENCE
105	.064 (1.6)	.335 (8.5)	.805 (20.5)	(1) 2430	CR2430, CL2430, BR2450, CR2477
1025	.074 (1.9)	.452 (11.5)	.805 (20.5)	(1) 2450 (2) 2430	
1025-7	.074 (1.9)	.503 (12.8)	.805 (20.5)	(1) 2477 (2) 2430	

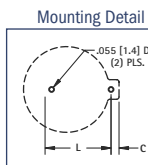

MATERIAL:

Base: PBT, UL Rated 94V-0

Contacts: .020 (.50) Spring Steel, Tin-Nickel Plate

Operating Temperature: -60°F to +293°F (-50°C to +145°C)

CAT. NO.	BATTERY REFERENCE
1068	(1) CR2450, (1) CL2450

Mounting Detail

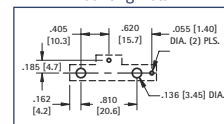

24mm TOP Loading

AVAILABLE ON TAPE AND REEL

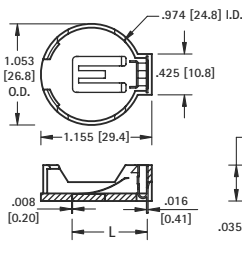

- Battery "Pop-in" from top for compact designs
- No tools required
- Finger pressure battery release

- Polarized holder
- Low profile for densely packed PCB's
- Compatible with vacuum and mechanical pick & place systems
- Conductive carrier tape meets ANSA/EIA - 481 standard



Surface Mount

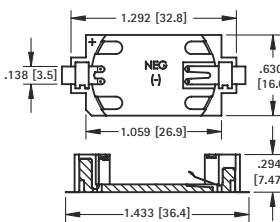

MATERIAL:

Contacts: Phosphor Bronze, Nickel Plate

Base: High Temp Nylon 46, UL Rated 94V-0

Operating Temperature: -60°F to +293°F (-50°C to +145°C)

CAT. NO.	L	C	BATTERY REFERENCE
1053	.788 (20.0)	.048 (1.2)	(1) CR2450

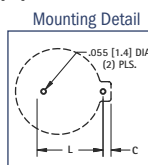

MATERIAL:

Base: LCP, UL Rated 94V-0

Contacts: .020 (.50) Spring Steel, Tin-Nickel Plate

Operating Temperature: -60°F to +293°F (-50°C to +145°C)

CAT. NO. BULK & REEL	ON TAPE & REEL	BATTERY REFERENCE
1052	1052TR	(1) CR2450

Tape & Reel Spec's: 56mm wide; 24mm pitch; 13 inch reel, (250 pieces per reel)

Mounting Detail

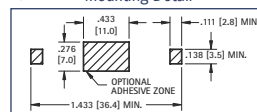

30mm

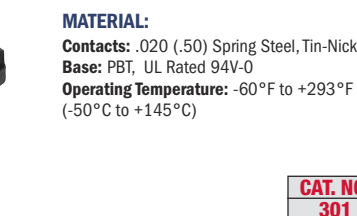

MATERIAL:

Contacts: .020 (.50) Spring Steel, Tin-Nickel Plate

Base: PBT, UL Rated 94V-0

Operating Temperature: -60°F to +293°F (-50°C to +145°C)

CAT. NO.	BATTERY REFERENCE
301	BR3032

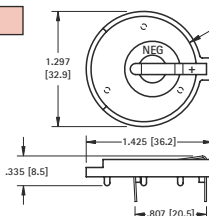

Mounting Detail

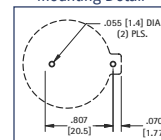

THRU HOLE (THM) & SURFACE MOUNT (SMT) BUTTON CELL RETAINERS

Economical and reliable SMT and THM coin cell retainers specifically designed for miniature electronic applications with limited board space.

- Available in Thru Hole Mount (THM) or Surface Mount (SMT) configurations
- THM legs maintain relative position during and after soldering
- Retains battery securely to withstand shock and vibration
- SMT solder tail with "flow-hole" design for increased joint strength
- Ideally suited for High Density packaging
- Solder tail located outside of retainer body which facilitates visual inspection of the solder joints
- Reliable spring tension assures low contact resistance

4 mm to 12 mm BUTTON CELL RETAINERS

AVAILABLE ON TAPE AND REEL

4.8 mm



Surface Mount

MATERIAL: .006 (.15) Phosphor Bronze, Gold Plate (Flash)

CAT. NO. BULK	ON TAPE & REEL	FINISH	BATTERY REFERENCE
2994	2994TR	Tin-Nickel	ML414
		Matte Tin	

Tape & Reel Spec's: 16mm wide; 8mm pitch; 13 inch reel (1500 pieces per reel)

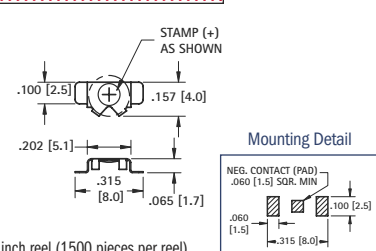

Mounting Detail

AVAILABLE ON TAPE AND REEL

4.8 mm



Thru Hole Mount

MATERIAL: .006 (.15) Phosphor Bronze, Tin-Nickel Plate

CAT. NO.	BATTERY REFERENCE
2995	ML414

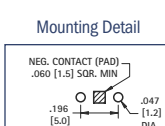

Mounting Detail

AVAILABLE ON TAPE AND REEL

6.8 mm



Surface Mount

MATERIAL: .010 (.25) Phosphor Bronze

CAT. NO. BULK	ON TAPE & REEL	FINISH	BATTERY REFERENCE
2998	2998TR	Tin-Nickel	MC621, V364, SC621, DR13H, V13AT
3098	3098TR	Matte Tin	

Tape & Reel Spec's: 24mm wide; 12mm pitch; 13 inch reel (1000 pieces per reel)

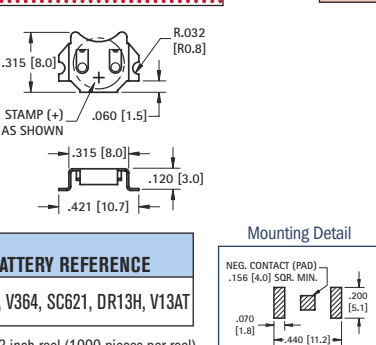

Mounting Detail

AVAILABLE ON TAPE AND REEL

6.8 mm



Thru Hole Mount

MATERIAL: .010 (.25) Phosphor Bronze, Tin-Nickel Plate

CAT. NO.	BATTERY REFERENCE
2999	MC621, V364, SC621

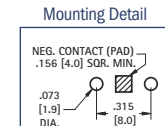

Mounting Detail

AVAILABLE ON TAPE AND REEL

7.9 mm

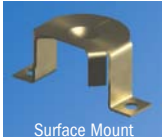

Surface Mount

MATERIAL: .010 (.25) Phosphor Bronze, Gold Plate (Flash)

CAT. NO. BULK	ON TAPE & REEL	FINISH	BATTERY REFERENCE
2988	2988TR	Size 13, DA13, AZ13E	

Tape & Reel Spec's: 24mm wide; 12mm pitch; 13 inch reel (800 pieces per reel)

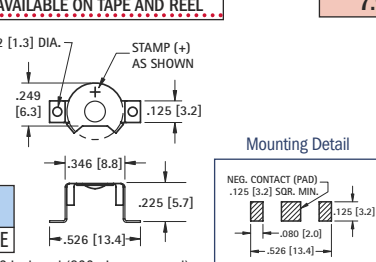

Mounting Detail

AVAILABLE ON TAPE AND REEL

7.9 mm



Thru Hole Mount

MATERIAL: .010 (.25) Phosphor Bronze, Tin-Nickel Plate

CAT. NO.	BATTERY REFERENCE
2989	Size 13, DA13, AZ13E

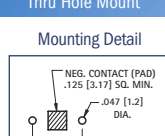

Mounting Detail

AVAILABLE ON TAPE AND REEL

9 - 10 mm



Surface Mount

MATERIAL: .006 (.15) Phosphor Bronze, Tin-Nickel Plate

CAT. NO. BULK	ON TAPE & REEL	FINISH	BATTERY REFERENCE
3030	3030TR	Tin-Nickel	CR927, CR1025
3050	3050TR	Matte Tin	

Tape & Reel Spec's: 24mm wide; 12mm pitch; 13 inch reel (1500 pieces per reel)

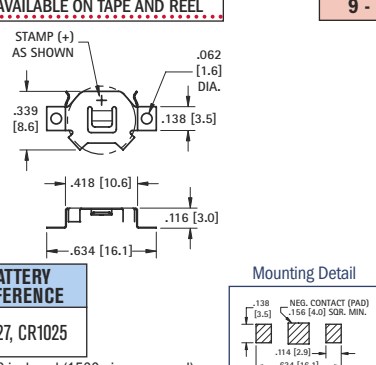

Mounting Detail

AVAILABLE ON TAPE AND REEL

9 - 10 mm



Thru Hole Mount

MATERIAL: .006 (.15) Phosphor Bronze, Tin-Nickel Plate

CAT. NO.	BATTERY REFERENCE
3031	CR927, CR1025

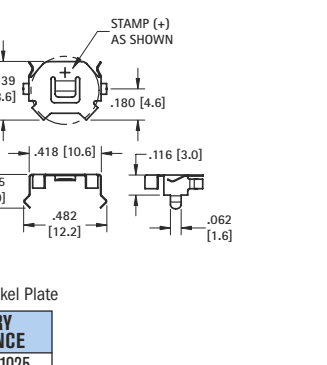

Mounting Detail

AVAILABLE ON TAPE AND REEL

11.6 mm



Surface Mount

MATERIAL: .010 (.25) Phosphor Bronze

CAT. NO. BULK	ON TAPE & REEL	FINISH	BATTERY REFERENCE
2996	2996TR	Tin-Nickel	SR44, LR44, 357, MS76,
3096	3096TR	Matte Tin	PX76A, G-13, 303, V313

Tape & Reel Spec's: 32mm wide; 16mm pitch; 13 inch reel (600 pieces per reel)

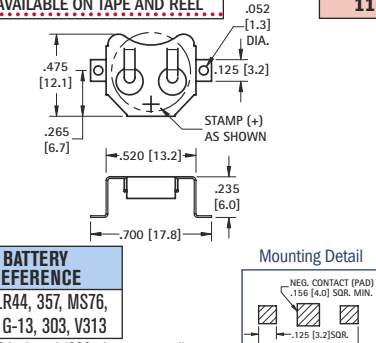

Mounting Detail

AVAILABLE ON TAPE AND REEL

11.6 mm



Thru Hole Mount

MATERIAL: .010 (.25) Phosphor Bronze, Tin-Nickel Plate

CAT. NO.	BATTERY REFERENCE
2997	SR44, LR44, 357, MS76, PX76A, G-13, 303, V313

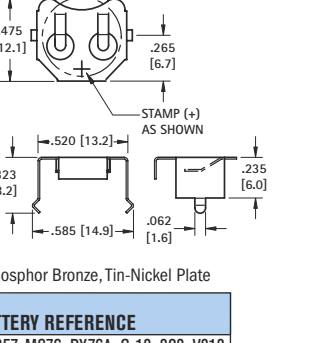

Mounting Detail

THRU HOLE (THM) & SURFACE MOUNT (SMT) COIN CELL RETAINERS

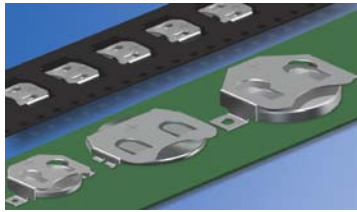

SURFACE MOUNT (SMT)

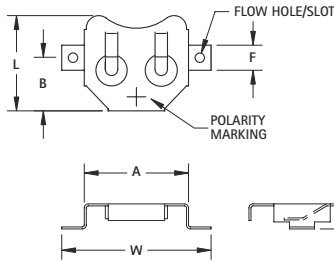

Battery retainers are suited for high density PCB packaging. Engineered with reliable spring tension, these contacts assure low resistance while firmly securing the battery within the retainer.

- Compatible with all wave and reflow operations
- Solder tails located outside of retainer body which facilitates visual inspection of the solder joints
- Flow-hole solder tail designed for increased joint strength
- Compatible with most vacuum and mechanical pick & place assembly systems
- Matte Tin Plate for lower soldering temperatures ideal where other temperature sensitive components are being used
- Tin-Nickel plated retainers are ideal for lead free, high temperature soldering applications
- All conductive polystyrene carrier tape meets ANSI/EIA-481 standards

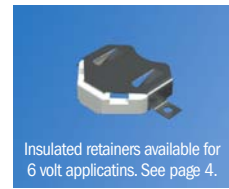

Insulated retainers available for 6 volt applications. See page 4.

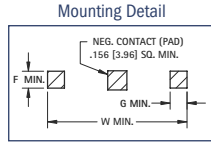

SURFACE MOUNT (SMT)

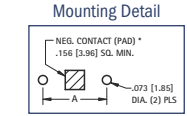
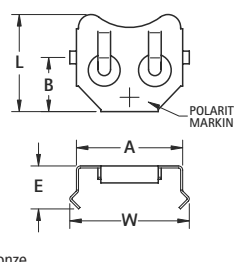

THRU HOLE MOUNT (THM)

MATERIAL: .010 (.25) Phosphor Bronze

TIN-NICKEL PLATE				MATTE TIN PLATE				REFER TO SURFACE MOUNT (SMT) DRAWING									
CAT. NO. BULK	ON TAPE & REEL	CAT. NO. BULK	ON TAPE & REEL	A	B	F	G	H	L	W	CELL DIA.	BATTERY REFERENCE	TAPE & REEL SPEC'S				
3000	3000TR	3080	3080TR	.520 (13.2)	.265 (6.7)	.125 (3.2)	.125 (3.2)	.125 (3.2)	.475 (12.1)	.745 (18.9)	12mm	CR1216, BR1220, CL1225	32mm wide; 16mm pitch; 1000/reel				
3012	3012TR	3092	3092TR	.664 (16.9)	.344 (8.7)	.125 (3.2)	.125 (3.2)	.156 (4.0)	.594 (15.1)	.914 (23.2)	16mm	BR1612, CR1616, CR1620, DL1632	44mm wide; 24mm pitch; 600/reel				
3028	3028TR	3038	3038TR	.831 (21.1)	.298 (7.6)	.200 (5.1)	.050 (1.3)	.067 (1.7)	.618 (15.7)	.911 (23.1)	20mm	BR2012, CR2012, DL2012	44mm wide; 24mm pitch; 1000/reel				
3026	3026TR	3078	3078TR	.831 (21.1)	.416 (10.6)	.200 (5.1)	.200 (5.1)	.085 (2.2)	.782 (19.9)	1.210 (30.7)	20mm	BR2016, CR2016, DL2016	44mm wide; 32mm pitch; 750/reel				
3034	3034TR	3044	3044TR	.835 (21.2)	.291 (7.4)	.200 (5.1)	.050 (1.3)	.160 (4.1)	.635 (16.1)	0.915 (23.1)	20mm	DL2020, CR2025, CR2032	44mm wide; 24mm pitch; 500/reel				
3002	3002TR	3082	3082TR	.831 (21.1)	.416 (10.6)	.200 (5.1)	.200 (5.1)	.156 (4.0)	.782 (19.9)	1.210 (30.7)	20mm	DL2020, CR2025, CR2032	44mm wide; 24mm pitch; 500/reel				
3004	3004TR	3084	3084TR	.939 (23.9)	.475 (12.1)	.200 (5.1)	.200 (5.1)	.156 (4.0)	.832 (21.1)	1.339 (34.0)	23mm	BR2320, CL2325, CR2330, DL2335	56mm wide; 32mm pitch; 400/reel				
3010	3010TR	3090	3090TR	.939 (23.9)	.475 (12.1)	.200 (5.1)	.200 (5.1)	.240 (6.1)	.819 (20.8)	1.339 (34.0)	23mm	CR2354, DL2354	56mm wide; 32mm pitch; 200/reel				
3032	3032TR	3042	3042TR	1.000 (25.4)	.313 (8.0)	.200 (5.1)	.050 (1.3)	.067 (1.7)	.681 (17.3)	1.080 (27.4)	24mm	BR2412, CR2412	44mm wide, 24mm pitch, 1000/reel				
3006	3006TR	3086	3086TR	1.000 (25.4)	.506 (12.9)	.200 (5.1)	.200 (5.1)	.156 (4.0)	.918 (23.3)	1.400 (35.6)	24mm	CR2430, DL2430	56mm wide; 32mm pitch; 400/reel				
3008	3008TR	3088	3088TR	1.000 (25.4)	.506 (12.9)	.200 (5.1)	.200 (5.1)	.230 (5.8)	.890 (22.6)	1.400 (35.6)	24mm	CR2450, DL2450	56mm wide; 32mm pitch; 200/reel				

TIN-NICKEL PLATE		REFER TO THRU HOLE MOUNT (THM) DRAWING									
CAT. NO. BULK		A	B	E	H	L	W	CELL DIA.	BATTERY REFERENCE		
3001		.520 (13.2)	.265 (6.7)	.210 (5.3)	.118 (3.0)	.475 (12.1)	.585 (14.9)	12mm	BR1216, CR1216, BR1220, CL1220, CR1220, BR1225		
3013		.664 (16.9)	.344 (8.7)	.265 (6.7)	.156 (4.0)	.594 (15.1)	.723 (18.4)	16mm	BR1616, CR1612, CR1616, CR1620, CR1632		
3029		.831 (21.1)	.298 (7.6)	.176 (4.5)	.067 (1.7)	.618 (15.7)	.890 (22.6)	20mm	BR2012, CR2012, DL2012		
3027		.831 (21.1)	.416 (10.6)	.194 (4.9)	.085 (2.2)	.782 (19.9)	.890 (22.6)		BR2016, CR2016, DL2016		
3003		.831 (21.1)	.416 (10.6)	.265 (6.7)	.156 (4.0)	.782 (19.9)	.890 (22.6)	23mm	BR2016, DL2020, CR2320, CR2025, CR2032		
3005		.939 (23.9)	.475 (12.1)	.265 (6.7)	.156 (4.0)	.832 (21.1)	1.004 (25.5)		BR2320, CL2330, CR2320, BR2325, CR2325, DL2325		
3011		.939 (23.9)	.475 (12.1)	.351 (8.9)	.240 (6.1)	.819 (20.8)	1.004 (25.5)	24mm	CR2354, DL2354		
3033		1.000 (25.4)	.313 (8.0)	.176 (4.5)	.067 (1.7)	.681 (17.3)	1.055 (26.8)		BR2412, CR2412		
3007		1.000 (25.4)	.506 (12.9)	.265 (6.7)	.156 (4.0)	.918 (23.3)	1.055 (26.8)	24mm	CR2430, DL2430		
3009		1.000 (25.4)	.506 (12.9)	.350 (8.9)	.230 (5.8)	.890 (22.5)	1.059 (26.9)		CR2450, DL2450		
3039		1.000 (25.4)	.506 (12.9)	.450 (11.4)	.336 (8.5)	.890 (22.5)	1.059 (26.9)		CR2477, DL2477		

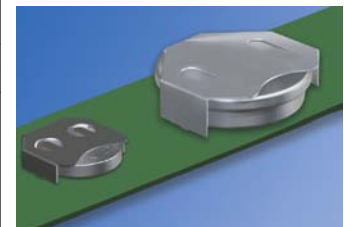

THRU HOLE MOUNT (THM)

NEGATIVE BATTERY CONTACTS*

AVAILABLE ON TAPE AND REEL



- Assures proper contact

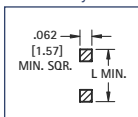

COMPACT

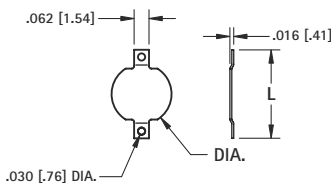

DWG. 1 MATERIAL: .008 (.20) Brass



- Assures proper contact

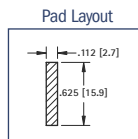

SPRING CONTACT

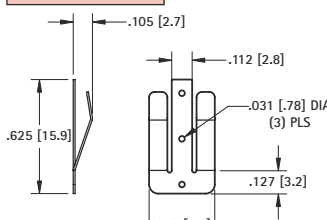

DWG. 2 MATERIAL: .010 (.25) Phosphor Bronze



Thru Hole Mount

- Snap-In
- Assures proper contact

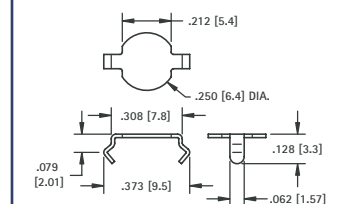

MATERIAL: .008 (.20) Phosphor Bronze, Tin-Nickel Plate
CAT. NO. 2990

Mounting Detail

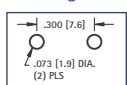

TIN-NICKEL PLATE		MATTE TIN PLATE		DWG.	L	DIA.	TAPE & REEL SPECS
CAT. NO. BULK	ON TAPE & REEL	CAT. NO. BULK	ON TAPE & REEL				
2991	2991TR	2981	2981TR	1	.368 (9.4)	.250 (6.4)	16mm wide, 8mm pitch, 1500/7 reel
2992	2992TR	2982	2982TR	1	.289 (7.4)	.186 (4.7)	16mm wide, 12mm pitch, 1000/7 reel
2993	2993TR	2983	2983TR	2	.625 (15.9)	-	24mm wide, 16mm pitch, 1000/13 reel

*Note: Cannot be used with Cat. No. 3028, 3029, 3032, 3033.

12mm to 24mm COIN CELL RETAINERS

SURFACE MOUNT BATTERY CLIPS/CONTACTS

AVAILABLE ON TAPE AND REEL

- "Flow-Hole" SMT solder tail design for increased joint strength
- Tin-Nickel plating is ideal for lead free, high temperature soldering
- Matte Tin Plate for lower soldering temperatures ideal where other temperature sensitive components are being used

Refer to page 32 for Battery Contact Layout & Mounting Details

SURFACE MOUNT BATTERY CLIPS & CONTACTS

"AAAA" - "A27"

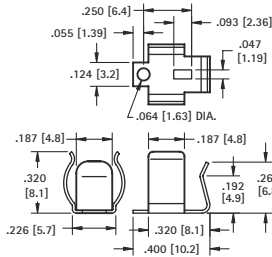

MATERIAL: .010 (.25) Spring Steel

TIN-NICKEL PLATE		MATTE TIN PLATE	
CAT. NO.	ON TAPE	CAT. NO.	ON TAPE
BULK	& REEL	BULK	& REEL
50	50TR	550	550TR

Tape & Reel Spec's: 24mm wide; 16mm pitch; 13 inch reel, (500 pieces per reel)

Pad Layout

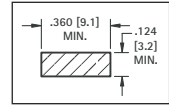

"AAA" - "N" - "A23"

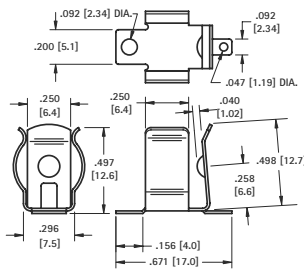

MATERIAL: .010 (.25) Spring Steel

TIN-NICKEL PLATE		MATTE TIN PLATE	
CAT. NO.	ON TAPE	CAT. NO.	ON TAPE
BULK	& REEL	BULK	& REEL
55	55TR	555	555TR

Tape & Reel Spec's: 32mm wide; 16mm pitch; 13 inch reel, (300 pieces per reel)

Pad Layout

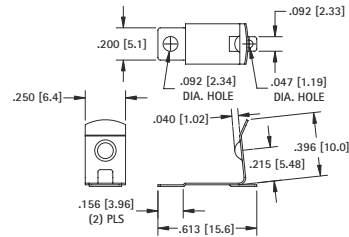
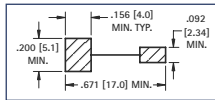

MATERIAL: .010 (.25) Spring Steel

TIN-NICKEL PLATE		MATTE TIN PLATE	
CAT. NO.	ON TAPE	CAT. NO.	ON TAPE
BULK	& REEL	BULK	& REEL
56	56TR	556	556TR

Tape & Reel Spec's: 32mm wide; 20mm pitch; 13 inch reel, (250 pieces per reel)

Pad Layout

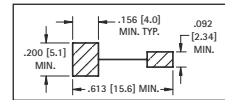

"AA" - "CR2" - "A"

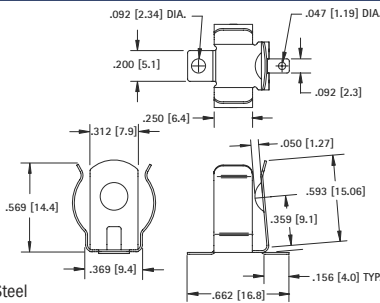
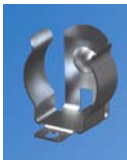

MATERIAL: .012 (.30) Spring Steel

TIN-NICKEL PLATE		MATTE TIN PLATE	
CAT. NO.	ON TAPE	CAT. NO.	ON TAPE
BULK	& REEL	BULK	& REEL
53	53TR	553	553TR

Tape & Reel Spec's: 32mm wide; 24mm pitch; 13 inch reel, (150 pieces per reel)

Pad Layout

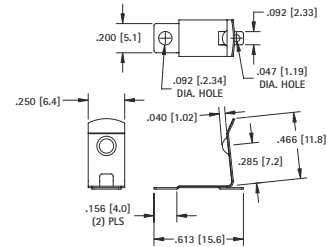
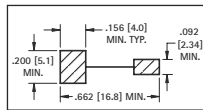

MATERIAL: .010 (.25) Spring Steel

TIN-NICKEL PLATE		MATTE TIN PLATE	
CAT. NO.	ON TAPE	CAT. NO.	ON TAPE
BULK	& REEL	BULK	& REEL
57	57TR	557	557TR

Tape & Reel Spec's: 32mm wide; 20mm pitch; 13 inch reel, (250 pieces per reel)

Pad Layout

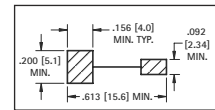

SURFACE MOUNT LEAF-SPRING CONTACTS

AVAILABLE ON TAPE AND REEL

- Economical & reliable contacts are ideal for surface mount applications
- Unique spring tension contacts adjust to variations in battery length
- Reliable spring tension contacts assure low contact resistance
- SMT solder tail with "flow-hole" design for increased joint strength

"AAA" - "AAAA" - "12V" - "N"

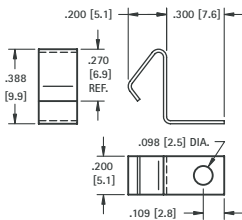

MATERIAL: .010 (.25) Spring Steel

TIN-NICKEL PLATE		MATTE TIN PLATE	
CAT. NO.	ON TAPE	CAT. NO.	ON TAPE
BULK	& REEL	BULK	& REEL
5230	5230TR	5330	5330TR

Tape and Reel Spec's: 24mm wide; 12mm pitch; 13 inch reel (400 pieces per reel)

"AA" - "CR2" - "A" - "9V"

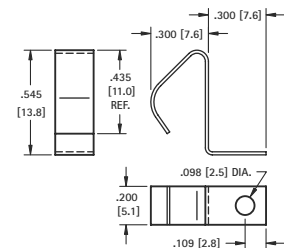

MATERIAL: .010 (.25) Spring Steel

TIN-NICKEL PLATE		MATTE TIN PLATE	
CAT. NO.	ON TAPE	CAT. NO.	ON TAPE
BULK	& REEL	BULK	& REEL
5231	5231TR	5331	5331TR

Tape and Reel Spec's: 32mm wide; 16mm pitch; 13 inch reel (250 pieces per reel)

PC BATTERY CLIPS



- Mounts securely to the PC board with advanced "Snap-In" design for thru hole mounting
- Reliable spring tension assures low contact resistance
- Low profile, economical design
- Retains battery securely to withstand shock and vibration
- AAAA, AAA, AA, N, 12V, 2/3A, 17-19mm



Refer to page 33 for Battery Contact Layout & Mounting Details

"AAAA" - "A27"

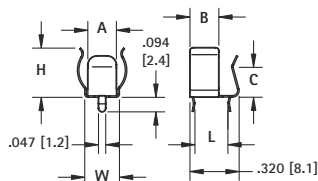

FIG. 1

"AAA" - "N" - "A23" - "AA" - "CR2"

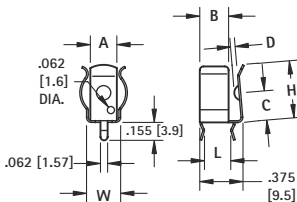
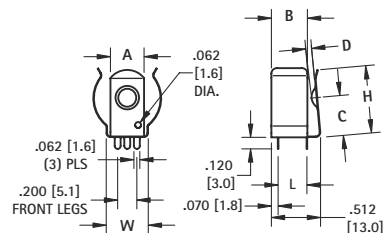

FIG. 2

"A" - 17-19mm*



*17335, 17450, 17500, 17650, 18600, 18650 cells

FIG. 3

MATERIAL: Spring Steel, Tin-Nickel Plate

CAT. NO.	FIG.	BATTERY SIZE	BATTERY DIAMETER	A	B	C	D	H	L	W	MATERIAL THICKNESS
51	1	"AAAA" - "A27"	.300-.350 (7.6-8.9)	.187 (4.8)	.187 (4.8)	.194 (4.9)	-	.320 (8.1)	.214 (5.4)	.226 (5.7)	.010 (.25)
82	2	"AAA" - "N" - "A23"	.375-.460 (9.5-11.7)	.250 (6.4)	.250 (6.4)	.280 (7.1)	.040 (1.0)	.498 (12.7)	.228 (5.8)	.296 (7.5)	.010 (.25)
52	2	"AA" - "CR2"	No Ears	.250 (6.4)	-	.280 (7.1)	.032 (0.8)	.498 (12.7)	.228 (5.8)	.250 (6.4)	.010 (.25)
92	2	"AA" - "CR2"	.531-.665 (13.5-16.9)	.312 (7.9)	.250 (6.4)	.359 (9.1)	.050 (1.3)	.593 (15.1)	.228 (5.8)	.369 (9.4)	.012 (.30)
2915	2	"AA" - "CR2"	.531-.665 (13.5-16.9)	.312 (7.9)	.250 (6.4)	.359 (9.1)	.050 (1.3)	.593 (15.1)	.228 (5.8)	.376 (9.5)	.015 (.38)
54	3	"A" - 17-19mm"	.669-.748 (17.0-19.0)	.350 (8.9)	.375 (9.5)	.385 (9.8)	.062 (1.6)	.653 (16.6)	.300 (7.6)	.438 (11.1)	.012 (.30)

*Battery Reference: 2/3A, 17335, 17450, 17500, 17650, 18500, 18650 cells

P.C. BUTTON & SPRING CONTACTS



- Space saving design installs directly onto the PC board
- Suitable for .062 (1.57) to .093 (2.36) PC boards
- Reliable spring tension assures low contact resistance
- Ideal for self-contained battery compartments



COIL SPRING

"CR2" - "AA"

(+) POSITIVE BUTTON

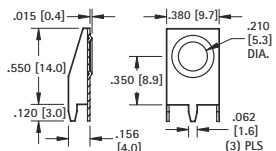

MATERIAL:
Frame: .015 (.38)
Steel, Tin-Nickel Plate

CAT. NO. 595

(-) NEGATIVE SPRING

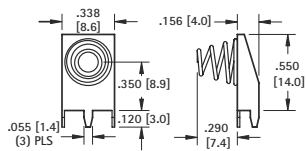

MATERIAL:
Frame: .015 (.38) Steel,
Matte Tin Plate

CAT. NO. 628

"AAA" - "AA" - "N" - "A23"

(+) POSITIVE BUTTON

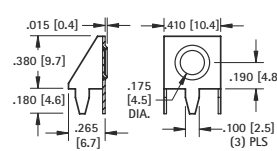

MATERIAL:
Frame: .015 (.38) Steel,
Tin-Nickel Plate

CAT. NO. 637

(-) NEGATIVE SPRING

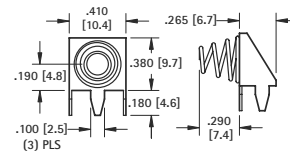

MATERIAL:
Frame: .015 (.38)
Steel, Matte Tin Plate

CAT. NO. 629

LEAF SPRING

MATERIAL: .012 (.30) Spring Steel, Tin-Nickel Plate

"AA" - "CR2" - "A"

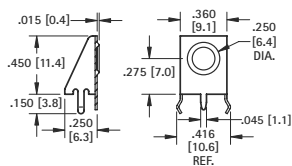

CAT. NO. 596

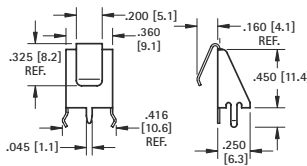

CAT. NO. 590

MATERIAL: .010 (.25) Spring Steel, Tin-Nickel Plate

"AAA" - "N" - "A23"

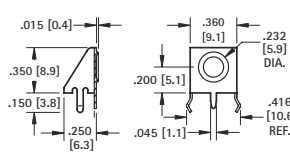

CAT. NO. 597

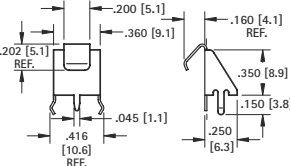

CAT. NO. 591

RUGGED STEEL BATTERY CLIPS

“AA” - “C” - “D”

Refer to page 32 for Battery Contact Layout & Mounting Details

SPECIFICATIONS Clips: Spring Steel, Nickel Plate **Contact Eyelets:** Brass, Nickel Plate
Insulating Washers: Moisture Proof, Resin Impregnated Fibre **Solder Lugs:** Brass, Tin Plate
 • Available with insulated or non-insulated contact. Positive contact grips battery securely.

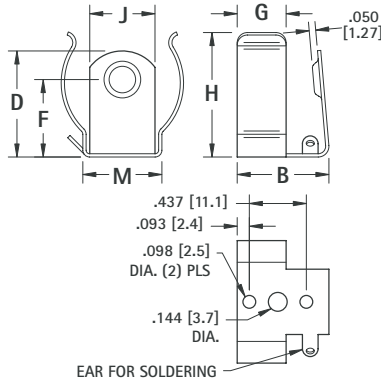
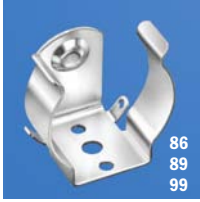

DWG. 1
Non-Insulated Contact

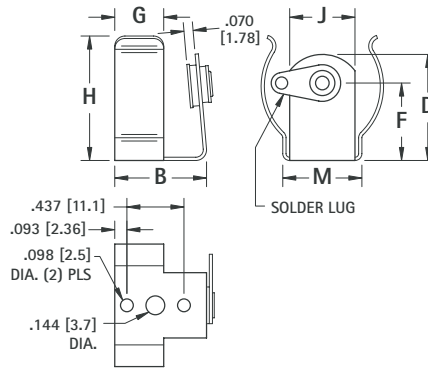

DWG. 2
Insulated Contact

CAT. NO.	DWG. NO.	B	D	F	G	H	J	M	STEEL THICKNESS	BATTERY DIAMETER MIN. - MAX.	CELL SIZE
86	1	.703 (17.9)	.812 (20.6)	.593 (15.1)	.375 (9.5)	.937 (23.8)	.500 (12.7)	.605 (15.4)	.020 (.51)	.875 to 1.125 (22.2 to 28.6)	“C”
87	2										
88	2	.775 (19.7)	1.075 (27.3)	.750 (19.1)	.437 (11.1)	1.187 (30.1)	.500 (12.7)	.609 (15.5)	.020 (.51)	1.187 to 1.350 (30.1 to 34.3)	“D”
89	1										
99	1	.703 (17.9)	.609 (15.5)	.375 (9.5)	.375 (9.5)	.609 (15.5)	.312 (7.9)	.353 (9.0)	.015 (.39)	.531 to .650 (13.5 to 16.5)	“AA”
100	2										

ECONOMY CONTACTS

“AA” - “C” - “D”

Refer to page 32 for Battery Contact Layout & Mounting Details

- Designed for mounting in self-contained, non-metallic battery compartments.
- Reliable spring tension assures low contact resistance.
- Recessed contact holds battery in place.
- All clips have anti-rotation tab.

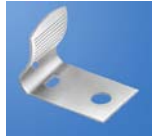
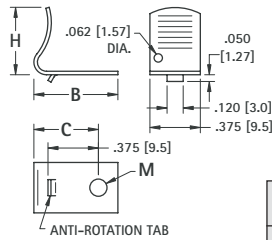

FIG. 1



MATERIAL: .016 (.41) Spring Steel, Nickel Plate

CAT. NO.	FIG. NO.	B	C	H	M MTB. HOLE	CELL SIZE
206	1	.625 (15.9)	.480 (12.2)	.500 (12.7)	.128 (3.3)	“AA”
207	2	.687 (17.4)	.547 (13.9)	.875 (22.2)	.128 (3.3)	“C”
208	2	.750 (19.1)	.562 (14.3)	1.260 (32.0)	.128 (3.3)	“D”

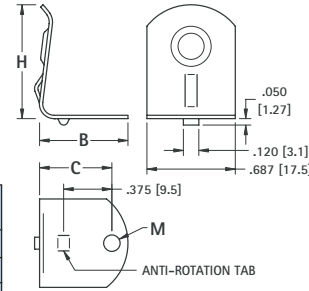
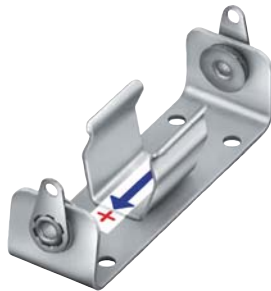
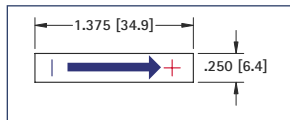

FIG. 2

POLARITY INDICATING LABEL

- No Gluing or Wetting Needed
- Economical
- Pressure Sensitive Adhesive Back
- Adheres To All Surfaces

Recommended where proper polarity of battery insertion or circuit polarity is to be shown. Labels are two color, (+) positive side red; arrow, (-) negative side blue.



CAT. NO. 58

BATTERY SPRING CONTACTS

“2/3A” - “AA” - “C” - “D”

Easy to assemble with eyelets or rivets. Refer to page 142.

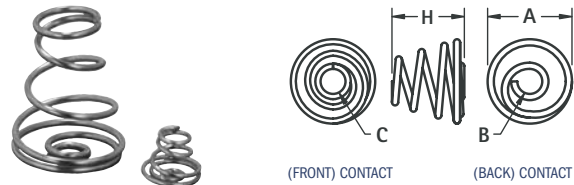

CAT. NO.	H	A	B	C	MATERIAL	CELL SIZE
211	.290 (7.4)	.335 (8.5)	.100 (2.5)	.140 (3.6)	.025 (.64) Dia. Spring Steel, Nickel Plate	“2/3 A” - “AA”
211-D	.850 (21.6)	.650 (16.5)	.162 (4.1)	.300 (7.6)	.040 (1.0) Dia. Spring Steel, Nickel Plate	“C” - “D”

INSULATED POLARIZING WASHERS

Prevents improper connection of battery which may cause damage to electronic equipment. Washers hold securely when snapped over eyelets. Used on our standardized battery holders. For “AA”, “C” & “D” cells.



CAT. NO. 59 (RED)

CAT. NO. 60 (BLACK)

MATERIAL: Molded Polyethylene

ALUMINUM & STEEL CLIPS

Precision made spring clips are available in a wide range of sizes. These clips will hold round, square and rectangular batteries or components with similar dimensions. Clips are manufactured from Aluminum or Spring Steel.

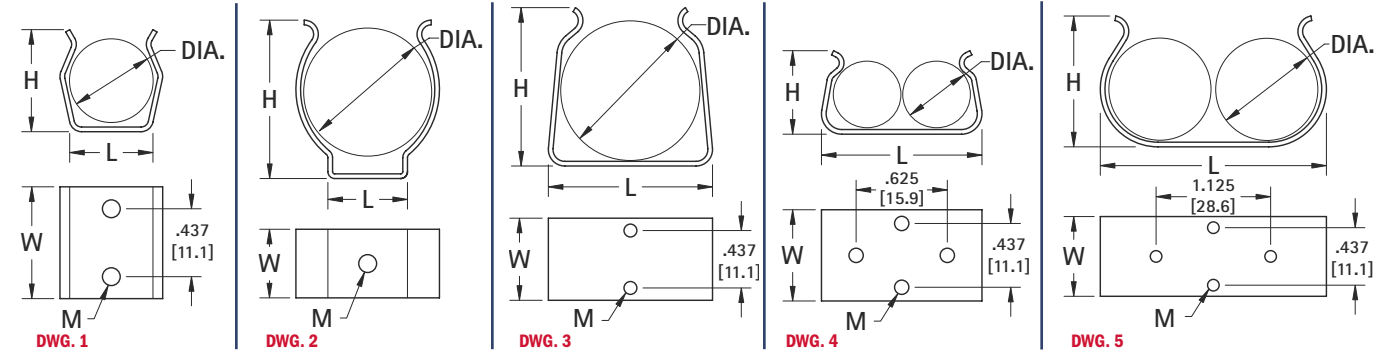
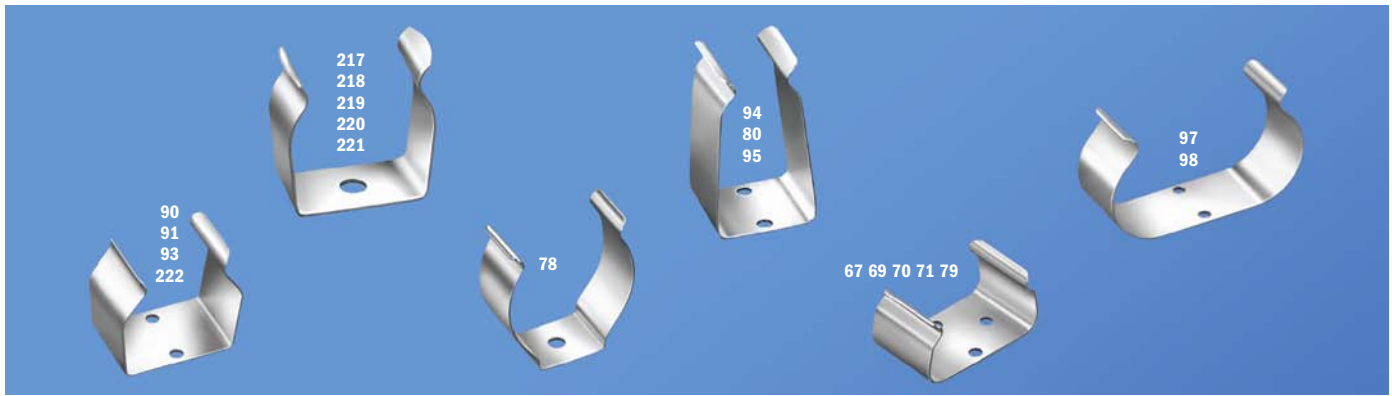

MATERIAL: Steel Clips: Spring Steel, Nickel Plate Aluminum Clips: 2024-T3

CAT. NO.	DWG. NO.	REF: CELL SIZE/BATTERY DIA. (SQ.)	H	L	W	M	MATERIAL
"AAA" CELL							
90	1	.375 to .468 (9.5 to 11.9)	.453 (11.5)	.312 (7.9)	.625 (15.9)	.098 (2.5)	.020 (.51) Alum.
"AA", "CR2" CELL							
91	1	.531 to .656 (13.5 to 16.7)	.562 (14.3)	.406 (10.3)	.625 (15.9)	.098 (2.5)	.020 (.51) Alum.
69	4		.562 (14.3)	1.125 (28.6)	.625 (15.9)	.098 (2.5)	.015 (.39) Steel
"C" CELL							
222	1	.875 to 1.125 (22.2 to 28.6)	.921 (23.4)	.937 (23.8)	.625 (15.9)	.098 (2.5)	.020 (.51) Steel
93	1		.921 (23.4)	.937 (23.8)	.625 (15.9)	.098 (2.5)	.020 (.51) Alum.
97*	5		1.125 (28.6)	2.062 (52.4)	.625 (15.9)	.098 (2.5)	.020 (.51) Alum.
"D" CELL							
94	3	1.187 to 1.375 (30.1 to 34.9)	1.218 (30.9)	1.250 (31.8)	.625 (15.9)	.098 (2.5)	.032 (.81) Alum.
78	2		1.218 (30.9)	.562 (14.3)	.500 (12.7)	.136 (3.5)	.020 (.51) Steel
98	5		1.437 (36.5)	2.656 (67.5)	1.000 (25.4)	.098 (2.5)	.032 (.81) Alum.
"A", "2/3A" CELL							
70	4	.656 to .690 (16.7 to 17.0)	.740 (18.8)	1.343 (34.1)	.625 (15.9)	.098 (2.5)	.025 (.64) Alum.
"9" VOLT CELL							
71	3	.593 (15.1) × 1.031 (26.2)	.687 (17.4)	1.031 (26.2)	.625 (15.9)	.098 (2.5)	.015 (.39) Steel
79	4	.650 (16.5) × 1.043 (26.5)	.765 (19.4)	1.050 (26.7)	.625 (15.9)	.098 (2.5)	.015 (.39) Steel
66	3	.689 (17.5) × 1.043 (26.5)	.825 (21.0)	1.069 (27.2)	.625 (15.9)	.098 (2.5)	.015 (.39) Steel
80	3	.650 (16.5) × 1.043 (26.5)	1.187 (30.1)	.675 (17.1)	.625 (15.9)	.098 (2.5)	.015 (.39) Steel
95	3	.650 (16.5) × 1.043 (26.5)	1.125 (28.6)	.656 (16.7)	.625 (15.9)	.098 (2.5)	.020 (.51) Alum.
"NiCd" CELL							
217	2	1.375 to 1.500 (34.9 to 38.1)	1.430 (36.3)	1.218 (30.9)	.812 (20.6)	.157 (4.0)	.025 (.64) Steel
218	2	1.437 to 1.687 (36.5 to 42.8)	1.531 (38.9)	1.375 (34.9)	.812 (20.6)	.157 (4.0)	.025 (.64) Steel
219	2	2.000 to 2.500 (50.8 to 63.5)	2.156 (54.8)	1.687 (42.8)	.812 (20.6)	.157 (4.0)	.025 (.64) Steel
"SUB-C" CELL							
221	2	.859 to .890 (21.8 to 22.6)	.906 (23.0)	.828 (21)	.468 (11.9)	.157 (4.0)	.020 (.51) Steel

*ONLY TWO MOUNTING HOLES

BATTERY RETAINER CLIPS

- Prevents battery from loosening in battery holder
- Retainer clip slips on the ears of the battery holder clip



"AA" - "CR2"

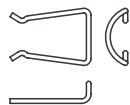

Used with Keystone Battery Clips
Cat. No. 91, 92, 95, 99, 100 and 2915.

MATERIAL: Stainless Steel

CAT. NO. 61

"C"

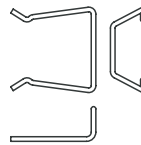

Used with Keystone Battery Clips
Cat. No. 86, 87, 93 and 222.

MATERIAL: Spring Steel, Nickel Plate

CAT. NO. 62

"D"

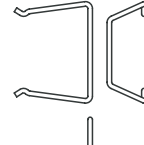

Used with Keystone Battery Clips Cat. No. 88, 89 and 94.

MATERIAL: Spring Steel, Nickel Plate

CAT. NO. 63

SNAP-ON CONTACTS



- Economical and reliable contacts are ideal for molded cases with self contained battery compartments
- Solder "ear" to facilitate soldering of wire lead
- Unique spring tension contact adjusts to variations in battery length
- Reliable spring tension contacts assure low contact resistance
- Clips easily onto .060 (1.52) to .070 (1.78) wall
- Sharp barbs securely anchor contact in place

Refer to page 34 for Battery Contact Layout & Mounting Details

"AAA" • "AAAA" • "N" • "12V"



CAT. NO. 204

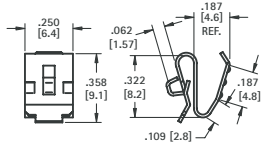

MATERIAL: .010 (.25) Spring Steel, Nickel Plate



CAT. NO. 238

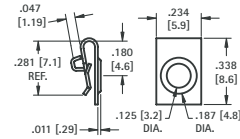

MATERIAL: .010 (.25) Spring Steel, Nickel Plate



CAT. NO. 202

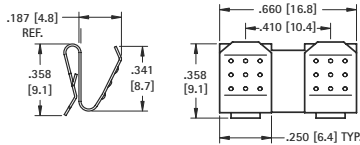

MATERIAL: .010 (.25) Spring Steel, Nickel Plate



CAT. NO. 294

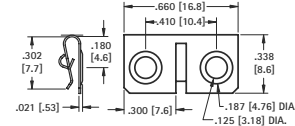

MATERIAL: .010 (.25) Spring Steel, Nickel Plate



CAT. NO. 295

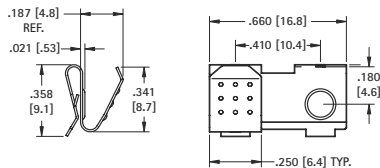

MATERIAL: .010 (.25) Spring Steel, Nickel Plate



CAT. NO. 296

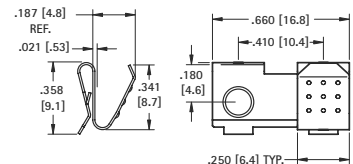

MATERIAL: .010 (.25) Spring Steel, Nickel Plate

"AA" • "CR2" • "A"



CAT. NO. 209

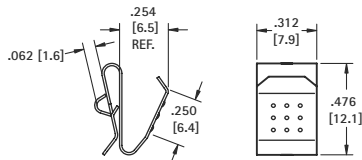

MATERIAL: 012 (.30) Spring Steel, Nickel Plate



CAT. NO. 228

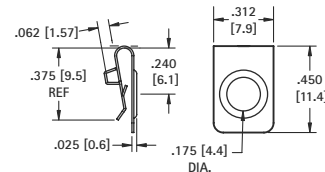

MATERIAL: 010 (.25) Spring Steel, Nickel Plate

"AA"



CAT. NO. 288

- The (2) two leaf contacts are separate, allowing a divider between the batteries.

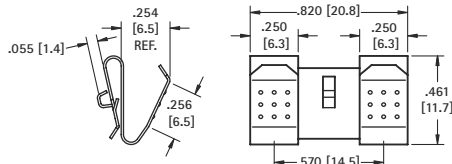

MATERIAL: 012 (.30) Spring Steel, Nickel Plate

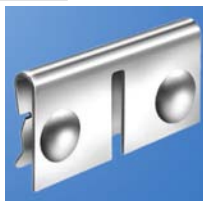

CAT. NO. 292

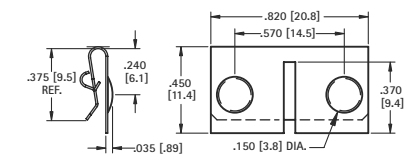

MATERIAL: 010 (.25) Spring Steel, Nickel Plate



CAT. NO. 210

- The (2) two leaf contacts are held together by a web. This design offers greater stability.

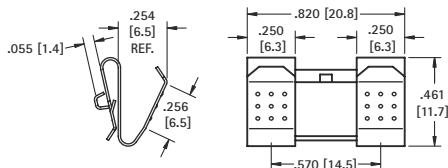

MATERIAL: .012 (.30) Spring Steel, Nickel Plate



CAT. NO. 291 Right

CAT. NO. 290 Left (shown)

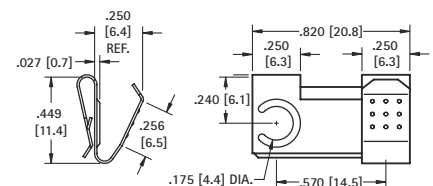

MATERIAL: 012 (.30) Spring Steel, Nickel Plate

SLIDE-IN MOUNT CONTACTS



- Economical and reliable contacts are ideal for molded cases with self contained battery compartments
- Solder "ear" to facilitate soldering of wire lead
- Unique spring tension contact adjusts to variations in battery lengths
- Reliable spring tension contacts assure low contact resistance
- Clips easily onto .060 (1.52) to .070 (1.78) wall
- Sharp barbs securely anchor contact

Refer to page 34 for Battery Contact Layout & Mounting Details

"AA" • "CR2" • "A" • "9V"

- Press fit into housing groove.

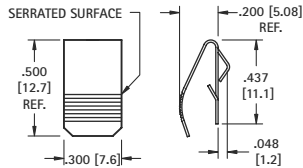
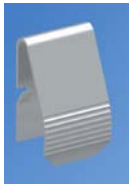

CAT. NO. 5205

MATERIAL: .012 (.30) Spring Steel, Nickel Plate

"AA"

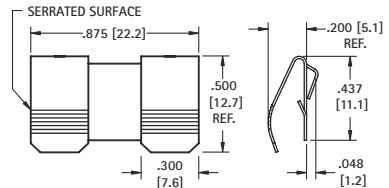

CAT. NO. 5206

MATERIAL: .012 (.30) Spring Steel, Nickel Plate

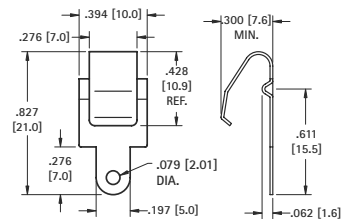

CAT. NO. 5209

MATERIAL: .012 (.30) Phosphor Bronze, Nickel Plate

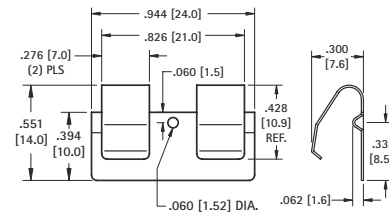

CAT. NO. 5208

MATERIAL: .012 (.30) Phosphor Bronze, Nickel Plate

SLIDE-IN P.C. MOUNT CONTACTS

- Economical and reliable contacts
- Designed for direct placement onto PCB, no wire leads required
- Unique spring tension adjusts to variations in battery length

- Reliable spring tension assure low contact resistance and dependable connection
- Symmetrical design allows these contacts to function both as a positive and negative contacts

"AAA" • "AAAA" • "N" • "12V"

UNIVERSAL BATTERY SIZES

MATERIAL: .012 (.30) Phosphor Bronze, Tin-Nickel plate

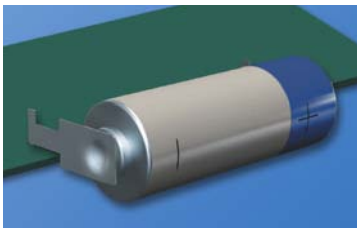

- "Off-Board" edge mounting design frees up valuable board space

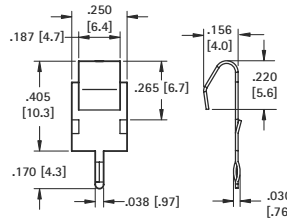

CAT. NO. 1021-1

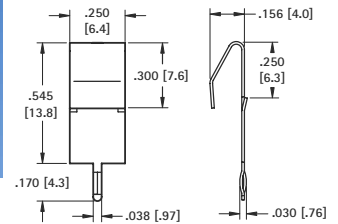

CAT. NO. 1017-1

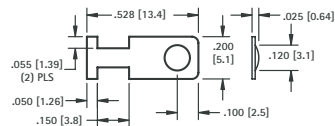

CAT. NO. 230-1

MATERIAL: .008 (.20) Spring Steel, Nickel plate

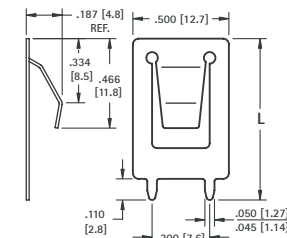

CAT. NO.	(L) Length
109-2	.840 (21.3)
109-3	1.000 (25.4)

MATERIAL: .012 (.30) Spring Steel, Nickel plate

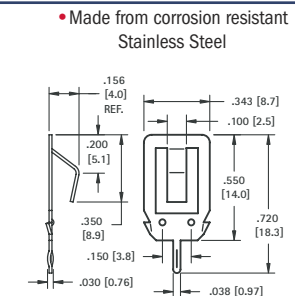

CAT. NO. 108-2

MATERIAL: .012 (.30) Stainless Steel, Tin-Nickel plate

SPRING & BUTTON CONTACTS

- Economical and reliable contacts are ideal for molded cases with self contained battery compartments
- "Solder tab" design for either wire lead or PC mounting
- Unique spring contacts adjust to variations in battery lengths
- Reliable spring contacts assure low contact resistance and a dependable connection
- Space saving, economical, excellent mechanical construction



Refer to page 35 for Battery Contact Layout & Mounting Details

MATERIAL:

Plate: .020 (.51) Steel, Nickel Plate **Spring:** Spring Steel, Nickel Plate

BATTERY CONTACTS FOR MOLDED CASES

"AAA" - "AAAA" - "N" - "12V"



(-) NEGATIVE SPRING

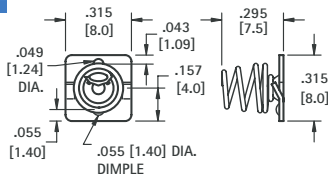

CAT. NO. 5203



(+) POSITIVE BUTTON

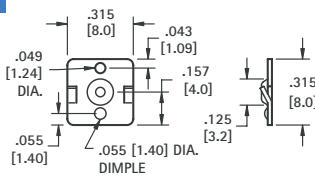

CAT. NO. 5225



DUAL CONTACT (RIGHT)

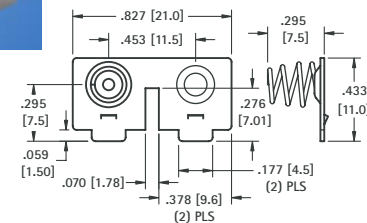

CAT. NO. 5213



(-) NEGATIVE SPRING WITH TAB

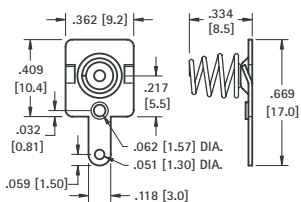

CAT. NO. 5204



(+) POSITIVE BUTTON WITH TAB

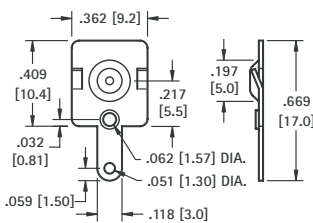

CAT. NO. 5226



DUAL CONTACT (LEFT)

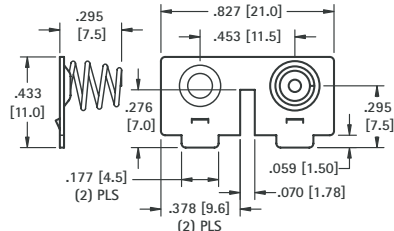

CAT. NO. 5214

"AA" - "CR2" - "A"



(+) POSITIVE BUTTON

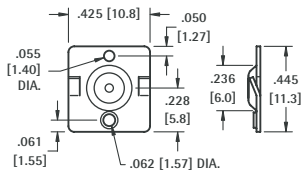

CAT. NO. 5224



(-) NEGATIVE SPRING

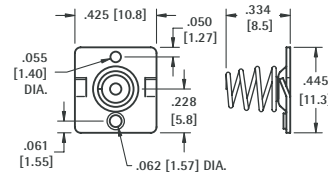

CAT. NO. 5202

"AA"



DUAL BUTTON CONTACT

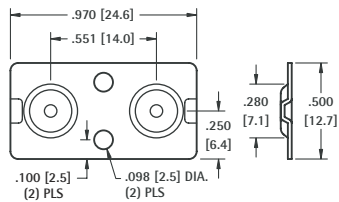

CAT. NO. 5227



DUAL SPRING CONTACT

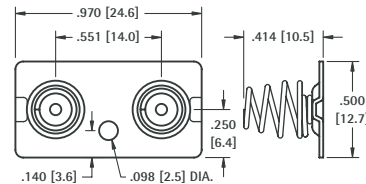

CAT. NO. 5228

SPRING & BUTTON CONTACTS

- Economical and reliable contacts are ideal for molded cases with self contained battery compartments
- "Solder tab" design for either wire lead or PC mounting
- Unique spring contacts adjust to variations in battery lengths
- Reliable spring contacts assure low contact resistance and a dependable connection
- Space saving, economical, excellent mechanical construction

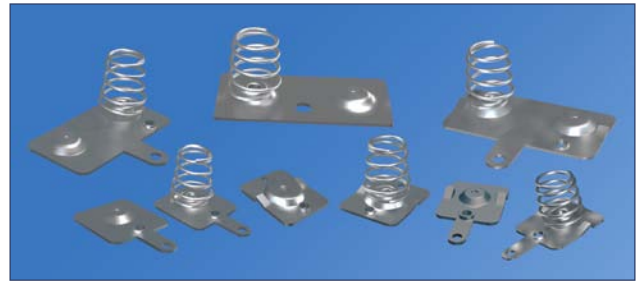

MATERIAL:

Plate: .020 (.51) Steel, Nickel Plate **Spring:** Spring Steel, Nickel Plate

Refer to page 35 for Battery Contact Layout & Mounting Details

"AA" • "CR2" • "A"

(-) NEGATIVE SPRING

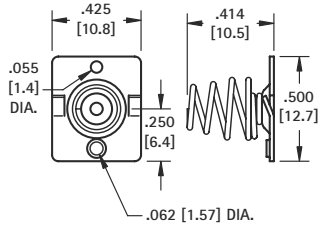

CAT. NO. 5222

(+) POSITIVE BUTTON

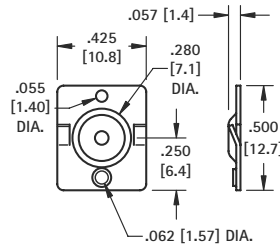

CAT. NO. 5221

DUAL CONTACT ("AA" ONLY)

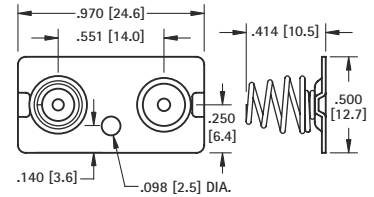

CAT. NO. 5212 Left or Right

(-) NEGATIVE SPRING WITH TAB

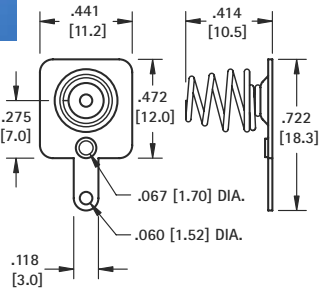

CAT. NO. 5201

(+) POSITIVE BUTTON WITH TAB

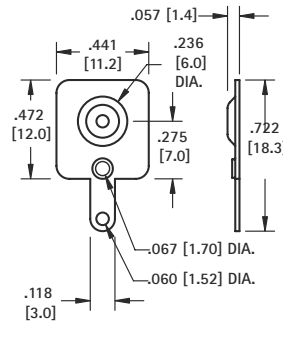

CAT. NO. 5223

DUAL CONTACT ("AA" ONLY)

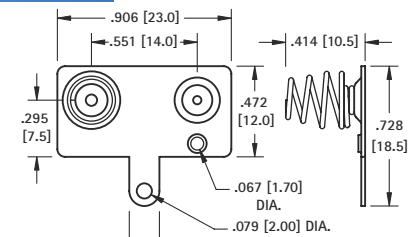
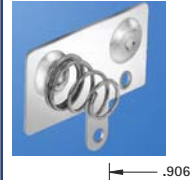

CAT. NO. 5210 Left

CAT. NO. 5211 Right (Shown)

(-) NEGATIVE SPRING WITH TAB/LANCE

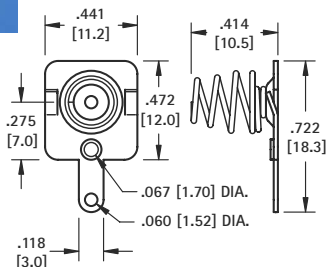

CAT. NO. 5220

(+) POSITIVE BUTTON WITH TAB/LANCE

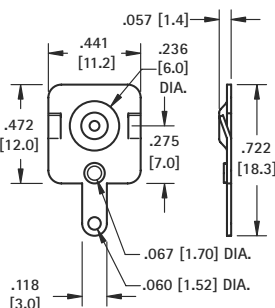

CAT. NO. 5219

DUAL CONTACT WITH TAB ("AA" ONLY)

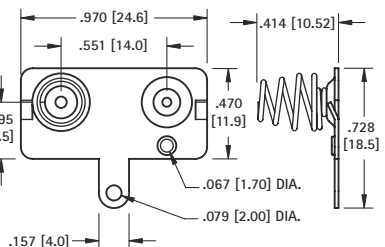

CAT. NO. 5218 Left

CAT. NO. 5217 Right (Shown)

SPRING & BUTTON CONTACTS

- Economical and reliable contacts are ideal for molded cases with self contained battery compartments
- "Solder tab" design for either wire lead or PC mounting
- Unique spring contacts adjust to variations in battery lengths
- Reliable spring contacts assure low contact resistance and a dependable connection
- Space saving, economical, excellent mechanical construction

MATERIAL:

Plate: .020 (.51) Steel, Nickel Plate **Spring:** Spring Steel, Nickel Plate



Refer to page 35 for Battery Contact Layout & Mounting Details

BATTERY CONTACTS FOR MOLDED CASES

"C" CELL

(+) POSITIVE BUTTON

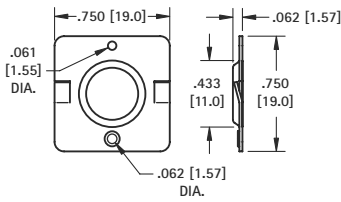

CAT. NO. 5240

(-) NEGATIVE SPRING

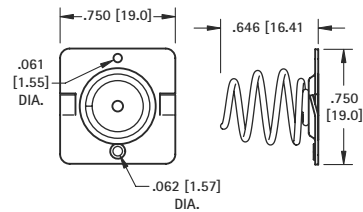

CAT. NO. 5241

DUAL CONTACT

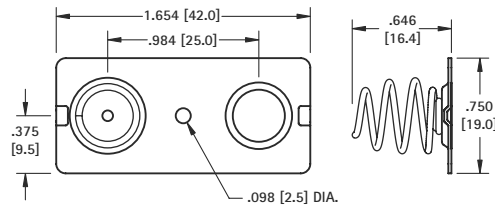
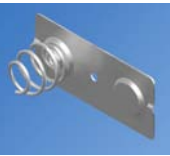

CAT. NO. 5242

"D" CELL

(+) POSITIVE BUTTON

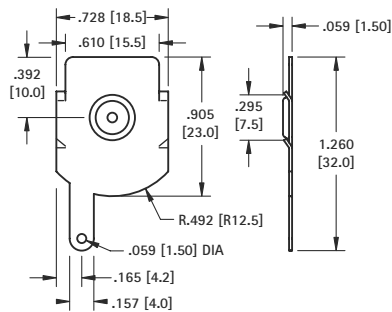

CAT. NO. 5250

(-) NEGATIVE SPRING

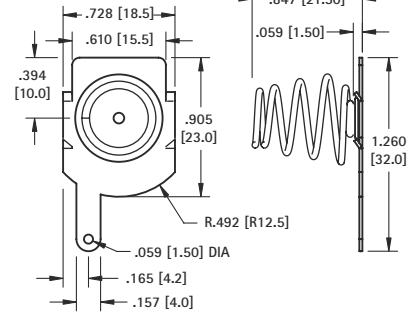

CAT. NO. 5251

DUAL CONTACT

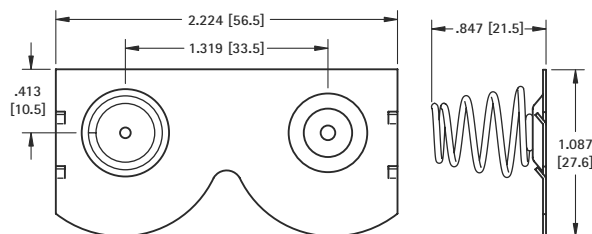

CAT. NO. 5253 Left

CAT. NO. 5252 Right (Shown)

"18650" LITHIUM-ION BATTERY HOLDERS

"18650" CELL



NOTE: PC Mount
Battery Clip Available
See Page 9.

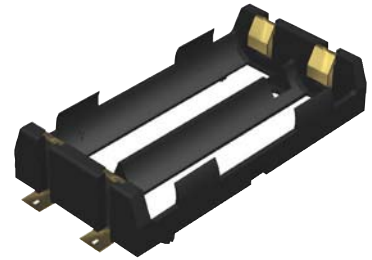

FEATURES

- Low profile surface mount holder for Cylindrical Lithium and alkaline batteries
- UL 94V-0 heat resistant nylon housing well suited for reflow soldering
- Battery installation and removal does not require tools

- Securely holds battery in place
- Polarity clearly marked for orientation
- Accommodates cells with or without built-in PCB protection circuits

Operating Temp Range:
-60°F to +290°F (-50°C to +145°C)

APPLICATIONS

- Computer memory, power backup systems
- Digital readers
- Laptop and touch pad computers
- PLC and industrial controls

THRU HOLE MOUNT

SINGLE CELL

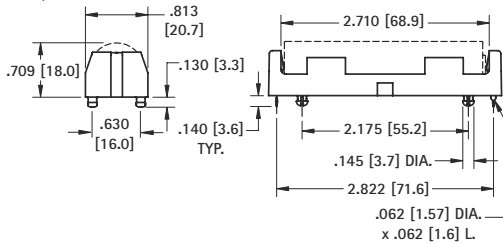

Mounting Detail

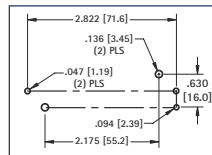

SPECIFICATIONS

Base: High Temp Nylon 46, UL 94V-0
Contacts: .012 (.30) Phosphor Bronze, Tin-Nickel Plate

CAT. NO. 1043

SURFACE MOUNT

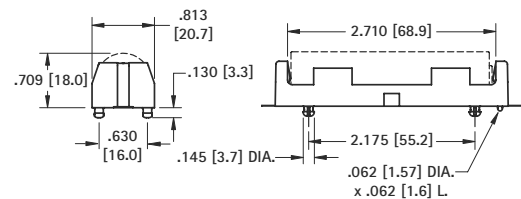

Pad Layout

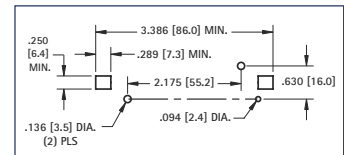

SPECIFICATIONS

Base: High Temp Nylon 46, UL 94V-0
Contacts: .012 (.30) Phosphor Bronze, Gold Plate (Flash)

CAT. NO. 1042

DUAL CELL

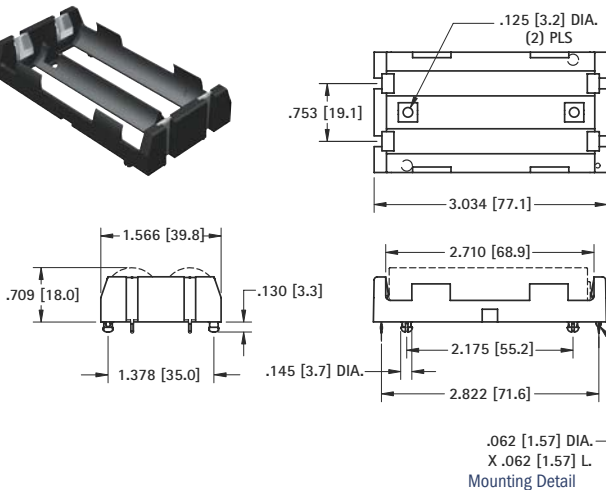

Mounting Detail

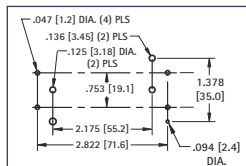

SPECIFICATIONS

Base: High Temp Nylon 46, UL 94V-0
Contacts: .012 (.30) Phosphor Bronze, Tin-Nickel Plate

CAT. NO. 1049

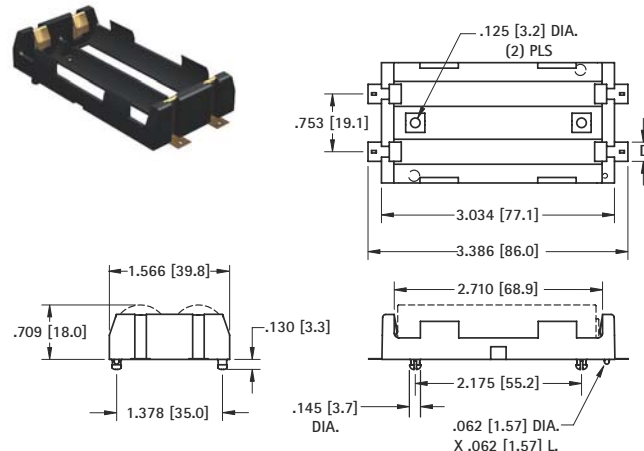

Pad Layout

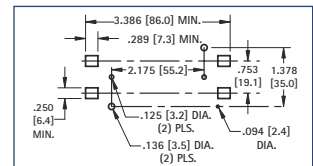

SPECIFICATIONS

Base: High Temp Nylon 46, UL 94V-0
Contacts: .012 (.30) Phosphor Bronze, Gold Plate (Flash)

CAT. NO. 1048

THM LOW PROFILE LITHIUM & ALKALINE CELL HOLDERS

"1/3N" · "AAA" · "1/2AA" · "CR2" · "AA" · "2/3A"

FEATURES

- Snap-In PC contact holds firmly in position for wave soldering
- Tin Nickel Plated contacts for excellent solderability and durability
- Polarity clearly marked for orientation
- Snap-on retainer cover (optional) retains battery securely to withstand shock and vibration. Helps protect against shorting. Tamper-proof.

APPLICATIONS

- Computer memory, power backup systems.
- Telecommunications
- Residential, industrial and commercial security systems
- PLC and industrial controls

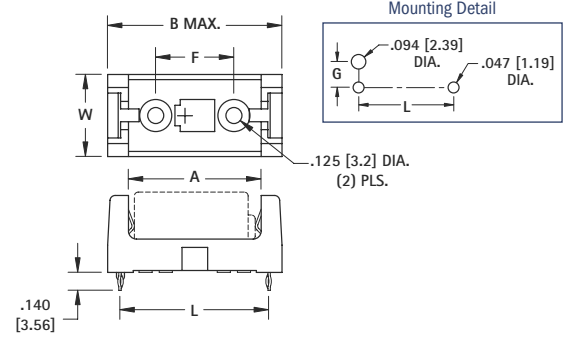

SPECIFICATIONS

Base/ Retainer Cover: PBT, UL 94V-0
 Contacts: .012 (.30) Stainless Steel, Tin-Nickel Plate
 Operating Temp Range: -60°F to +290°F (-50°C to +145°C)

HOLDER CAT. NO.	COVER CAT. NO.	L	W	H (Ref. Dim)	A	B (MAX)	F	G	CELL SIZE	BATTERY CROSS REFERENCE
108	108C	1.160 (29.5)	.640 (16.3)	.633 (16.1)	1.030 (26.2)	1.360 (34.5)	.610 (15.5)	.279 (7.1)	"1/2 AA" "CR2"	Energizer 544, CR2, Duracell PX28L, CR2, Kodak K28A & KS28, CR2, Panasonic CR14250, CR2, Saft LCP3, Maxell 4LR44, CR2, Sanyo CR14250SE, CR2
1028	1024C 1028C	2.160 (54.9)	.640 (16.3)	.633 (16.1)	2.040 (51.8)	2.360 (59.9)	1.610 (40.9)	.279 (7.1)	"AA"	Energizer, Duracell, Panasonic, Sanyo, Varta, Rayovac, Tadiran
1029	1029C 1029LC	1.500 (38.1)	.720 (18.3)	.712 (18.1)	1.375 (34.9)	1.700 (43.2)	.950 (24.1)	.320 (8.1)	"2/3 A"	Duracell DL2/3A, Kodak K123L, Panasonic CR123A, Saft 450SC & VR0450, Sanyo CR17335SE

THM ULTRA LOW PROFILE

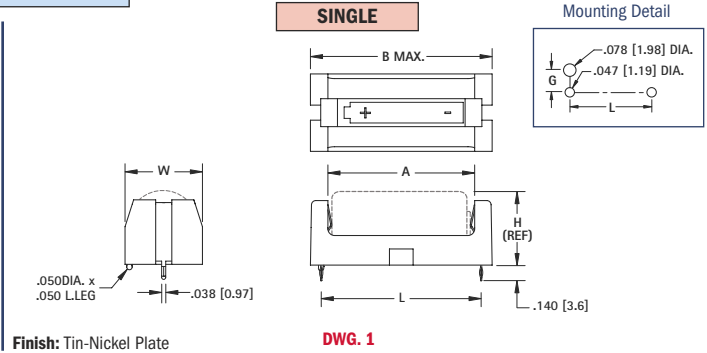
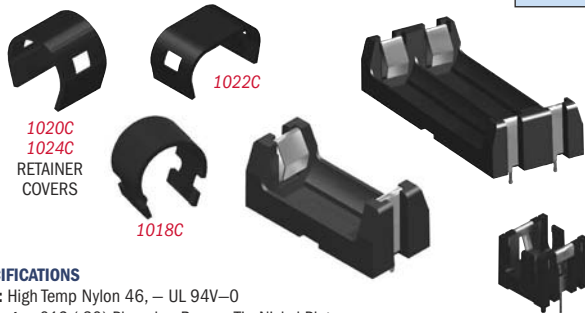

SPECIFICATIONS

Base: High Temp Nylon 46, - UL 94V-0
 Contacts: .012 (.30) Phosphor Bronze, Tin-Nickel Plate
 Operating Temp Range: -60°F to +290°F (-50°C to +145°C)

Finish: Tin-Nickel Plate

DWG. 1

DUAL

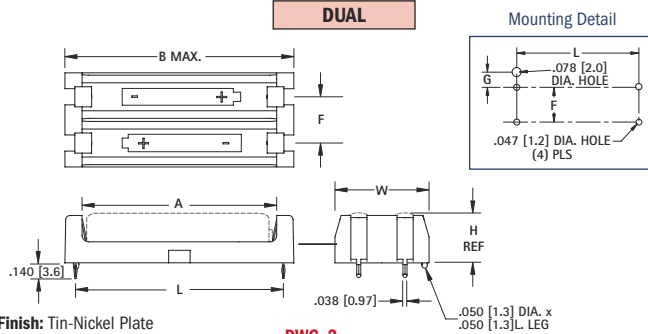

Finish: Tin-Nickel Plate

DWG. 2

"1/3N"

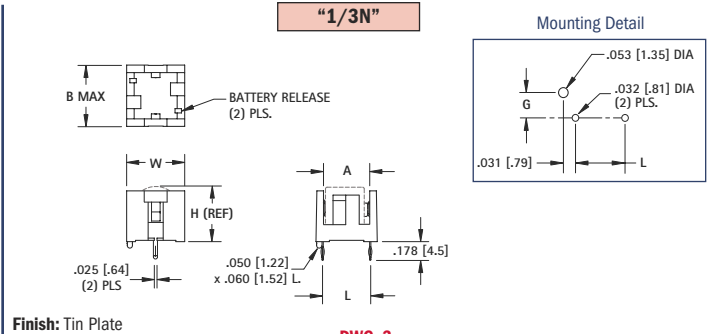

Finish: Tin Plate

DWG. 3

HOLDER CAT. NO.	COVER CAT. NO.	DWG NO.	L	W	H (Ref. Dim)	A	B (MAX)	F	G	CELL SIZE	BATTERY CROSS REFERENCE
1015	1024C	1	2.145 (54.5)	.612 (15.5)	.603 (15.3)	2.040 (51.8)	2.359 (59.9)	-	.265 (6.7)	"AA"	Energizer, Duracell, Panasonic, Sanyo, Varta, Rayovac, Tadiran
1013	1012C	2	2.145 (54.5)	1.180 (30.0)	.603 (15.3)	2.040 (51.8)	2.359 (59.9)	.568 (14.4)	.265 (6.7)	"AA"	Energizer, Duracell, Panasonic, Sanyo, Varta, Rayovac, Tadiran
1021	1020C	1	1.933 (49.1)	.500 (12.7)	.445 (11.3)	1.810 (46.0)	2.140 (54.4)	-	.209 (5.3)	"AAA"	Energizer, Duracell, Panasonic, Sanyo, Varta, Rayovac, Tadiran
1023	1022C	2	1.933 (49.1)	.875 (22.2)	.445 (11.3)	1.810 (46.0)	2.140 (54.4)	.430 (10.9)	.182 (4.6)	"AAA"	Energizer, Duracell, Panasonic, Sanyo, Varta, Rayovac, Tadiran
1019	1018C	1	1.487 (37.8)	.720 (18.3)	.682 (17.3)	1.365 (42.9)	1.690 (42.9)	-	.319 (8.1)	"2/3 A"	Duracell DL2/3A, Kodak K123L, Panasonic CR123A, Saft 450SC & VR0450, Sanyo CR17335SE
1017	1024C	1	1.156 (29.4)	.612 (15.5)	.603 (15.3)	1.030 (26.2)	1.360 (34.5)	-	.265 (6.7)	"1/2 AA"	Energizer 544, Duracell PX28L, Kodak K28A & KS28, Saft LCP3, Maxell 4LR44, Sanyo CR14250SE
503	-	3	.450 (11.4)	.540 (13.7)	.506 (12.9)	.430 (10.9)	.570 (14.5)	-	.240 (6.1)	"1/3 N"	Duracell DL1/3N, Sanyo K58L, Energizer CR1/3N

THM BATTERY HOLDERS

SMT LOW PROFILE LITHIUM & ALKALINE CELL HOLDERS

"1/3N" · "AAA" · "1/2AA" · "AA" · "2/3A"

AVAILABLE ON TAPE AND REEL

FEATURES

- Low profile surface mount holders for Cylindrical Lithium and Alkaline batteries
- UL 94V-0 Heat resistant Nylon Housings well suited for reflow soldering
- Designed for vacuum pick and place assembly
- Gold-plated Phosphor Bronze contacts assure low contact resistance and are readily solderable

- Ideal for both lead free solder and traditional solder process
- Battery installation and removal does not require tools
- Securely holds battery in place
- Polarity clearly marked for orientation
- Operating temp range: -60°F to +290°F (-50°C to +145°C)

APPLICATIONS

- Computer memory, power backup systems
- Telecommunications
- Residential, industrial and commercial security systems
- PLC and industrial controls

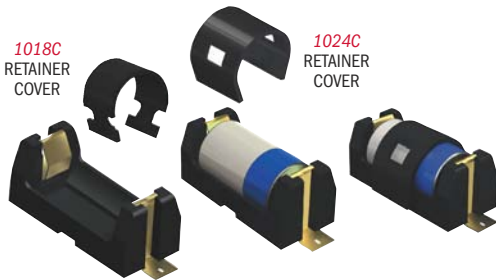

SMT ULTRA LOW PROFILE

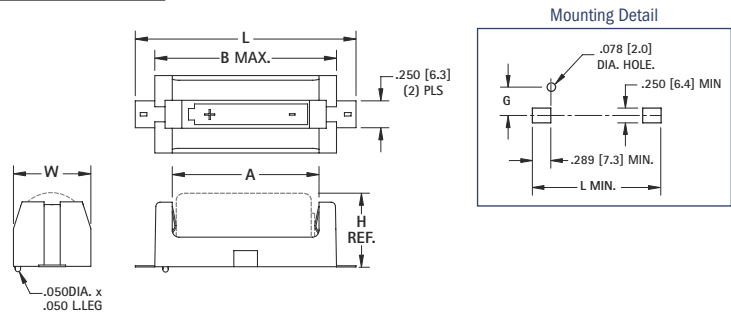

SPECIFICATIONS

Base: High Temp Nylon 46, UL 94V-0

Contacts: .012 (.30) Phosphor Bronze, Gold Plate (Flash)

CAT. NO.	ON TAPE BULK	ON TAPE & REEL	COVER	L	W	H (REF)	A	B (MAX)	G	CELL SIZE	TAPE & REEL SPECS PACKED ON 13" REEL	BATTERY CROSS REFERENCE
1016	1016TR	1024C	1024C	1.723 (43.8)	.612 (15.5)	.603 (15.3)	1.030 (26.2)	1.360 (34.5)	.265 (6.7)	"1/2 AA"	56mm wide, 24mm pitch, 125 pcs/reel	Energizer 544, Duracell PX28L, Kodak K28A & KS28, Panasonic CR14250, Saft LCP3, Maxell 4LR44, Sanyo CR14250SE
1024	1024TR	1024C	1024C	2.711 (68.9)	.612 (15.5)	.603 (15.3)	2.040 (51.8)	2.359 (59.9)	.265 (6.7)	"AA"	88mm wide, 28mm pitch, 100 pcs/reel	Energizer, Duracell, Panasonic, Sanyo, Varta, Rayovac, Tadiran
1018	1018TR	1018C	1018C	2.053 (52.2)	.720 (18.3)	.682 (17.3)	1.365 (34.7)	1.690 (42.9)	.319 (8.1)	"2/3 A"	72mm wide, 32mm pitch, 100 pcs/reel	Duracell DL2/3A, Kodak K123L, Panasonic CR123A, Saft 450SC & VR0450, Sanyo CR17335SE

SMT ULTRA LOW PROFILE



SINGLE

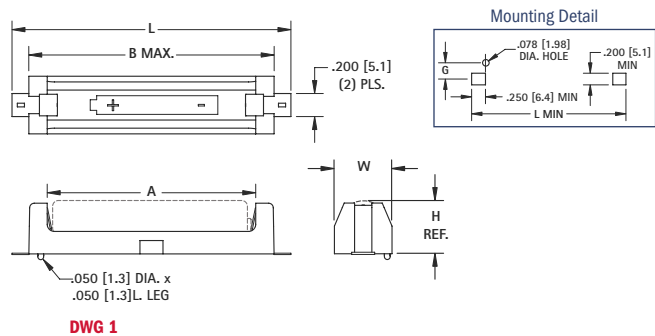

SPECIFICATIONS

Base: High Temp Nylon 46, UL 94V-0

Contacts: .012 (.30) Phosphor Bronze, Gold Plate (Flash)

Operating Temp: -60°F to +290°F (-50°C to +145°C)

DUAL

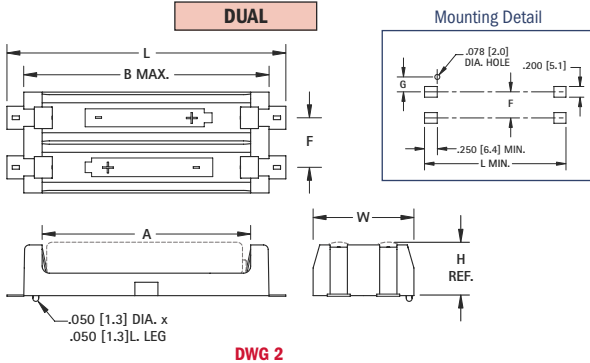

DWG 2

"1/3N"

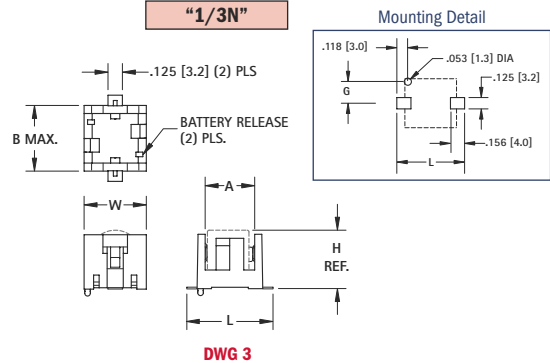

DWG 3

CAT. NO.	ON TAPE BULK	ON TAPE & REEL	COVER	DWG NO.	L	W	H (REF)	A	B (MAX)	F	G	CELL SIZE	TAPE AND REEL SPECS PACKED ON 13" REEL	BATTERY CROSS REFERENCE
1020	1020TR	1020C	1020C	1	2.421 (61.5)	.500 (12.7)	.445 (11.3)	1.810 (46.0)	2.140 (54.4)	-	.209 (5.3)	"AAA"	88mm Wide, 24mm pitch, 200 pcs/reel	Energizer, Duracell, Panasonic, Sanyo, Varta, Rayovac, Tadiran
1022	1022TR	1022C	1022C	2	2.421 (61.5)	.875 (22.2)	.445 (11.3)	1.810 (46.0)	2.140 (54.4)	.430 (10.9)	.182 (4.6)	"AAA"	88mm Wide, 32mm pitch, 125 pcs/reel	Energizer, Duracell, Panasonic, Sanyo, Varta, Rayovac, Tadiran
1024	1024TR	1024C	1024C	1	2.711 (68.9)	.612 (15.5)	.603 (15.3)	2.040 (51.8)	2.359 (59.9)	-	.265 (6.7)	"AA"	88mm wide, 28mm pitch, 100 pcs/reel	Energizer, Duracell, Panasonic, Sanyo, Varta, Rayovac, Tadiran
1012	1012TR	1012C	1012C	2	2.711 (68.9)	1.180 (30.0)	.603 (15.3)	2.040 (51.8)	2.359 (59.9)	.568 (14.4)	.265 (6.7)	"AA"	88mm Wide, 48mm pitch, 100 pcs/reel	Energizer, Duracell, Panasonic, Sanyo, Varta, Rayovac, Tadiran
498	498TR	-	-	3	.748 (19.0)	.540 (13.7)	.506 (12.9)	.430 (10.9)	.570 (14.5)	-	.240 (6.1)	"1/3 N"	44mm Wide, 24mm pitch, 125 pcs/reel	Duracell DL1/3N, Sanyo K58L, Energizer CR1/3N

SMT & THM POLARIZED LITHIUM CELL HOLDERS

“CR2” - “CR123A”

FEATURES

- Low profile surface mount and Thru Hole Mount Holders for Lithium batteries
- UL 94V-0 Heat resistant Nylon Housings well suited for reflow or wave soldering.

- Battery installation and removal does not require tools.
- Securely holds battery in place
- Polarized holder offers circuit protection against improper battery installation

APPLICATIONS

- Computer memory, power backup systems
- Telecommunications
- Residential, industrial security systems
- PLC and industrial controls

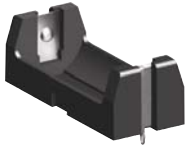

Thru-Hole Mount (THM)

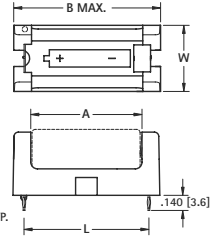
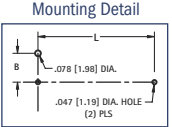
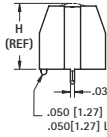

1018C
RETAINER
COVER
FITS ALL
HOLDERS

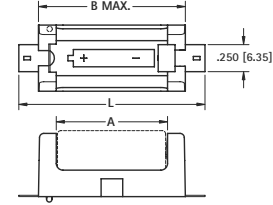
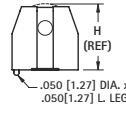

Surface Mount (SMT)

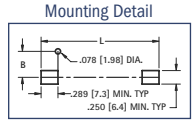

SPECIFICATIONS

Base: High Temp Nylon 46, UL Rated 94V-0

Contacts: .012 (1.30) Phosphor Bronze, Gold Plate (Flash) - SMT

.012 (1.30) Phosphor Bronze, Tin-Nickel Plate - THM

Operating temp range: -60°F to 290°F (-50°C to 145°C)

CAT. NO.	MOUNTING STYLE	L	W	H (Ref)	A	B (MAX)	G	CELL SIZE
1010	SMT	1.723 (43.8)	.612 (15.5)	.661 (16.8)	1.030 (26.2)	1.360 (34.5)	.265 (6.7)	CR2
1011	THM	1.156 (29.4)						
1050	SMT	2.062 (52.4)						
1051	THM	1.487 (37.8)	.720 (18.3)	.712 (18.1)	1.365 (34.7)	1.690 (42.9)	.319 (8.1)	CR123A

RUGGED STEEL & ALUMINUM LITHIUM CELL HOLDERS

- Sturdily constructed of quality materials
- Contacts made from Brass, Nickel Plate
- Ideal for punishing applications

STEEL HOLDERS “1/2AA”



CAT. NO. 2103

CAT. NO. 1103

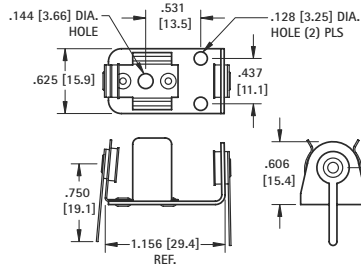

BATTERY CROSS REFERENCE

Energizer: 544, **Duracell:** PX28L, **Kodak:** K28A & KS28, **Panasonic:** CR14250, **Sanyo:** CR14250SE, **Saft:** LCP3, **Maxell:** 4LR44

Mounting Detail

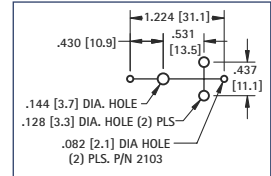

ALUMINUM HOLDERS “2/3A”

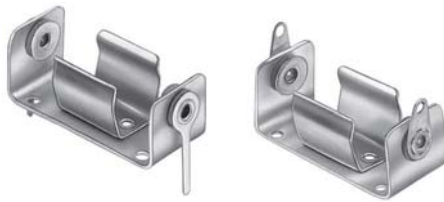

CAT. NO. 131

CAT. NO. 132

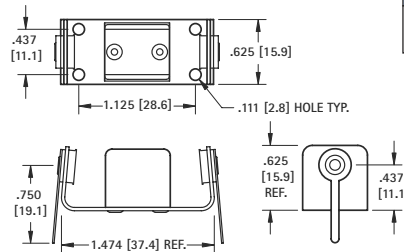

BATTERY CROSS REFERENCE

Duracell: DL2/3A, **Kodak:** K123L, **Sanyo:** CR173335SE, **Saft:** 450SC & VR0450

Mounting Detail

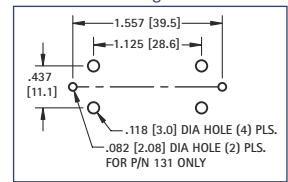

6 VOLT LITHIUM CELL HOLDERS



- Polarizing Tab for proper orientation
- Lightweight, ideal for rugged applications
- DL223A or Equivalent Batteries

SPECIFICATIONS

Frame: Aluminum 2024-T3 **Terminals:** Brass, Tin Plate

Spring Contacts: .025 (.64) Dia. Spring Steel, Nickel Plate

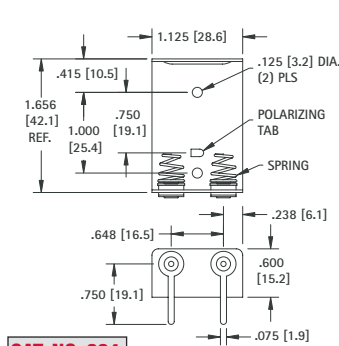

CAT. NO. 224

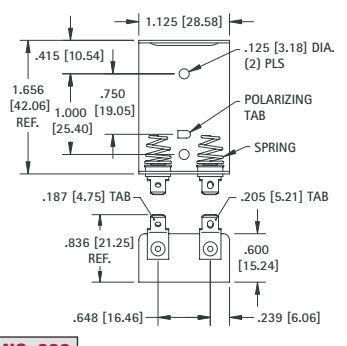

CAT. NO. 223

ALUMINUM HOLDERS CONNECTED IN SERIES

ELIMINATES WIRING · LABOR SAVING

Features pre-connected jumper strap insulated from the Aluminum base. Batteries held in series circuit without need of additional wiring.

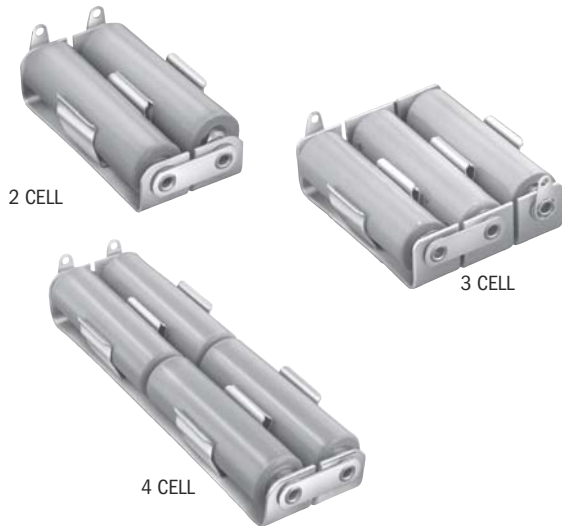

CAT. NO.	HOLDS NO. OF CELLS	BATTERY CROSS REFERENCE		
		IEC	ANSI/NEDA	
"AA" CELL		(BATTERY .531 (13.4) O.D. x 1.906 (48.4) L) SIZE .565 (14.5) 1.988 (50.5)		
146	2	LR6	15A	Energizer, Duracell, Panasonic, Sanyo, Varta, Rayovac, Tadiran
147	3			
148	4			
"C" CELL		(BATTERY .875 (22.2) O.D. x 1.875 (47.6) L) SIZE 1.125 (28.6) 1.969 (50.0)		
149	2	LR14	14A	Energizer, Duracell, Panasonic, Sanyo, Varta, Rayovac, Tadiran
150	3			
151	4			
"D" CELL		(BATTERY 1.187 (30.1) O.D. x 2.312 (58.7) L) SIZE 1.375 (34.9) 2.412 (61.3)		
152	2	LR20	13A	Energizer, Duracell, Panasonic, Sanyo, Varta, Rayovac, Tadiran
153	3			
158	4			

ALUMINUM HOLDERS WITH PC LUGS

ELIMINATES WIRING · LABOR SAVING

For printed circuitry we have standardized our most popular holders with PC Lugs. Choice of single or multiple holders "AA" assembled with Cat. No. 4002 lug. "C" and "D" assembled with Cat. No. 4003 lug.

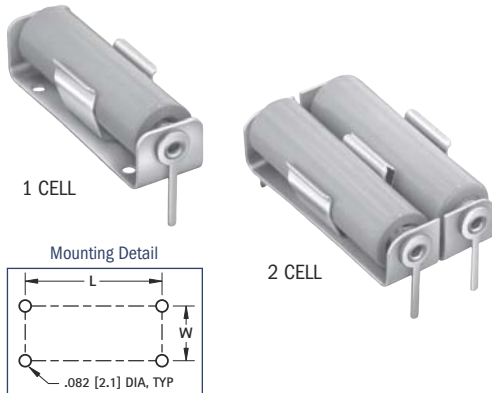

CAT. NO.	HOLDS NO. OF CELLS	MOUNTING HOLE DETAILS		BATTERY CROSS REFERENCE	
		L	W	IEC	ANSI/NEDA
"AA" CELL		(BATTERY .531 (13.4) O.D. x 1.906 (48.4) L) SIZE .565 (14.5) 1.988 (50.5)			
2222	1	2.250 (57.2)	—	LR6	15A
2223	2	2.250 (57.2)	.625 (15.9)		
"C" CELL		(BATTERY .875 (22.2) O.D. x 1.875 (47.6) L) SIZE 1.125 (28.6) 1.969 (50.0)			
2224	1	2.218 (56.3)	—	LR14	14A
2225	2	2.218 (56.3)	1.000 (25.4)		
"D" CELL		(BATTERY 1.187 (30.1) O.D. x 2.312 (58.7) L) SIZE 1.375 (34.9) 2.412 (61.3)			
2226	1	2.687 (68.3)	—	LR20	13A
2227	2	2.687 (68.3)	1.312 (33.3)		

STEEL HOLDERS WITH PC LUGS

ELIMINATES WIRING · LABOR SAVING

For printed circuitry we have standardized our most popular holders with PC Lugs. Choice of single or multiple holders "AA" assembled with Cat. No. 4002 lug. "C" and "D" assembled with Cat. No. 4003 lug.

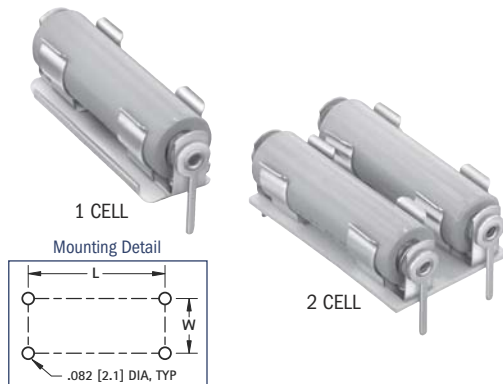

CAT. NO.	HOLDS NO. OF CELLS	MOUNTING HOLE PATTERN		BATTERY CROSS REFERENCE	
		L	W	IEC	ANSI/NEDA
"AA" CELL		(BATTERY .531 (13.4) O.D. x 1.906 (48.4) L) SIZE .565 (14.5) 1.988 (50.5)			
2228	1	2.203 (56.0)	—	LR6	15A
2229	2	2.203 (56.0)	.750 (19.1)		
"C" CELL		(BATTERY .875 (22.2) O.D. x 1.875 (47.6) L) SIZE 1.125 (28.6) 1.969 (50.0)			
2230	1	2.343 (59.5)	—	LR14	14A
2231	2	2.343 (59.5)	1.187 (30.2)		
"D" CELL		(BATTERY 1.187 (30.1) O.D. x 2.312 (58.7) L) SIZE 1.375 (34.9) 2.412 (61.3)			
2232	1	2.625 (66.7)	—	LR20	13A
2233	2	2.625 (66.7)	1.562 (39.7)		

RUGGED & LIGHTWEIGHT ALUMINUM BATTERY HOLDERS



Lightweight yet strong, constructed of aircraft grade aluminum. Batteries snap-fit securely into clips.

Contacts: Brass, Nickel Plate

Lugs: Brass, Tin Plate

Frame and Battery Clips: Aluminum

Insulating Washers: Moisture Proof Resin impregnated fiber

MODIFICATIONS

We welcome the opportunity to quote on variations of standard items. Use our engineering service for your custom-built holders. Holders with PC and Quick-Fit terminals available on special order.

ALUMINUM BATTERY HOLDERS

CAT. NO.	HOLDS NO. OF CELLS	FIG. NO.	BATTERY CROSS REFERENCE		
			IEC	ANSI/NEDA	MANUFACTURERS
"AAA" CELL (BATTERY SIZE $\frac{.375 (9.5)}{.468 (11.9)}$ O.D. \times $\frac{1.673 (42.5)}{1.752 (44.5)}$ L)					
137	1	1	LR03	24A	Energizer, Duracell, Panasonic, Sanyo, Varta, Rayovac, Tadiran
138	2	3			
169	3	3			
170	4	3			
"AA" CELL (BATTERY SIZE $\frac{.531 (13.4)}{.565 (14.5)}$ O.D. \times $\frac{1.906 (48.4)}{1.988 (50.5)}$ L)					
139	1	1	LR6	15A	Energizer, Duracell, Panasonic, Sanyo, Varta, Rayovac, Tadiran
140	2	3			
171	3	3			
182	4	3			
189	2	2			
192	4	4			
193	6	4			
"C" CELL (BATTERY SIZE $\frac{.875 (22.2)}{1.125 (28.6)}$ O.D. \times $\frac{1.875 (47.6)}{1.969 (50.0)}$ L)					
173	1	1	LR14	14A	Energizer, Duracell, Panasonic, Sanyo, Varta, Rayovac, Tadiran
174	2	3*			
185	2	2			
187	3	3			
196	4	4**			
197	6	4			
"D" CELL (BATTERY SIZE $\frac{1.187 (30.1)}{1.375 (34.9)}$ O.D. \times $\frac{2.312 (58.7)}{2.412 (61.3)}$ L)					
175	1	1	LR20	13A	Energizer, Duracell, Panasonic, Sanyo, Varta, Rayovac, Tadiran
176	2	3*			
186	2	2			
190	3	3			
200	4	4**			
201	6	4			
205	6	4***			
"N" OR "12V" CELL (BATTERY SIZE $\frac{.375 (9.5)}{.468 (11.9)}$ O.D. \times $\frac{1.110 (28.2)}{1.189 (30.2)}$ L)					
154	1	1	LR1	910A	Energizer, Duracell, Panasonic, Sanyo, Varta, Rayovac, Tadiran
155	2	3			
156	3	3			
LITHIUM "2/3A" OR "CR123" CELL					
132	1	1	CR17345	5018LC	All major manufactures
"9 VOLT" BATTERY					
203P	REF. PAGE 31		6LR61	1604A, 1604LC, 11604 7.2H5	Energizer, Duracell, Panasonic, Sanyo, Varta, Rayovac, Tadiran
1290					
1290-79					
1290-66					

* 1 Single clip holds 2 batteries in place. ** 2 Clips hold 4 batteries in place. *** 3 Clips hold 6 batteries in place.

FIG. 1



1 CELL

FIG. 2



2 CELL

FIG. 3



2 CELL

FIG. 4

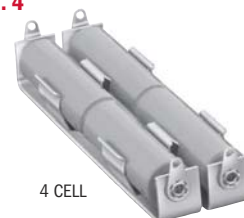

4 CELL



3 CELL



6 CELL
CAT. NO. 193
CAT. NO. 197



4 CELL



6 CELL
CAT. NO. 205

DIMENSIONAL DRAWINGS FOR ALUMINUM BATTERY HOLDERS

MATERIAL SPECIFICATIONS

Insulating Washers: Moisture proof, resin impregnated fibre
Terminal Lugs: Brass, Tin Plate

Frame and Clips: Aluminum 2024-T3
Contact Eyelet: Brass, Nickel Plate

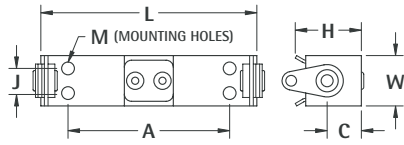

DWG. 1

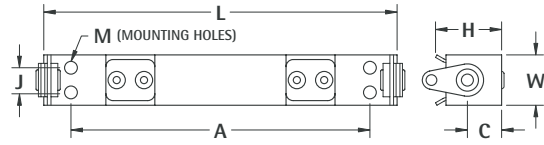

DWG. 2

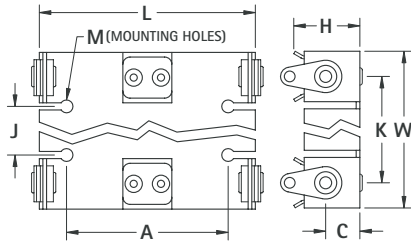

DWG. 3

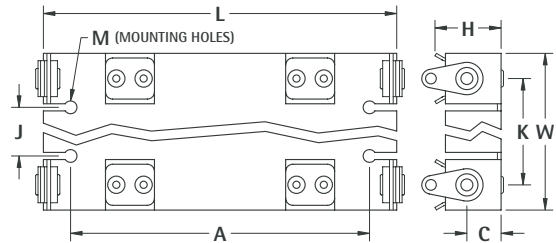

DWG. 4

CAT. NO.	DWG. NO.	W	L	H	C	K	J	A	M
		Width Of Base	Length Of Base	Height Of Base	Height to Battery Center Height	Distance Between Battery Contacts	Mounting Holes Width	Mounting Holes Length	Mounting Holes (Diameter)
"AAA" CELL									
137	1	.437 (11.1)	1.915 (48.6)	.467 (11.9)	.281 (7.1)	—	.250 (6.4)	1.500 (38.1)	.111 (2.8)
138	3	.812 (20.6)	1.915 (48.6)	.467 (11.9)	.281 (7.1)	.437 (11.1)	—	.875 (22.2)	.144 (3.7)
169	3	1.250 (31.8)	1.915 (48.6)	.467 (11.9)	.281 (7.1)	.437 (11.1)	.438 (11.1)	.875 (22.2)	.144 (3.7)
170	3	1.687 (42.8)	1.915 (48.6)	.467 (11.9)	.281 (7.1)	.437 (11.1)	.875 (22.2)	.875 (22.2)	.144 (3.7)
"AA" CELL									
139	1	.625 (15.9)	2.140 (54.4)	.578 (14.7)	.392 (10.0)	—	.406 (10.3)	1.500 (38.1)	.111 (2.8)
140	3	1.125 (28.6)	2.156 (54.8)	.562 (14.3)	.375 (9.5)	.625 (15.9)	—	1.218 (30.9)	.144 (3.7)
171	3	1.750 (44.5)	2.140 (54.4)	.578 (14.7)	.392 (10.0)	.625 (15.9)	.625 (15.9)	1.218 (30.9)	.144 (3.7)
182	3	2.656 (67.5)	2.140 (54.4)	.615 (15.6)	.421 (10.7)	.718 (18.2)	1.437 (36.5)	1.218 (30.9)	.144 (3.7)
189	2	.625 (15.9)	4.110 (104.4)	.593 (15.1)	.406 (10.3)	—	.437 (11.1)	3.000 (76.2)	.128 (3.3)
192	4	1.125 (28.6)	4.093 (104.0)	.593 (15.1)	.406 (10.3)	.625 (15.9)	—	3.093 (78.6)	.144 (3.7)
193	4	1.750 (44.5)	4.093 (104.0)	.593 (15.1)	.406 (10.3)	.625 (15.9)	.625 (15.9)	3.125 (79.4)	.144 (3.7)
"C" CELL									
173	1	.750 (19.1)	2.093 (53.2)	.968 (24.6)	.613 (15.6)	—	.437 (11.1)	1.500 (38.1)	.144 (3.7)
174	3*	1.625 (41.3)	2.093 (53.2)	1.120 (28.4)	.613 (15.6)	1.000 (25.4)	—	1.250 (31.75)	.144 (3.7)
185	2	.750 (19.1)	4.046 (102.8)	.968 (24.6)	.593 (15.1)	—	.500 (12.7)	3.187 (80.9)	.144 (3.7)
187	3	2.840 (72.1)	2.125 (54.0)	.968 (24.6)	.593 (15.1)	1.125 (28.6)	1.125 (28.6)	1.250 (31.8)	.144 (3.7)
196	4**	1.625 (41.3)	4.075 (103.5)	1.120 (28.4)	.593 (15.1)	1.000 (25.4)	—	3.187 (80.9)	.144 (3.7)
197	4	2.875 (73.0)	4.075 (103.5)	.968 (24.6)	.593 (15.1)	1.150 (29.2)	1.000 (25.4)	3.187 (80.9)	.144 (3.7)
"D" CELL									
175	1	1.000 (25.4)	2.562 (65.1)	1.262 (32.1)	.763 (19.4)	—	.750 (19.1)	1.750 (44.5)	.128 (3.3)
176	3*	2.062 (52.4)	2.562 (65.1)	1.468 (37.3)	.741 (18.8)	1.312 (33.3)	—	1.500 (38.1)	.144 (3.7)
186	2	1.000 (25.4)	4.921 (125.0)	1.262 (32.1)	.747 (19.0)	—	.687 (17.4)	4.125 (104.8)	.128 (3.3)
190	3	3.375 (85.7)	2.562 (65.1)	1.262 (32.1)	.775 (19.7)	1.350 (34.3)	1.125 (28.6)	1.937 (49.2)	.144 (3.7)
200	4**	2.062 (52.4)	4.870 (123.7)	1.468 (37.3)	.741 (18.8)	1.312 (33.3)	—	4.375 (111.1)	.144 (3.7)
201	4	3.375 (85.7)	4.920 (125.0)	1.262 (32.1)	.775 (19.7)	1.343 (34.1)	1.125 (28.6)	4.250 (108.0)	.144 (3.7)
205	4***	2.062 (52.4)	7.270 (184.7)	1.468 (37.3)	.741 (18.8)	1.312 (33.3)	—	6.750 (171.5)	.144 (3.7)
"N" OR "12V" CELL									
154	1	.437 (11.1)	1.328 (33.7)	.483 (12.3)	.297 (7.5)	—	.250 (6.4)	.906 (23.0)	.111 (2.8)
155	3	.937 (23.8)	1.347 (34.2)	.483 (12.3)	.297 (7.5)	.500 (12.7)	—	.875 (22.2)	.128 (3.3)
156	3	1.500 (38.1)	1.347 (34.2)	.483 (12.3)	.297 (7.5)	.531 (13.5)	.562 (14.3)	.875 (22.2)	.111 (2.8)
"2/3A" CELL									
132	1	.625 (15.9)	1.474 (37.4)	.625 (15.9)	.437 (11.1)	—	.437 (11.1)	1.125 (28.6)	.111 (2.8)
"9 VOLT" BATTERY									
203-P	1	1.125 (28.6)	2.000 (50.8)	.797 (20.2)	—	—	—	—	—
1290	1	1.125 (28.6)	1.900 (48.3)	.718 (18.2)	—	—	—	—	—
1290-66	1*	1.125 (28.6)	1.900 (48.3)	.857 (21.8)	—	—	—	—	—
1290-79	1	1.125 (28.6)	1.900 (48.3)	.812 (20.6)	—	—	—	—	—

* 1 Single clip holds both batteries in place. ** 2 Clips hold four batteries in place. *** 3 Clips hold six batteries in place.

DIMENSIONS ARE FOR REFERENCE ONLY

RUGGED STEEL BATTERY HOLDERS



An established design that has gained wide acceptance for commercial and military applications. Batteries are held under constant spring tension assuring low contact resistance. Retainer clips are available to lock batteries in place and prevent shifting or loosening. Refer to page 10. Recommended for use where shock or severe vibration is encountered. Special fabrication for more than four batteries or variations from standard stock parts can be assembled to meet your requirements.

- Ideal for NiCd, Alkaline, NiMH, Carbon, Zinc and Lithium Cells
- Corrosion Resistant, Nickel Plate
- Brass Contacts, Nickel Plate
- Moisture Proof Resin Impregnated, Fibre Insulating Washers

FIG. 1 STAINLESS STEEL BASE. INSULATOR TUBES SUPPLIED FOR 2-3-4 CELLS (END TO END)

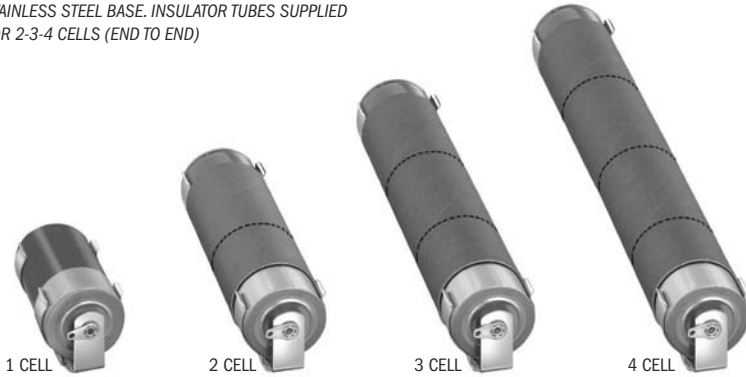

FIG. 2 STEEL BASE. LITHIUM (SINGLE CELL)



FIG. 3 PHENOLIC BASE FOR 2, 3, 4 CELLS (SIDE BY SIDE)



STEEL BATTERY HOLDERS

1100 SERIES	2100 SERIES	HOLDS NO. OF CELLS	FIG. NO.	BATTERY CROSS REFERENCE		
ONE CONTACT INSULATED CAT. NO.	ALL CONTACTS INSULATED CAT. NO.			IEC	ANSI/NEDA	BATTERY MANUFACTURERS
"AA" CELL				(BATTERY SIZE .531 (13.4) O.D. x 1.906 (48.4) L) (SIZE .565 (14.5) O.D. x 1.988 (50.5) L)		
1139	2139	1	1	LR6	15A	Energizer, Duracell, Panasonic, Sanyo, Varta, Rayovac, Tadiran
—	2140*	2	3			
—	2171*	3	3			
—	2182*	4	3			
1189	2189	2	1			
1191	2191	3	1			
1194	2194	4	1			
"C" CELL				(BATTERY SIZE .875 (22.2) O.D. x 1.875 (47.6) L) (SIZE 1.125 (28.6) O.D. x 1.969 (50.0) L)		
1173	2173	1	1	LR14	14A	Energizer, Duracell, Panasonic, Sanyo, Varta, Rayovac, Tadiran
—	2174*	2	3			
—	2187*	3	3			
—	2188*	4	3			
1185	2185	2	1			
1195	2195	3	1			
1198	2198	4	1			
"D" CELL				(BATTERY SIZE 1.187 (30.1) O.D. x 2.312 (58.7) L) (SIZE 1.375 (34.9) O.D. x 2.412 (61.3) L)		
1175	2175	1	1	LR20	13A	Energizer, Duracell, Panasonic, Sanyo, Varta, Rayovac, Tadiran
—	2176*	2	3			
—	2190*	3	3			
—	2192*	4	3			
1186	2186	2	1			
1199	2199	3	1			
1162	2162	4	1			
"1/2AA" LITHIUM CELL				(BATTERY SIZE .475 (12.1) O.D. x .965 (24.5) L) (SIZE .510 (13.0) O.D. x .992 (25.2) L)		
—	1103	1	2	CR1108	1406LC	Energizer 544, Duracell PX28L, Panasonic CR14250

*Clips mounted on .062 (1.57) thick Phenolic board.

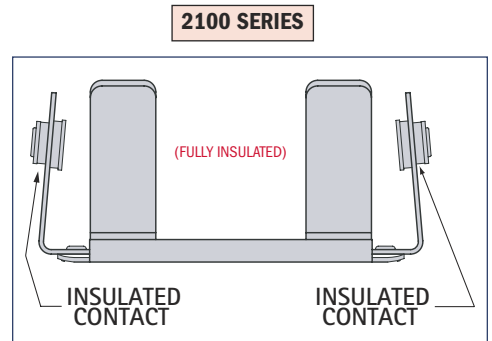
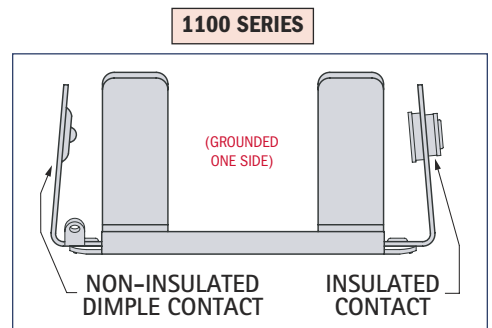

MODIFICATIONS

We welcome the opportunity to quote on variations of standard items. Use our engineering service for your custom-built holders. Holders with PC and Quick-Fit terminals available on special order.

DIMENSIONAL DRAWINGS FOR STEEL BATTERY HOLDERS

MATERIAL SPECIFICATIONS:

Clips: Spring Steel, Nickel Plate
Contact Eyelets: Brass, Nickel Plate
Insulating Washers: Resin Impregnated Fibre
Solder Lugs: Brass, Tin Plate

Phenolic Base: Type PBE, Per MIL-P-3115C
Stainless Steel Base: Ribbed, For Added Support
Steel Base: Spring Steel, Nickel Plate

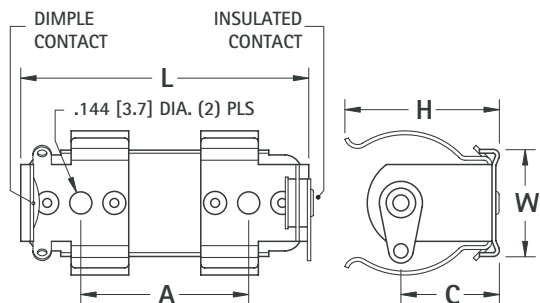

DWG. 1 1100 SERIES STAINLESS STEEL BASE (END-TO-END)

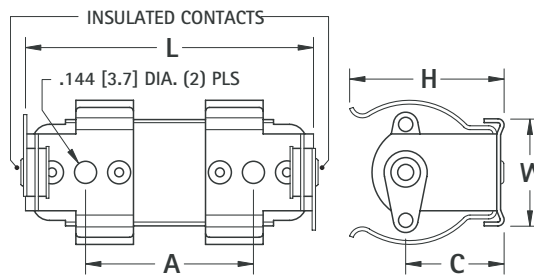

DWG. 1 2100 SERIES STAINLESS STEEL BASE (END-TO-END)

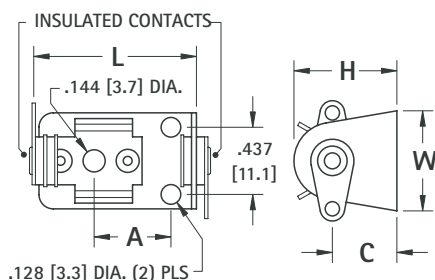

DWG. 2 "1/2AA" LITHIUM STEEL BASE (SINGLE CELL)

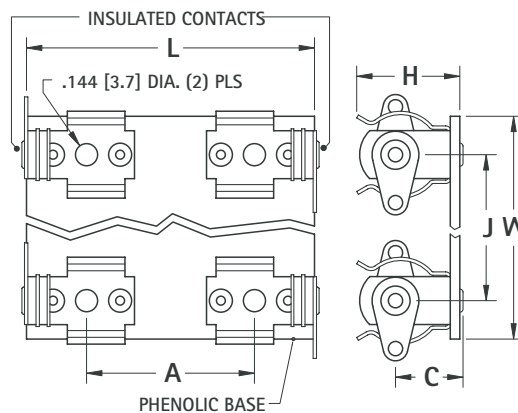

DWG. 3 2100 SERIES PHENOLIC BASE (SIDE-BY-SIDE)

1100 SERIES ONE CONTACT INSULATED CAT. NO.	2100 SERIES ALL CONTACTS INSULATED CAT. NO.	HOLDS NO. OF CELLS	DWG. NO.	W Width Of Base	L Length Of Base	H Height Of Holder	C Height to Battery Center	J Mounting Hole Distance	A Mounting Holes CTR To CTR
"AA" CELL									
1139	2139	1	1	.687 (17.4)	2.125 (54.0)	.656 (16.7)	.437 (11.1)	—	1.343 (34.1)
—	2140*	2	3	1.250 (31.8)	2.125 (54.0)	.656 (16.7)	.437 (11.1)	.750 (19.1)	1.343 (34.1)
—	2171*	3	3	2.000 (50.8)	2.125 (54.0)	.656 (16.7)	.437 (11.1)	.750 (19.1)	1.343 (34.1)
—	2182*	4	3	2.750 (69.9)	2.125 (54.0)	.656 (16.7)	.437 (11.1)	.750 (19.1)	1.343 (34.1)
1189	2189	2	1	.687 (17.4)	4.093 (104.0)	.656 (16.7)	.437 (11.1)	—	3.312 (84.1)
1191	2191	3	1	.687 (17.4)	6.030 (153.2)	.656 (16.7)	.437 (11.1)	—	5.250 (133.4)
1194	2194	4	1	.687 (17.4)	8.010 (203.5)	.656 (16.7)	.437 (11.1)	—	7.230 (183.6)
"C" CELL									
1173	2173	1	1	.687 (17.4)	2.125 (54.0)	1.000 (25.4)	.625 (15.9)	—	1.343 (34.1)
—	2174*	2	3	1.750 (44.5)	2.062 (52.4)	1.000 (25.4)	.625 (15.9)	1.187 (30.1)	1.343 (34.1)
—	2187*	3	3	2.937 (74.6)	2.062 (52.4)	1.000 (25.4)	.625 (15.9)	1.187 (30.1)	1.343 (34.1)
—	2188*	4	3	4.125 (104.8)	2.062 (52.4)	1.000 (25.4)	.625 (15.9)	1.187 (30.1)	1.343 (34.1)
1185	2185	2	1	.687 (17.4)	4.093 (104.0)	1.000 (25.4)	.625 (15.9)	—	3.312 (84.1)
1195	2195	3	1	.687 (17.4)	5.937 (150.8)	1.000 (25.4)	.625 (15.9)	—	5.156 (131.0)
1198	2198	4	1	.687 (17.4)	7.906 (200.8)	1.000 (25.4)	.625 (15.9)	—	7.125 (181.0)
"D" CELL									
1175	2175	1	1	.687 (17.4)	2.562 (65.1)	1.281 (32.5)	.796 (20.2)	—	1.625 (41.3)
—	2176*	2	3	2.125 (54.0)	2.562 (65.1)	1.281 (32.5)	.796 (20.2)	1.562 (39.7)	1.625 (41.3)
—	2190*	3	3	3.687 (93.6)	2.562 (65.1)	1.281 (32.5)	.796 (20.2)	1.562 (39.7)	1.625 (41.3)
—	2192*	4	3	5.250 (133.4)	2.562 (65.1)	1.281 (32.5)	.796 (20.2)	1.562 (39.7)	1.625 (41.3)
1186	2186	2	1	.687 (17.4)	4.937 (125.4)	1.281 (32.5)	.796 (20.2)	—	4.000 (101.6)
1199	2199	3	1	.687 (17.4)	7.281 (184.9)	1.281 (32.5)	.796 (20.2)	—	6.343 (161.1)
1162	2162	4	1	.687 (17.4)	9.625 (244.5)	1.281 (32.5)	.796 (20.2)	—	8.687 (220.6)
"1/2AA" LITHIUM CELL									
1103		1	2	.625 (15.9)	1.156 (29.4)	.595 (15.1)	.345 (8.8)	—	.531 (13.5)

*Clips mounted on .062 (1.57) Thick, Phenolic board.

DIMENSIONS ARE FOR REFERENCE ONLY

ECONOMICAL PLASTIC BATTERY HOLDERS



- Economical design, available with PC terminals or wire leads
- Batteries securely held in place to assure a positive connection and maintain a low contact resistance
- Contact springs self-adjust to variations in battery length
- Withstands shock and vibration
- Available with solder lugs or male/female snap fasteners
- For easy removal, available with ribbon
- Holders for multiple batteries are prewired in series.

SPECIFICATIONS

Holder: Polypropylene

Springs: Spring Steel, Nickel Plate

PC Pins: .031 (.79) Brass, Nickel Plate

Wires (Red & Black): #26 AWG, Tinned, .187 (4.8) end strip UL/CSA1007

MODIFICATIONS

We welcome the opportunity to quote on variations of standard items. Use our Engineering services for your custom-built holders. Holders for "C" and "D" cell are available on request.

PLASTIC BATTERY HOLDERS

"AA"

One (1) Cell

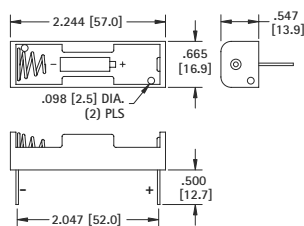

CAT. NO. 2460	PC Mount
CAT. NO. 2460RB	PC Mount w/ribbon
CAT. NO. 2461	Wire Leads - 6.0 (150)

Two (2) Cells - In Series

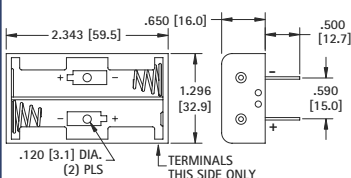

CAT. NO. 2462	PC Mount
CAT. NO. 2462RB	PC Mount w/ribbon
CAT. NO. 2463	Wire Leads - 6.0 (150)

Three (3) Cells - In Series

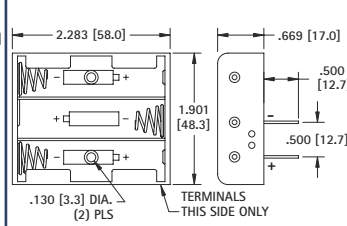

CAT. NO. 2464	PC Mount
CAT. NO. 2464RB	PC Mount w/ribbon
CAT. NO. 2465	Wire Leads - 6.0 (150)

Four (4) Cells - In Series

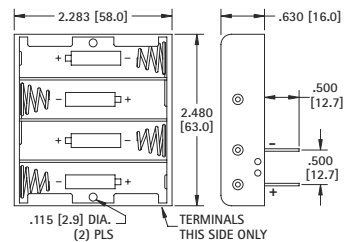

CAT. NO. 2477	PC Mount
CAT. NO. 2477RB	PC Mount w/ribbon
CAT. NO. 2478	Wire Leads - 6.0 (150)

"AAA"

One (1) Cell

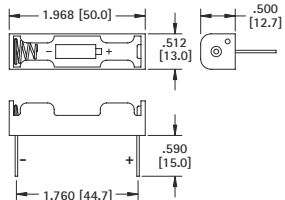

CAT. NO. 2466	PC Mount
CAT. NO. 2466RB	PC Mount w/ribbon
CAT. NO. 2467	Wire Leads - 6.0 (150)

Two (2) Cells - In Series

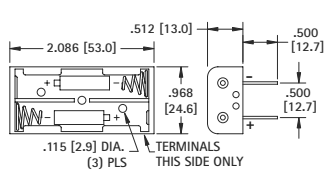

CAT. NO. 2468	PC Mount
CAT. NO. 2468RB	PC Mount w/ribbon
CAT. NO. 2469	Wire Leads - 6.0 (150)

Three (3) "AAA" Cells - In Series

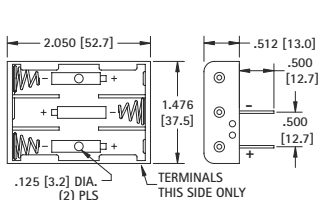

CAT. NO. 2479	PC Mount
CAT. NO. 2479RB	PC Mount w/ribbon
CAT. NO. 2480	Wire Leads - 6.0 (150)

Four (4) Cells - In Series

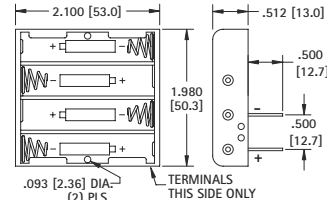

CAT. NO. 2481	PC Mount
CAT. NO. 2481RB	PC Mount w/ribbon
CAT. NO. 2482	Wire Leads - 6.0 (150)

"1/2 AA" • "CR2" • "N" • "12V"

"1/2 AA" Cell - or "CR2" Cell

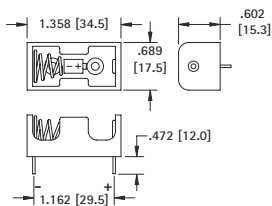

CAT. NO. 2485	PC Mount
CAT. NO. 2485RB	PC Mount w/ribbon
CAT. NO. 2486	Wire Leads - 6.0 (150)

"N" Cell - 1.5V or "12V" Cell

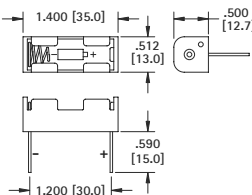

CAT. NO. 2470	PC Mount
CAT. NO. 2470RB	PC Mount w/ribbon
CAT. NO. 2471	Wire Leads - 6.0 (150)

Two (2) "N" or Two (2) "12V" Cells - In Series

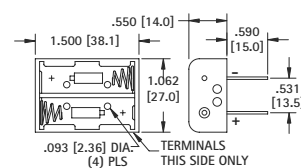

CAT. NO. 2472	PC Mount
CAT. NO. 2472RB	PC Mount w/ribbon
CAT. NO. 2473	Wire Leads - 6.0 (150)

DENSI-PAK® BATTERY HOLDERS

- Supports high density packaging on or off board, positions anywhere for easy access to batteries
- Economical design
- Batteries securely held in place to assure a positive connection and maintain a low contact resistance
- Contact springs self-adjust to variations in battery length
- Snap-on cover protects and secures batteries
- Withstands shock and vibration



SPECIFICATIONS

Holder: ABS

Springs: Spring Steel, Nickel Plate

Wires (Red & Black): 6.0 (150) long, #26 AWG, Tinned, .187 (4.8) end strip UL/CSA1007

"AA"

Two (2) Cells - 3V

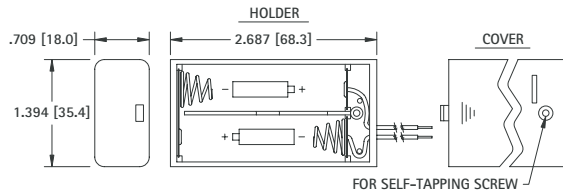

CAT. NO. 2490

Three (3) Cells - 4.5V

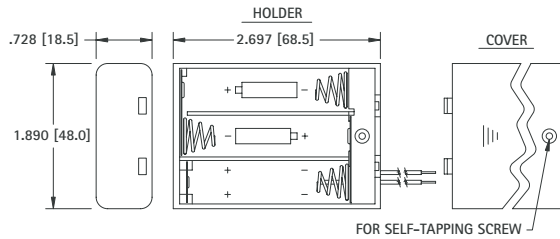

CAT. NO. 2487

"AAA"

Two (2) Cells - 3V

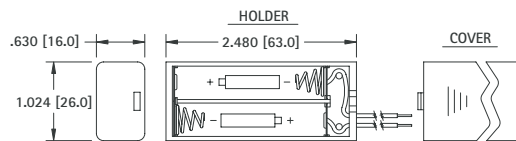

CAT. NO. 2489

Three (3) Cells - 4.5V

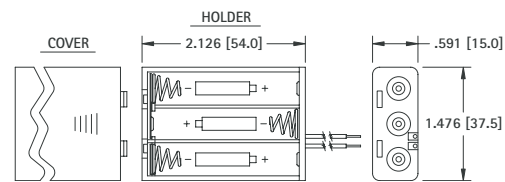

CAT. NO. 2484

PLASTIC BATTERY HOLDERS WITH SNAP-ON CONNECTORS

- Features separable "snap-on/snap-off" battery connector (9 Volt type) to assure reliable connections
- Economical design, holders available for two, three or four cells. Wired in series to accept connector (9 Volt type)
- Easily disconnect battery holder from your device - no tools required
- Batteries securely held in place to maintain a positive contact and a low contact resistance
- Battery contact springs self adjust to variations in battery length
- Withstands shock and vibration
- Ideally mates with Keystone 9 Volt battery straps and connectors (Refer to pages 28 - 29)

"AA"

SPECIFICATIONS

Holder: Polypropylene

Male/Female Contacts: Brass, Nickel Plate

Springs: Spring Steel, Nickel Plate

Two Cells - 3V

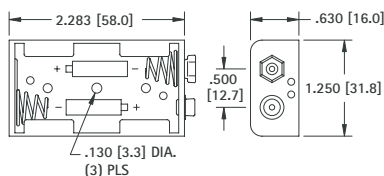

CAT. NO. 2474

Three (3) Cells - 4.5V

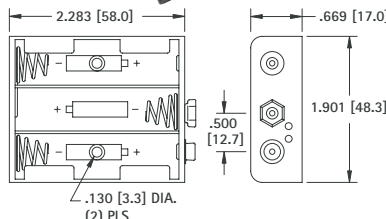

CAT. NO. 2475

Four (4) Cells - 6V

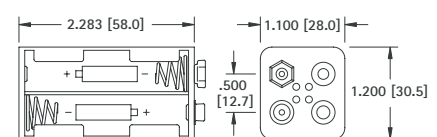

CAT. NO. 2476

SHIELDED 9 VOLT BATTERY STRAPS

- Insulates and shields 9 Volt battery snap-on connector contacts
- Assures safe secure use, reduces the potential of short circuits and prevents tampering with battery contacts
- Protects circuits, prevents unwanted electrical discharge due to unintended grounding
- Protects battery contacts from dust, dirt, and physical damage
- Ideal for rugged applications, made of high impact molded plastic with integral wire lead strain relief

Modifications available with different wire lengths.

SPECIFICATIONS

Base: ABS
 Male/Female Contacts: Brass, Nickel Plate
 Wires (Red & Black): #26 AWG, Tinned, .187 (4.8) end strip, UL/CSA1007

*Tolerance on lead length +/- .250 (6.4)

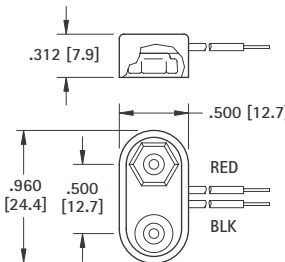
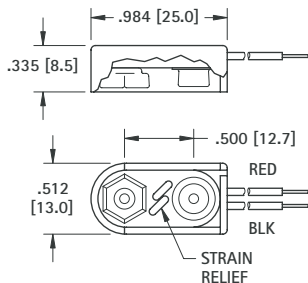

I STYLE		T STYLE	
MOLDED		MOLDED	
CAT. NO.	*LEAD LENGTH	CAT. NO.	*LEAD LENGTH
84-4	4.00 (101.6)	81-4	4.00 (101.6)
84-6	6.00 (152.4)	81-6	6.00 (152.4)
84-8	8.00 (203.2)	81-8	8.00 (203.2)

PREMIUM 9 VOLT BATTERY STRAPS

- Fully Assembled
- Rigid Assembly
- Ideal for rugged applications, made of high impact molded plastic with integral wire lead strain relief

Rigidly constructed. Nickel plate, male and female contacts. Female contacts are spring temper. Accepts numerous insertions to meet U.L. approved standards. Provides excellent mechanical strength and low contact resistance. Wires have tinned copper conductors, PVC insulation and the ends are stripped for easy connection.

Wires are rated to +176°F (+80°C) and 300V and meet UL/CSA #1061/#1007 requirements.

Modifications available with different wire lengths.

SPECIFICATIONS

Contacts: Phosphor Bronze, Nickel Plate
 Wire: #26 AWG, 7/34
 End Strip: .250 (6.4) Long, Tinned
 Base: Polypropylene

*Tolerance on lead length +/- .250 (6.4)



Base Size:
1.062 (27.0) x .512 (13.0)

I STYLE		T STYLE	
MOLDED		MOLDED	
CAT. NO.	*LEAD LENGTH	CAT. NO.	*LEAD LENGTH
2238	4.00 (101.6)	2241	4.00 (101.6)
2239	6.00 (152.4)	2242	6.00 (152.4)
2240	8.00 (203.2)	2243	8.00 (203.2)



Base Size:
1.00 (25.4) x .512 (13.0)

ECONOMY 9 VOLT BATTERY STRAPS

- Fully Assembled
- Rigid Assembly

When product cost is of the utmost importance these economy battery straps will suit your needs. Brass contacts, nickel plated with vinyl or ABS covering. Wires have tinned copper conductors, PVC insulation and the ends are stripped for easy connection. Wires meet UL/CSA #1007 requirements.

Modifications available with different wire lengths

SPECIFICATIONS

Contacts: Brass, Nickel Plate
 Wire: #26 AWG, 7/34
 End Strip: .250 (6.4) Long, Tinned

*Tolerance on lead length +/- .250 (6.4)



Molded ABS Base Size:
.984 (25.0) x .469 (11.9)
(Strain Relief)

I STYLE			T STYLE		
MOLDED		*LEAD LENGTH	MOLDED		VINYL
CAT. NO.	CAT. NO.		CAT. NO.	CAT. NO.	
232-M	232	4.00 (101.6)	235-M	235	
233-M	233	6.00 (152.4)	236-M	236	
234-M	234	8.00 (203.2)	237-M	237	

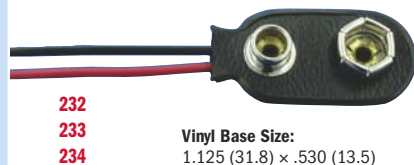

Vinyl Base Size:
1.125 (31.8) x .530 (13.5)



Molded ABS Base Size:
.965 (25.0) x .469 (11.9)
(Strain Relief)

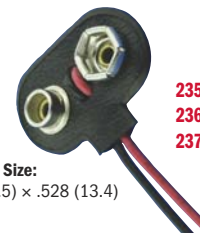

Vinyl Base Size:
1.000 (24.5) x .528 (13.4)

PREMIUM 9 VOLT BATTERY STRAPS

FIBRE BASE

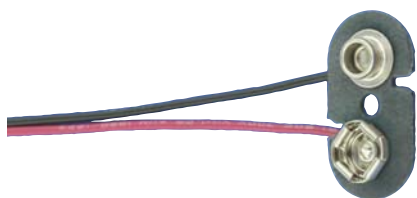

CAT. NO.	*LEAD LENGTH
68	NONE
72-4	4.00 (101.6)
72	7.00 (177.8)
72-8	8.00 (203.2)

Base Size:
1.025 (26.0) x .535 (13.6)
.062 (1.57) thick
Contacts: Steel, Nickel Plate
Wire: #22 AWG, 7/30 Prebond
End Strip: .375 (9.5) Long, Tinned

*Tolerance on lead length +/- .250 (6.4)

FIBRE BASE

- Fully Insulated
- Flexible assembly

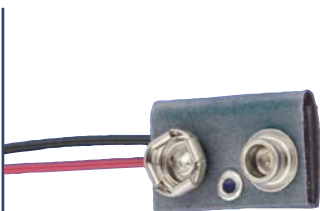

I - STYLE

CAT. NO.	*LEAD LENGTH
83-4	4.00 (101.6)
83	6.50 (165.1)
83-8	8.00 (203.2)

Cover Size:
.900 (22.9) x .575 (14.6)
Contacts: Steel, Nickel Plate
Wire: #22 AWG, 7/30 Prebond
End Strip: .375 (9.5) Long, Tinned

*Tolerance on lead length +/- .250 (6.4)

T - STYLE

CAT. NO.	*LEAD LENGTH
85-4	4.00 (101.6)
85-6	6.50 (165.1)
85-8	8.00 (203.2)

Cover Size:
.900 (22.9) x .575 (14.6)
Contacts: Steel, Nickel Plate
Wire: #22 AWG, 7/30 Prebond
End Strip: .375 (9.5) Long, Tinned

*Tolerance on lead length +/- .250 (6.4)

9 VOLT BATTERY STRAPS & CONTACTS

VERTICAL 9 VOLT PC SNAP-ON CONTACT

- Space saving, economical
- Excellent mechanical strength
- Low contact resistance
- Durable fibre base
- Wave solderable
- Anti-Wicking Design

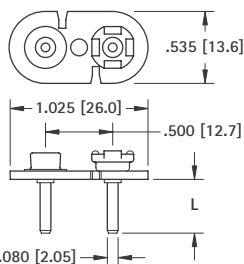

Mounting Detail

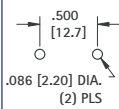

SPECIFICATIONS

Base: .062 (1.57) thick Fibre
Contacts: Steel, Nickel Plate
Pins: Brass, Tin Plate

CAT. NO.	L LENGTH
967 (with PC Pins)	.120 (3.0)
968 (with PC Pins)	.400 (10.2)

9 VOLT SNAP-ON CONTACT

- Cost saving design
- Ideal for custom applications
- Attach your own terminals and wire leads

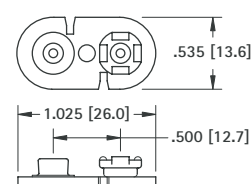

SPECIFICATIONS

Base: .062 (1.57) thick Fibre
Contacts: Steel, Nickel Plate

CAT. NO. 68 (without PC Pins)

DUAL 9 VOLT BATTERY STRAP

This dual battery strap is pre-wired for connecting two 9 Volt batteries. Base made from fibre material with steel, nickel plated contacts. Wires have tinned copper conductors, PVC insulation and the ends are stripped for easy connection. Wires meet UL/CSA #1061 requirements.

SPECIFICATIONS

Contacts: Steel, Nickel Plate
Wire: #22 AWG, 7/30 Prebond
End Strip: .375 (9.5) Long, Tinned

CAT. NO.	*LEAD LENGTH
227	7.00 (177.8)

*Tolerance on lead length +/- .250 (6.4)

PARALLEL

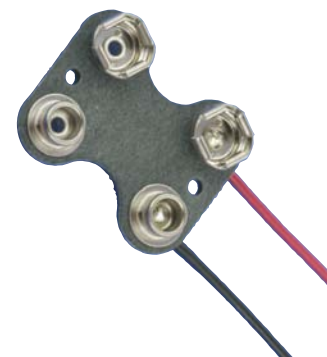
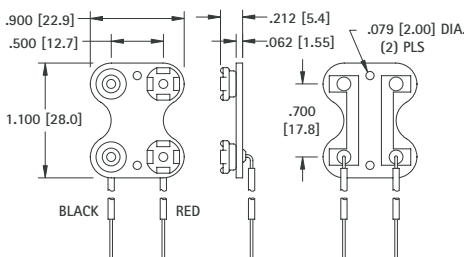

PROTECTIVE BATTERY CAP

- Protects 9 Volt batteries and battery packs when they are not in use
- Snap-fits onto battery contacts
- Both male and female contacts are covered, minimizing physical damage which can occur during battery handling, shipping and storage
- Shields the battery contacts and reduces the potential of a short circuit between battery poles
- Protects sensitive electronic equipment, systems and circuits, cap prevents unwanted electrical discharges
- Protects the battery contacts from damage due to dust, dirt and contamination

MATERIAL:

Impact Resistant Polypropylene, Black

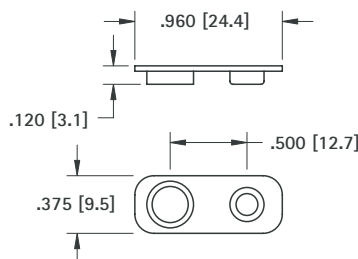

CAT. NO. 96

HORIZONTAL 9 VOLT PC LEAF-SPRING CONTACT

- Ideal "Slide-In" contact for easy installation and removal of 9 Volt batteries
- Space saving design installs directly onto the PC board
- Suitable for .062 (1.57) to .093 (2.36) thick PC boards

- Reliable leaf-spring assures low contact resistance
- Ideal for self-contained battery compartments
- Snap-in mounting legs holds contact secure during wave soldering

MATERIAL: .012 (.30) Spring Steel, Tin-Nickel Plate

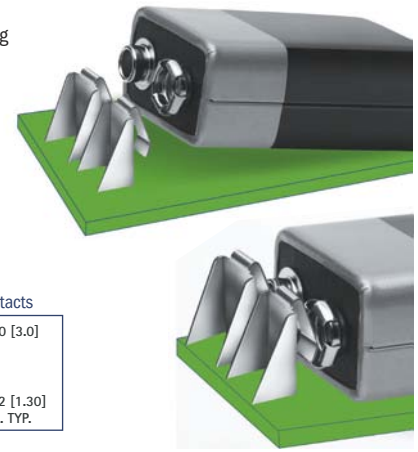
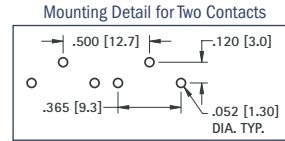
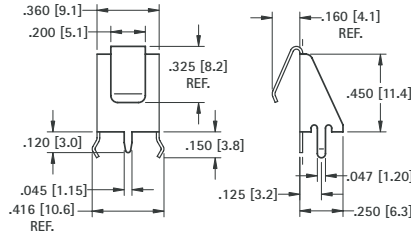

CAT. NO. 590

HORIZONTAL 9 VOLT PC SNAP-ON CONTACTS

Mounts Directly to Printed Circuit Board

- Space saving design installs directly onto the PC board
- Suitable for .062 (1.57) to .093 (2.36) thick PC boards
- Ideal for self-contained battery compartments

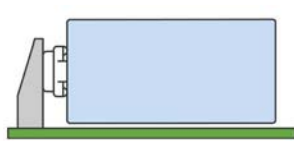

To Mount Battery "On" PC Board
Use Cat. No. 593 and Cat. No. 594

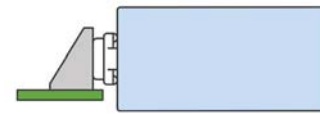

To Mount Battery "Off" PC Board
Use Cat. No. 635 and Cat. No. 636

MATERIAL: Frame: .015 (.38) Steel, Tin Plate; **Contacts:** Steel, Nickel Plate

"Off-Board"

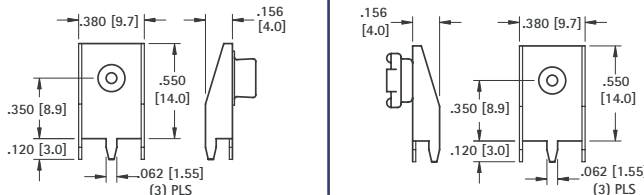

Mounting Detail for Two Contacts

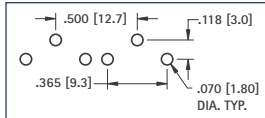

CAT. NO. 593 (Male)

CAT. NO. 594 (Female)

"Off-Board"

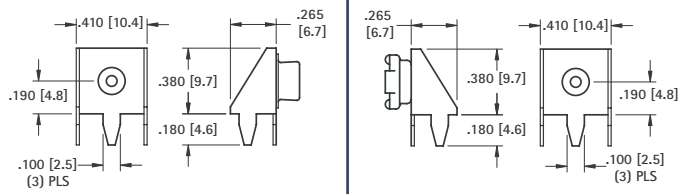

Mounting Detail for Two Contacts

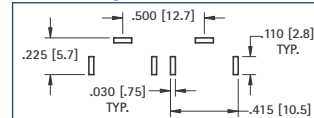

CAT. NO. 635 (Male)

CAT. NO. 636 (Female)

BATTERY SNAP-ONS

For most electronic applications requiring a quick connect and disconnect of circuit. Commonly used with 9 Volt or other batteries designed with snap fasteners. Ideal for temporary or permanent means of connecting without soldering. Can be cascaded together for multiple connections.

SOCKET OR STUD ONLY

FIG. 1

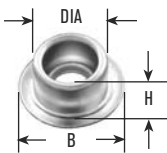

Stud only

FIG. 2

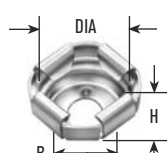

Socket only

CAT. NO.	FIG. NO.	DIA	H	B	HOLE	SIZE	MATERIAL
261*	1	.224 (5.7)	.135 (3.4)	.312 (7.9)	.097 (2.5)	Junior*	Steel, Nickel Plate
269*	2	.210 (5.3)	.150 (3.8)	.250 (6.4)	.096 (2.4)	Junior*	Steel, Nickel Plate
262	1	.283 (7.2)	.143 (3.6)	.423 (10.7)	.125 (3.2)	Senior	Brass, Nickel Plate
270	2	.261 (6.6)	.145 (3.7)	.312 (7.9)	.125 (3.2)	Senior	Brass, Nickel Plate

SOCKET OR STUD W/CRIMP LUG

FIG. 3

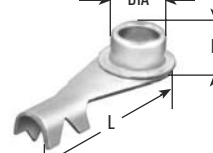

Stud w/Crimp Lug

FIG. 4



Socket w/Crimp Lug

CAT. NO.	FIG. NO.	DIA	H	L	SIZE	MATERIAL
263*	3	.225 (5.7)	.170 (4.3)	.790 (20.1)	Junior	Stud: Steel, Nickel Plate Lug: Brass, Tin Plate
271*	4	.205 (5.2)	.200 (5.1)	.790 (20.1)	Junior	Stud: Steel, Nickel Plate Lug: Brass, Tin Plate
264	3	.283 (7.2)	.185 (4.7)	.840 (21.3)	Senior	Stud: Brass, Nickel Plate Lug: Brass, Tin Plate
272	4	.265 (6.7)	.185 (4.7)	.835 (21.2)	Senior	Stud: Brass, Nickel Plate Lug: Brass, Tin Plate

*Use Jr. Socket and stud for standard 9 Volt Battery

DIMENSIONS ARE FOR REFERENCE ONLY

*Use Jr. Socket and stud for standard 9 Volt Battery

MOLDED 9 VOLT BATTERY HOLDERS

9 VOLT HOLDERS



1294



1295

SPECIFICATIONS

Body: Molded from high impact, Glass Filled Nylon
Terminals: Brass, Tin Plate
Contacts: Steel, Nickel Plate

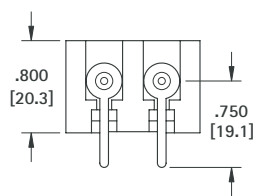
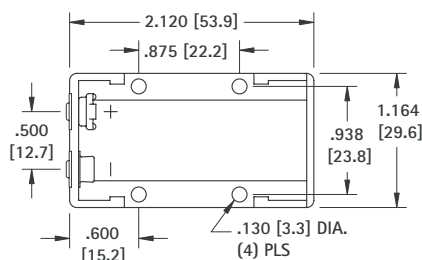

CAT. NO. 1294
PC Terminals

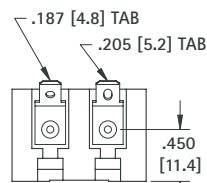

CAT. NO. 1295
Quick-Fit Terminals

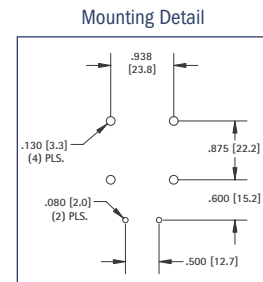

Holds any size, any shape, standard 9 Volt battery. Eliminates need to specify an exact battery brand, size or shape. Ideal for power source or memory back-up use in PLC, telecommunications, data processing, security systems, clocks, radios, toys and appliances.

- Male-female snap-in terminals assure positive contact and proper polarity
- Durable, rugged construction
- Excellent spring retention – holds battery in place
- Withstands severe shock and vibration
- Operating temperature range: -40°F to +266°F (-40°C to +130°C)
- Impervious to most industrial solvents

ALUMINUM 9 VOLT BATTERY HOLDERS

For use with standard 9 Volt battery. Battery snaps in place to insure positive contact. Ideal where severe shock and vibration are encountered. Available with standard solder lugs or printed circuit lugs.

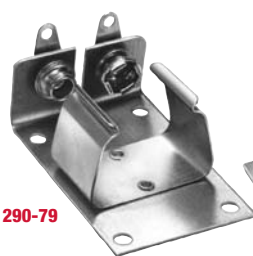

1290-79

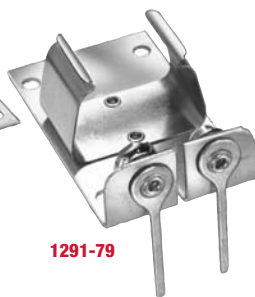

1291-79

SPECIFICATIONS

Frame: Aluminum
Solder Terminals: Brass, Tin Plate
PC Terminals: Brass, Tin Plate
Contacts & Clips: Steel, Nickel Plate
Insulation: Resin Impregnated
Polarizing Washer: Polyethylene

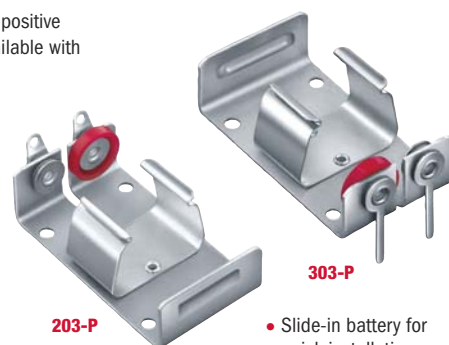

303-P

203-P

- Slide-in battery for quick installation and replacement
- Polarity clearly marked

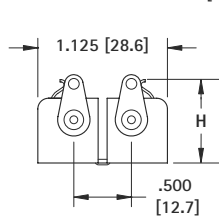
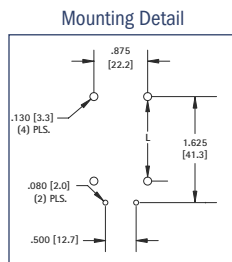
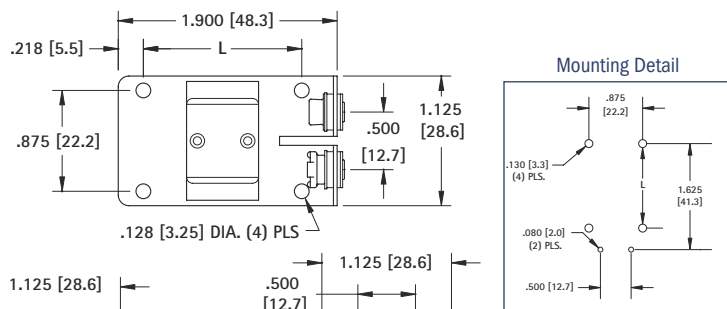

1290

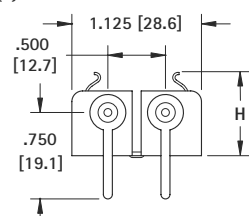

1291

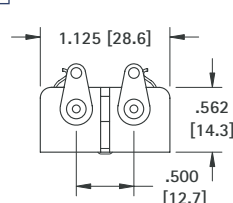
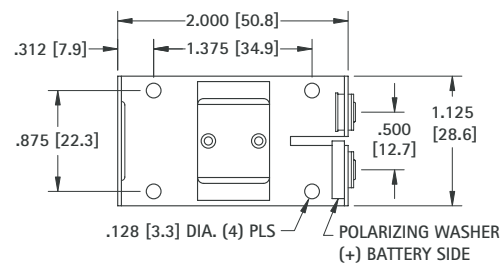

CAT. NO. 203-P
Solder Terminals

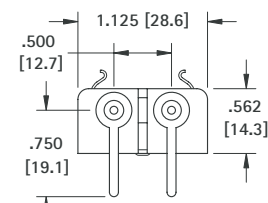

CAT. NO. 303-P
PC Terminals

CAT. NO.	CAT. NO.	H	L	BATTERY REFERENCE	DESCRIPTION
1291	1290	.718 (18.2)	1.375 (34.9)	Alkaline	Low Profile
1291-79	1290-79	.812 (20.6)	1.375 (34.9)	Alkaline	Snap Fit
1291-66	1290-66	.857 (21.8)	1.250 (31.8)	Lithium-Ion	Snap Fit

REFER TO PAGE 8 & 10 FOR PART DIMENSIONS

NOTE: ALL MOUNTING DIMENSIONS ARE FOR REFERENCE ONLY. PLEASE VERIFY YOUR BATTERY LAYOUT PRIOR TO FABRICATION.



50
550

CAT. NO.	"L" DIMENSION	
	For "AAAA"	For "A27"
50	0.33 (8.4) × 1.67 (42.4)	0.300 (7.6) × 10 (28.0)
550	0.89 (22.6)	0.32 (8.1)

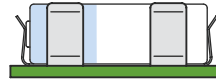

Mounting Detail

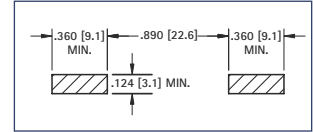

55
555

CAT. NO.	"L" DIMENSION		
	For "AAA"	For "N"	For "A23"
55	0.41 (10.4) × 1.75 (44.5)	0.45 (11.4) × 1.14 (29.0)	0.40 (10.2) × 1.10 (27.9)
555	1.80 (45.7)	1.20 (30.5)	1.15 (29.2)

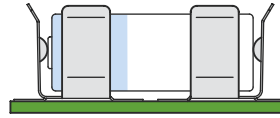

Pad Layout

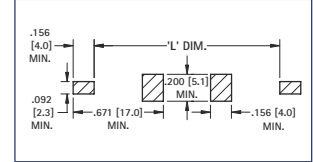

53
553

CAT. NO.	"L" DIMENSION			
	For "AA"	For "2/3 A"	For "CR2"	For "1/2 AA"
53	0.56 (14.2) × 1.98 (50.3)	0.67 (17.0) × 1.36 (34.5)	0.60 (15.2) × 1.05 (26.7)	0.56 (14.2) × 0.97 (24.6)
553	2.05 (52.1)	1.38 (35.1)	1.04 (26.4)	1.04 (26.4)

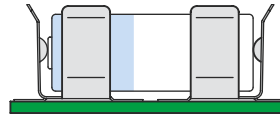

Pad Layout

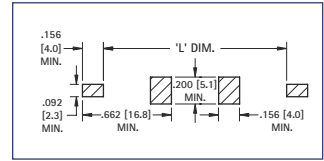

56
556
57
557

CAT. NO.	"L" DIMENSION		
	For "AAA"	For "N"	For "A23"
56	0.41 (10.4) × 1.75 (44.5)	0.45 (11.4) × 1.14 (29.0)	0.4 (10.2) × 1.10 (27.9)
556	1.7 (43.2)	1.1 (27.9)	1.05 (26.7)

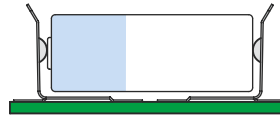

Pad Layout

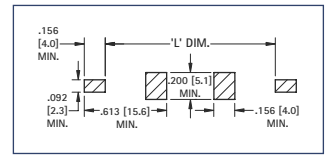

CAT. NO.	"L" DIMENSION			
	For "AA"	For "2/3 A"	For "CR2"	For "1/2 AA"
56	0.56 (14.2) × 1.98 (50.3)	0.67 (17.0) × 1.36 (34.5)	0.60 (15.2) × 1.05 (26.7)	0.56 (14.2) × 0.97 (24.6)
57	1.90 (48.3)	1.23 (31.2)	0.97 (24.6)	0.89 (22.6)



5231
5331
5232
5330

CAT. NO.	"L" DIMENSION			
	For "AA"	For "2/3 A"	For "CR2"	For "1/2 AA"
5231	0.56 (14.2) × 1.98 (50.3)	0.67 (17.0) × 1.36 (34.5)	0.60 (15.2) × 1.05 (26.7)	0.56 (14.2) × 0.97 (24.6)
5331	2.38 (60.5)	1.71 (43.4)	1.53 (24.6)	1.37 (34.8)

CAT. NO.	"L" DIMENSION			
	For "AAA"	For "N"	For "A23"	For "AAAA"
5230	0.41 (10.4) × 1.75 (44.5)	0.45 (11.4) × 1.14 (29.0)	0.40 (10.2) × 1.10 (27.9)	0.33 (8.4) × 1.67 (42.4)
5330	1.96 (49.8)	1.35 (34.3)	1.31 (33.3)	1.86 (47.2)

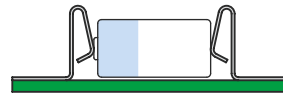

Pad Layout

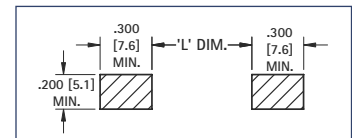

"L" dimensions reflect initial insertion deflection.



206

CAT. NO.	CELL	BATTERY DIM. REFERENCE	"L" DIMENSION
206	For "AA"	0.56 (14.2) × 1.98 (50.3)	1.10 (27.90)
207	For "C"	1.00 (25.4) × 1.97 (50.0)	0.81 (20.60)
208	For "D"	1.30 (33.0) × 2.42 (61.5)	1.25 (31.80)



Pad Layout

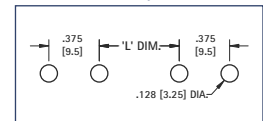

207

REFER TO PAGE 9 FOR PART DIMENSIONS

NOTE: ALL MOUNTING DIMENSIONS ARE FOR REFERENCE ONLY. VERIFY YOUR BATTERY LAYOUT PRIOR TO FABRICATION.

Mounting Detail

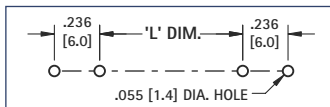

CAT. NO.	"L" DIMENSION	
	For "AAAA"	For "A27"
51	0.33 (8.4) × 1.67 (42.4)	0.300 (7.6) × 1.10 (28.0)
	1.07 (27.2)	0.50 (12.7)



51

Mounting Detail

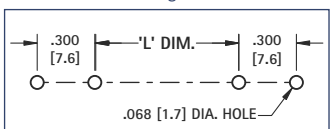

CAT. NO.	"L" DIMENSION		
	For "AAA"	For "N"	For "A23"
82	0.41 (10.4) × 1.75 (44.5)	0.45 (11.4) × 1.14 (29.0)	0.40 (10.2) × 1.10 (27.9)
	1.08 (27.4)	0.47 (11.9)	0.43 (10.9)

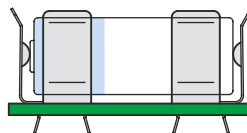

82
92
2915



52

CAT. NO.	"L" DIMENSION			
	For "AA"	For "2/3 A"	For "CR2"	For "1/2 AA"
52	0.56 (14.2) × 1.98 (50.3)	0.67 (17.0) × 1.36 (34.5)	0.60 (15.2) × 1.05 (26.7)	0.56 (14.2) × 0.97 (24.6)
92	1.32 (33.5)	0.67 (17.0)	0.39 (9.9)	0.31 (7.9)
2915	1.32 (33.5)	-	N/A	0.31 (7.9)
		-	N/A	0.31 (7.9)

Mounting Detail

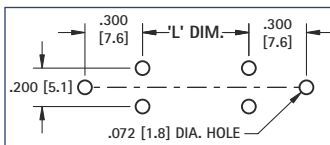

CAT. NO.	"L" DIMENSION	
	For "18650"	For "2/3 A"
54	0.71 (18.4) × 2.56 (65.0)	0.67 (17.0) × 1.36 (34.5)
	1.85 (47.0)	0.57 (14.5)

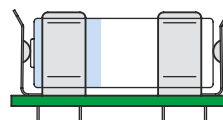

54

Mounting Detail

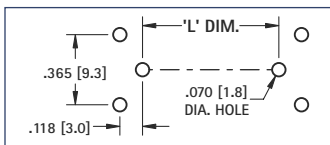

CAT. NO.	"L" DIMENSION	
	For "2/3 A"	For "CR2"
595 with 628	0.67 (17.0) × 1.36 (34.5)	0.60 (15.2) × 1.05 (26.7)
	1.46 (37.1)	1.18 (30.0)



628

595

Mounting Detail

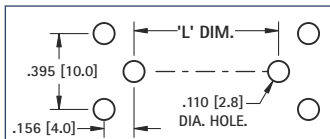

CAT. NO.	"L" DIMENSION				
	For "AA"	For "AAA"	For "1/2AA"	For "N"	For "A23"
637 with 629	0.56 (14.2) × 1.98 (50.3)	0.41 (10.4) × 1.75 (44.5)	0.56 (14.2) × 0.97 (24.6)	0.45 (11.4) × 1.14 (29.0)	0.40 (10.2) × 1.10 (27.9)
	2.11 (53.9)	1.88 (47.8)	1.10 (27.9)	1.27 (32.3)	1.23 (31.2)

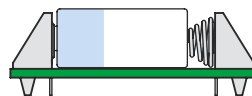

637



629

Mounting Detail

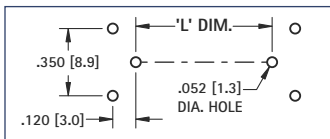

CAT. NO.	"L" DIMENSION			
	For "AA"	For "2/3 A"	For "CR2"	For "1/2 AA"
596 with 590	0.56 (14.2) × 1.98 (50.3)	0.67 (17.0) × 1.36 (34.5)	0.60 (15.2) × 1.05 (26.7)	0.56 (14.2) × 0.97 (24.6)
590 with 590	2.07 (52.6)	N/A	1.14 (29.0)	1.06 (26.9)
	2.15 (54.6)	1.50 (38.1)	1.22 (31.0)	1.14 (29.0)



596
597



590
591

CAT. NO.	"L" DIMENSION		
	For "AAA"	For "N"	For "A23"
597 with 591	0.41 (10.4) × 1.75 (44.5)	0.45 (11.4) × 1.14 (29.0)	0.40 (10.2) × 1.10 (27.9)
591 with 591	1.83 (46.5)	1.22 (31.0)	1.18 (30.0)
	1.91 (48.5)	1.30 (33.0)	1.26 (32.0)

"L" dimensions reflect initial insertion deflection.

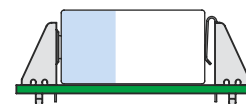

REFER TO PAGES 12 & 13 FOR PART DIMENSIONS

NOTE: ALL MOUNTING DIMENSIONS ARE FOR REFERENCE ONLY. PLEASE VERIFY YOUR BATTERY LAYOUT PRIOR TO FABRICATION.

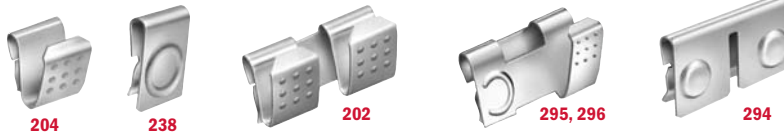

CAT. NO.	FIG. NO.	"L" DIMENSION			
		For "AAA" 0.41 (10.4) × 1.75 (44.5)	For "N" 0.45 (11.4) × 1.14 (29.0)	For "12 V" 0.40 (10.2) × 1.10 (27.9)	For "AAAA" 0.33 (8.4) × 1.67 (42.4)
204 with 238	1	1.87 (47.5)	1.26 (32.0)	1.22 (31.0)	1.79 (45.5)
204,238 with 295, 296	1	1.87 (47.5)	1.26 (32.0)	1.22 (31.0)	1.79 (45.5)
202 with 294	1	1.87 (47.5)	1.26 (32.0)	1.22 (31.0)	1.79 (45.5)
204 with 204	2	1.97 (50.0)	1.36 (34.5)	1.32 (33.5)	1.89 (48.0)
204 with 202	2	1.97 (50.0)	1.36 (34.5)	1.32 (33.5)	1.89 (48.0)

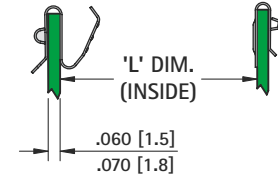

Fig. 1 Spring-Button

"L" dimensions reflect initial insertion deflection.



CAT. NO.	FIG. NO.	"L" DIMENSION			
		For "AA" 0.56 (14.2) × 1.98 (50.3)	For "1/2 AA" 0.56 (14.2) × 0.97 (24.6)	For "CR2" 0.60 (15.2) × 1.05 (26.7)	For "2/3 A" 0.67 (17.0) × 1.36 (34.5)
209 with 228	1	2.13 (54.1)	1.12 (28.4)	1.29 (32.8)	1.46 (37.1)
209, 228 with 290, 291	1	2.13 (54.1)	1.12 (28.4)	N/A	N/A
288, 210 with 292	1	2.13 (54.1)	1.12 (28.4)	N/A	N/A
209 with 209	2	2.27 (57.7)	1.26 (32.0)	1.34 (34.0)	1.60 (40.6)
209 with 288, 210	2	2.27 (57.7)	1.26 (32.0)	N/A	N/A

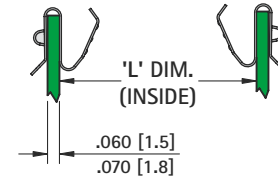
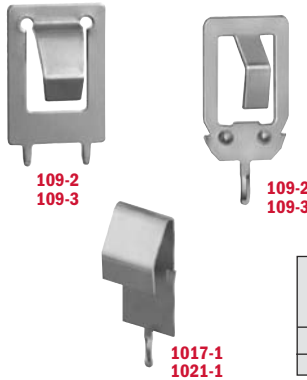

Fig. 2 Spring-Spring

"L" dimensions reflect initial insertion deflection.



CAT. NO.	"L" DIMENSION			
	For "AA" 0.56 (14.2) × 1.98 (50.3)	For "1/2 AA" 0.56 (14.2) × 0.97 (24.6)	For "CR2" 0.60 (15.2) × 1.05 (26.7)	For "2/3 A" 0.67 (17.0) × 1.36 (34.5)
109-2	2.22 (56.4)	1.21 (30.7)	1.29 (32.8)	1.55 (39.4)
109-3	2.22 (56.4)	1.21 (30.7)	1.29 (32.8)	1.55 (39.4)
1017-1	2.19 (55.6)	1.18 (29.9)	1.26 (32.0)	1.52 (38.6)
108-2	2.22 (56.4)	1.21 (30.7)	1.29 (32.8)	1.55 (39.4)

CAT. NO.	"L" DIMENSION			
	For "AAA" 0.41 (10.4) × 1.75 (44.5)	For "N" 0.45 (11.4) × 1.14 (29.0)	For "12 V" 0.40 (10.2) × 1.10 (27.9)	For "AAAA" 0.33 (8.4) × 1.67 (42.4)
1021-1	1.96 (49.8)	1.35 (34.3)	1.31 (33.3)	1.88 (47.8)
108-2	1.99 (50.5)	1.38 (35.0)	1.34 (34.0)	1.91 (48.5)

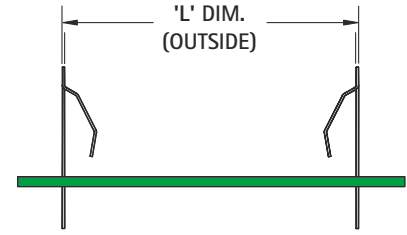

"L" dimensions reflect initial insertion deflection.

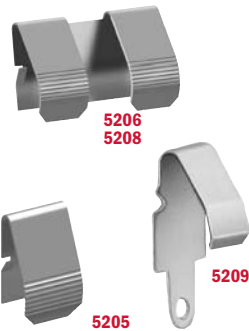

CAT. NO.	"L" DIMENSION			
	For "AA" 0.56 (14.2) × 1.98 (50.3)	For "1/2 AA" 0.56 (14.2) × 0.97 (24.6)	For "CR2" 0.60 (15.2) × 1.05 (26.7)	For "2/3 A" 0.67 (17.0) × 1.36 (34.5)
5205	2.28 (57.9)	1.27 (32.3)	1.35 (34.3)	1.61 (40.8)
5205 with 5206	2.28 (57.9)	1.27 (32.3)	N/A	N/A
5209	2.34 (59.4)	1.33 (33.8)	1.41 (35.87)	1.67 (42.4)
5209 with 5208	2.34 (59.4)	1.33 (33.8)	N/A	N/A

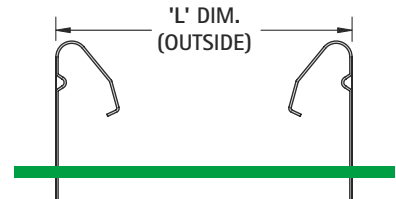

"L" dimensions reflect initial insertion deflection.



CAT. NO.	"L" DIMENSION			
	For "AAA" 0.41 (10.4) × 1.75 (44.5)	For "N" 0.45 (11.4) × 1.14 (29.0)	For "12 V" 0.40 (10.2) × 1.10 (27.9)	For "AAAA" 0.33 (8.4) × 1.67 (42.4)
230-1	1.73 (43.9)	1.12 (29.0)	1.08 (27.9)	1.65 (42.4)

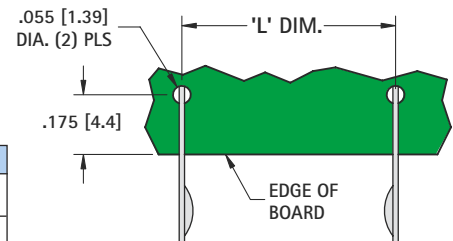

REFER TO PAGE 14 THRU 16 FOR PART DIMENSIONS

NOTE: ALL MOUNTING DIMENSIONS ARE FOR REFERENCE ONLY. VERIFY YOUR BATTERY LAYOUT PRIOR TO FABRICATION.

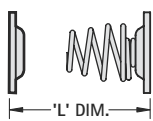

Fig. 1

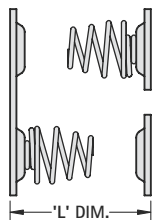

Fig. 2

CAT. NO.	"L" DIMENSION				
	FIG. NO.	For "AAA"	For "N"	For "12V"	For "AAAA"
5203 with 5225	1	0.41 (10.4) × 1.75 (44.5)	0.45 (11.4) × 1.14 (29.0)	0.40 (10.2) × 1.10 (27.9)	0.33 (8.4) × 1.67 (42.4)
5204 with 5226	1	1.95 (49.5)	1.34 (34.0)	1.30 (33.0)	1.87 (47.5)
5214, 5213 with 5203, 5225	2	1.95 (49.5)	1.34 (34.0)	1.30 (33.0)	1.87 (47.5)

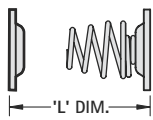

Fig. 1

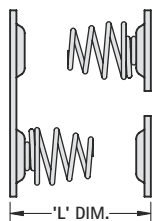

Fig. 2

CAT. NO.	"L" DIMENSION			
	FIG. NO.	For "AA"	For "1/2 AA"	For "2/3 A"
5202 with 5224	1	0.56(14.2) × 1.98(50.3)	0.56(14.2) × 0.97(24.6)	0.67 (17.0) × 1.36(34.5)
5222 with 5221	1	2.24 (56.9)	1.23 (31.2)	1.62 (41.1)
5201 with 5223	1	2.24 (56.9)	1.23 (31.2)	1.62 (41.1)
5220 with 5219	1	2.24 (56.9)	1.23 (31.2)	1.62 (41.1)
5201, 5223 with 5210, 5211	2	2.24 (56.9)	1.23 (31.2)	N/A
5222, 5221 with 5212	2	2.24 (56.9)	1.23 (31.2)	N/A
5220, 5219 with 5217, 5218	2	2.24 (56.9)	1.23 (31.2)	N/A
5227 with 5228	2	2.24 (56.9)	1.23 (31.2)	N/A

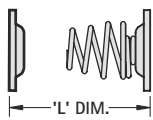

Fig. 1

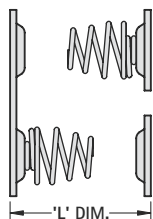
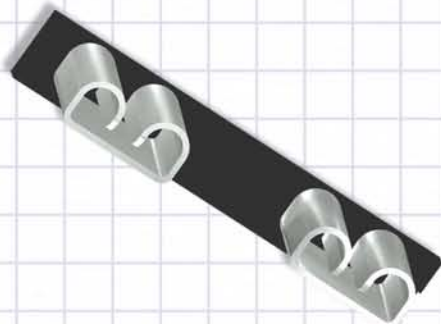
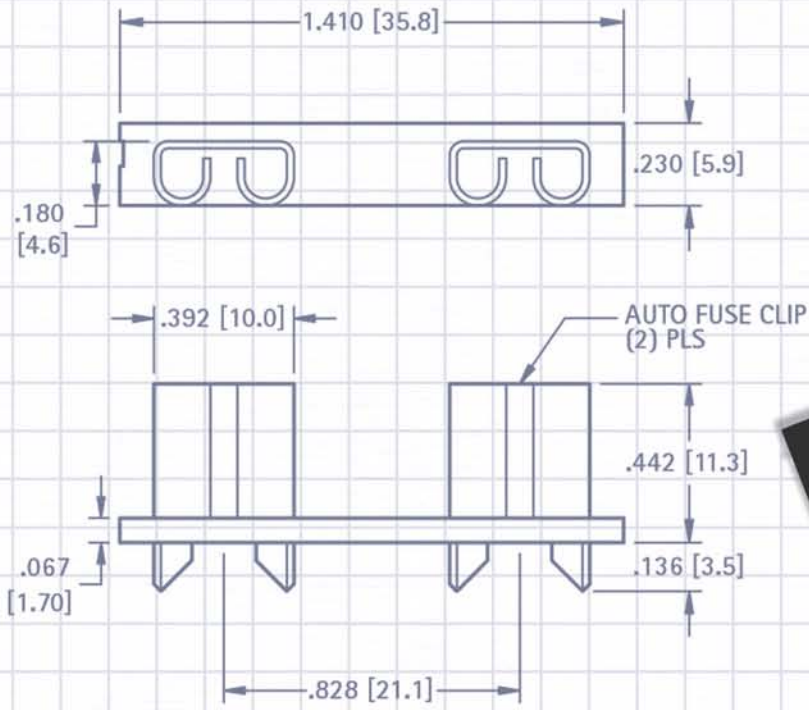
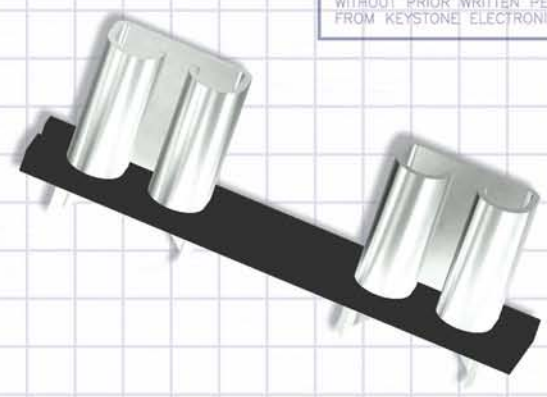

Fig. 2

CAT. NO.	"L" DIMENSION		
	FIG. NO.	For "C"	For "D"
5240 with 5241	1	0.99(25.0) × 1.97(50.0)	1.30(33.0) × 2.24(56.9)
5250 with 5251	1	N/A	2.75 (69.9)
5240, 5241 with 5242	2	2.25 (57.2)	N/A
5250, 5251 with 5252, 5253	2	N/A	2.75 (69.9)

THIS DOCUMENT IS THE PROPERTY OF KEYSTONE ELECTRONICS CORP. AND SHALL NOT BE REPRODUCED, DISTRIBUTED OR USED AS A BASIS FOR MANUFACTURE WITHOUT PRIOR WRITTEN PERMISSION FROM KEYSTONE ELECTRONICS CORP.



FUSE CLIPS & HOLDERS

Our comprehensive line of fuse clips, contacts and holders are ideally suited for use in today's industrial, electronic and automotive devices. Applications include:

- Delicate microcircuitry
- Consumer Electronics
- Telecom and Datacom devices
- Mini, Standard & Maxi blade Automotive Fuses
- High Shock and Vibration applications
- High Amperage applications
- UL approved devices

Our quality system is ISO 9001:2008 certified. Our products are in compliance with the RoHS and REACH directives. We provide 3D modeling, CAD and other application-engineering support for modifications, special designs or assembly requirements to assist you in choosing the right Keystone product for your application.

DATE	DESCRIPTION	REV.

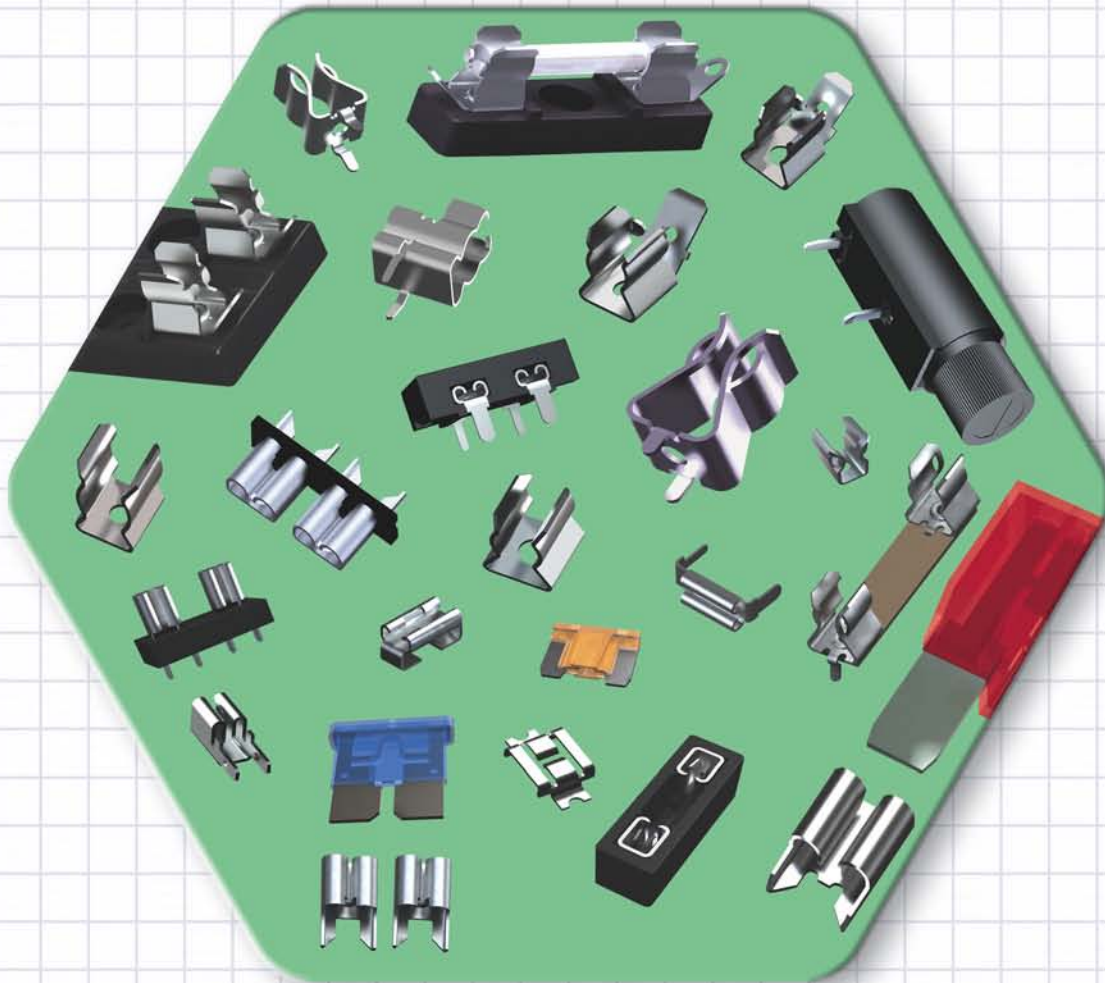

SECTION CONTENTS

AUTOMOTIVE FUSE CLIPS

Low Profile.....	39-41
Maxi	38
Mini	40-41
Standard	39, 41

AUTOMOTIVE FUSE HOLDERS

Low Profile.....	39-41
Maxi	38
Mini	40-41
Standard.....	38-39, 41
Cylindrical Fuse Covers	43

CYLINDRICAL FUSE CLIPS

5mm	44
2AG thru 8AG	44-45
5AG, Midget, SPF	44

CYLINDRICAL FUSE HOLDERS

5mm	42
3AG	42-43
Midget, SPF, 5AG Fuse Holder	43

SUBMINIATURE FUSE HOLDERS

Cylindrical, Rectangle	43
------------------------------	----

MOUNTING DETAILS 46-49

AUTOMOTIVE BLADE FUSE CLIP & HOLDERS

- Available for standard, mini and maxi fuse sizes
- Horizontal and vertical mini blade clips and holders for Littelfuse Low Profile Mini 897 series, Mini 297 or 997 series, Bussmann ATM series fuses or equivalents

- Horizontal and vertical standard blade clips and holders for Littelfuse ATO 257 series and Bussmann ATC series fuses or equivalents
- Vertical maxi blade clips and holders for Littelfuse Maxi 297 series and Bussmann MAX series fuses or equivalent.

- Thru hole PC mountable, maintains position during wave soldering
- Holds fuse securely, even after multiple insertions
- Available with orientation legs to assure proper orientation

“MAXI” AUTOMOTIVE FUSE CLIP & HOLDER

FOR .312 (7.9) × .032 (.80) MAXI BLADE FUSES

For Littelfuse Maxi 297 series/Bussmann Max series or equivalent

- Thru hole PC mountable, maintains position during wave soldering
- Holder design prevents solder wicking
- Withstands the rigors of shock and vibration
- Holds fuse securely, even after multiple insertions

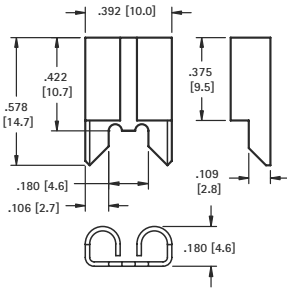

SPECIFICATIONS

Contacts: .020 (.51) Copper, Tin-Nickel Plate
Insulator: Glass filled Nylon, UL Rated 94V-0
Current Rating: 40 Amps @ 500V AC
Temperature Rating: -58°F to +292°F (-50°C to +145°C)

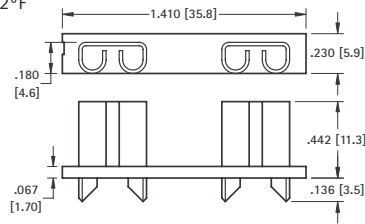

Mounting Detail For Two Clips

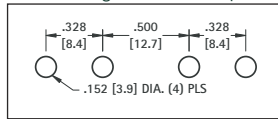

CAT. NO. 3555

CAT. NO. 3555-2

MODULAR AUTOMOTIVE BLADE FUSE HOLDERS

FOR .205 (5.2) × .025 (.64) STANDARD BLADE FUSES

For Littelfuse ATO 257 series/Bussmann ATC series or equivalent

SPECIFICATIONS

Contacts: Brass, Tin Plate
Body: Nylon
Current Rating: 30 Amps @ 500V AC
Temperature Rating: -58°F to +292°F (-50°C to +145°C)

- Designed for standard auto blade fuses
- Fully insulated compact design
- Mounts easily in pre-drilled or punched hole
- Holder has pocket to hold spare fuse
- Safety lever release clip will not open under shock or vibration
- Fuses are installed and removed easily
- May be used individually or easily interlocked for multiple mounting



3560 (Shown with two 3560 holders, interlocked)



3559 (14 gauge wire lead must be cut and spliced for in-line use)

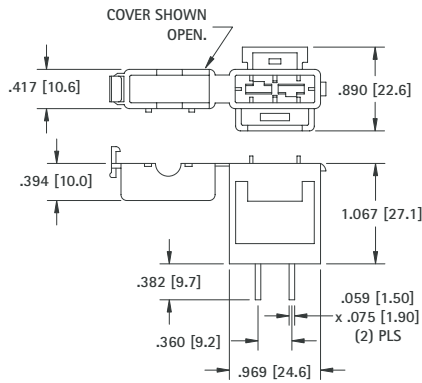

COVER SHOWN OPEN.

Mounting Detail For Two Holders

Mounting Detail

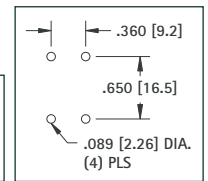
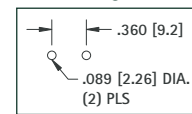

CAT. NO. 3560 (PC Mount)

CAT. NO. 3559 (In Line)

SPECIFICATIONS

Contacts: Brass, Tin Plate
Body: Nylon
Current Rating: 30 Amps @ 500V AC
Temperature Rating: -58°F to +292°F (-50°C to +145°C)

- Fully insulated fuse mount
- Designed for standard auto blade fuses
- Mounts easily in punched hole
- Fuses are installed and removed easily
- May be used individually or easily interlocked for multiple mounting



CAT. NO. 3558

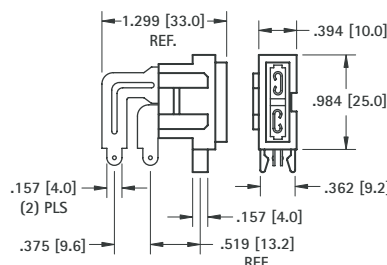

Mounting Detail

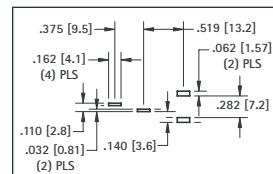

Mounting Detail For Two Holders

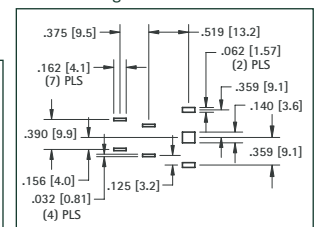

“AUTO” FUSE CLIPS & HOLDERS

STANDARD AUTOMOTIVE BLADE FUSE CLIPS & HOLDERS

FOR .205 (5.2) × .025 (.64) STANDARD BLADE FUSES

For Littelfuse ATO 257 series/Bussmann ATC series or equivalent

- Holds fuse securely, even after multiple insertions
- Thru hole-mount, maintains position during wave soldering
- Withstands the rigors of shock and vibration
- Holder design prevents solder wicking

VERTICAL FUSE ENTRY

SPECIFICATIONS

Contacts: .016 (.41) Brass, Tin-Nickel Plate
Insulator: Glass filled Nylon, UL Rated 94V-0
Current Rating: 30 Amps @ 500V AC
Temperature Rating: -58°F to +292°F (-50°C to +145°C)

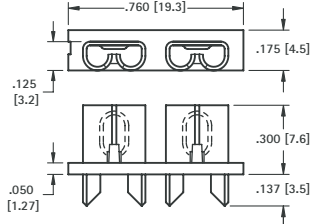

Mounting Detail For Two Clips

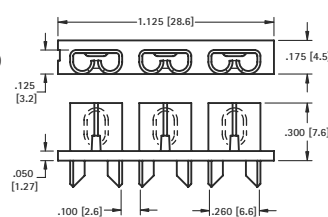
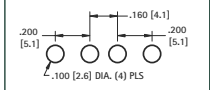

Mounting Detail For Two Clips

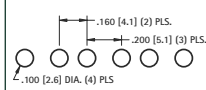

3522-2

3522-3

CAT. NO. 3522-2

CAT. NO. 3522-3

VERTICAL ENTRY

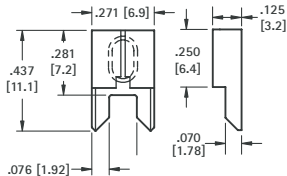

SPECIFICATIONS

Contacts: .016 (.41) Brass
Current Rating: 20 Amps @ 500 VAC

Mounting Detail For Two Clips

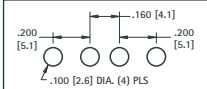

LOW INSERTION FORCE

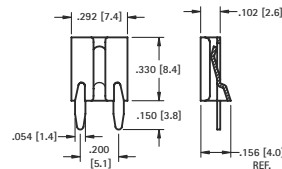

CAT. NO. 3522 Tin-Nickel Plate

CAT. NO. 3573 Matte Tin Plate

2 IN 1 FUSE HOLDER

For Littelfuse ATO 257 series/Bussmann ATC series, Littelfuse Low Profile Mini 897 series or equivalents

- Low insertion force
- Fuse holder fully insulates clips to protect fuse from shorting
- Holder assures proper spacing and reduces assembly time
- Thru hole PC mountable, maintains position during wave soldering

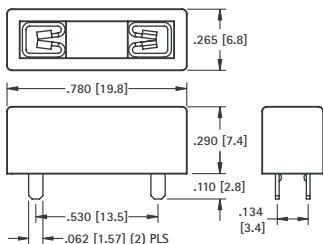

Mounting Detail

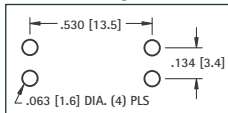

UNIVERSAL CLIP

For Littelfuse ATO 257 series/Bussmann ATC series, Littelfuse Mini 297 or 997 series/Bussmann ATM series, Littelfuse Low Profile Mini 897 series or equivalents

- Accepts most Auto-Blade Fuses
- Low insertion force
- Thru hole PC mountable, maintains position during wave soldering

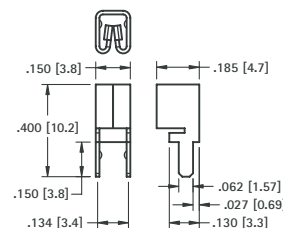

Mounting Detail

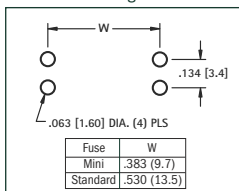

CAT. NO. 3557-2

CAT. NO. 3557 - Top Entry

CAT. NO. 3577 - Bottom Entry

HORIZONTAL FUSE ENTRY

- Designed for low height clearance applications
- Fuse will be inserted parallel to board
- Thru hole mount, maintains position during wave soldering
- Fuse holder fully insulates clips to protect fuse from shorting
- Holder assures proper spacing and reduces assembly time
- Polarized legs assure proper orientation of clips onto board

SPECIFICATIONS

Contacts: .012 (.30) Brass, Nickel Plate
Insulator: Nylon, UL Rated 94V-0
Current Rating: 15 Amps @ 500V AC
Temperature Rating: -58°F to +292°F (-50°C to +145°C)

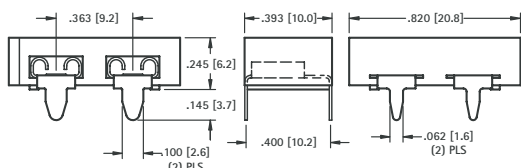

Mounting Detail For Two Clips

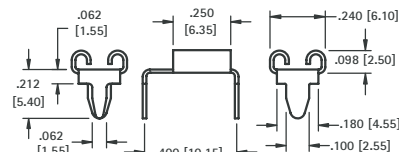
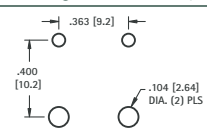

CAT. NO. 3550-2

CAT. NO. 3550

"MINI" AUTOMOTIVE FUSE CLIPS & HOLDERS

For .110 (2.8) x .032 (.80) MINI BLADE FUSES

For Littelfuse Mini 297 or 997 series/Bussmann ATM series or equivalent

VERTICAL FUSE ENTRY

Thru Hole Mount



- Low Profile

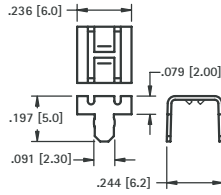

Mounting Detail For Two Clips

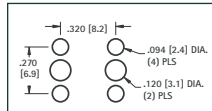

Pad Layout For Two Clips

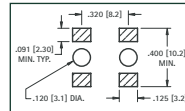

AVAILABLE ON TAPE AND REEL

Surface Mount



- Low Profile

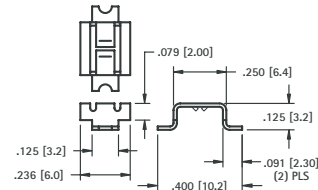

CAT. NO. 3563 (Bulk)

CAT. NO. 3563TR (Tape & Reel)

Tape & Reel Spec's: 24mm wide; 12mm pitch; 13 inch reel (1500 pieces per reel)

CAT. NO. 3564

SPECIFICATIONS

Material: .012 (.30) Brass

Insulator: Glass filled Nylon, UL Rated 94V-0

Current Rating: 15 Amps @ 500V AC

Temperature Rating: -58°F to +292°F (-50°C to +145°C)

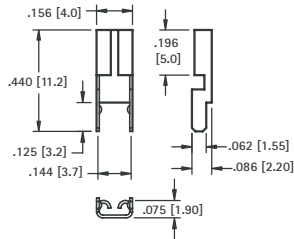

Mounting Detail For Two Clips

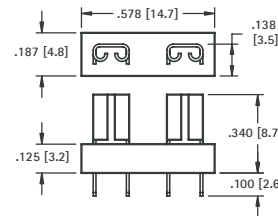
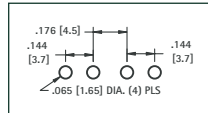

CAT. NO. 3544 Tin-Nickel Plate

CAT. NO. 3544-2 Tin Plate

LOW PROFILE MINI FUSE HOLDER

For Littelfuse Low Profile Mini 897 series or equivalent

- Low insertion force
- Thru hole PC mountable, maintains position during wave soldering
- Fuse holder fully insulates clips to protect fuse from shorting
- Holder assures proper spacing and reduces assembly time

SPECIFICATIONS

Contacts: .016 (.41) Brass, Tin-Nickel Plate

Insulator: Nylon 4/6, UL Rated 94V-0

Current Rating: 20 Amps @ 500V AC

Temperature Rating: -58°F to +292°F (-50°C to +145°C)

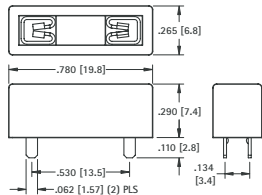

Mounting Detail

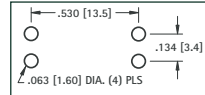

Refer to page 39 for Cat. No. 3557 Clip details

Mounting Detail

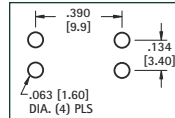

MINI FUSE HOLDER

For Littelfuse Mini 297 or 997 series/Bussmann ATM or equivalents

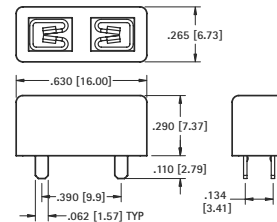

CAT. NO. 3557-2

CAT. NO. 3568

HORIZONTAL FUSE ENTRY

For Littelfuse Mini 297 or 997 series/Bussmann ATM series or equivalent

SPECIFICATIONS

Contacts: .012 (.30) Brass

Insulator: Nylon 6/6, UL Rated 94V-0

Current Rating: 15 Amps @ 500V AC

Temperature Rating: -58°F to +292°F (-50°C to +145°C)

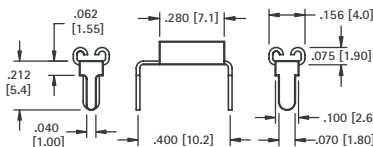

Mounting Detail For Two Clips

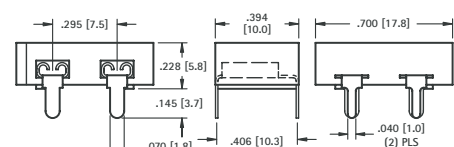
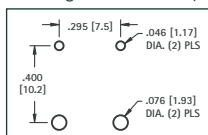

CAT. NO. 3549 Nickel Plate

CAT. NO. 3549-2 Tin Plate

"AUTO" FUSE CLIPS & HOLDERS

SMT "AUTO" BLADE FUSE HOLDERS

- Compatible with most vacuum and mechanical pick and place assembly systems.
- Fully insulated clips to protect fuses against shorting.
- One piece assembly reduces assembly time
- Withstands shock and vibration.

2 in 1 FUSE HOLDER

For Standard: Littelfuse: ATO series/
Bussmann ATC series.
For Low Profile: Littelfuse: 891 series/
Bussmann ATM-LP series

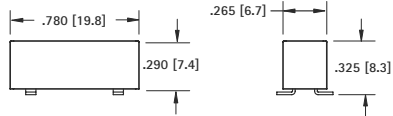
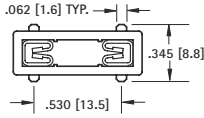

Mounting Detail

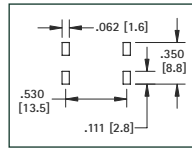

MINI FUSE HOLDER

For Mini: Littelfuse: MIN series/
Bussmann ATM series or equivalent

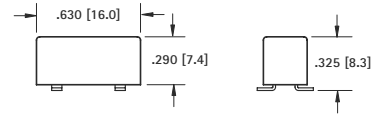
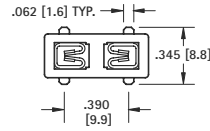

Mounting Detail

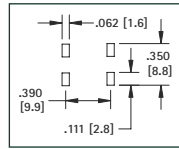

SPECIFICATIONS

Contacts: .016 (.41) Brass, Matte Tin Plate
Insulator: High Temperature Nylon 46, UL 94V-0
Temperature Rating: -58°F to +292°F (-50°C to +145°C)
Current Rating: 20 Amps @ 500V AC

CAT. NO. 3587 (Bulk)

SPECIFICATIONS

Contacts: .016 (.41) Brass, Matte Tin Plate
Insulator: High Temperature Nylon 46, UL 94V-0
Temperature Rating: -58°F to +292°F (-50°C to +145°C)
Current Rating: 20 Amps @ 500V AC

CAT. NO. 3587TR (Tape & Reel)

Tape & Reel Spec's: 32mm wide, 16mm pitch, 13 inch reel (500 pieces per reel)

Tape & Reel Spec's: 32mm wide, 16mm pitch, 13 inch reel (500 pieces per reel)

SMT "AUTO" BLADE FUSE CLIPS

- Compatible with most vacuum and mechanical pick and place assembly systems.
- Accepts standard and mini blade automotive blade fuses.
- Clip with Matte-Tin plate is ideal for low temperature soldering applications, for other temperature sensitive components.
- Clips with Tin-Nickel plate are ideal for lead free, high temperature soldering applications.

VERTICAL ENTRY

For Mini: Littelfuse: MIN series/Bussmann ATM series.
For Standard: Littelfuse: ATO series/Bussmann ATC series.
For Low Profile: Littelfuse: 891 series/Bussmann ATM-LP series

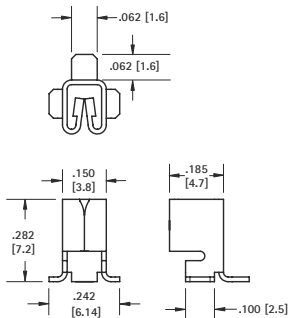

Pad Layout For Two Clips

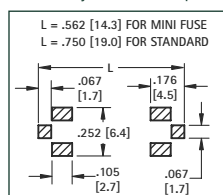

SPECIFICATIONS

Material: .016 (.41) Brass, Tin-Nickel Plate
Current Rating: 20 Amps @ 500V AC

CAT. NO. 3586 (Bulk)

CAT. NO. 3586TR (Tape & Reel)

Tape & Reel Spec's: 16mm wide, 12mm pitch, 13 inch reel (750 pieces per reel)

VERTICAL ENTRY

For Mini: Littelfuse: MIN series/Bussmann ATM series or equivalent

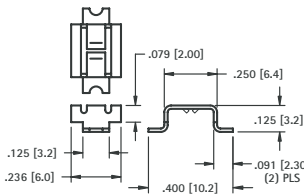

Pad Layout For Two Clips

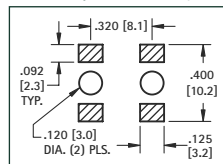

SPECIFICATIONS

Material: .016 (.41) Brass, Matte Tin Plate
Current Rating: 15 Amps @ 500V AC

CAT. NO. 3563 (Bulk)

CAT. NO. 3563TR (Tape & Reel)

Tape & Reel Spec's: 24mm wide, 12mm pitch, 13 inch reel (1500 pieces per reel)

HORIZONTAL ENTRY

For Mini: Littelfuse: MIN series/Bussmann ATM series or equivalent

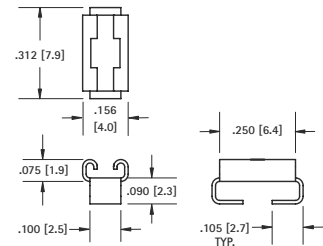
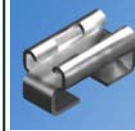

Mounting Detail For Two Clips

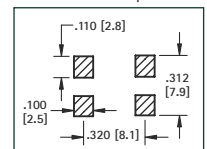

SPECIFICATIONS

Material: .012 (.30) Brass, Tin-Nickel Plate
Current Rating: 15 Amps @ 500V AC

CAT. NO. 3569 (Bulk)

CAT. NO. 3569TR (Tape & Reel)

Tape & Reel Spec's: 24mm wide, 8mm pitch, 13 inch reel (2000 pieces per reel)

5mm x 20mm FUSE HOLDERS

SLIM LINE

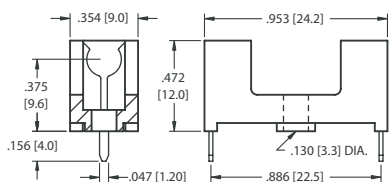

Mounting Detail

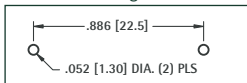

- Optional cover with window protects and insulates fuse
- Flame Retardant

CAT. NO. 4628 - Holder

CAT. NO. 4628C - Cover only (with window)

SPECIFICATIONS

Base & Cover: Nylon, UL Rated 94V-0
Clips: Brass, Tin Plate
Rated: 5 Amps @ 250V AC

LOW PROFILE

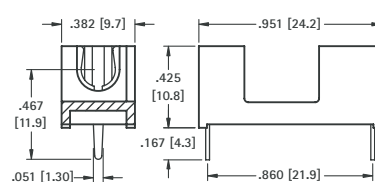

Mounting Detail

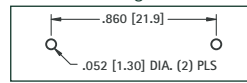

- Low profile, space saving design
- Optional cover protects and insulates fuse
- Flame Retardant

CAT. NO. 4527 - Holder

CAT. NO. 4527C - Cover only

SPECIFICATIONS

Base & Cover: Nylon, UL Rated 94V-0
Clips: Brass, Tin Plate
Rated: 5 Amps @ 250V AC

FULLY INSULATED

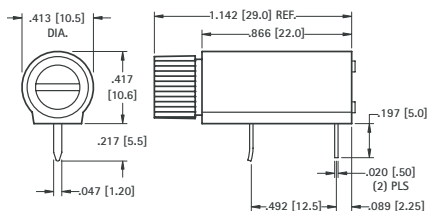

Mounting Detail

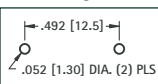

- Supplied unassembled
- Shock resistant
- Fuse can be accessed from board edge
- Fuse is completely enclosed, protecting use from shorting and breaking

CAT. NO. 4525

SPECIFICATIONS

Base: PBT
Contacts: Brass, Tin Plate
Rated: 10 Amps @ 250V AC

PC SNAP-IN

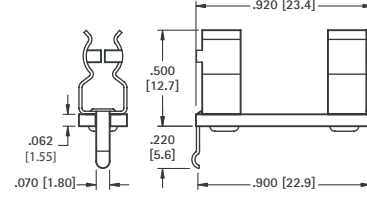

Mounting Detail

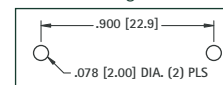

- Snap-in design for wave soldering
- Flame Retardant
- Optional cover protects and insulates fuse - **Cat. No. 3527C**

CAT. NO. 3527 - Holder

SPECIFICATIONS

Base: .062 (1.57) G-10, UL Rated 94V-0
Clips: Brass, Tin Plate
Rated: 6.3 Amps @ 250V AC

3AG FUSE HOLDERS

TERMINATION LUGS CAN BE USED WITH WIRES OR PC MOUNT

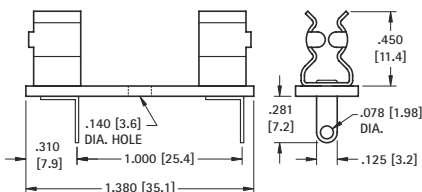

Mounting Detail

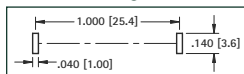

SPECIFICATIONS
Base: .062 (1.57) GPO-3, UL Rated 94V-0
Clips: Brass, Tin Plate
Rated: 15 Amps @ 500VAC

CAT. NO. 3526

Optional cover available - **Cat. No. 4245C**

PRESS-FIT, IDEAL FOR WAVE SOLDERING

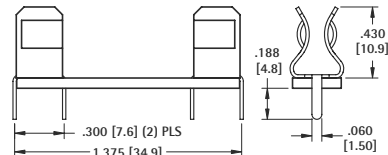

Mounting Detail

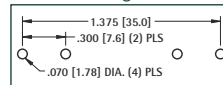

SPECIFICATIONS
Base: .062 (1.57) GPO-3, UL Rated 94V-0
Clips: Brass, Tin Plate
Rated: 15 Amps @ 500VAC

CAT. NO. 4245

Optional cover available - **Cat. No. 4245C**

SNAP-IN DESIGN ASSURES STABILITY DURING WAVE SOLDERING

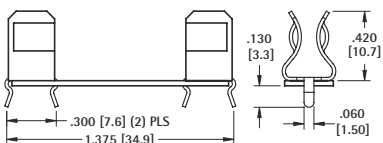

Mounting Detail

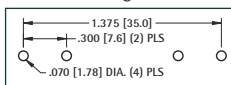

SPECIFICATIONS
Base: .032 (1.57) G-10, UL Rated 94V-0
Clips: Brass, Tin Plate
Rated: 15 Amps @ 500VAC

CAT. NO. 4250

Optional cover available - **Cat. No. 4245C**

MOLDED CASE

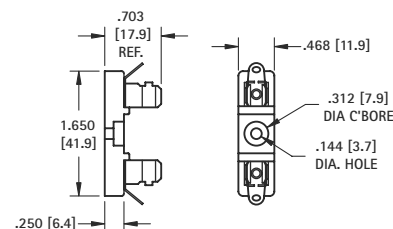

SPECIFICATIONS
Base: LCP, UL Rated 94V-0
Clips: .020 (.51) Brass - Nickel Plated
Rated: 15 Amps @ 500 VAC

CAT. NO. 3523

Optional cover available - **Cat. No. 4245C**

Mounting Hole: .144 (3.7) Dia.

5mm & 3AG FUSE HOLDERS

MIDGET, SPF (5AG) FUSE HOLDER

- Designed for SPF (Solar Protection Fuse)
- Optional cover will protect and insulate fuse
- Flame resistant

SPECIFICATIONS

Base & Cover: Nylon, UL Rated 94V-0

Clips: .030 (.76) Brass, Matte Tin Plate

Rated: 30 Amps

Operating Temp. Range: -58°F to +292°F (-50°C to +145°C)



3576 (THM)

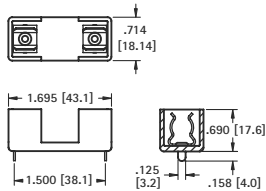

Optional Cover **Cat. No. 3576C**
fits Cat. No. 3576 & 3574

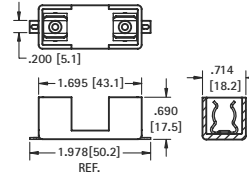

3574 (SMT)

Mounting Detail

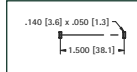

CAT. NO. 3574 - Holder

CAT. NO. 3576C - Cover only

Mounting Detail

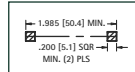

CAT. NO. 3576 - Holder

CAT. NO. 3576C - Cover only

3AG FUSE BLOCKS

- Available with fiberglass or phenolic base
- Fuse clips riveted to base for rugged applications

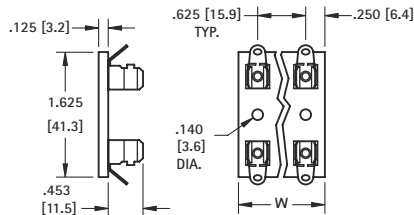

SPECIFICATIONS

Phenolic Base: XP, Black UL Rated 94-HB

Fiberglass Base: GPO-3 UL Rated 94 V-0

Clips: .020 (.51) Brass - Nickel Plated

Rated: 15 Amps @ 500 VAC

Operating Temp. Range: -58°F to +292°F (-50°C to +145°C)

BLACK PHENOLIC	FIBER-GLASS	HOLDS NO. OF FUSES	W
CAT. NO.	CAT. NO.		
3536	3540	1	.500 (12.7)
3537	3541	2	1.125 (28.6)
3538	3542	3	1.750 (44.5)
3539	3543	4	2.375 (60.3)

FUSE COVERS

- Made from flame retardant material
- Protects fuse from shorting and minor bumps



Can be used with clips 3512, 3512P, 3517 and 3518

MATERIAL: ABS, UL Rated 94V-0

CAT. NO.	FUSE SIZE
3517C	5mm x 20mm

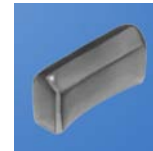
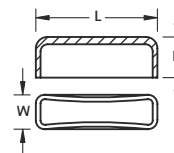
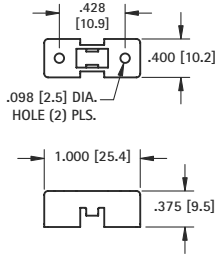

Can be used with clips or fuse holders

MATERIAL: PVC, UL Listed 94V-0

CAT. NO.	FUSE SIZE	L	W	H
3527C	5mm x 20mm	.945 (24.0)	.314 (8.0)	.512 (13.0)
3521C	2AG	.787 (20.0)	.295 (7.5)	.452 (11.5)
4245C	3AG	1.319 (33.5)	.472 (12.0)	.591 (15.0)

SUBMINIATURE FUSE HOLDERS

- Reliable spring tension assures low contact resistance
- Fuse holders allow for quick changing of subminiature fuses
- Ideal for high density circuit board applications

SPECIFICATIONS

Base: Thermoplastic, UL Rated 94V-0

Springs: Beryllium Copper, Gold Plate

Pins: Brass, Tin Plate

Current Rating: 5 Amps @ 250V AC



.335 (8.5) x .158 (4.0) FUSE

For Littelfuse 392/395 Type TE5®
Bussmann: PC Series
or equivalent



.335 (8.5) DIA. FUSE

For Littelfuse 370 Type TR5®
Bussmann: BK-EFF series
or equivalent

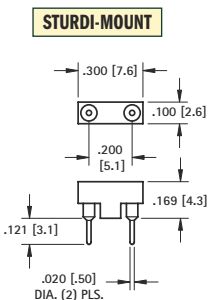

CAT. NO. 3552

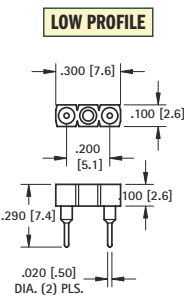

CAT. NO. 3553

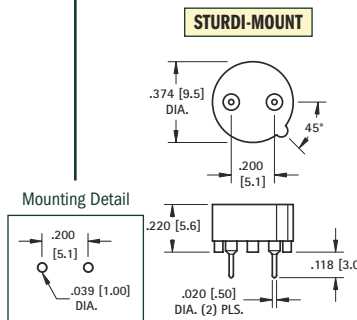

CAT. NO. 3556

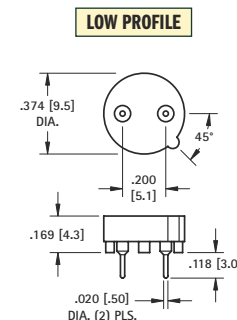

CAT. NO. 3554

FUSE CLIPS

Underwriters Laboratories, Inc.
Recognized Component Program —
UL File Number E354010



UL file number E354010 has been assigned to Keystone Electronics' fuse clips with end stops. (Refer to pages 44-45) Indicating recognition by Underwriters Laboratories Inc. that they are in compliance with their component program.

- Available for 5mm, 1AG, 2AG, 3AG, 5AG, 7AG & 8AG sizes
- Low profile, space saving
- Low contact resistance
- Withstands shock and vibration
- Rated 6.3 to 30 Amps
- Custom designs and modifications available to your specifications

Refer to pages 46-47 for Fuse Clip Layout and Mounting Details

PC THRU MOUNT TYPES

- Snap-fit design enhances assembly and PC retention for wave soldering
- Available with orientation legs to assure proper PC installation
- Available with or without end stops

SURFACE MOUNT & RIVET TYPES

- Available with solder lugs or quick-fit tabs .187 (4.7), .205 (5.2)

5mm PC Clips



MATERIAL:
 .020 (.51) Brass, Tin Plate
Current Rating: 15 Amps

CAT. NO.	A	B
3517	.060 (1.5)	.060 (1.5)
3518P	.060 (1.5)	.093 (2.4)

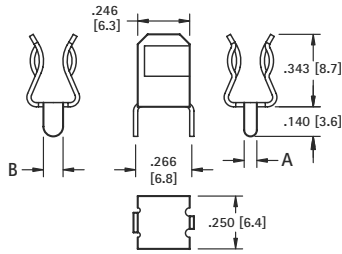

With or Without Orientation Legs
 Optional cover available - Cat. No. 3517C

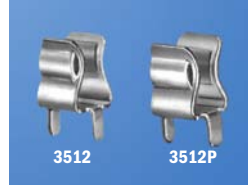

• With snap-in PC legs
MATERIAL:
 .020 (.51) Brass, Tin Plate
Current Rating: 15 Amps

CAT. NO.	A	B
3512	.060 (1.5)	.060 (1.5)
3512P	.060 (1.5)	.093 (2.4)

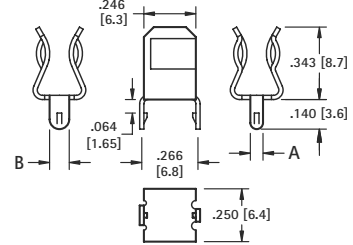

With or Without Orientation Legs
 Optional cover available - Cat. No. 3517C

FUSE CLIPS



MATERIAL:
 .016 (.41) Brass, Tin Plate
Current Rating: 6.3 Amps

CAT. NO. 3520

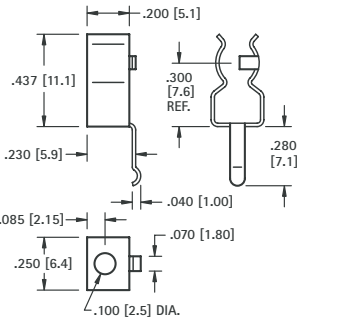

MATERIAL:
 .016 (.41) Brass, Tin Plate
Current Rating: 15 Amps

CAT. NO. 3519

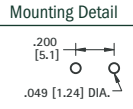
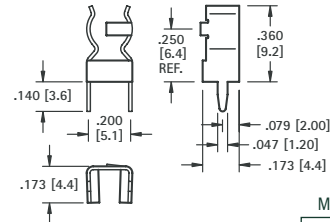

2AG or 5mm



MATERIAL: .016 (.41) Brass, Tin Plate
Current Rating: 15 Amps

CAT. NO.	PC LEGS	END STOP
3521	YES	YES
3621	YES	NO*
3561	NO	YES
3622	NO	NO*

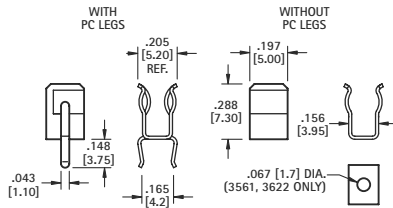

Mounting Detail
 Cat. No. 3521 & 3621 Only

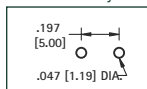

5mm/3AG



MATERIAL:
 .016 (.41) Brass, Tin Plate
Current Rating: 15 Amps

CAT. NO. 3562

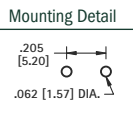
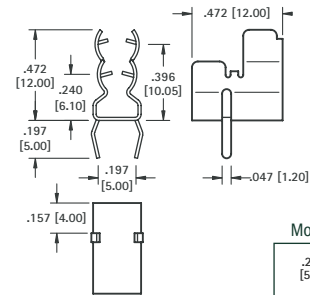

4AG (9/32 Dia.)

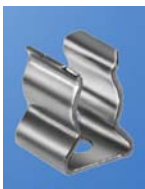

MATERIAL:
 .020 (.51) Brass, Nickel Plate
Current Rating: 15 Amps

CAT. NO. 3565 (Without End Stops)*

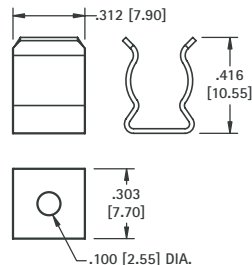

5AG (13/32 Dia.) - Solar Protection Fuse



MATERIAL:
 .030 (.76) Brass, Tin Plate
Current Rating: 30 Amps

CAT. NO. 3566

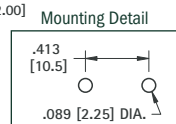
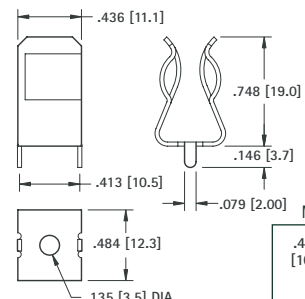

*Fuse clips without end stops are not UL recognized

Refer to pages 46-49 for Fuse Clip Layout and Mounting Details

WITH SNAP-IN PC LEGS

1AG, 3AG, 7AG, 8AG THRU HOLE MOUNT TYPES

WITH SNAP-IN PC LEGS



MATERIAL:
.020 (.51) Brass, Tin Plate
Current Rating: 15 Amps

CAT. NO. 3513

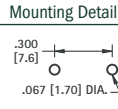
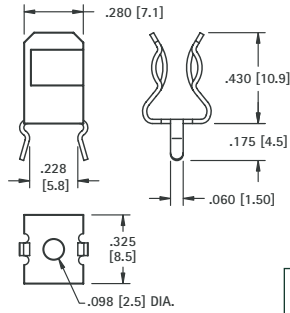

MATERIAL:
.020 (.51) Brass, Tin Plate
Current Rating: 15 Amps

CAT. NO.	A	B
3515	.060 (1.5)	.060 (1.5)
3515P	.060 (1.5)	.093 (2.4)
3516P	.060 (1.5)	.120 (3.0)

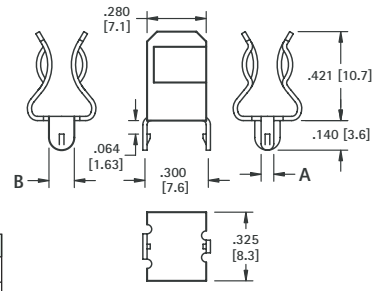

With or Without Orientation Legs

WITH STRAIGHT PC LEGS



MATERIAL:
.020 (.51) Brass, Tin Plate
Current Rating: 15 Amps

CAT. NO. 3530

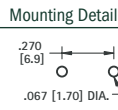
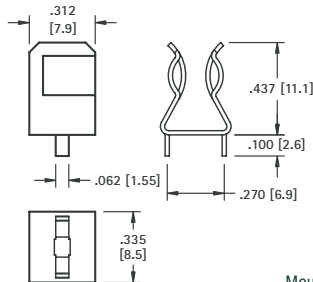

WITH STRAIGHT PC LEGS



MATERIAL:
.020 (.51) Brass, Tin Plate
Current Rating: 15 Amps

CAT. NO.	H	L	END STOPS
3510	.421 (10.7)	.140 (3.6)	NO*
3529	.421 (10.7)	.140 (3.6)	YES
3511	.430 (10.9)	.250 (6.4)	NO*
3514	.430 (10.9)	.250 (6.4)	YES

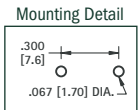
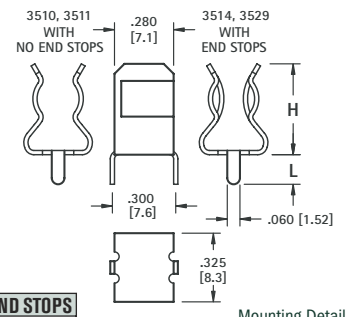

WITH SOLDER LUG

1AG, 3AG, 7AG, 8AG RIVET & SURFACE MOUNT TYPES

LOW PROFILE



MATERIAL:
.020 (.51) Brass, Nickel Plate
Current Rating: 15 Amps

CAT. NO.	A	B
3533	Flat	.656 (16.7)
3535	45°	.562 (14.3)
3570	-	NO TAB

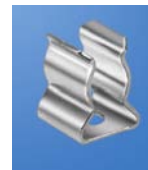
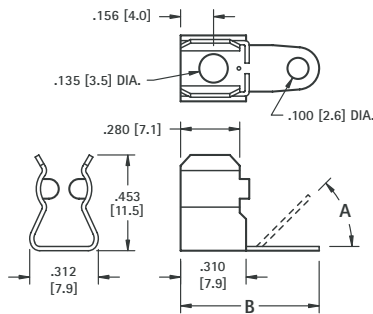

MATERIAL:
.020 (.51) Brass, Nickel Plate
Current Rating: 15 Amps

CAT. NO. 3531 (Without End Stops)*

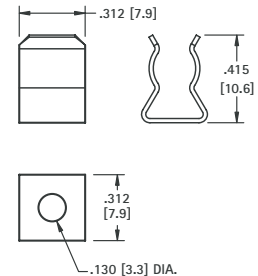

WITH QUICK-FIT TAB



MATERIAL:
.020 (.51) Brass, Nickel Plate
Current Rating: 15 Amps

CAT. NO.	TAB
4246	.187 (4.7)
4247	.205 (5.2)

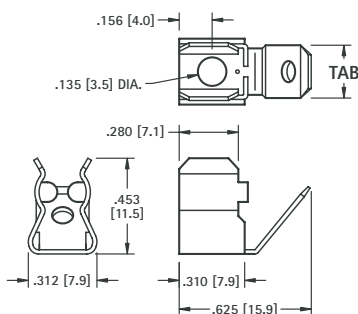

WITH OR WITHOUT END STOPS



MATERIAL:
.020 (.51) Brass, Nickel Plate
Current Rating: 15 Amps

CAT. NO.	END STOPS
3532	YES
3567	NO*

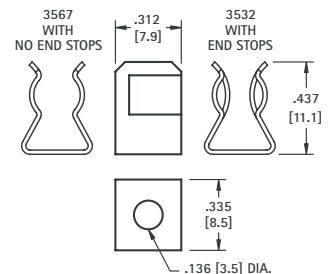

*Fuse clips without end stops are not UL recognized

REFER TO PAGE 44 FOR PART DIMENSIONS

NOTE: ALL MOUNTING DIMENSIONS ARE FOR REFERENCE ONLY. PLEASE VERIFY YOUR FUSE LAYOUT PRIOR TO FABRICATION.



3517

CAT. NO. 3517	
FUSE SIZE	L DIM.
5mm × 20mm	.910 (23.1)

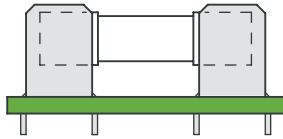
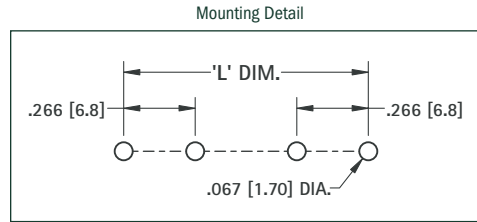

FIGURE 1



3517



3518P

CAT. NO. 3518P	
FUSE SIZE	L DIM.
5mm × 20mm	.910 (23.1)

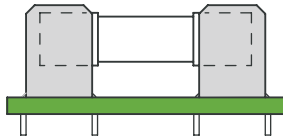
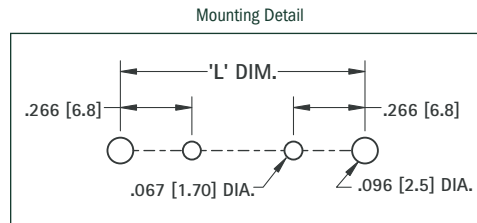

FIGURE 2



3518P



3512

CAT. NO. 3512	
FUSE SIZE	L DIM.
5mm × 20mm	.910 (23.1)

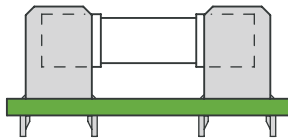
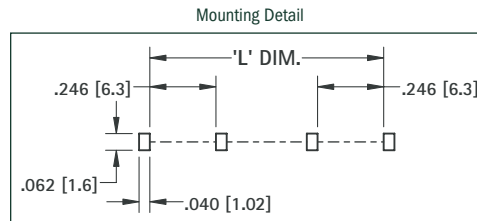

FIGURE 3



3512



3512P

CAT. NO. 3512P	
FUSE SIZE	L DIM.
5mm × 20mm	.910 (23.1)

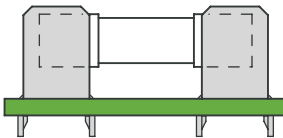
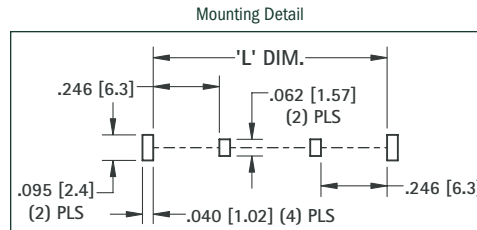

FIGURE 4



3512P



3520

CAT. NO. 3520	
FUSE SIZE	L DIM.
5mm × 20mm	.900 (22.9)

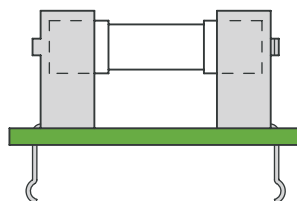
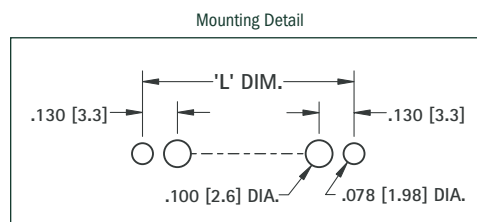

FIGURE 5



3520

REFER TO PAGE 44 FOR PART DIMENSIONS

NOTE: ALL MOUNTING DIMENSIONS ARE FOR REFERENCE ONLY. VERIFY YOUR FUSE LAYOUT PRIOR TO FABRICATION.



3519

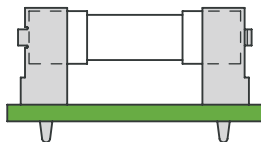
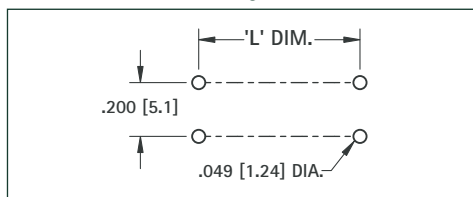

FIGURE 6

Mounting Detail



3519

CAT. NO. 3519	
FUSE SIZE	L DIM.
5mm × 20mm	.650 (16.5)



3521



FIGURE 7

Mounting Detail

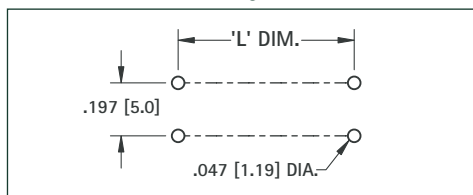

3521

CAT. NO. 3521	
FUSE SIZE	L DIM.
2AG	.514 (13.1)
5mm × 20mm	.710 (18.1)



3561

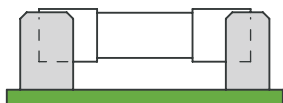
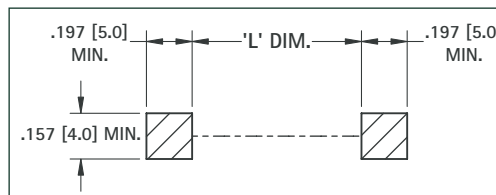

FIGURE 8

Pad Layout



3561

CAT. NO. 3561	
FUSE SIZE	L DIM.
2AG	.354 (9.0)
5mm × 20mm	.500 (12.7)

FIGURE 9



3562

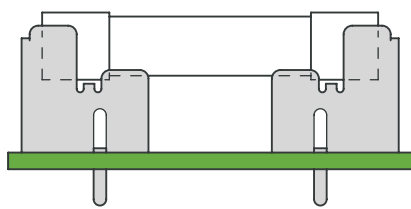

3AG

Mounting Detail

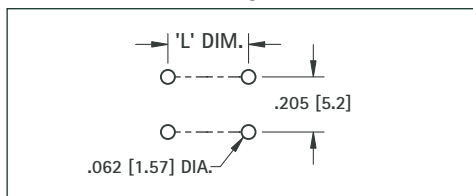

3562

CAT. NO. 3562	
FUSE SIZE	L DIM.
5mm × 20mm	.820 (20.9)
3AG	

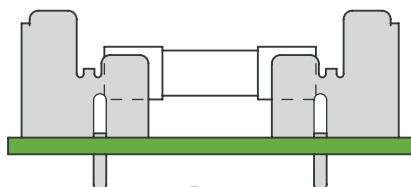

5mm

REFER TO PAGES 44 & 45 FOR PART DIMENSIONS

NOTE: ALL MOUNTING DIMENSIONS ARE FOR REFERENCE ONLY. PLEASE VERIFY YOUR FUSE LAYOUT PRIOR TO FABRICATION.

FIGURE 10



3565

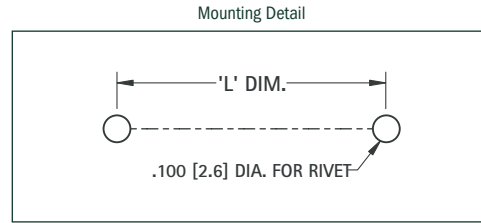
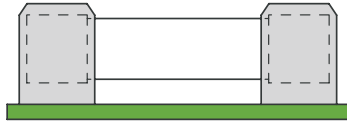

3565

CAT. NO. 3565		
DESIGNATION	FUSE SIZE	L DIM.
4AG	.281 (7.1) × 1.250 (31.8)	1.000 (25.4)

FIGURE 11



3566

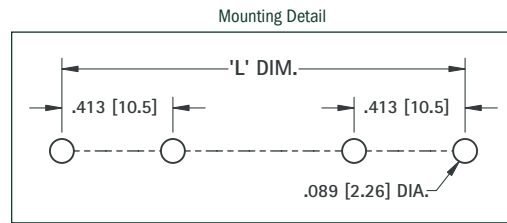
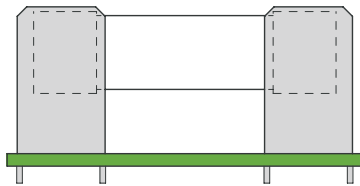

3566

CAT. NO. 3566		
DESIGNATION	FUSE SIZE	L DIM.
SM/SS	.406 (10.3) × 1.375 (34.9)	1.515 (38.5)
5AG	.406 (10.3) × 1.500 (38.1)	1.640 (41.7)

FIGURE 12



3529

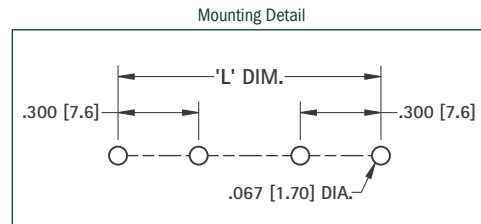
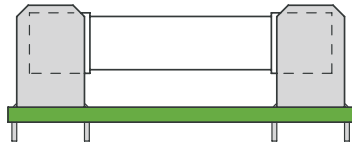

3514

CAT. NO. 3510, 3511, 3513, 3514, 3529		
DESIGNATION	FUSE SIZE	L DIM.
1AG	.250 (6.4) × .625 (15.9)	.750 (19.1)
7AG	.250 (6.4) × .875 (22.2)	1.000 (25.4)
8AG	.250 (6.4) × 1.000 (25.4)	1.125 (28.6)
3AG	.250 (6.4) × 1.250 (31.8)	1.375 (34.9)

FIGURE 13



3516P

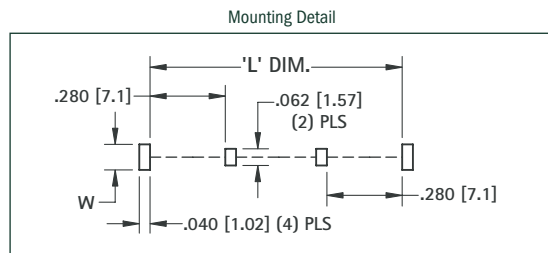
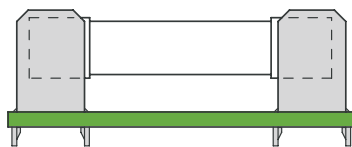

3515

CAT. NO. 3515, 3515P, 3516P		
DESIGNATION	FUSE SIZE	L DIM.
1AG	.250 (6.4) × .625 (15.9)	.735 (18.7)
7AG	.250 (6.4) × .875 (22.2)	.985 (25.0)
8AG	.250 (6.4) × 1.000 (25.4)	1.100 (28.0)
3AG	.250 (6.4) × 1.250 (31.8)	1.360 (34.6)

ORIENTATION LEGS	
CAT. NO.	W
3515	.062 (1.57)
3515P	.095 (2.4)
3516P	.122 (3.1)

REFER TO PAGE 45 FOR PART DIMENSIONS

NOTE: ALL MOUNTING DIMENSIONS ARE FOR REFERENCE ONLY. VERIFY YOUR FUSE LAYOUT PRIOR TO FABRICATION.



3530

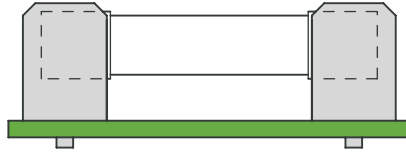

FIGURE 14

FOR THRU HOLE MOUNT APPLICATIONS



3530

Mounting Detail

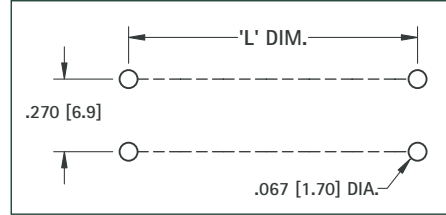

FOR CAT. NO. 3530

DESIGNATION	FUSE SIZE	L DIM.
1AG	.250 (6.4) × .625 (15.9)	.450 (11.4)
7AG	.250 (6.4) × .875 (22.2)	.700 (17.8)
8AG	.250 (6.4) × 1.000 (25.4)	.825 (21.0)
3AG	.250 (6.4) × 1.250 (31.8)	1.075 (27.3)



3570

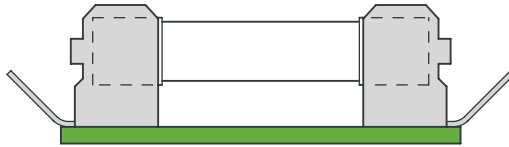

FIGURE 15

FOR RIVET MOUNT APPLICATIONS



3535

Mounting Detail

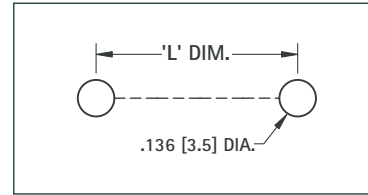

FOR CAT. NO. 3531, 3533, 3535, 3570, 4246, 4247

DESIGNATION	FUSE SIZE	L DIM.
1AG	.250 (6.4) × .625 (15.9)	.450 (11.4)
7AG	.250 (6.4) × .875 (22.2)	.700 (17.8)
8AG	.250 (6.4) × 1.000 (25.4)	.825 (21.0)
3AG	.250 (6.4) × 1.250 (31.8)	1.075 (27.3)



4247



FIGURE 16

FOR SURFACE MOUNT APPLICATIONS



3533

Pad Layout

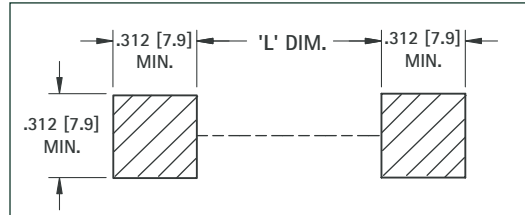

FOR CAT. NO. 3531, 3533, 3535, 3570, 4246, 4247

DESIGNATION	FUSE SIZE	L DIM.
1AG	.250 (6.4) × .625 (15.9)	.120 (3.0)
7AG	.250 (6.4) × .875 (22.2)	.365 (9.3)
8AG	.250 (6.4) × 1.000 (25.4)	.490 (12.4)
3AG	.250 (6.4) × 1.250 (31.8)	.740 (18.8)



3532

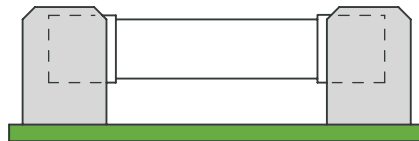

FIGURE 17

FOR SURFACE MOUNT APPLICATIONS



3567

Pad Layout

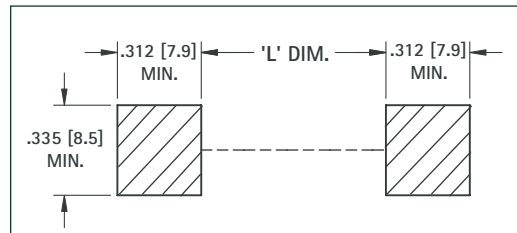

FOR CAT. NO. 3532, 3567

DESIGNATION	FUSE SIZE	L DIM.
1AG	.250 (6.4) × .625 (15.9)	.195 (5.0)
7AG	.250 (6.4) × .875 (22.2)	.445 (11.3)
8AG	.250 (6.4) × 1.000 (25.4)	.570 (14.5)
3AG	.250 (6.4) × 1.250 (31.8)	.820 (20.8)

THIS DOCUMENT IS THE PROPERTY OF KEYSTONE ELECTRONICS CORP. AND SHALL NOT BE REPRODUCED, DISTRIBUTED OR USED AS A BASIS FOR MANUFACTURE WITHOUT PRIOR WRITTEN PERMISSION FROM KEYSTONE ELECTRONICS CORP.

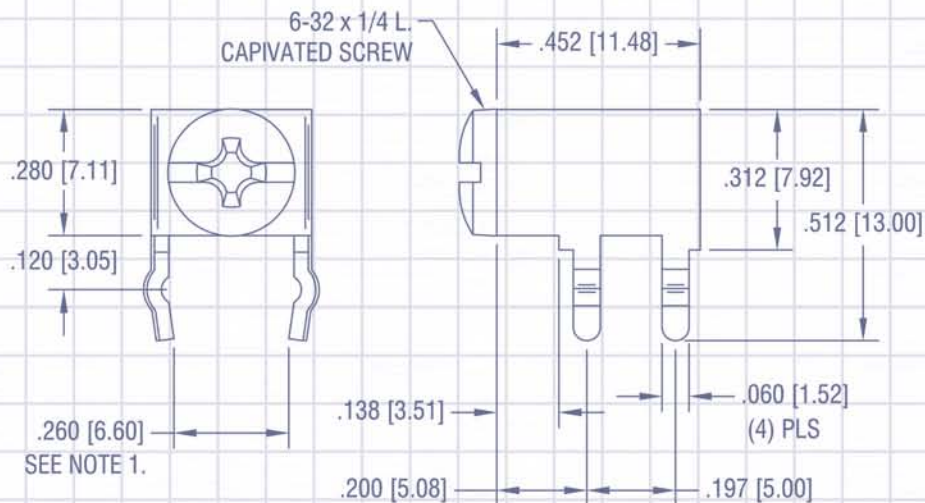
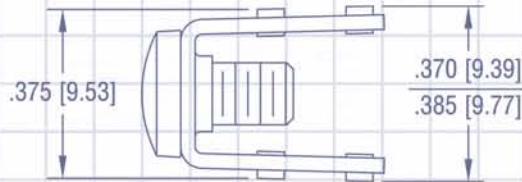
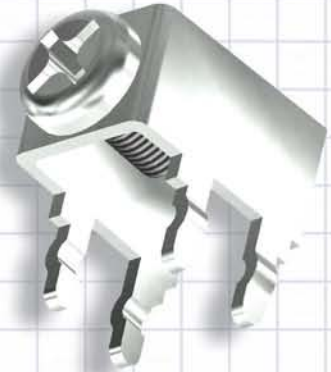

TERMINALS & TEST POINTS

Today's high tech electronics require space saving, low cost methods for connecting and testing circuitry. Our complete line of PC terminals, screw terminals, headers and test points are designed to meet the interconnect and testing challenges for electronic and electrical component termination points. Applications include:

- Multi-Insertion applications
- Replacement for pc screw edge connectors, blocks or strips
- Surface mount and thru-hole PCB designs
- UL approved devices

Our quality system is ISO 9001:2008 certified. Our products are in compliance with the RoHS and REACH directives. We provide 3D modeling, CAD and other application-engineering support for modifications, special designs or assembly requirements to assist you in choosing the right Keystone product for your application.

DATE

DESCRIPTION

REV.

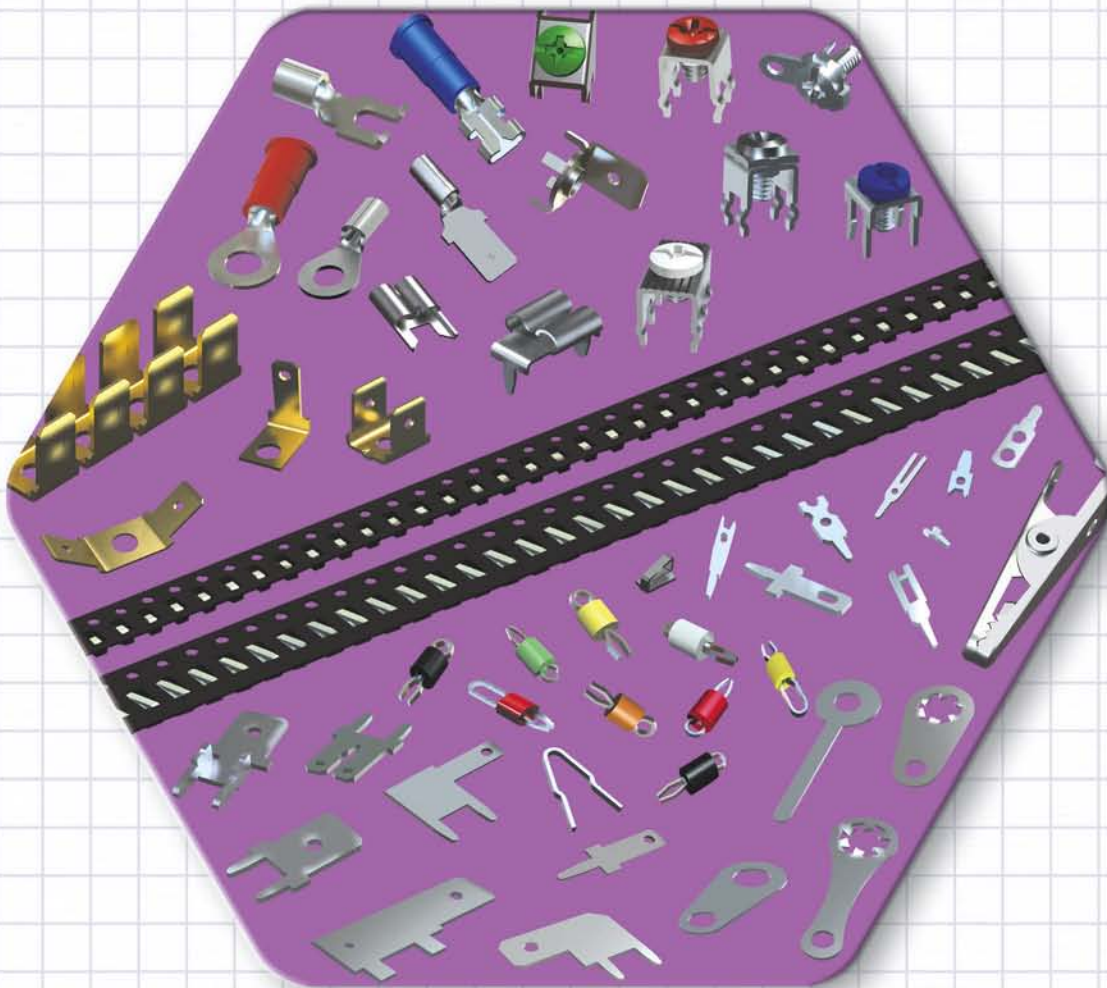

SECTION CONTENTS

ALLIGATOR CLIPS61	Female55
SCREW TERMINALS		Headers54
Binding Post66,67	SOLDER LUGS58
Color Coded, PC62-63	SOLDERLESS TERMINALS56-57
Heavy Duty63, 65, 66	TEST POINTS	
Metric65	Color Coded60
SEMS Screw64	THM (Thru Hole Mount)59-60
Swage Mount66-67	SMT (Surface Mount)61
QUICK FIT TERMINALS			
Male52-54		

PC QUICK-FIT MALE TERMINALS

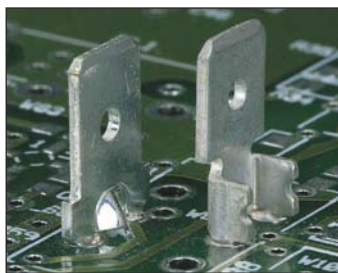

Underwriters Laboratories, Inc.
Recognized Component Program —
UL File Number E201546



UL file number E201546 has been assigned to Keystone Electronics' "Quick-Fit" terminals (Refer to pages 52-54) indicating recognition by Underwriters Laboratories Inc. that they are in compliance with their component program.

Underwriters Laboratories Inc. component program assures that "Quick-Fit" terminals meet the dimensional and performance requirements of the National Electrical Manufacturers Association specification number NEMA2-1982-(1988) and UL310.



.110 (2.8) TAB

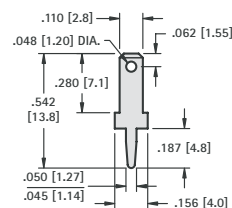

CAT. NO.	MATERIAL	MTG. HOLE
1267	.020 (.50) Brass, Tin Plate	.046 (1.2) Dia.
1211	.032 (.80) Brass, Tin Plate	.052 (1.3) Dia.

.110 (2.8) TAB

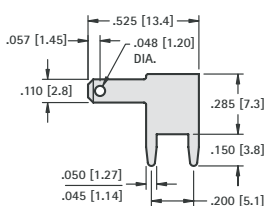

CAT. NO.	MATERIAL	MTG. HOLES
4903	.020 (.50) Brass, Tin Plate	.046 (1.2) Dia.
4906	.032 (.80) Brass, Tin Plate	.052 (1.3) Dia.

.110 (2.8) & .187 (4.8) TAB

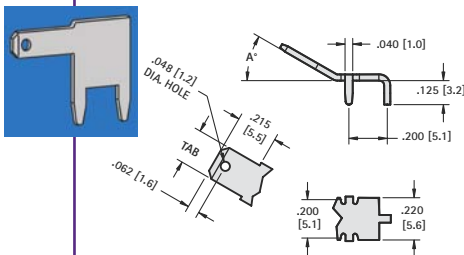

Material: .020 (.50) Brass, Tin Plate
Mtg Holes: .046 (1.2) Dia.

.110 (2.8) TAB CAT. NO.	A ANGLE	.187 (4.8) TAB CAT. NO.
4915*	0°	4918*
4916*	30°	4919*
4917*	60°	4920*

.187 (4.8) TAB

STURDI-MOUNT

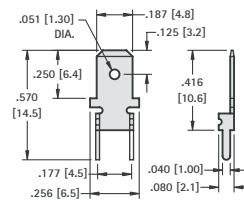

CAT. NO.	MATERIAL	MTG. HOLES
4900	.020 (.50) Brass, Tin Plate	.043 (1.1) Dia.

.187 (4.8) TAB

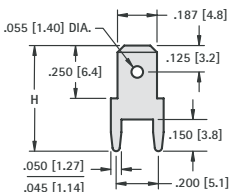

Material: Brass, Tin Plate

CAT. NO.	H	MATL THICK	MTG. HOLES
1285	.500 (12.7)	.020 (.50)	.046 (1.2) Dia.
1212	.500 (12.7)	.032 (.80)	.052 (1.3) Dia.
1216	.860 (21.8)	.032 (.80)	.052 (1.3) Dia.

.187 (4.8) TAB

STURDI-MOUNT

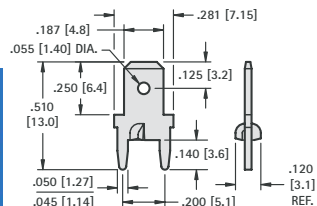

CAT. NO.	MATERIAL	MTG. HOLES
1285-ST	.020 (.50) Brass, Tin Plate	.046 (1.2) Dia.
1212-ST	.032 (.80) Brass, Tin Plate	.052 (1.3) Dia.

.187 (4.8) TAB

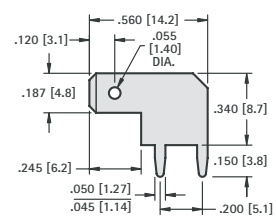

CAT. NO.	MATERIAL	MTG. HOLES
4904	.020 (.50) Brass, Tin Plate	.046 (1.2) Dia.
4907	.032 (.80) Brass, Tin Plate	.052 (1.3) Dia.

.205 (5.2) TAB

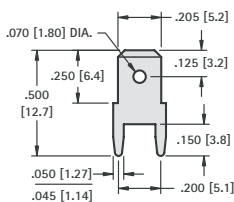

CAT. NO.	MATERIAL	MTG. HOLES
1286	.020 (.50) Brass, Tin Plate	.046 (1.2) Dia.
1213	.032 (.80) Brass, Tin Plate	.052 (1.3) Dia.

.205 (5.2) TAB

STURDI-MOUNT

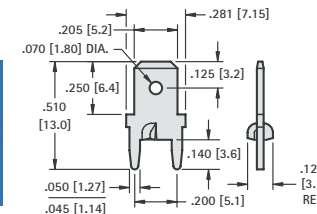

CAT. NO.	MATERIAL	MTG. HOLES
1286-ST	.020 (.50) Brass, Tin Plate	.046 (1.2) Dia.
1213-ST	.032 (.80) Brass, Tin Plate	.052 (1.3) Dia.

.205 (5.2) TAB

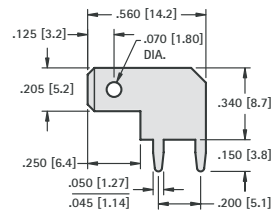

CAT. NO.	MATERIAL	MTG. HOLES
4905*	.020 (.50) Brass, Tin Plate	.046 (1.2) Dia.
4909*	.032 (.80) Brass, Tin Plate	.052 (1.3) Dia.

* Not UL Recognized

PC QUICK-FIT TERMINALS



.250 (6.4) TAB

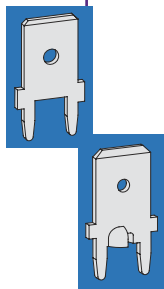
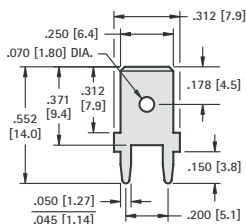

CAT. NO.	MATERIAL	MTG. HOLES
1287	.032 (.80) Brass, Tin Plate	.052 (1.3) Dia.

.250 (6.4) TAB

STURDI-MOUNT

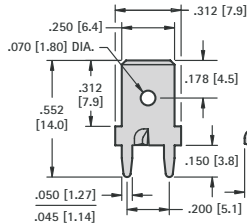

CAT. NO.	MATERIAL	MTG. HOLES
1287-ST	.032 (.80) Brass, Tin Plate	.052 (1.3) Dia.

DUAL .110 (2.8)/.250 (6.4) TAB

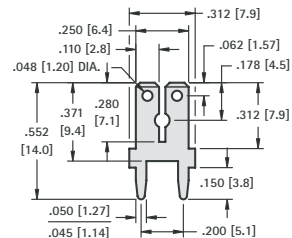

CAT. NO.	MATERIAL	MTG. HOLES
1282	.032 (.80) Brass, Tin Plate	.052 (1.3) Dia.

.250 (6.4) TAB

STURDI-MOUNT

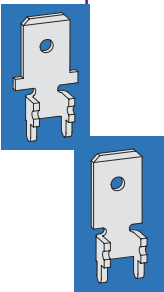
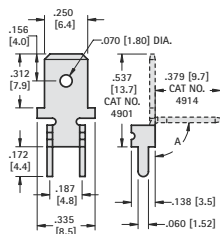

MATERIAL: .032 (.80) Brass, Matte Tin Plate

CAT. NO.	ANGLE A	MTG. HOLES
4901	0°	.067 (1.7) Dia.
4914*	90°	

.250 (6.4) TAB

STURDI-MOUNT

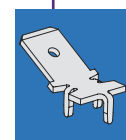
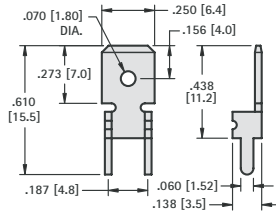

CAT. NO.	MATERIAL	MTG. HOLES
4902	.032 (.80) Brass, Tin Plate	.067 (1.7) Dia.

.250 (6.4) TAB

STURDI-MOUNT

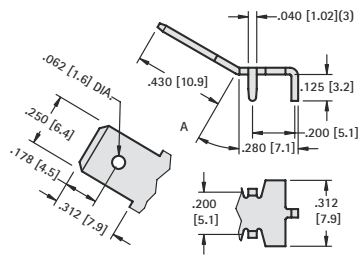

MATERIAL: .032 (.80) Brass, Matte Tin Plate

CAT. NO.	ANGLE A	MTG. HOLES
4910	0°	.052 (1.3) Dia.
4908	30°	
4912	60°	

.250 (6.4) TAB

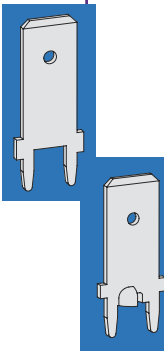
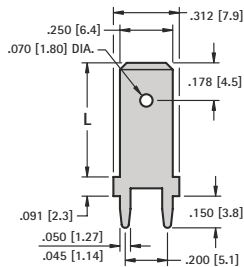

MATERIAL: .032 (.80) Brass, Matte Tin Plate

CAT. NO.	"L"	MTG. HOLES
1289	.540 (13.7)	.067 (1.7) Dia.
1292	.710 (18.0)	

.250 (6.4) TAB

STURDI-MOUNT

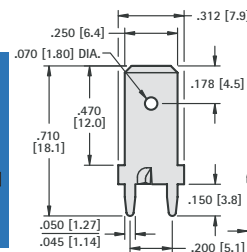

CAT. NO.	MATERIAL	MTG. HOLES
1289-ST	.032 (.80) Brass, Tin Plate	.052 (1.3) Dia.

.250 (6.4) TAB

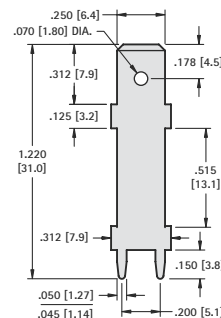

CAT. NO.	MATERIAL	MTG. HOLES
1281	.032 (.80) Brass, Tin Plate	.052 (1.3) Dia.

.250 (6.4) TAB

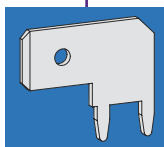
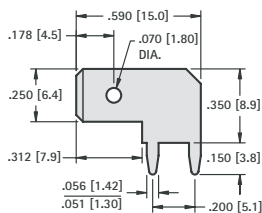

CAT. NO.	MATERIAL	MTG. HOLES
4966	.032 (.80) Brass, Tin Plate	.056 (1.4) Dia.

.250 (6.4) TAB

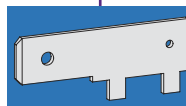
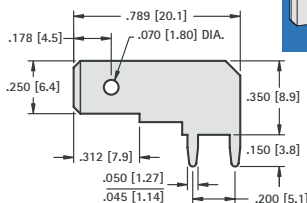

CAT. NO.	MATERIAL	MTG. HOLES
1266	.032 (.80) Brass, Tin Plate	.052 (1.3) Dia.

.250 (6.4) TAB

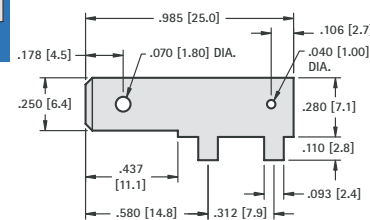

CAT. NO.	MATERIAL	MTG. HOLES
1265*	.032 (.80) Brass, Tin Plate	.106 (2.7) Dia.

* Not UL Recognized

.250 (6.4) "STURDI-MOUNT" PC QUICK-FIT HEADERS

AVAILABLE IN BRASS OR STEEL TABS

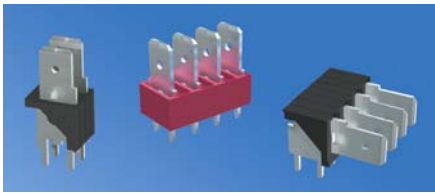

- Ideal for rugged multi-insertion applications
- Pre-assembled header reduces PC assembly costs
- Increases PC board retention strength
- Keeps terminals perpendicular
- Maintains position for wave soldering

SPECIFICATIONS

Material: .032 (.80) Brass or Steel, Tin Plated
Insulator: Thermoplastic, UL Rated 94V-0
Current Rating: 15 Amps @ 500V AC
Temperature Rating: -58°F to +292°F (-50°C to +145°C)

HORIZONTAL

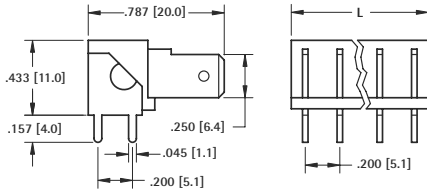

BRASS TABS	STEEL TABS	NO. OF TABS	L DIM.
7802	7822	2	.362 (8.2)
7803	7823	3	.562 (14.3)
7804	7824	4	.762 (19.4)
7805	7825	5	.962 (24.4)
7806	7826	6	1.162 (29.5)

VERTICAL

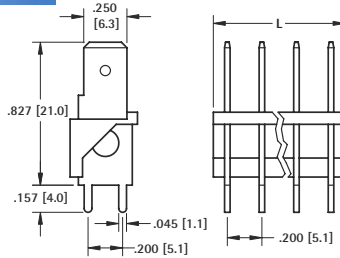

BRASS TABS	STEEL TABS	NO. OF TABS	L DIM.
7812	7832	2	.362 (8.2)
7813	7833	3	.562 (14.3)
7814	7834	4	.762 (19.4)
7815	7835	5	.962 (24.4)
7816	7836	6	1.162 (29.5)

LOW PROFILE

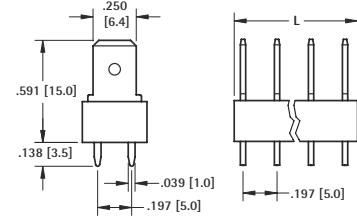

BRASS TABS	STEEL TABS	NO. OF TABS	L DIM.
7817	7827	2	.320 (8.1)
7818	7828	3	.517 (13.1)
7819	7829	4	.713 (18.1)
7820	7830	5	.910 (23.1)
7821	7831	6	1.107 (28.1)

RIVET MOUNT QUICK-FIT TERMINALS



- UL recognized bright brass Quick-Fit terminals
- Rivet mount male tab versions meet NEMA 2-E201546 & UL 310 specifications
- Designed for repeated mating cycles
- For tabs 0.110 (2.8mm) to 0.250 (6.4mm)

.110 (2.8) - .187 (4.8) - .250 (6.4) TABS

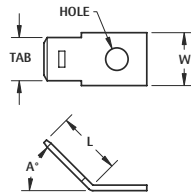
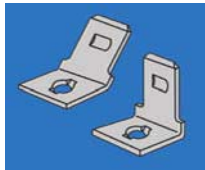

.110 (2.8) - .187 (4.8) - .250 (6.4) TABS

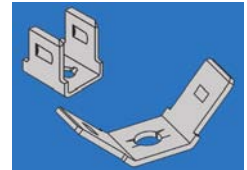
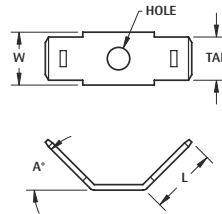

BRIGHT BRASS					MATTE TIN			
A = 45°	A = 90°	TAB SIZE	MAT'L THICK	L TAB	W WIDTH	HOLE DIA.	A = 45°	A = 90°
CAT. NO.	CAT. NO.						CAT. NO.	CAT. NO.
2004	2002	.110 (2.8)	.020 (.51)	.365 (9.3)	.180 (4.6)	.096 (2.4)	1233	1220
1271	1261	.187 (4.8)	.020 (.51)	.375 (9.5)	.250 (6.4)	.100 (2.5)	1234	1221
1280	1256	.250 (6.4)	.032 (.81)	.406 (10.3)	.306 (7.8)	.130 (3.3)	1235	1222

BRIGHT BRASS					MATTE TIN			
A = 45°	A = 90°	TAB SIZE	MAT'L THICK	L TAB	W WIDTH	HOLE DIA.	A = 45°	A = 90°
CAT. NO.	CAT. NO.						CAT. NO.	CAT. NO.
2005	2003	.110 (2.8)	.020 (.51)	.360 (9.1)	.180 (4.6)	.096 (2.4)	1240	1227
1263	1262	.187 (4.8)	.020 (.51)	.315 (8.0)	.250 (6.4)	.100 (2.5)	1241	1228
1258	1257	.250 (6.4)	.032 (.81)	.400 (10.1)	.306 (7.8)	.130 (3.3)	1242	1229

.110 (2.8) TAB

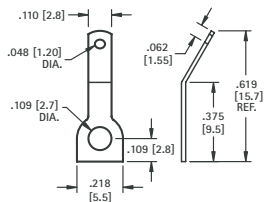

MATERIAL: .020 (.51) Brass, Tin Plate

CAT. NO.	ANGLE
1269	0°
1270	30°

.187 (4.8) - .205 (6.4) TABS

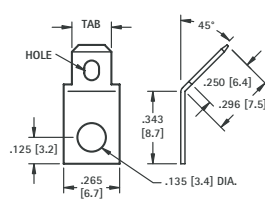

45° TAB MATERIAL: .020 (.51) Brass, Tin Plate

CAT. NO.	TAB	HOLE
4005	.205 (5.2)	.132 (3.4) x .070 (1.78) Slot
4095	.187 (4.7)	.078 (1.98) Dia. Hole

MULTIPLE .250 (6.4) TAB

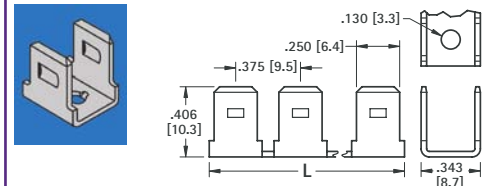

BRIGHT BRASS MATERIAL: .032 (.81) Bright Brass			
CAT. NO.	PAIRS	L	TAB SIZE
1005	2	.687 (17.4)	.250 (6.4)
1006	3	1.062 (27.0)	
1007	4	1.441 (36.6)	
1008	5	1.820 (46.2)	

PC QUICK-FIT FEMALE TERMINALS

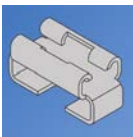

ACCEPTS **.110 (2.8) × .032 (.81) TAB**

SMT - HORIZONTAL ENTRY

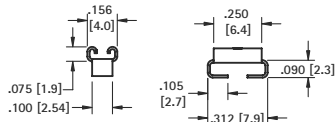

Mounting Detail

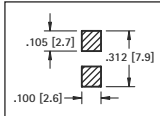

SPECIFICATIONS

Material: .012 (.30) Brass, Tin-Nickel Plate
Current Rating: 15 Amps @ 500V AC

CAT. NO. 3569* (Bulk)

CAT. NO. 3569TR* (Tape & Reel)

Tape & Reel Spec's: 24mm wide, 8mm pitch, 13 inch reel (2000 pieces per reel)

ACCEPTS **ALL TABS**

.110 (2.8) TO .50 (6.4) × .020 (.50) TO .032 (.80)

SMT - VERTICAL OR HORIZONTAL ENTRY

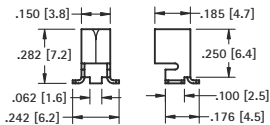

Mounting Detail

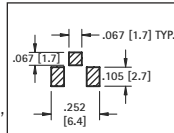

SPECIFICATIONS

Material: .016 (.40) Brass, Tin-Nickel Plate
Current Rating: 15 Amps @ 500V AC

CAT. NO. 3586* (Bulk)

CAT. NO. 3586TR* (Tape & Reel)

Tape & Reel Spec's: 16mm wide, 12mm pitch, 13 inch reel (750 pieces per reel)

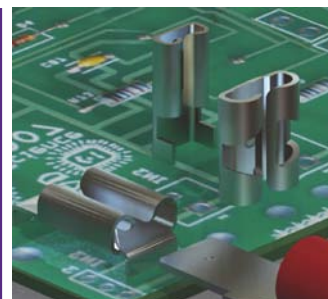

Underwriters Laboratories, Inc.
Recognized Component Program
 — UL File Number E201546

FEMALE PC QUICK-FIT TERMINALS

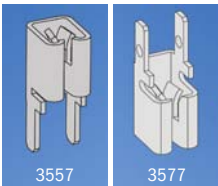

ACCEPTS **ALL TABS**

.110 (2.8) TO .50 (6.4) × .020 (.50) TO .032 (.80)

VERTICAL OR HORIZONTAL ENTRY

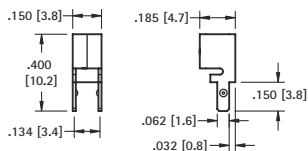

Mounting Detail
 Cat. No. 3557

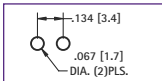

Mounting Detail
 Cat. No. 3577

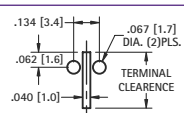

ACCEPTS **.187 (4.8), .205 (5.2), .250 (6.4) TAB**

HORIZONTAL ENTRY

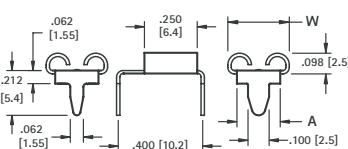

MATERIAL: Brass, Tin-Nickel Plate

CAT. NO.	ACCEPTS TAB	"W"	"A"	MATL THICK
3571	.187(4.8) × .020(.51)	.222 (5.6)	.162 (4.1)	.012 (.30)
3572*	.187(4.8) × .032(.81)			
3546	.205(5.2) × .020(.51)	.240 (6.1)	.180 (4.6)	.012 (.30)
3550	.205(5.2) × .032(.81)			
3547	.250(6.4) × .032(.81)	.291 (7.4)	.205 (5.2)	.016 (.41)

Mounting Detail

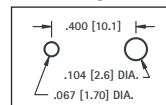

MATERIAL:

.016 (.41) Brass, Tin-Nickel Plate

CAT. NO.	ORIENTATION
3557	top & side entry
3577*	bottom entry

ACCEPTS **.110 (2.8) TAB**

HORIZONTAL ENTRY

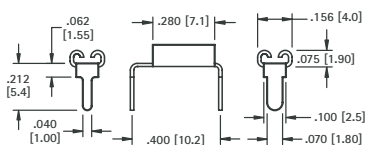

Mounting Detail

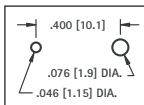

MATERIAL:

.012 (.30) Brass, Tin-Nickel Plate

CAT. NO.	ACCEPTS TAB
3545	.110 (2.8) × .020 (.51)
3549	.110 (2.8) × .032 (.81)

ACCEPTS **.110 (2.8) TAB**

VERTICAL ENTRY

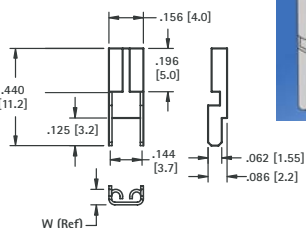
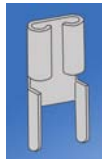

Mounting Detail

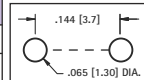

MATERIAL:

.012 (.30) Brass, Tin-Nickel Plate

CAT. NO.	ACCEPTS TAB	W
3534	.110(2.8) × .020(.51)	.070 (1.80)
3544	.110(2.8) × .032(.81)	.075 (1.92)

ACCEPTS **.187 (4.8) TAB**

VERTICAL ENTRY

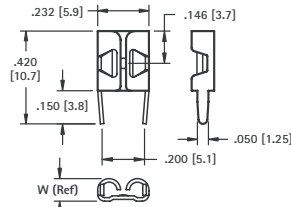

Mounting Detail

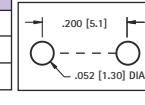

MATERIAL: .016 (.41) Brass, Tin-Nickel Plate

CAT. NO.	ACCEPTS TAB	"W"
3548	.187(4.8) × .020(.51)	.093 (2.36)
3578*	.187(4.8) × .020(.51)	.093 (2.36)
3551	.187(4.8) × .032(.81)	.102 (2.59)

*Low insertion force design

ACCEPTS **.205 (5.2) TAB**

VERTICAL ENTRY

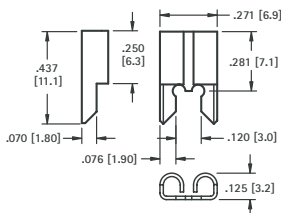
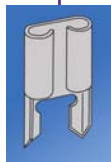

Mounting Detail

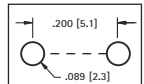

MATERIAL:

.016 (.41) Brass, Tin-Nickel Plate

CAT. NO.	ACCEPTS TAB
3525	.205 (5.2) × .020 (.51)
3575*	.205 (5.2) × .032 (.81)

ACCEPTS **.250 (6.4) TAB**

VERTICAL ENTRY

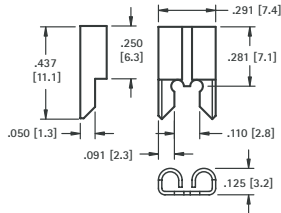
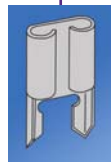

Mounting Detail

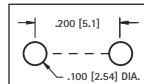

MATERIAL:

.016 (.41) Brass, Tin-Nickel Plate

CAT. NO.	ACCEPTS TAB
3528	.250 (6.4) × .032 (.81)

ACCEPTS **.312 (7.9) TAB**

OVER SIZED

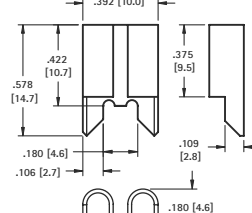
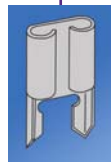

Mounting Detail

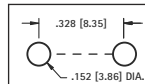

MATERIAL:

.020 (.51) Copper, Tin-Nickel Plate

CAT. NO. 3555

* Not UL Recognized



QUICK-FIT FEMALES

FEMALE NON-INSULATED

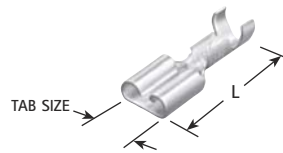

MATERIAL: Tinned Brass

Boot and Quick-Fit sold separately

CAT. NO.	MATES WITH MALE TAB WIDTH × THICK	L	AWG SIZE	MAT'L THICK
1252	.110 (2.8) × .020 (.51)	.640 (16.3)	18-22	.010 (.25)
1264	.187 (4.8) × .020 (.51)	.576 (14.6)	16-22	.013 (.33)
4469	.205 (5.2) × .020 (.51)	.640 (16.3)	16-20	.013 (.33)

VINYL BOOT

For .250 (6.4) QUICK-FITS

- Easily slips over terminal
- Insulates and protects

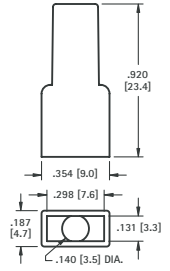

SOLDERLESS QUICK-FIT TERMINALS

SPECIFICATIONS: Terminals: EPT Copper Insulation: Vinyl **RoHS** (Non-RoHS Compliant)

MALE NON-INSULATED

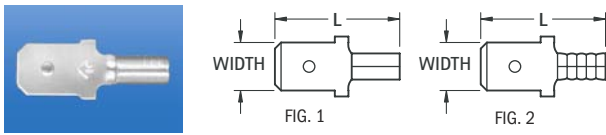

CAT. NO.	WIRE RANGE (AWG)	FIG.	MALE TAB		BARREL		
			WIDTH × THICK	L	LENGTH	I.D.	
8281	22/18	2	.187 (4.8) × .020 (.51)	.64 (16.3)	.24 (6.3)	.080 (2.03)	
8282		1	.250 (6.4) × .032 (.81)	.73 (18.5)	.25 (6.4)	.065 (1.65)	
8283	16/14	2	.187 (4.8) × .020 (.51)	.64 (16.3)	.24 (6.3)	.080 (2.03)	
8284		1	.250 (6.4) × .032 (.81)	.73 (18.5)	.25 (6.4)	.085 (2.16)	
8285	12/10	1	.250 (6.4) × .032 (.81)	.75 (19.1)	.25 (6.4)	.150 (3.8)	

FEMALE NON-INSULATED

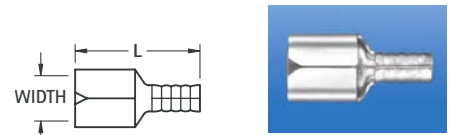

CAT. NO.	WIRE RANGE (AWG)	MATES WITH MALE TAB		L	BARREL .250 (6.4)	
		WIDTH × THICK	L		I.D.	
8272	22/18	.187 (4.8) × .020 (.51)	.58 (14.7)	.085 (2.16)		
8273		.250 (6.4) × .032 (.81)	.66 (16.8)	.080 (2.03)		
8274	16/14	.187 (4.8) × .020 (.51)	.58 (14.7)	.085 (2.16)		
8275		.250 (6.4) × .032 (.81)	.66 (16.8)	.080 (2.03)		

MALE VINYL INSULATED

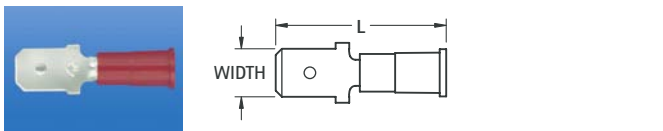

CAT. NO.	WIRE RANGE (AWG)	MALE TAB		L	BARREL		MAX INSULATION DIAMETER
		WIDTH × THICK	L		LENGTH	I.D.	
8286	22/18	.187 (4.8) × .020 (.51)	.85 (21.6)	.24 (6.3)	.080 (2.03)	.145 (3.7)	
8287	(Red)	.250 (6.4) × .032 (.81)	.93 (23.6)	.25 (6.4)	.065 (1.65)	.145 (3.7)	
8288	16/14	.187 (4.8) × .020 (.51)	.85 (21.6)	.24 (6.3)	.080 (2.03)	.145 (3.7)	
8289	(Blue)	.250 (6.4) × .032 (.81)	.93 (23.6)	.25 (6.4)	.085 (2.16)	.170 (4.3)	
8290	12/10 (Yellow)	.250 (6.4) × .032 (.81)	1.05 (26.7)	.25 (6.4)	.150 (3.8)	.250 (6.4)	

FEMALE VINYL INSULATED

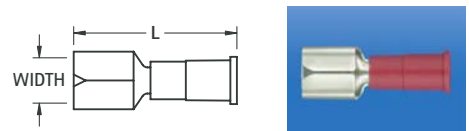

CAT. NO.	WIRE RANGE (AWG)	MATES WITH MALE TAB		L	BARREL .250 (6.4)		MAX INSULATION DIAMETER
		WIDTH × THICK	L		I.D.		
8276	22/18	.187 (4.8) × .020 (.51)	.78 (19.8)	.085 (2.16)			
8277	(Red)	.250 (6.4) × .032 (.81)	.87 (22.1)	.080 (2.03)			
8278	16/14	.187 (4.8) × .020 (.51)	.78 (19.8)	.085 (2.16)			
8279	(Blue)	.250 (6.4) × .032 (.81)	.87 (22.1)	.080 (2.03)			
8280	12/10 (Yellow)	.250 (6.4) × .032 (.81)	.96 (24.4)	.165 (4.2)			

MALE FULLY INSULATED NYLON

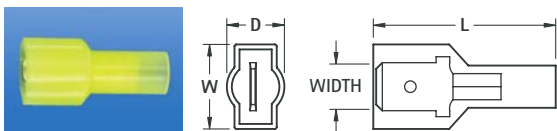

CAT. NO.	WIRE RANGE (AWG)	MALE TAB		L	W	D	BARREL .250 (6.4)		MAX. INSUL. DIA.
		WIDTH × THICK	L				LENGTH	I.D.	
8296	22/18	.187 (4.8) × .020 (.51)	.87 (22.1)	.37 (9.4)	.30 (7.6)	.24 (6.3)	.080 (2.03)	.145 (3.7)	
8297	(Red)	.250 (6.4) × .032 (.81)	.95 (24.1)	.44 (11.2)	.30 (7.6)	.25 (6.4)	.065 (1.65)	.145 (3.7)	
8298	16/14	.187 (4.8) × .020 (.51)	.87 (22.1)	.37 (9.4)	.30 (7.6)	.24 (6.3)	.080 (2.03)	.170 (4.3)	
8299	(Blue)	.250 (6.4) × .032 (.81)	.95 (24.1)	.44 (11.2)	.30 (7.6)	.25 (6.4)	.085 (2.16)	.170 (4.3)	
8300	12/10 (Yellow)	.250 (6.4) × .032 (.81)	1.05 (26.7)	.47 (11.9)	.39 (9.9)	.25 (6.4)	.150 (3.8)	.250 (6.4)	

FEMALE FULLY INSULATED NYLON

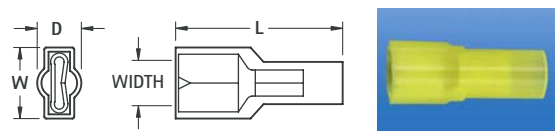

CAT. NO.	WIRE RANGE (AWG)	MATES WITH MALE TAB		L	W	D	BARREL .250 (6.4)		MAX. INSUL. DIA.
		WIDTH × THICK	L				I.D.		
8291	22/18	.187 (4.8) × .020 (.51)	.81 (20.6)	.30 (7.6)	.23 (5.8)	.085 (2.16)	.145 (3.7)		
8292	(Red)	.250 (6.4) × .032 (.81)	.87 (22.1)	.37 (9.4)	.23 (5.8)	.080 (2.03)	.145 (3.7)		
8293	16/14	.187 (4.8) × .020 (.51)	.81 (20.6)	.30 (7.6)	.23 (5.8)	.085 (2.16)	.145 (3.7)		
8294	(Blue)	.250 (6.4) × .032 (.81)	.87 (22.1)	.37 (9.4)	.23 (5.8)	.080 (2.03)	.170 (4.3)		
8295	12/10 (Yellow)	.250 (6.4) × .032 (.81)	.99 (25.1)	.39 (9.9)	.32 (8.1)	.165 (4.2)	.250 (6.4)		

SOLDERLESS TERMINALS

SPECIFICATIONS: Terminals: EPT Copper Insulation: Vinyl **RoHS** (Non-RoHS Compliant)

RING TONGUE NON-INSULATED

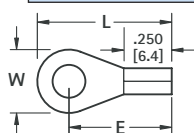

CAT. NO.	WIRE RANGE (AWG)	FOR STUD SIZE	W	L	E	MATL THICK	BARREL I.D.
8200	22/18	6	.25 (6.4)	.60 (15.2)	.47 (11.9)	.030 (.76)	.070 (1.78)
8201		8	.33 (8.4)	.70 (17.8)	.54 (13.7)		
8202		10	.33 (8.4)	.70 (17.8)	.54 (13.7)		
8203	16/14	6	.25 (6.4)	.60 (15.2)	.47 (11.9)	.030 (.76)	.090 (2.29)
8204		8	.33 (8.4)	.70 (17.8)	.54 (13.7)		
8205		10	.33 (8.4)	.70 (17.8)	.54 (13.7)		
8206	12/10	6	.28 (7.1)	.68 (17.3)	.54 (13.7)	.040 (1.02)	.135 (3.4)
8207		8	.38 (9.7)	.73 (18.5)	.54 (13.7)		
8208		10	.38 (9.7)	.73 (18.5)	.54 (13.7)		

RING TONGUE INSULATED

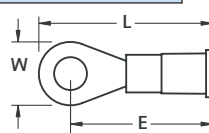

CAT. NO.	WIRE RANGE (AWG)	FOR STUD SIZE	W	L	E	MATL THICK	BARREL .250 (6.4) LONG I.D.	MAX. INSUL. DIA.
8209	22/18 (Red)	6	.25 (6.4)	.80 (20.3)	.67 (17.0)	.030 (.76)	.070 (1.78)	.145 (3.7)
8210		8	.33 (8.4)	.90 (22.9)	.74 (18.8)			
8211		10	.33 (8.4)	.90 (22.9)	.74 (18.8)			
8212	16/14 (Blue)	6	.25 (6.4)	.80 (20.3)	.67 (17.0)	.030 (.76)	.090 (2.29)	.170 (4.3)
8213		8	.33 (8.4)	.90 (22.9)	.74 (18.8)			
8214		10	.33 (8.4)	.90 (22.9)	.74 (18.8)			
8215	12/10 (Yellow)	6	.28 (7.1)	.98 (24.9)	.84 (21.3)	.040 (1.02)	.135 (3.4)	.250 (6.4)
8216		8	.38 (9.7)	1.03 (26.2)	.84 (21.3)			
8217		10	.38 (9.7)	1.03 (26.2)	.84 (21.3)			

BLOCK SPADE NON-INSULATED

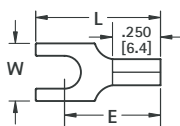

Flanged

CAT. NO.	WIRE RANGE (AWG)	FOR STUD SIZE	W	L	E	MATL THICK	BARREL I.D.	FLANGED CAT. NO.
8218	22/18	6	.30 (7.6)	.65 (16.5)	.50 (12.7)	.030 (.76)	.090 (2.29)	8236
8219		8						8237
8220		10						8238
8221	16/14	6	.30 (7.6)	.65 (16.5)	.50 (12.7)	.030 (.76)	.090 (2.29)	8239
8222		8						8240
8223		10						8241
8224	12/10	6	.32 (8.1)	.73 (18.5)	.54 (13.7)	.040 (1.02)	.135 (3.4)	8242
8225		8						8243
8226		10						8244

BLOCK SPADE INSULATED

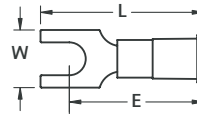

Flanged

CAT. NO.	WIRE RANGE (AWG)	FOR STUD SIZE	W	L	E	MATL THICK	BARREL .250 (6.4) LONG I.D.	MAX. INSUL. DIA.	FLANGED CAT. NO.
8227	22/18 (Red)	6	.30 (7.6)	.85 (21.6)	.70 (17.8)	.030 (.76)	.070 (1.78)	.145 (3.7)	8245
8228		8							8246
8229		10							8247
8230	16/14 (Blue)	6	.30 (7.6)	.85 (21.6)	.70 (17.8)	.030 (.76)	.090 (2.29)	.175 (4.4)	8248
8231		8							8249
8232		10							8250
8233	12/10 (Yellow)	6	.32 (8.1)	1.03 (26.2)	.84 (21.3)	.040 (1.02)	.135 (3.4)	.255 (6.5)	8251
8234		8							8252
8235		10							8253

SNAP SPADE NON-INSULATED

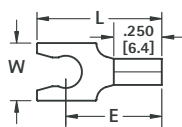

CAT. NO.	WIRE RANGE (AWG)	FOR STUD SIZE	W	L	E	MATL THICK	BARREL I.D.
8254	22/18	6	.25 (6.4)	.68 (17.3)	.50 (12.7)	.030 (.76)	.070 (1.78)
8255		8	.30 (7.6)				
8256		10	.32 (8.1)				
8257	16/14	6	.25 (6.4)	.68 (17.3)	.50 (12.7)	.030 (.76)	.090 (2.29)
8258		8	.30 (7.6)				
8259		10	.32 (8.1)				
8260	12/10	6	.28 (7.3)	.73 (18.5)	.53 (13.6)	.040 (1.02)	.135 (3.4)
8261		8	.32 (8.1)				
8262		10	.32 (8.1)				

SNAP SPADE INSULATED

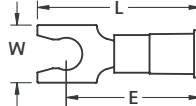
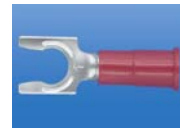

CAT. NO.	WIRE RANGE (AWG)	FOR STUD SIZE	W	L	E	MATL THICK	BARREL .250 (6.4) LONG I.D.	MAX. INSUL. DIA.
8263	22/18 (Red)	6	.25 (6.4)	.88 (22.4)	.70 (17.8)	.030 (.76)	.070 (1.78)	.145 (3.7)
8264		8	.30 (7.6)					
8265		10	.32 (8.1)					
8266	16/14 (Blue)	6	.25 (6.4)	.88 (22.4)	.70 (17.8)	.030 (.76)	.090 (2.29)	.170 (4.3)
8267		8	.30 (7.6)					
8268		10	.32 (8.1)					
8269	12/10 (Yellow)	6	.28 (7.3)	1.03 (26.2)	.83 (21.2)	.040 (1.02)	.135 (3.4)	.250 (6.4)
8270		8	.32 (8.1)					
8271		10	.32 (8.1)					

HAND CRIMP TOOL

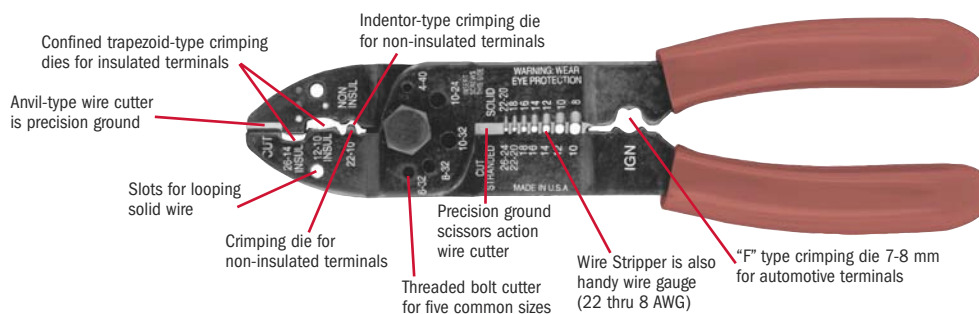

CAT. NO. 1345

Tel (718) 956-8900 • Fax (718) 956-9040
(800) 221-5510 • kec@keylco.com

KEYSTONE
RoHS COMPLIANT ~ ISO 9001 CERTIFIED

www.keylco.com
31-07 20th Road - Astoria, NY 11105-2017

SOLDERLESS TERMINALS



PC TERMINAL LUGS

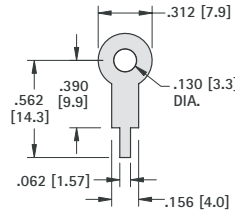

MATERIAL: .016 (.40) Brass, Tin Plate

CAT. NO. 680

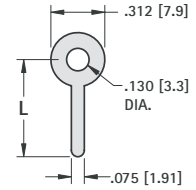

MATERIAL: .020 (.51) Brass, Tin Plate

CAT. NO.	L
4000	.500 (12.7)
4001	.562 (14.3)
4002	.750 (19.1)
4003	1.000 (25.4)

LOCKWASHER TERMINAL LUGS

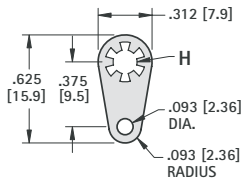

MATERIAL: .018 (.46) Brass, Tin Plate

CAT. NO.	H	STUD SIZE
908	.120 (3.1)	#4
914	.140 (3.6)	#6
915	.171 (4.4)	#8

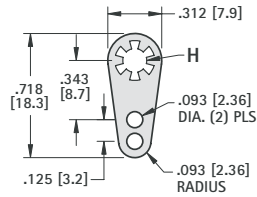

MATERIAL: .018 (.46) Brass, Tin Plate

CAT. NO.	H	STUD SIZE
910	.120 (3.1)	#4
918	.140 (3.6)	#6
906	.171 (4.4)	#8

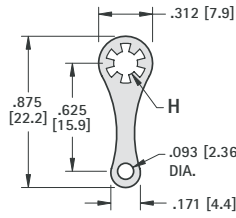

MATERIAL: .018 (.46) Brass, Tin Plate

CAT. NO.	H	STUD SIZE
903	.120 (3.1)	#4
904	.140 (3.6)	#6
905	.171 (4.4)	#8
913	.196 (5.0)	#10

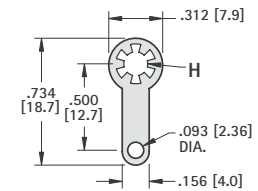

MATERIAL: .018 (.46) Brass, Tin Plate

CAT. NO.	H	STUD SIZE
909	.120 (3.1)	#4
916	.140 (3.6)	#6
917	.171 (4.4)	#8

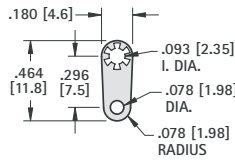

MATERIAL: .013 (.33) Brass, Tin Plate

CAT. NO. 907

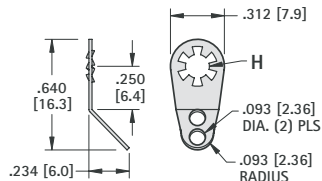

MATERIAL: .018 (.46) Brass, Tin Plate

CAT. NO.	H	STUD SIZE
7311	.120 (3.1)	#4
7312	.140 (3.6)	#6
7313	.171 (4.4)	#8

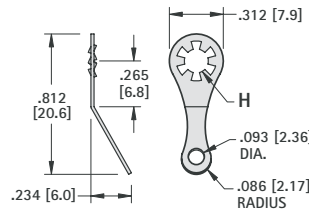

MATERIAL: .018 (.46) Brass, Tin Plate

CAT. NO.	H	STUD SIZE
7317	.120 (3.1)	#4
7318	.140 (3.6)	#6
7319	.171 (4.4)	#8
4704	.196 (5.0)	#10

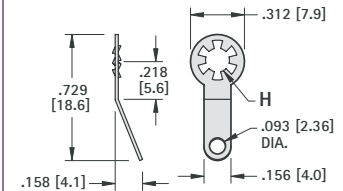

MATERIAL: .018 (.46) Brass, Tin Plate

CAT. NO.	H	STUD SIZE
7314	.120 (3.1)	#4
7315	.140 (3.6)	#6
7316	.171 (4.4)	#8

SOLDER TERMINAL LUGS

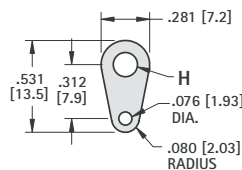

MATERIAL: .015 (.38) Brass, Tin Plate

CAT. NO.	H	STUD SIZE
7328	.120 (3.1)	#4
7329	.140 (3.6)	#6
7330	.171 (4.4)	#8

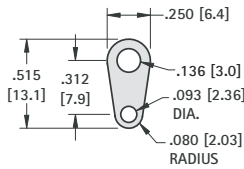

MATERIAL: .016 (.41) Brass, Tin Plate

CAT. NO. 4004

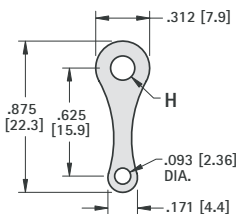

MATERIAL: .020 (.51) Brass, Tin Plate

CAT. NO.	H	STUD SIZE
7331	.120 (3.1)	#4
7332	.140 (3.6)	#6
7333	.171 (4.4)	#8

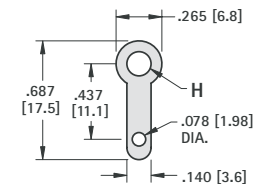

MATERIAL: .020 (.51) Brass, Tin Plate

CAT. NO.	H	STUD SIZE
7325	.120 (3.1)	#4
7326	.140 (3.6)	#6
7327	.171 (4.4)	#8
7340	.196 (5.0)	#10

PC TEST POINTS - SLOTTED & LOOP TYPES

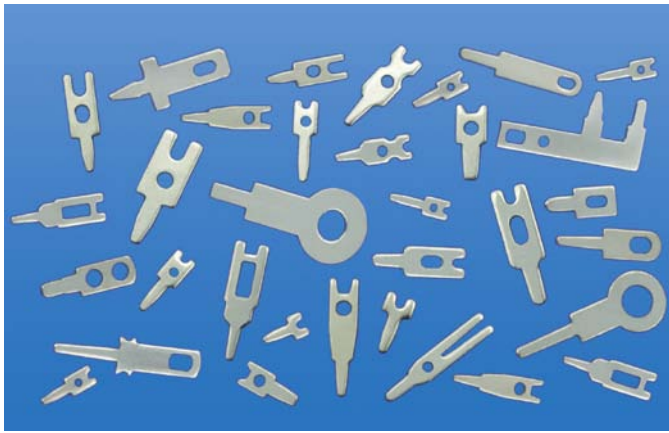

- Low profile, space saving designs for dense packaging
- Wide variety of configurations to suit most applications
- Safe, practical, economical replacement for wire-wrap posts
- Easy mount design, ideal for wave soldering
- Re-fit PC boards without need for re-design
- Provides easy access for production testing and field service troubleshooting
- Positive grip when using J hooks, EZ hooks, grabbers, clips, tips and probes
- Custom test point terminals can be manufactured to your specifications
- Other platings and materials available upon request

MATERIAL: Brass, Tin Plate

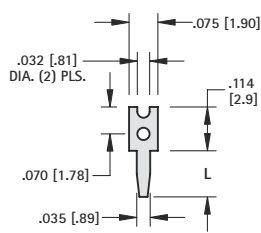

MATERIAL: .025 (.64) Brass

CAT. NO.	L
1030	.120 (3.0)
1031	.156 (4.0)

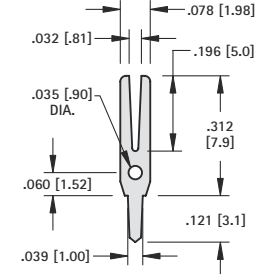

MATERIAL: .016 (.41) Brass

CAT. NO. 1037

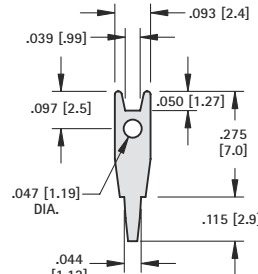

MATERIAL: .025 (.64) Brass

CAT. NO. 1036

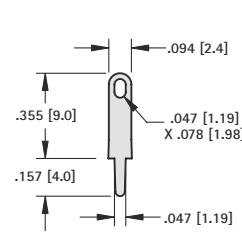

MATERIAL: .020 (.51) Brass

CAT. NO. 4953

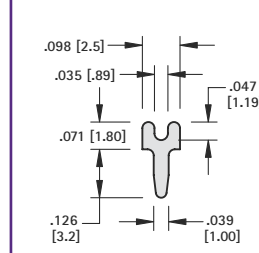

MATERIAL: .025 (.64) Brass

CAT. NO. 4950

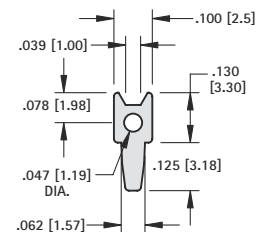

MATERIAL: .024 (.64) Brass

CAT. NO. 1032

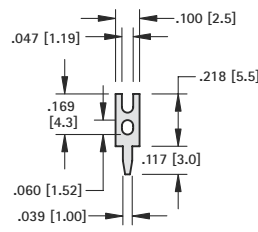

MATERIAL: .020 (.51) Brass

CAT. NO. 1035

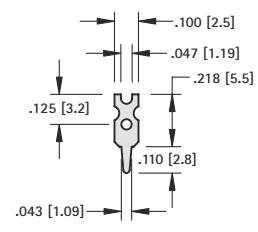

MATERIAL: .025 (.64) Brass

CAT. NO. 1034

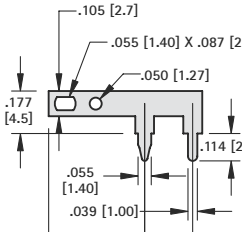

MATERIAL: .025 (.64) Brass

CAT. NO. 1045

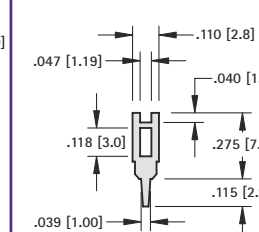

MATERIAL: .025 (.64) Brass

CAT. NO. 1040

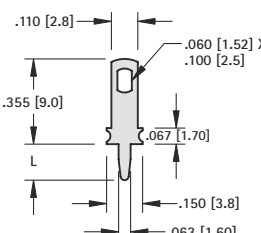

MATERIAL: .032 (.81) Brass

CAT. NO.	L
1041	.275 (7.0)
1046	.150 (3.8)

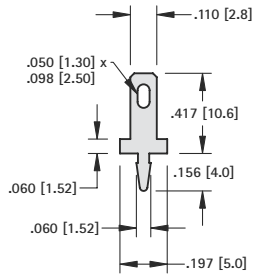

MATERIAL: .020 (.51) Brass

CAT. NO. 1250

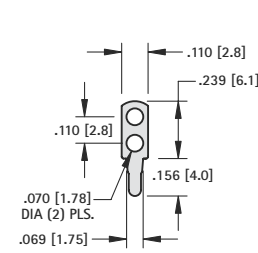

MATERIAL: .020 (.51) Brass

CAT. NO. 1038

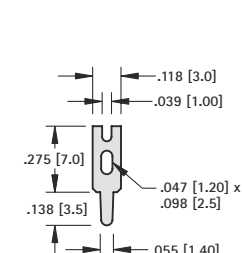

MATERIAL: .025 (.64) Brass

CAT. NO. 4951

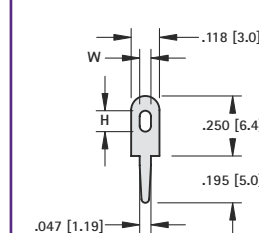

MATERIAL: .025 (.64) Brass

CAT. NO.	W	H
1249	.047 (1.20)	.087 (2.21)
4952	.063 (1.60)	.098 (2.50)

CUSTOM TERMINALS

Custom terminals can be machined to your exact specifications. Standard and special terminals can be staked onto special boards. Please email/fax your design to our Engineering Department.

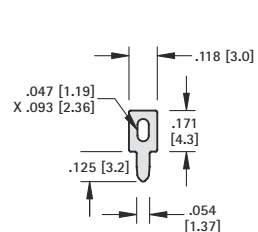

MATERIAL: .025 (.64) Brass

CAT. NO. 1033

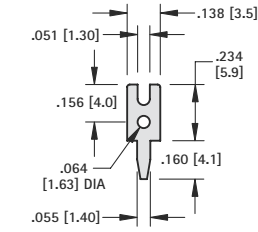

MATERIAL: .025 (.64) Brass

CAT. NO. 1039

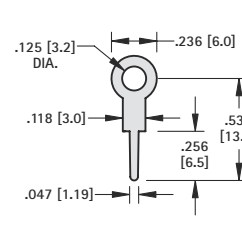

MATERIAL: .020 (.51) Brass

CAT. NO. 4954

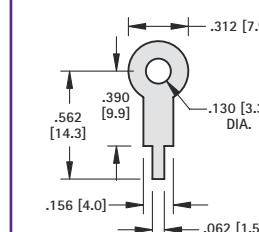

MATERIAL: .015 (.38) Brass

CAT. NO. 680

(THM) THRU HOLE MOUNT TEST POINTS - COLOR KEYED

- Color keyed for visibility and quick identification
- Economical choice for PC test point terminations
- Snap-fit mounting provides positive retention for wave soldering
- Wire form loop for safe, non-slip testing
- Space saving, ultra low and low profile designs
- High profile design for difficult to reach applications
- Suitable for high density packaging on .062 (1.57) and .093 (2.36) PC boards
- Practical replacement for wire-wrap posts and turrets
- Secure grip for J hooks, EZ hooks, grabbers, alligator clips, tips or probes
- High temperature nylon base ideal for reflow soldering
- Ideal for reliable production testing and field service troubleshooting



COLOR KEYED

MINIATURE

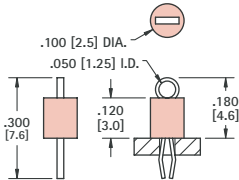

SPECIFICATIONS

Terminal:

.010 (.25) x .020 (.51) Phosphor Bronze, Silver Plate

Base: Nylon 46, UL Rated 94V-0

Mtg. Hole: .040 (1.0) Diameter

CAT. NO.	BASE COLOR	CAT. NO.	BASE COLOR
5000	RED	5115	BROWN
5001	BLACK	5116	GREEN
5002	WHITE	5117	BLUE
5003	ORANGE	5118	GREY
5004	YELLOW	5119	PURPLE

COMPACT

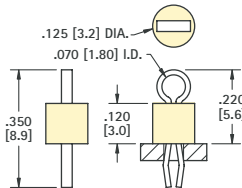

SPECIFICATIONS

Terminal:

.015 (.38) x .032 (.81) Phosphor Bronze, Silver Plate

Base: Nylon 46, UL Rated 94V-0

Mtg. Hole: .063 (1.6) Diameter

CAT. NO.	BASE COLOR	CAT. NO.	BASE COLOR
5005	RED	5120	BROWN
5006	BLACK	5121	GREEN
5007	WHITE	5122	BLUE
5008	ORANGE	5123	GREY
5009	YELLOW	5124	PURPLE

MULTIPURPOSE

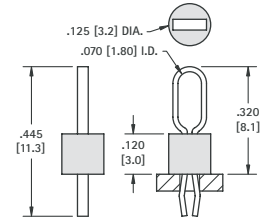

SPECIFICATIONS

Terminal:

.015 (.38) x .032 (.81) Phosphor Bronze, Silver Plate

Base: Nylon 46, UL Rated 94V-0

Mtg. Hole: .063 (1.6) Diameter

CAT. NO.	BASE COLOR	CAT. NO.	BASE COLOR
5010	RED	5125	BROWN
5011	BLACK	5126	GREEN
5012	WHITE	5127	BLUE
5013	ORANGE	5128	GREY
5014	YELLOW	5129	PURPLE

ULTRA LOW PROFILE

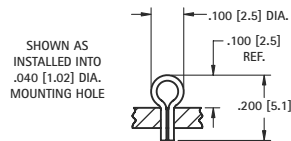

MATERIAL: .017 (.43) Dia. Phosphor Bronze Silver plate
Mtg Hole: .040 (1.0)

CAT. NO. 5021

LOW PROFILE

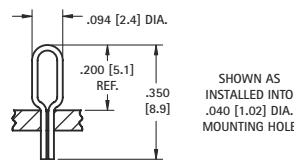

MATERIAL: .016 (.40) x .028 (.71) Phosphor Bronze Silver plate
Mtg Hole: .040 (1.0)

CAT. NO. 5020

STANDARD

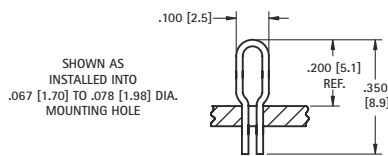

MATERIAL: .020 (.50) Dia. Phosphor Bronze Silver plate
Mtg Hole: .073 (1.85)

CAT. NO. 5023

LARGE

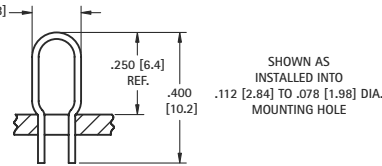

MATERIAL: .020 (.50) Dia. Phosphor Bronze Silver plate
Mtg Hole: .114 (2.9)

CAT. NO. 5024

JUMPERS

.100 SPACING

Mounting Detail

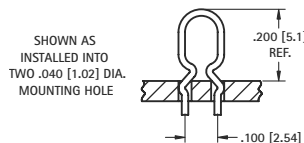
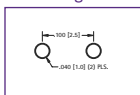

MATERIAL: .020 (.50) Dia. Phosphor Bronze Silver plate
Mtg Hole: .040 (1.0)

CAT. NO. 5025

.200 SPACING

Mounting Detail

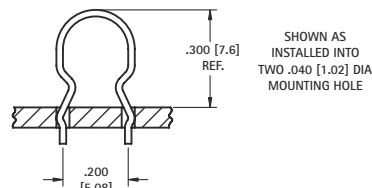
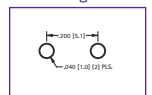

MATERIAL: .016 (.40) x .028 (.71) Phosphor Bronze Silver plate
Mtg Hole: .040 (1.0)

CAT. NO. 5026

(SMT) SURFACE MOUNT TEST POINTS ON TAPE & REEL

MICRO MINIATURE

SUPPLIED ON TAPE AND REEL

- Manufactured using flat wire to provide a large mounting surface area
- Ideal for use with miniature probes, clips, and hooks
- Efficient, safe, board level testing
- Ultra low profile, ideally suited for advanced surface mount printed circuit board applications
- Designed for long life and durability

SPECIFICATIONS

Contact Material:

.010 (.25) Phosphor Bronze

Contact Finish: Silver Plate

Tape Material: 8mm wide; 4mm pitch; conductive polycarbonate carrier tape meets ANSI/EIA-481 standard

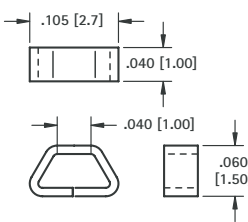

Pad Layout

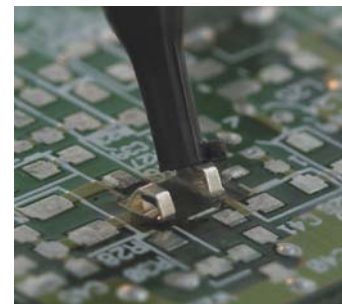
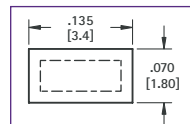

CAT. NO. 5015 - 1000 pieces per reel

CAT. NO. 5017 - 5000 pieces per reel

MINIATURE

SUPPLIED ON TAPE AND REEL

- Ideal for use with most standard probes, clips and hooks
- Efficient, safe, board level testing
- Unique design provides exceptional strength and durability
- Simplifies testing on dense SMT circuit boards

SPECIFICATIONS

Contact Material:

.015 (.38) Phosphor Bronze

Contact Finish: Silver Plate

Tape Material: 12mm wide; 4mm pitch; conductive polycarbonate carrier tape meets ANSI/EIA-481 standard

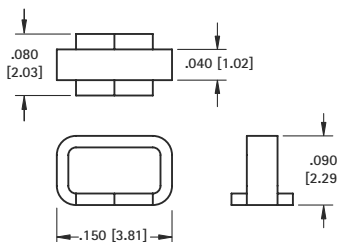

Pad Layout

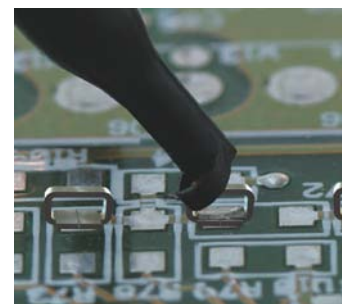
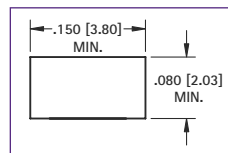

CAT. NO. 5019 - 1000 pieces per reel

CAT. NO. 5029 - 5000 pieces per reel

COMPACT

SUPPLIED ON TAPE AND REEL

- Ideal for use with standard probes, clips and hooks
- Efficient, safe, board level testing
- Unique design provides exceptional strength and durability
- Simplifies testing on dense SMT circuit boards

SPECIFICATIONS

Contact Material:

.015 (.38) Phosphor Bronze

Contact Finish: Silver Plate

Tape Material: 12mm wide; 4mm pitch; conductive polycarbonate carrier tape meets ANSI/EIA-481 standard

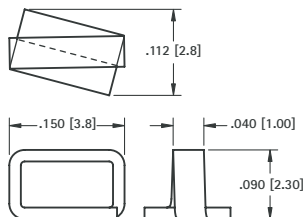

Pad Layout

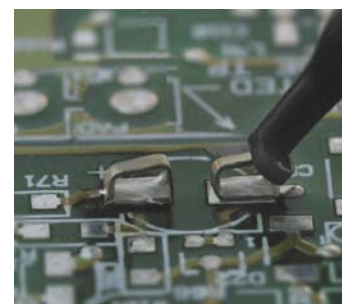
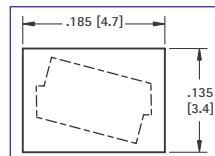

CAT. NO. 5016 - 1000 pieces per reel

CAT. NO. 5018 - 5000 pieces per reel

ALLIGATOR CLIPS

SMALL CLIP

- Solder Connection with Strain Relief
- Insulated or Non-Insulated



CAT. NO.	INSULATOR COLOR
5033	NONE
5034	RED
5035	BLACK
5036	GREEN
5037	YELLOW

JAW SPREAD
.236 (6.0) max.

MATERIAL:
Clip: Steel, Nickel Plate
Insulator: Vinyl

MEDIUM CLIP

- Solder Connection with Strain Relief
- Insulated or Non-Insulated



CAT. NO.	INSULATOR COLOR
5038	NONE
5039	RED
5040	BLACK

JAW SPREAD
.236 (6.0) max.

MATERIAL:
Clip: Steel, Nickel Plate
Insulator: Vinyl

LARGE CLIP

- Solder Connection or Screw Connection (Barrel Accepts Wire or Standard Banana Plugs)
- Insulated or Non-Insulated



CAT. NO.	INSULATOR COLOR
5044	NONE
5045	RED
5046	BLACK
5048	SCREW INSTALLED

JAW SPREAD
.315 (8.0) max.

MATERIAL:
Clip: Steel, Nickel Plate
Insulator: Vinyl

PC SCREW TERMINALS

These easy-to-mount, multipurpose screw type terminals are a practical, low-cost alternative to PC screw type edge connectors, barrier blocks, terminal boards and terminal strips. Steadfast and easy to install, will accommodate solid or stranded wire, crimp type terminals or lugs. Multi-placement of these low-profile terminals make them ideally suited for high density packaging. Supplied unassembled or with screw installed and captivated.

PRINCIPAL FEATURES

- Low profile
- Stable, no-rock design with exclusive anti-rotational feature
- Easily mounts with four legs into pre-drilled or punched holes
- Accepts 14-22 AWG solid or stranded wire, crimp type terminals or lugs
- Ideally suited for high-density packaging
- Available in horizontal or vertical mounting
- Space-saving and time saving
- Easy accessibility for PC board testing
- Binding screw is positioned above board level to avoid wicking during wave soldering
- Terminals are made of Brass with Tin Plate
- Supplied with a combination drive 6-32 binding head screw

CAT. NO. COLOR SUFFIX
Ex: XXXX -X

COLOR SELECTION:
Select desired screw terminal and add color suffix to the screw terminal Cat. No.

HEAD COLOR	SUFFIX
RED	-2
BLACK	-3
WHITE	-4
BLUE	-5
GREEN	-6
YELLOW	-7
NICKEL	none

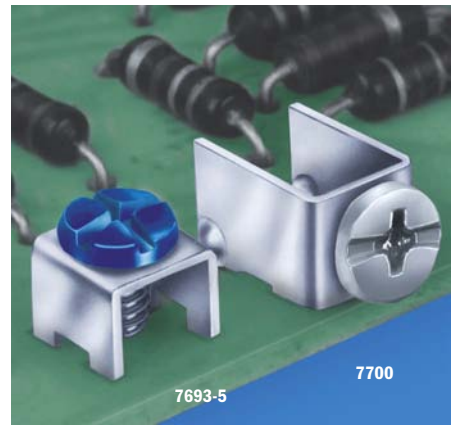

SCREW TERMINALS



SNAP-IN PC MOUNT

- Color coded screws available (add color screw suffix to Cat. No.)

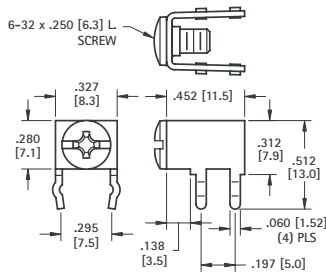

HORIZONTAL TYPE

SPECIFICATIONS

Rated: 15 Amps
Terminal: .032 (.81) Brass, Matte Tin Plate
Binding Head Screw: Brass, Nickel Screw

Mounting Detail

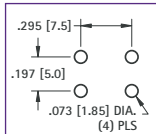

Color coded screws available (add color screw suffix to Cat. No.)

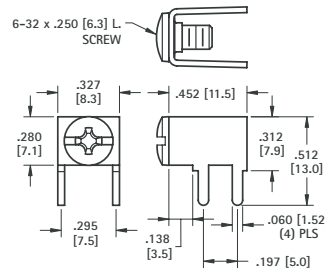

PC MOUNT

- Color coded screws available (add color screw suffix to Cat. No.)

CAT. NO. 7779 (No Screw Supplied)

CAT. NO. 7690 (Screw Supplied Unassembled)

CAT. NO. 7692 (Screw Installed & Captivated)

CAT. NO. 7781 (No Screw Supplied)

CAT. NO. 8190 (Screw Supplied Unassembled)

CAT. NO. 7700 (Screw Installed & Captivated)



SNAP-IN PC MOUNT

CAT. NO. 7774 (No Screw Supplied)

CAT. NO. 7773 (Screw Supplied Unassembled)

MINI

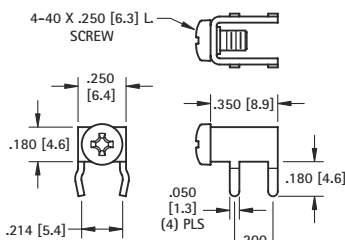

Mounting Detail

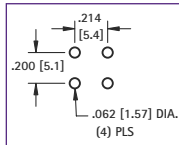

SPECIFICATIONS

Rated: 15 Amps
Terminal: .032 (.81) Brass, Matte Tin Plate
Binding Head Screw: Brass, Nickel Screw

45°

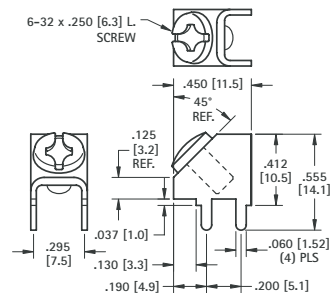

PC MOUNT

- Color coded screws available (add color screw suffix to Cat. No.)

Mounting Detail

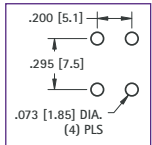

CAT. NO. 7783 (No Screw Supplied)

CAT. NO. 8189 (Screw Supplied Unassembled)

CAT. NO. 7702 (Screw Installed & Captivated)



SNAP-IN PC MOUNT

- Color coded screws available (add color screw suffix to Cat. No.)

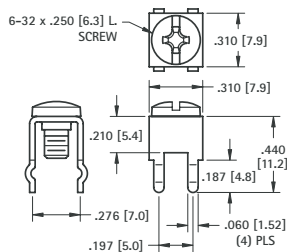

VERTICAL TYPE

SPECIFICATIONS

Rated: 15 Amps
Terminal: .032 (.81) Brass, Matte Tin Plate
Binding Head Screw: Brass, Nickel Screw

Mounting Detail

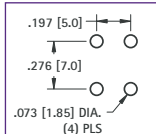

Color coded screws available (add color screw suffix to Cat. No.)

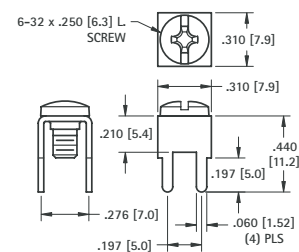

PC MOUNT

- Color coded screws available (add color screw suffix to Cat. No.)

CAT. NO. 7782 (No Screw Supplied)

CAT. NO. 8191 (Screw Supplied Unassembled)

CAT. NO. 7701 (Screw Installed & Captivated)

PC SCREW TERMINALS

LOW PROFILE VERTICAL TYPE



7778-7

- Color coded screws available (add color screw suffix to Cat. No.)

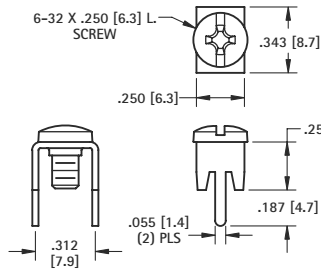

SPECIFICATIONS

Rated: 15 Amps
Terminal: .032 (.81) Brass, Matte Tin Plate
Binding Head Screw: Brass, Nickel Plate

Mounting Detail

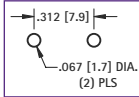

CAT. NO. 7784 (No Screw Supplied)

CAT. NO. 8198 (Screw Supplied Unassembled)

CAT. NO. 7778 (Screw Installed & Captivated)



7775-2

- Color coded screws available (add color screw suffix to Cat. No.)

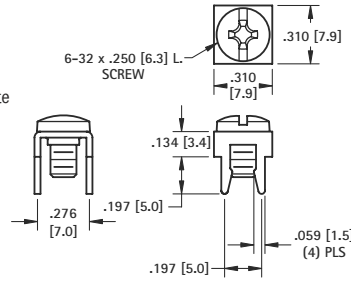

CAT. NO. 7785 (No Screw Supplied)

CAT. NO. 8195 (Screw Supplied Unassembled)

CAT. NO. 7775 (Screw Installed & Captivated)

Mounting Detail

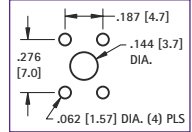

VERTICAL TYPE



7699-6

PC MOUNT

- Color coded screws available (add color screw suffix to Cat. No.)

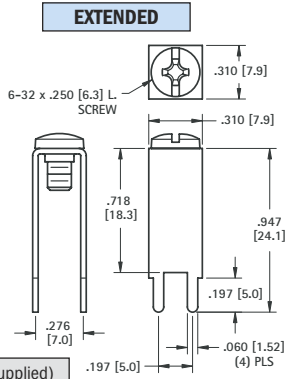

SPECIFICATIONS

Rated: 15 Amps
Terminal: .032 (.81) Brass, Matte Tin Plate
Binding Head Screw: Brass, Nickel Plate

Mounting Detail

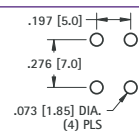

CAT. NO. 7789 (No Screw Supplied)

CAT. NO. 7697 (Screw Supplied Unassembled)

CAT. NO. 7699 (Screw Installed & Captivated)

HEAVY DUTY

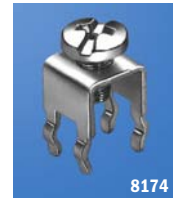

8174

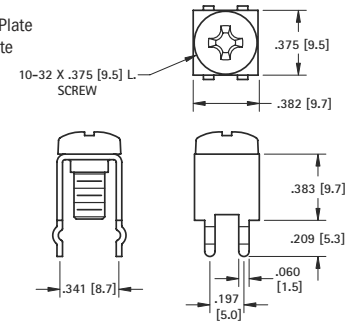

CAT. NO. 7791 (No Screw Supplied)

CAT. NO. 8174 (Screw Supplied Unassembled)

Mounting Detail

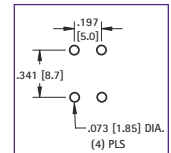

30 AMP - VERTICAL



8199-6

- Combination drive, binding head screw
- Color coded screws available (add color screw suffix to Cat. No.)

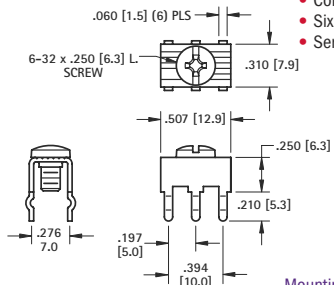

PRINCIPAL FEATURES

- Compact, heavy duty design
- Six snap-in legs for total stability
- Serrated top surface secures connection

Mounting Detail

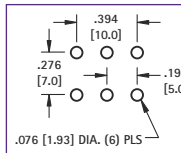

SPECIFICATIONS

Rated: 30 Amps
Terminal: .032 (.81) Brass, Matte Tin Plate
Binding Head Screw: Brass, Nickel Plate

CAT. NO. 7786 (No Screw Supplied)

CAT. NO. 8197 (Screw Supplied Unassembled)

CAT. NO. 8199 (Screw Installed & Captivated)

HEAVY DUTY



8196

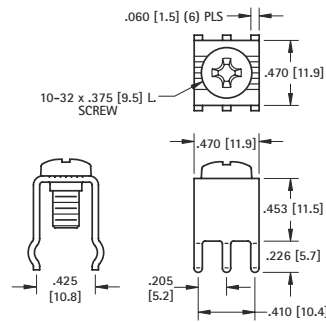

SPECIFICATIONS

Rated: 30 Amps
Terminal: .045 (1.14) Brass, Matte Tin Plate
Screw: Stainless Steel

CAT. NO. 7787 (No Screw Supplied)

CAT. NO. 8196 (Screw Supplied Unassembled)

Mounting Detail

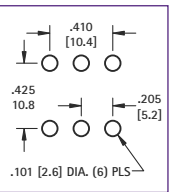

COLOR CODED SCREW TERMINAL SELECTION GUIDE

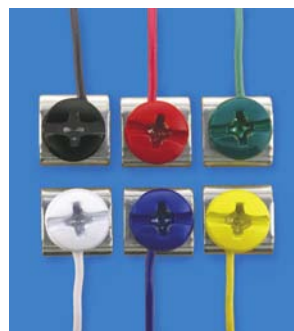

Color Coded Screw Terminals provide:

- Quick identification
- Visibility for field service troubleshooting

SPECIFICATIONS

Combination Binding Head:

Standard screw is Brass, Nickel Plate. For painted, color head, add suffix as shown.



COLOR SELECTION:

Select desired screw terminal and add color suffix to the screw terminal Cat. No.

HEAD COLOR	SUFFIX
RED	-2
BLACK	-3
WHITE	-4
BLUE	-5
GREEN	-6
YELLOW	-7
NICKEL	none

CAT. NO. COLOR SUFFIX
Ex: XXXX -X



Refer to page 133 for color screws only

SEMS SCREW TERMINALS

15 AMP



**SNAP-IN
PC MOUNT**

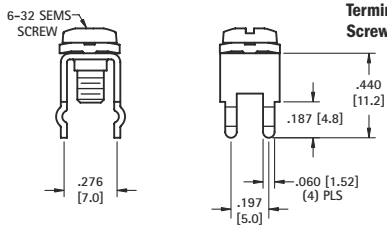

SPECIFICATIONS

Terminal: .032 (.81) Brass, Matte Tin Plate
Screw & Washer: Steel, Nickel Plate

CAT. NO. 7691-SEMS (Screw Supplied Unassembled)
CAT. NO. 7693-SEMS (Screw Installed & Captivated)



PC MOUNT

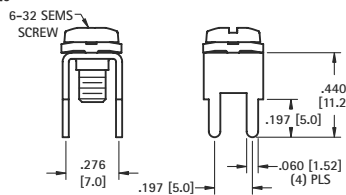

CAT. NO. 8191-SEMS (Screw Supplied Unassembled)
CAT. NO. 7701-SEMS (Screw Installed & Captivated)



**SNAP-IN
PC MOUNT**

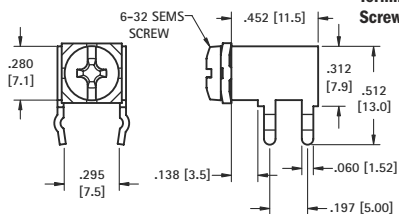

SPECIFICATIONS

Terminal: .032 (.81) Brass, Matte Tin Plate
Screw & Washer: Steel, Nickel Plate

CAT. NO. 7690-SEMS (Screw Supplied Unassembled)
CAT. NO. 7692-SEMS (Screw Installed & Captivated)



PC MOUNT

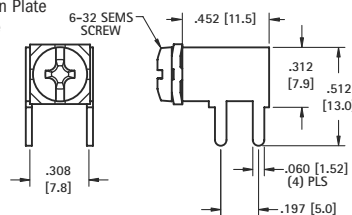

CAT. NO. 8190-SEMS (Screw Supplied Unassembled)
CAT. NO. 7700-SEMS (Screw Installed & Captivated)



**SNAP-IN
PC MOUNT**

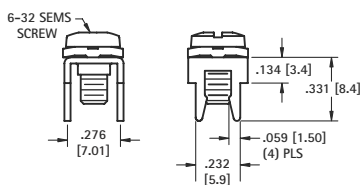

SPECIFICATIONS

Terminal: .032 (.81) Brass, Matte Tin Plate
Screw & Washer: Steel, Nickel Plate

CAT. NO. 8195-SEMS (Screw Supplied Unassembled)
CAT. NO. 7775-SEMS (Screw Installed & Captivated)



PC MOUNT

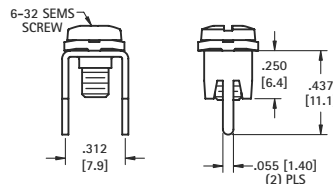

CAT. NO. 8198-SEMS (Screw Supplied Unassembled)
CAT. NO. 7778-SEMS (Screw Installed & Captivated)



PC MOUNT

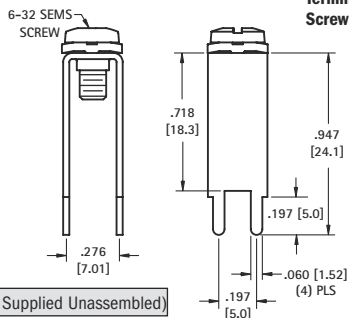

SPECIFICATIONS

Terminal: .032 (.81) Brass, Matte Tin Plate
Screw & Washer: Steel, Nickel Plate

CAT. NO. 7697-SEMS (Screw Supplied Unassembled)
CAT. NO. 7699-SEMS (Screw Installed & Captivated)



PC MOUNT

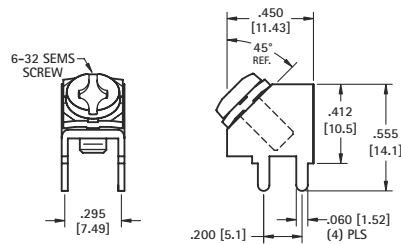

CAT. NO. 8189-SEMS (Screw Supplied Unassembled)
CAT. NO. 7702-SEMS (Screw Installed & Captivated)



**SNAP-IN
PC MOUNT**

30 AMP

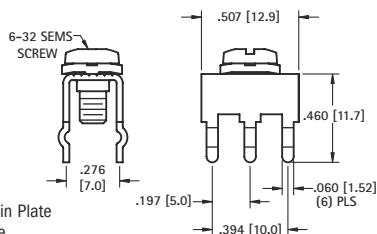

SPECIFICATIONS

Terminal: .032 (.81) Brass, Matte Tin Plate
Screw & Washer: Steel, Nickel Plate

CAT. NO. 8197-SEMS (Screw Supplied Unassembled)
CAT. NO. 8199-SEMS (Screw Installed & Captivated)

SEMS Screw Terminals provide quick and secure attachment of wire leads. SEMS screw has captivated, free spinning lock washer, eliminated twisting of wire when tightening lead to terminal. Washer will rise with head of screw when unscrewed.

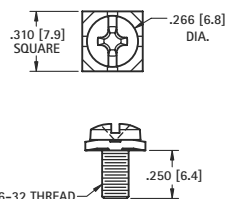

SPECIFICATIONS

Screw & Washer: Steel, Nickel Plate

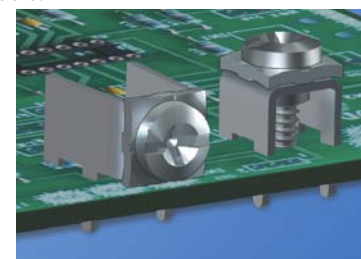

CAT. NO. 9920 (SEMS Screw Only)

SEMS SCREW TERMINALS

METRIC PC SCREW TERMINALS

These easy-to-mount, multipurpose screw type terminals are a practical, low-cost alternative to PC screw type edge connectors, barrier blocks, terminal boards and terminal strips. Steadfast and easy to install, will accommodate solid or stranded wire, crimp type terminals or lugs.

Multi- placement of these low-profile terminals make them ideally suited for high density packaging. Supplied unassembled or with screw installed and captivated.

PRINCIPAL FEATURES

- Stable, no-rock design with exclusive anti-rotational feature
- Easily mounts with four legs into pre-drilled or punched holes
- Accepts 14-22 AWG solid or stranded wire, crimp type terminals or lugs
- Ideally suited for high-density packaging
- Easy accessibility for PC board testing
- Binding screw is positioned above board level to avoid wicking during wave soldering

HEAD COLOR	SUFFIX
RED	-2
BLACK	-3
WHITE	-4
BLUE	-5
GREEN	-6
YELLOW	-7
NICKEL	none

COLOR SELECTION:
Select desired screw terminal and add color suffix to the screw terminal Cat. No.

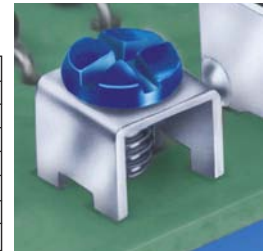

Refer to page 133 for color screws only

HORIZONTAL TYPE



SNAP-IN PC MOUNT

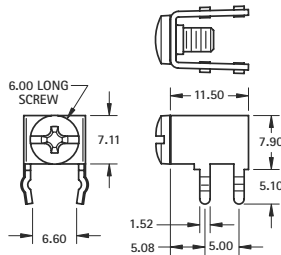

SPECIFICATIONS

Rated: 15 Amps
Terminal: .80 Brass, Matte Tin Plate
Screw: Brass, Nickel Plate

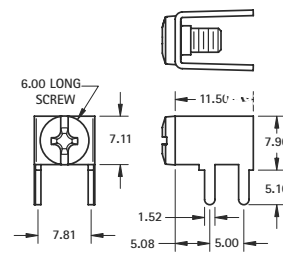

PC MOUNT

M3 THREAD		M4 THREAD	
CAT. NO.		CAT. NO.	
7790	No Screw Supplied	7792	
7689*	Screw Supplied Unassembled	7793	
7695*	Screw Installed & Captivated	7794	

*Available with color Coded Screws

Mounting Detail

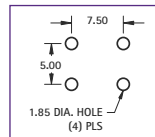

Color coded screws available (add color screw suffix to Cat. No.)

M3 THREAD		M4 THREAD	
CAT. NO.		CAT. NO.	
7760	No Screw Supplied	7764	
7761*	Screw Supplied Unassembled	7765	
7762*	Screw Installed & Captivated	7766	

*Available with color Coded Screws

VERTICAL TYPE



SNAP-IN PC MOUNT

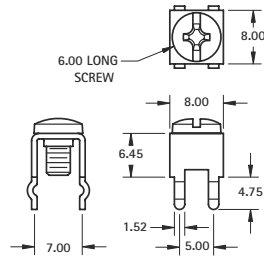

SPECIFICATIONS

Rated: 15 Amps
Terminal: .80 Brass, Matte Tin Plate
Screw: Brass, Nickel Plate

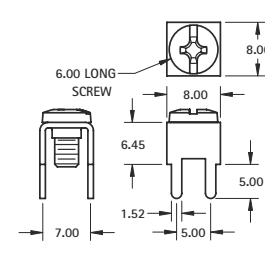

PC MOUNT

M3 THREAD		M4 THREAD	
CAT. NO.		CAT. NO.	
7788	No Screw Supplied	7795	
7698*	Screw Supplied Unassembled	7796	
7696*	Screw Installed & Captivated	7797	

*Available with color Coded Screws

Mounting Detail

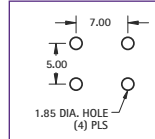

Color coded screws available (add color screw suffix to Cat. No.)

M3 THREAD		M4 THREAD	
CAT. NO.		CAT. NO.	
7770	No Screw Supplied	7767	
7771*	Screw Supplied Unassembled	7768	
7772*	Screw Installed & Captivated	7769	

*Available with color Coded Screws

30 AMP - VERTICAL TYPE



SNAP-IN PC MOUNT

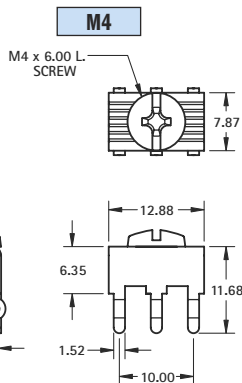

SPECIFICATIONS

Rated: 30 Amps
Terminal: .80 Brass, Matte Tin Plate
Screw: Brass, Nickel Plate

CAT. NO.	
7798	No Screw Supplied
7799	Screw Supplied Unassembled
7800	Screw Installed & Captivated

Color coded screws available (add color screw suffix to Cat. No.)

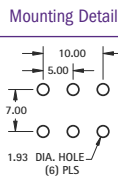

PRINCIPAL FEATURES

- Compact, heavy duty design
- Six snap-in legs for total stability
- Serrated top surface secures connection

M5

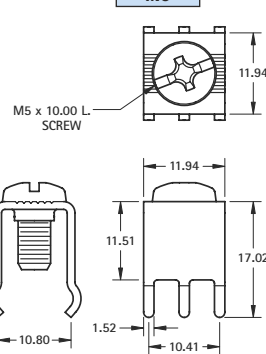

SPECIFICATIONS

Rated: 30 Amps
Terminal: 1.14 Brass, Matte Tin Plate
Screw: Brass, Nickel Plate

CAT. NO.	
7807	No Screw Supplied
7808	Screw Supplied Unassembled



SNAP-IN PC MOUNT

Mounting Detail

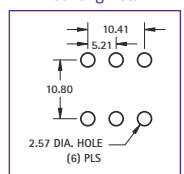

MINI BINDING POSTS



THRU HOLE

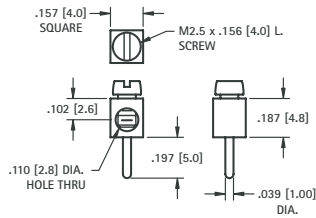

SPECIFICATIONS

Terminal: Brass, Tin Plate
Screw: Steel, Zinc Plate
Mounting Hole: .047 (1.2)
Current Rating: 15 AMP

CAT. NO. 8730 (Screw Installed)

WIRE CONTACT

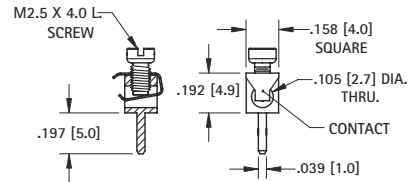

SPECIFICATIONS

Terminal: Brass, Tin Plate
Screw: Steel, Zinc Plate
Contact: Phosphorus Bronze, Tin Plate
Mounting Hole: .047 (1.2)
Current Rating: 15 AMP

CAT. NO. 8737 (Screw Installed)

LOW PROFILE SCREW TERMINALS

These sturdy, low cost screw terminals, feature an anti-rotation tab for use with spade terminals. They are available with the screw installed and captivated, the screw unassembled or without a screw.



6-32

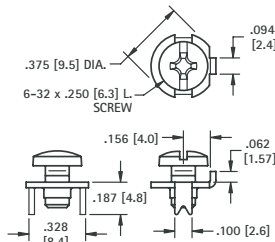

PRINCIPLE FEATURES

- Easy to connect using solid or stranded wire, crimp lugs or terminals
- Anti-rotation tab for use with spade terminals
- Supplied with screw installed and captivated, with screw unassembled, or without screw
- Stainless steel screw will not wick

SPECIFICATIONS

Rated: 15 Amps
Terminal: .032 (.81) Brass, Matte Tin Plate
Screw: Combination drive, Stainless Steel

CAT. NO. 1284 (No Screw Supplied)

CAT. NO. 1298 (Screw Supplied Unassembled)

CAT. NO. 1201 (Screw Installed & Captivated)

Mounting Detail

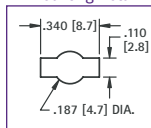

8-32

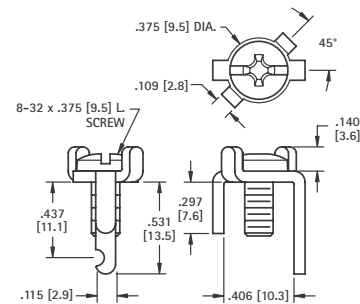

SPECIFICATIONS

Rated: 15 Amps
Terminal: .064 (1.6) Brass, Matte Tin Plate
Screw: Brass, Nickel Plate

CAT. NO. 1205 (No Screw Supplied)

CAT. NO. 1207 (Screw Supplied Unassembled)

CAT. NO. 1209 (Screw Installed)

Mounting Detail

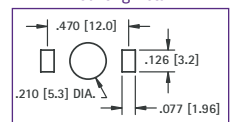

HEAVY DUTY SCREW TERMINALS - 30 AMP

These heavy duty terminals are available with the screw installed or unassembled, and feature easy access to connect solid or stranded wire, crimp type lugs or terminals.



10-32

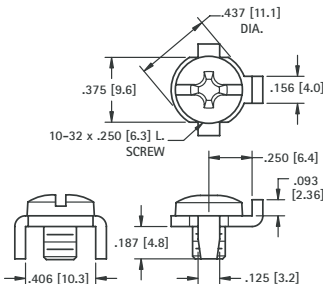

PRINCIPLE FEATURES

- Anti-rotation tab for use with spade terminals
- Below the board notched leg, to facilitate mechanical and solder connections
- Easy to connect using solid or stranded wire, crimp lugs or terminals
- Available with screw installed, unassembled, or without screw

SPECIFICATIONS

Rated: 30 Amps
Terminal: .062 (1.6) Brass, Matte Tin Plate
Screw: Combination drive, Stainless Steel

CAT. NO. 1293 (No Screw Supplied)

CAT. NO. 1299 (Screw Supplied Unassembled)

CAT. NO. 1202 (Screw Installed & Captivated)

Mounting Detail

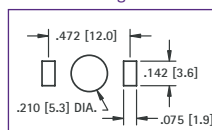

10-32

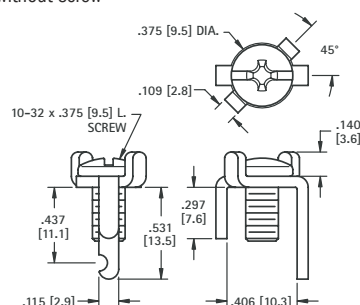

SPECIFICATIONS

Rated: 30 Amps
Terminal: .064 (1.6) Brass, Matte Tin Plate
Screw: Steel, Nickel Plate

CAT. NO. 1206 (No Screw Supplied)

CAT. NO. 1208 (Screw Supplied Unassembled)

CAT. NO. 1283 (Screw Installed)

Mounting Detail

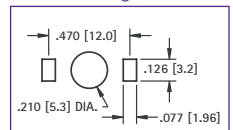

SCREW TERMINALS



OFFSET LEG

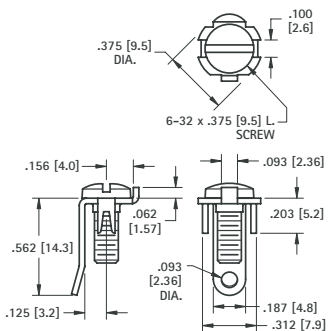

SPECIFICATIONS

Terminal: .032 (.81) Steel, Tin Plate
Screw: Steel, Nickel Plate
 (Screw Installed & Captivated)
Rated: 15 Amps

CAT. NO. 1248

STRAIGHT LEG

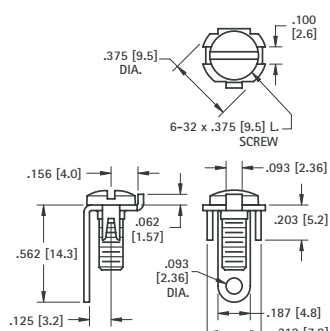

SPECIFICATIONS

Terminal: .032 (.81) Steel, Tin Plate
Screw: Steel, Nickel Plate
 (Screw Installed & Captivated)
Rated: 15 Amps

CAT. NO. 1215



SOLDER TAB

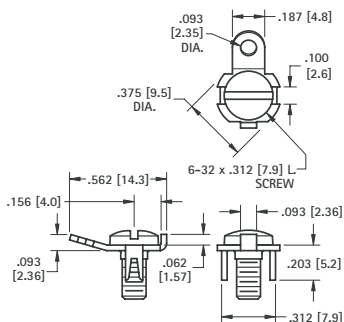

SPECIFICATIONS

Terminal: .032 (.81) Steel, Tin Plate
Screw: Steel, Nickel Plate
 (Screw Installed & Captivated)
Rated: 15 Amps

CAT. NO. 1232

QUICK FIT

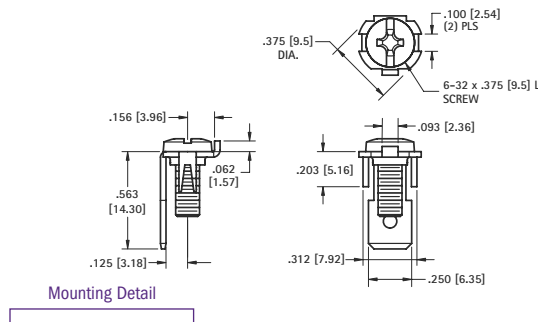

SPECIFICATIONS

Terminal: .032 (.81) Brass, Tin Plate
Screw: Steel, Nickel Plate
 (Screw Installed & Captivated)
Rated: 15 Amps

CAT. NO. 1217

SOLDER

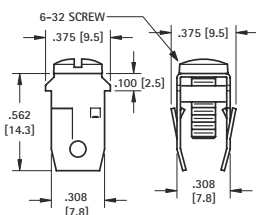

SPECIFICATIONS

Terminal: .020 (.51) Steel, Tin Plate
Screw: Steel, Zinc Plate,
 (Screw Installed & Captivated)
Rated: 15 Amps

CAT. NO. 1272

Mounting Detail

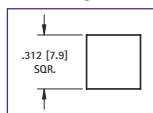

QUICK-FIT

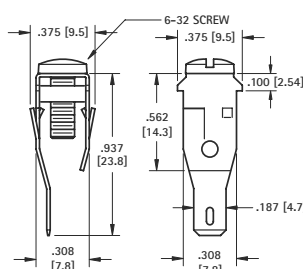

SPECIFICATIONS

Terminal: .020 (.51) Steel, Tin Plate
Screw: Steel, Zinc Plate,
 (Screw Installed & Captivated)
Rated: 15 Amps

CAT. NO. 1273

QUICK-FIT

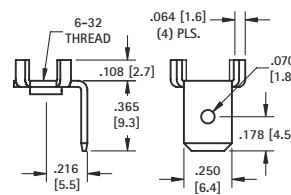

Supplied Unassembled

Mounting Detail

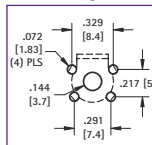

SPECIFICATIONS

Material: .032 (.81) Brass, Nickel Plate
Rated: 15 Amps

CAT. NO. 1247 (No Screw Supplied)

CAT. NO. 1251 (Screw Installed)

BINDING POST TERMINALS (RIVET TYPE)

SPECIFICATIONS Terminal: Brass, Tin Plate **Screw:** Steel, Zinc Plate (Screw Supplied Unassembled)

4-40

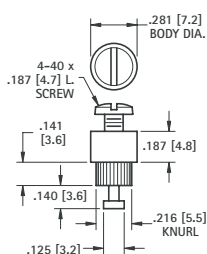

Mounting Hole: .220 (5.6)

CAT. NO. 1537

FOR .093 (2.38) BOARD

6-32

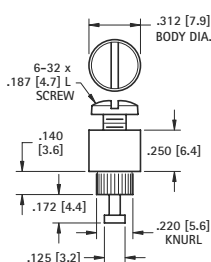

Mounting Hole: .225 (5.7)

CAT. NO. 1535

FOR .093 (2.38) BOARD

8-32

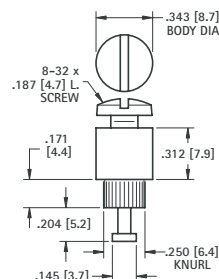

Mounting Hole: .255 (6.5)

CAT. NO. 1536

FOR .125 (3.2) BOARD

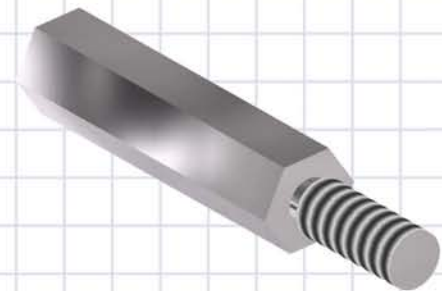
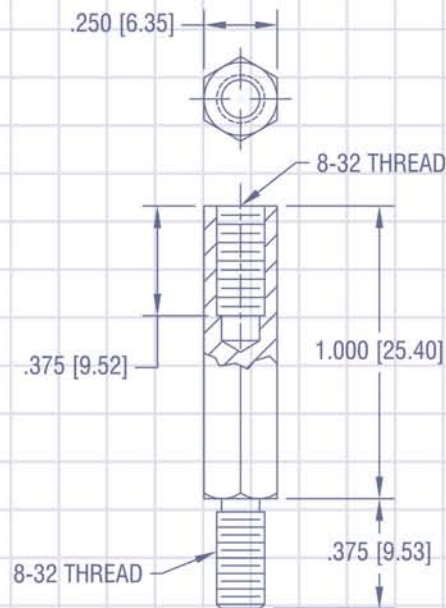
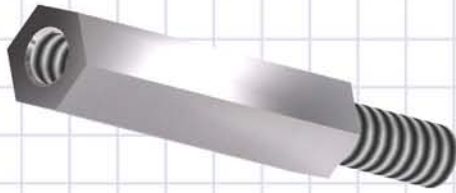

SPACERS & STANDOFFS

Designed for reliability and close tolerance dimensions our diverse selection of spacers and standoffs provide solutions for any design requirements. Available in a wide range of materials and styles, some of the applications include:

- Mechanical support
- Component-to-board mounting requirements
- Board-to-Board PCB mounting
- Board-to-Chassis device mounting
- Eliminate the cost and bulk of backplanes and card cages
- PC/104 & PC/104 plus module mounting
- High Temperature conditions
- Commercial, Military & Industrial environments

Our quality system is ISO 9001:2008 certified. Our products are in compliance with the RoHS and REACH directives. We provide 3D modeling, CAD and other application-engineering support for modifications, special designs or assembly requirements to assist you in choosing the right Keystone product for your application.

DATE

DESCRIPTION

REV.



SECTION CONTENTS

ASSORTMENT/MOUNT KITS

Clear Hole.....	79
Threaded.....	79
Metric.....	79
Nylon support	79
PC-104	70

MOLDED PC SPACERS

Adhesive.....	78
Lock in - Lock in.....	76-78
Lock in - Releasable.....	76-78
Releasable	76-78
Support	78
Threaded.....	77

SPACERS

Clear Hole.....	74
Economy (Rolled).....	74
Retaining Spacer.....	75
Swage / Force Fit.....	73
Stacking.....	77

THREADED STANDOFFS

Ceramic.....	74
Female-Female	70
Hinged.....	75
Male-Female	70
Metric	72
Swage / Force Fit.....	73

MALE/FEMALE THREADED STANDOFFS

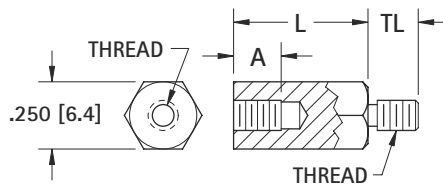

THREAD SIZE	TL EXTERNAL	A INTERNAL
4-40	.187 (4.7)	.250 (6.4)
6-32	.250 (6.4)	.375 (9.5)
8-32	.375 (9.5)	.375 (9.5)

Application Note:
For PC/104 applications use length .600 (15.3) 4-40 Thread

CHOICE OF:		
Stainless: ASTM A581/A582	Brass: ASTM-B16 Plating: Nickel (QQ-N-290)	Aluminum: ASTM B211 Plating: Clear Iridite (Mil-C-5541)

4-40 THREAD			
L LENGTH	STAINLESS STEEL CAT. NO.	BRASS CAT. NO.	ALUMINUM CAT. NO.
.250 (6.4)***	8712	8713	8714
.375 (9.5)	2087	7200	8400
.500 (12.7)	2088	1944	8401
.600 (15.2)*	5799	8799	6799
.625 (15.9)	2089	1945	8402
.750 (19.1)	2090	1946	8403
.875 (22.2)	2091	7201	8404
1.000 (25.4)	2092	1947	8405
1.125 (28.6)	2093	7202	8406
1.250 (31.8)	2094	1948	8407
1.375 (34.9)	2095	1949	8408
1.500 (38.1)	2096	1950	8409
1.625 (41.3)	2097	7203	8410
1.750 (44.5)	2098	7205	8411
2.000 (50.8)	2099	1951	8412

6-32 THREAD			
L LENGTH	STAINLESS STEEL CAT. NO.	BRASS CAT. NO.	ALUMINUM CAT. NO.
.250 (6.4)***	8715	8716	8717
.375 (9.5)**	2119	7210	8413
.500 (12.7)	2120	1952	8414
.625 (15.9)	2121	1953	8415
.750 (19.1)	2122	1954	8416
.875 (22.2)	2123	7211	8417
1.000 (25.4)	2124	1644	8418
1.125 (28.6)	2125	7212	8419
1.250 (31.8)	2126	1955	8420
1.375 (34.9)	2127	1956	8421
1.500 (38.1)	2128	1645	8422
1.625 (41.3)	2129	7214	8423
1.750 (44.5)	2130	7215	8424
2.000 (50.8)	2131	1646	8425

8-32 THREAD			
L LENGTH	STAINLESS STEEL CAT. NO.	BRASS CAT. NO.	ALUMINUM CAT. NO.
.250 (6.4)***	8731	8732	8733
.375 (9.5)**	2149	7220	8426
.500 (12.7)	2150	1957	8427
.625 (15.9)	2151	1958	8428
.750 (19.1)	2152	1959	8429
.875 (22.2)	2153	7221	8430
1.000 (25.4)	2154	1960	8431
1.125 (28.6)	2155	7222	8432
1.250 (31.8)	2156	1961	8433
1.375 (34.9)	2157	1962	8434
1.500 (38.1)	2158	1963	8435
1.625 (41.3)	2159	7224	8436
1.750 (44.5)	2160	7225	8437
2.000 (50.8)	2161	1964	8438
2.500 (63.5)	2180	1965	8439
3.000 (76.2)	2181	1966	8440

*PC/104 Standard Length
**Internal Thread .130 (3.3)/.150 (3.8) Deep
***Internal Thread .130 (3.3)/.150 (3.8) Deep

** Internal Thread .250 (6.4) Deep
*** Internal Thread .130 (3.3)/.150 (3.8) Deep

** Internal Thread .250 (6.4) Deep
*** Internal Thread .130 (3.3)/.150 (3.8) Deep

PC 104 MOUNTING KITS

- Designed to ease the assembly of new modules and multi-board stacks.
- Each kit includes all the hardware that is required to mount a single-board.

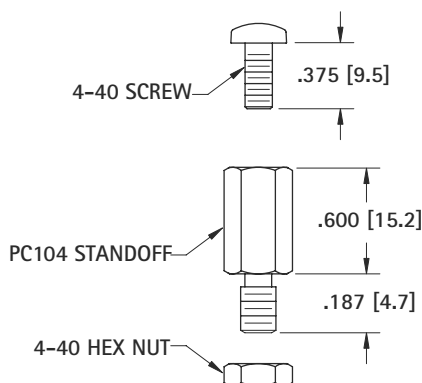

Complete Kit CAT. NO.	Kit Description	Includes Four (4) each:		
		Standoff	Screw	Nut
4799-4	Nylon	4799	9328	9605
5799-4	Stainless Steel	5799	9901	7248-3
6799-4	Aluminum	6799	9301*	9600*
8799-4	Brass	8799	9301*	9600*

* Aluminum and brass kits supplied with steel hardware.

NYLON STANDOFFS

MATERIAL: Nylon 6/6

MALE/FEMALE STANDOFFS

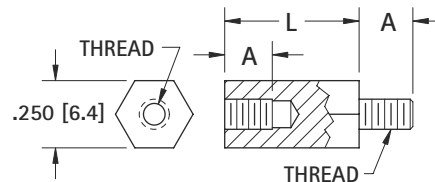

L LENGTH	THREAD SIZE		
	4-40 CAT. NO.	6-32 CAT. NO.	8-32 CAT. NO.
.250 (6.4)***	4800	4814	4828
.375 (9.5)	4801	4815	4829**
.500 (12.7)	4802	4816	4830
.600 (15.2)*	4799	-	-
.625 (15.9)	4803	4817	4831
.750 (19.1)	4804	4818	4832
.875 (22.2)	4805	4819	4833
1.000 (25.4)	4806	4820	4834
1.125 (28.6)	4807	4821	4835
1.250 (31.8)	4808	4822	4836
1.375 (34.9)	4809	4823	4837
1.500 (38.1)	4810	4824	4838
1.625 (41.3)	4811	4825	4839
1.750 (44.5)	4812	4826	4840
2.000 (50.8)	4813	4827	4841

* PC/104 Standard Length
** Internal Thread .250 (6.4) Deep
*** Internal Thread .130 (3.3)/.150 (3.8) Deep

Application Note:
For PC/104 applications use CAT. NO. 4799

THREAD SIZE	A
4-40	.187 (4.7)
6-32	.250 (6.4)
8-32	.375 (9.5)

HEX MALE/FEMALE STANDOFFS

FEMALE THREADED STANDOFFS

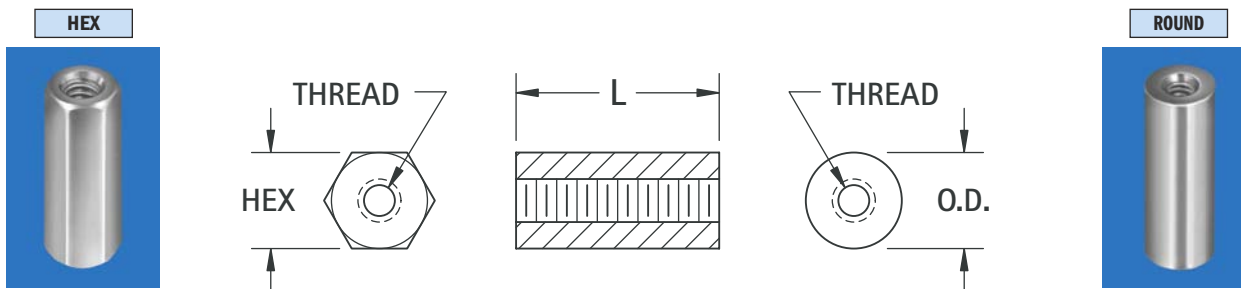

CHOICE OF:				
Stainless: ASTM A581/A582	Brass: per ASTM-B16 Plating: Zinc ASTM B633	Aluminum: ASTM B211 Plating: Clear Iridite Finish	Nylon V2: 6/6 UL Rated 94V-2 Nylon V0: 6/6 UL Rated 94V-0	Phenolic: PBE Grade Natural Color Phenolic

HEX	HEX					LENGTH	ROUND			O.D.
	Nylon V2 Cat. No.	Nylon V0 Cat. No.	Stainless Cat. No.	Brass Cat. No.	Aluminum Cat. No.		Brass Cat. No.	Aluminum Cat. No.	Phenolic Cat. No.	
2-56 THREAD										
.156 (3.9)	—	—	—	1798A	1797A	.187 (4.7)	1802A	1801A	—	.156 (3.9)
	—	—	—	1798B	1797B	.250 (6.4)	1802B	1801B	—	
	—	—	—	1798C	1797C	.312 (7.9)	1802C	1801C	—	
	—	—	—	1798D	1797D	.375 (9.5)	1802D	1801D	—	
4-40 THREAD										
.187 (4.7)	—	—	—	1450	1891	.250 (6.4)	1547	2025	—	—
	—	—	—	1803	1892	.375 (9.5)	1864	2026	—	
	—	—	—	1656	1893	.500 (12.7)	1657	2027	—	
	—	—	—	1804	1894	.625 (15.9)	1865	2028	—	
	—	—	—	1656A	1895	.750 (19.1)	1657A	2029	—	
	—	—	—	1805	1896	.875 (22.2)	1866	2030	—	
	—	—	—	1656B	1897	1.000 (25.4)	1657B	2031	—	
.250 (6.3)	1902A	8440A	1921	1450A	2201	.250 (6.4)	1547A	3478	376	.250 (6.3)
	1902B	8440B	1921A	1450B	2202	.375 (9.5)	1547B	3479	377	
	1902C	8440C	1921B	1450C	2203	.500 (12.7)	1547C	3480	378	
	1902F	8440D	—	1829	1808	.625 (15.9)	1867	1839	—	
	1902D	8440E	1921C	1450D	2204	.750 (19.1)	1547D	3481	379	
	1902G	8440F	—	1830	1809	.875 (22.2)	1876	1846	—	
	1902E	8440G	1921D	1450E	2205	1.000 (25.4)	1547E	3482	380	
	—	—	1921E	1831	2206	1.500 (38.1)	1877	3483	381	
	—	—	1921F	1832	2207	2.000 (50.8)	1878	3484	382	
6-32 THREAD										
.250 (6.3)	1903A	8441A	1922	1451A	2208	.250 (6.4)	1548A	3485	383	.250 (6.3)
	1903B	8441B	1922A	1451B	2209	.375 (9.5)	1548B	3486	384	
	1903C	8441C	1922B	1451C	2210	.500 (12.7)	1548C	3487	385	
	1903F	8441D	—	1451D	1813	.625 (15.9)	1548D	1847	—	
	1903D	8441E	1922C	1451E	2211	.750 (19.1)	1548E	3488	386	
	1903G	8441F	—	1833	1816	.875 (22.2)	1879	1848	—	
	1903E	8441G	1922D	1635	2212	1.000 (25.4)	1548F	3489	387	
	—	—	—	1636	1818	1.250 (31.8)	1881	1853	—	
	—	—	1922E	1637	2213	1.500 (38.1)	1882	3490	388	
	—	—	—	1638	1819	1.750 (44.5)	1883	1855	—	
	—	—	1922F	1639	2214	2.000 (50.8)	1884	3491	389	
	—	—	—	1642	1820	2.250 (57.2)	1885	1856	—	
	—	—	—	1643	1825	2.500 (63.5)	1886	1857	—	
	8-32 THREAD									
.250 (6.3)	1904A	8442A	1923	1474A	2215	.250 (6.4)	1692A	3492	390	.250 (6.3)
	1904B	8442B	1923A	1474B	2216	.375 (9.5)	1692B	3493	391	
	1904C	8442C	1923B	1474C	2217	.500 (12.7)	1692C	3494	392	
	1904F	8442D	—	1834	1827	.625 (15.9)	1887	1858	—	
	1904D	8442E	1923C	1474D	2218	.750 (19.1)	1692D	3495	393	
	1904G	8442F	—	1836	1828	.875 (22.2)	1888	1859	—	
	1904E	8442G	1923D	1474E	2219	1.000 (25.4)	1692E	3496	394	
	—	—	1923E	1837	2220	1.500 (38.1)	1889	3497	395	
	—	—	1923F	1838	2221	2.000 (50.8)	1899	3498	396	
10-32 THREAD										
.312 (7.9)	—	—	1475A	1822A	1821A	.375 (9.5)	3499A	3500A	468	.312 (7.9)
	—	—	1475B	1822B	1821B	.500 (12.7)	3499B	3500B	469	
	—	—	1475C	1822C	1821C	.625 (15.9)	3499C	3500C	—	
	—	—	1475D	1822D	1821D	.750 (19.1)	3499D	3500D	470	
	—	—	1475F	1822F	1821F	1.000 (25.4)	3499F	3500F	471	

NOTE: All standoffs over 1.000 (25.4) are tapped .375 (9.5) min. both ends, except 4-40 standoffs which are tapped .250 (6.4) min.

METRIC STANDOFFS

MALE/FEMALE



FEMALE



THREAD SIZE	TL	A
M2.5	4.0	5.0
M3	8.0	8.0
M4	10.0	11.0

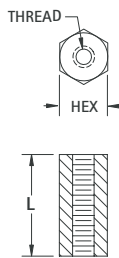
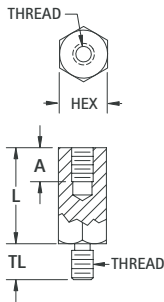

CHOICE OF:		
Stainless: ASTM A581/A582	Brass: ASTM-B16 Plating: Nickel (QQ-N-290)	Aluminum: ASTM B211 Plating: Clear Iridite (Mil-C-5541)

MALE/FEMALE			FEMALE			
STAINLESS CAT. NO.	BRASS CAT. NO.	ALUMINUM CAT. NO.	L	STAINLESS CAT. NO.	BRASS CAT. NO.	ALUMINUM CAT. NO.
4.5 HEX DIA. (M2.5 THREAD)						
—	—	—	5.0	24460	24380	24420
—	—	—	6.0	24461	24381	24421
—	—	—	8.0	24462	24382	24422
24283	24307	24331	10.0	24463	24383	24423
24284	24308	24332	12.0	24464	24384	24424
24285	24309	24333	15.0	24465	24385	24425
24286	24310	24334	18.0	24466	24386	24426
24287	24311	24335	20.0	24467	24387	24427
24288	24312	24336	25.0	24468	24388	24428
5.0 HEX DIA. (M3 THREAD)						
—	—	—	5.0	24470	24390	24430
—	—	—	6.0	24471	24391	24431
—	—	—	8.0	24472	24392	24432
24289	24313	24337	10.0	24473	24393	24433
24290	24314	24338	12.0	24474	24394	24434
24291	24315	24339	15.0	24475	24395	24435
24292	24316	24340	18.0	24476	24396	24436
24293	24317	24341	20.0	24477	24397	24437
24294	24318	24342	25.0	24478	24398	24438
5.5 HEX DIA. (M3 THREAD)						
—	—	—	5.0	24480	24400	24440
—	—	—	6.0	24481	24401	24441
—	—	—	8.0	24482	24402	24442
24295	24319	24343	10.0	24483	24403	24443
24296	24320	24344	12.0	24484	24404	24444
24297	24321	24345	15.0	24485	24405	24445
24298	24322	24346	18.0	24486	24406	24446
24299	24323	24347	20.0	24487	24407	24447
24300	24324	24348	25.0	24488	24408	24448
6.0 HEX DIA. (M4 THREAD)						
—	—	—	5.0	24490	24410	24450
—	—	—	6.0	24491	24411	24451
—	—	—	8.0	24492	24412	24452
24301**	24325**	24349**	10.0	24493	24413	24453
24302*	24326*	24350*	12.0	24494	24414	24454
24303	24327	24351	15.0	24495	24415	24455
24304	24328	24352	18.0	24496	24416	24456
24305	24329	24353	20.0	24497	24417	24457
24306	24330	24354	25.0	24498	24418	24458

* Internal Thread: 8.0mm deep ** Internal Thread: 6.0mm deep
Note: Female standoffs longer than 19mm may be tapped from both ends

METRIC NYLON STANDOFFS

Material: Nylon 6/6, UL Rated 94V-2

MALE/FEMALE



FEMALE



THREAD SIZE	A
M3	8.0
M4	9.5

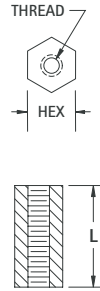
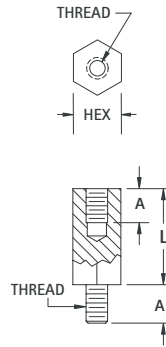

MALE/FEMALE		FEMALE	
CAT. NO.	L	CAT. NO.	L
5.0 HEX (M3 THREAD)			
—	6.0	25508	6.0
—	8.0	25509	8.0
25501	10.0	25510	10.0
25502	12.0	25511	12.0
25503	15.0	25512	15.0
25504	18.0	25513	18.0
25505	20.0	25514	20.0
25506	25.0	25515	25.0
6.0 HEX (M4 THREAD)			
—	6.0	25528	6.0
—	8.0	25529	8.0
25521	10.0	25530	10.0
25522	12.0	25531	12.0
25523	15.0	25532	15.0
25524	18.0	25533	18.0
25525	20.0	25534	20.0
25526	25.0	25535	25.0

Note: Female standoffs longer than 19mm may be tapped from both ends

METRIC NYLON LOCK-IN SUPPORT

- One end locks into chassis, the other end locks into the PC Board.

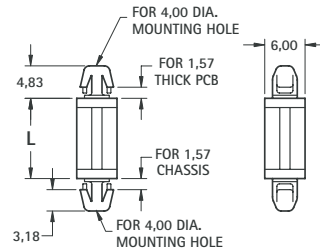

CAT. NO.	L DIM
8843	3.0
8844	4.0
8845	6.0
8846	8.0
8847	10.0
8848	12.0
8849	14.0
8850	16.0
8851	18.0

Material: Nylon 6/6, UL Rated 94V-0

METRIC SCREWS

Choice of: Steel, Zinc Plate • Nylon: 6/6, UL Rated 94V-2

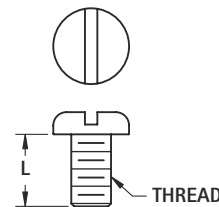
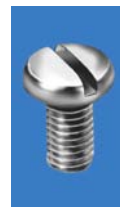

STEEL CAT. NO.	L	NYLON 6/6 CAT. NO.
M2.5 THREAD		
29301	6.00	29331
29304	12.00	29334
29306	16.00	29336
M3 THREAD		
29311	6.00	29341
29314	12.00	29344
29316	16.00	29346
29318	25.00	29348
M4 THREAD		
29321	6.00	29351
29324	12.00	29354
29326	16.00	29356
29328	25.00	29358

See page 132 for metric nuts

SWAGE THREADED STANDOFFS

ROUND

HEX

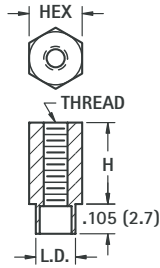
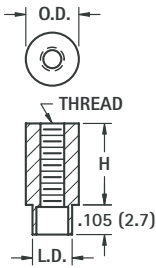

MATERIAL: Brass, ASTM-B16, Nickel Plate (QQ-N-290)
For .062 (1.52) thick boards

ROUND CAT. NO.	H HEIGHT ABOVE PANEL	L.D. SHANK DIAMETER	HEX CAT. NO.
2-56 THREAD × .156 (4.0) O.D.			
1589-2	.125 (3.2)	.125 (3.2)	1731-2
1590-2	.187 (4.7)	.125 (3.2)	1734-2
1591-2	.250 (6.4)	.125 (3.2)	1740-2
1596-2	.375 (9.5)	.125 (3.2)	1743-2
4-40 THREAD × .187 (4.7) O.D.			
2260-2	.125 (3.2)	.139 (3.5)	2270-2
2261-2	.187 (4.7)	.139 (3.5)	2271-2
2262-2	.250 (6.4)	.139 (3.5)	2272-2
2263-2	.375 (9.5)	.139 (3.5)	2273-2
2264-2	.500 (12.7)	.139 (3.5)	2274-2
4-40 THREAD × .250 (6.4) O.D.			
1560A	.125 (3.2)	.187 (4.7)	1653-2
1790-2	.187 (4.7)	.187 (4.7)	1746-2
1650-2	.250 (6.4)	.187 (4.7)	1627-2
1651-2	.375 (9.5)	.187 (4.7)	1628-2
1623-2	.500 (12.7)	.187 (4.7)	1629-2
1624-2	.625 (15.9)	.187 (4.7)	1654-2
1625-2	.750 (19.1)	.187 (4.7)	1655-2
1792-2	.875 (22.2)	.187 (4.7)	1749-2
1652-2	1.000 (25.4)	.187 (4.7)	1630-2
6-32 THREAD × .250 (6.4) O.D.			
1560B	.125 (3.2)	.187 (4.7)	1620-2
1612-2	.187 (4.7)	.187 (4.7)	1752-2
1546	.250 (6.4)	.187 (4.7)	1621-2
1561B	.375 (9.5)	.187 (4.7)	1622-2
1604-2	.500 (12.7)	.187 (4.7)	1758-2
1605-2	.625 (15.9)	.187 (4.7)	1759-2
1608-2	.750 (19.1)	.187 (4.7)	1761-2
1796-2	.875 (22.2)	.187 (4.7)	1775-2
1609-2	1.000 (25.4)	.187 (4.7)	1784-2

SWAGE CLEAR HOLE SPACERS

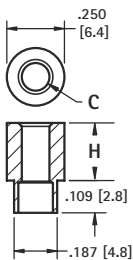

CAT. NO.	H HEIGHT ABOVE PANEL	C HOLE
5058-2	.125 (3.2)	.120 (3.0) For # 4
5060-2	.250 (6.4)	
5061-2	.375 (9.5)	
5062-2	.500 (12.7)	
5059-2	.125 (3.2)	.140 (3.5) For # 6
5063-2	.250 (6.4)	
5064-2	.375 (9.5)	
5065-2	.500 (12.7)	

MATERIAL: Brass, ASTM-B16, Nickel Plate (QQ-N-290)
For .062 (1.52) thick boards

FORCE-FIT STANDOFFS

ROUND

A broaching-type fastener/standoff for installation in panels and circuit boards .060 (1.52) and thicker made of plastic and other non-ductile materials. Available threaded or with clearance holes. Easy to install, presses into punched or drilled holes.

MATERIAL: Stainless Steel per ASTM-A581/A582

MOUNTING HOLES:

- .147 (3.7) hole for 2-56
- .166 (4.2) hole for 4-40
- .213 (5.4) hole for 6-32

TOLERANCE ON MOUNTING HOLES:

+0.003/-0.000

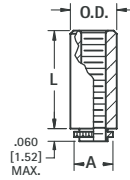

Threaded

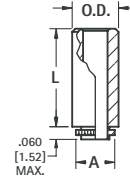

Clear Hole

THREADED				
CAT. NO.	L LENGTH	O.D.	A	THREAD
4860	.065 (1.7)	.219 (5.6)	.165 (4.2)	2-56
4861	.065 (1.7)	.219 (5.6)	.184 (4.7)	
4862	.125 (3.2)	.219 (5.6)	.184 (4.7)	4-40
4863	.250 (6.4)	.219 (5.6)	.184 (4.7)	
4864	.375 (9.5)	.219 (5.6)	.184 (4.7)	
4865 *	.500 (12.7)	.219 (5.6)	.184 (4.7)	
4866	.065 (1.7)	.281 (7.1)	.231 (5.9)	6-32
4867	.125 (3.2)	.281 (7.1)	.231 (5.9)	
4868	.250 (6.4)	.281 (7.1)	.231 (5.9)	
4869	.375 (9.5)	.281 (7.1)	.231 (5.9)	
4870 *	.500 (12.7)	.281 (7.1)	.231 (5.9)	

*Thread depth .375 (9.5)

CLEAR HOLE				
CAT. NO.	L LENGTH	O.D.	A	HOLE
4850	.065 (1.7)	.219 (5.6)	.184 (4.7)	.116 (2.9) For # 4
4851	.125 (3.2)	.219 (5.6)	.184 (4.7)	
4852	.250 (6.4)	.219 (5.6)	.184 (4.7)	
4853	.375 (9.5)	.219 (5.6)	.184 (4.7)	
4854	.500 (12.7)	.219 (5.6)	.184 (4.7)	.143 (3.6) For # 6
4855	.065 (1.7)	.281 (7.1)	.231 (5.9)	
4856	.125 (3.2)	.281 (7.1)	.231 (5.9)	
4857	.250 (6.4)	.281 (7.1)	.231 (5.9)	
4858	.375 (9.5)	.281 (7.1)	.231 (5.9)	
4859	.500 (12.7)	.281 (7.1)	.231 (5.9)	

SWAGE STAKING TOOLS

Precision made staking tool kits are made from .250 (6.4) diameter heat treated steel, zinc plated. Each kit includes the correct swage top staking tool anvil to create a professional appearance. These tools may be used with an arbor press or hand tapped.

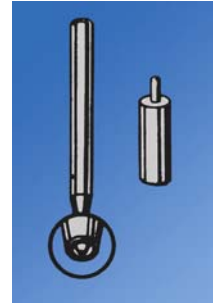

CAT. NO.	STANDOFF DIA.	THREAD	HOLE SIZE
TL-19	.156 (4.0)	2-56	-
TL-22	.187 (4.7)	4-40	-
TL-20	.250 (6.4)	4-40	-
TL-21	.250 (6.4)	6-32	.120 (3.0)

ROUND CLEAR HOLE SPACERS

CLEAR HOLE	O.D.	L LENGTH	BRASS CAT. NO.	ALUMINUM CAT. NO.
.120 (3.0) For #4	.250 (6.4)	.125 (3.2)	1909	2036
		.250 (6.4)	1454A	3457
		.375 (9.5)	1454B	3458
		.500 (12.7)	1454C	3459
		.625 (15.9)	1919	2314
		.750 (19.1)	1454D	3460
		.875 (22.2)	1920	3402
		1.000 (25.4)	1454E	3461
		1.500 (38.1)	1924	3462
		2.000 (50.8)	1925	3463
.140 (3.5) For #6	.250 (6.4)	.125 (3.2)	1934	3403
		.250 (6.4)	1457A	3464
		.375 (9.5)	1457B	3465
		.500 (12.7)	1457C	3466
		.625 (15.9)	1935	3429
		.750 (19.1)	1457D	3467
		.875 (22.2)	1936	3438
		1.000 (25.4)	1457E	3468
		1.500 (38.1)	1937	3469
		2.000 (50.8)	1938	3470
.171 (4.3) For #8	.250 (6.4)	.125 (3.2)	1942	4258
		.250 (6.4)	1480	3471
		.375 (9.5)	1481	3472
		.500 (12.7)	1482	3473
		.625 (15.9)	2032	4259
		.750 (19.1)	1483	3474
		.875 (22.2)	2033	4260
		1.000 (25.4)	1484	3475
		1.500 (38.1)	2034	3476
		2.000 (50.8)	2035	3477
.196 (5.0) For #10	.312 (7.9)	.250 (6.4)	1662	4261
		.375 (9.5)	1663	4262
		.500 (12.7)	1664	4263
		.625 (15.9)	1665	4264
		.750 (19.1)	1666	4265
		.875 (22.2)	1667	4266
		1.000 (25.4)	1668	4267
		1.500 (38.1)	1669	4268
		2.000 (50.8)	1672	4269

MATERIAL:
 Brass: ASTM-B16, Nickel Plate (QQ-N-290)
 Aluminum: ASTM B211, Clear Iridite (MIL-C-5541)
 Nylon: Nylon 6/6, UL Rated 94V-2
 Phenolic: PBE Grade Natural Color Phenolic

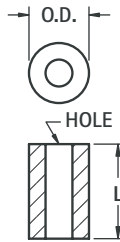

NYLON CAT. NO.	PHENOLIC CAT. NO.	L LENGTH	O.D.	CLEAR HOLE
875	—	.125 (3.2)	.250 (6.4)	.120 (3.0) For #4
876	360	.250 (6.4)		
877	361	.375 (9.5)		
878	362	.500 (12.7)		
879	—	.625 (15.9)		
880	363	.750 (19.1)		
881	—	.875 (22.2)		
882	364	1.000 (25.4)		
779	365	1.500 (38.1)		
—	366	2.000 (50.8)		
883	—	.125 (3.2)	.250 (6.4)	.140 (3.5) For #6
884	367	.250 (6.4)		
885	368	.375 (9.5)		
886	369	.500 (12.7)		
887	—	.625 (15.9)		
888	370	.750 (19.1)		
889	—	.875 (22.2)		
890	371	1.000 (25.4)		
789	372	1.500 (38.1)		
—	373	2.000 (50.8)		
891	—	.125 (3.2)	.250 (6.4)	.171 (4.3) For #8
892	1490	.250 (6.4)		
893	1491	.375 (9.5)		
894	1492	.500 (12.7)		
895	—	.625 (15.9)		
896	1493	.750 (19.1)		
897	—	.875 (22.2)		
898	1494	1.000 (25.4)		
799	374	1.500 (38.1)		
—	375	2.000 (50.8)		
790	453	.250 (6.4)	.312 (7.9)	.196 (5.0) For #10
791	454	.375 (9.5)		
792	455	.500 (12.7)		
793	—	.625 (15.9)		
794	456	.750 (19.1)		
795	—	.875 (22.2)		
796	457	1.000 (25.4)		
797	458	1.500 (38.1)		
—	459	2.000 (50.8)		

ALUMINUM ECONOMY SPACERS

- Made of flat strip aluminum and rolled on precision equipment.
- Assures maximum bearing surface, square ends.

Aluminum:
5052-H34 per QQ-A-250/8b



- Tight Joint on Outside Diameter

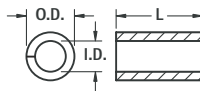

SPACER FOR	I.D.	O.D. REF.
# 4	.120 (3.0)	.167 (4.3)
# 6	.148 (3.8)	.193 (4.9)
# 8	.176 (4.5)	.232 (5.9)

L LENGTH	SCREW CLEARANCE		
	# 4 CAT. NO.	# 6 CAT. NO.	# 8 CAT. NO.
.187 (4.7)	397	—	—
.250 (6.4)	398	405	412
.312 (7.9)	399	406	413
.375 (9.5)	400	407	414
.437 (11.1)	401	408	415
.500 (12.7)	402	409	416
.625 (15.9)	403	410	417

L LENGTH	SCREW CLEARANCE		
	# 4 CAT. NO.	# 6 CAT. NO.	# 8 CAT. NO.
.750 (19.1)	418	425	432
.875 (22.2)	419	426	433
1.000 (25.4)	420	427	434
1.250 (31.8)	421	428	435
1.500 (38.1)	422	429	436
1.750 (44.5)	—	430	437
2.000 (50.8)	—	—	438

CERAMIC STANDOFFS

- Ideal for very high temperature conditions
- Commercial and military types available
- Military types meet MIL-1-010, NL # clearly marked
- Exceptional strength in compression and tension
- Withstands very high voltage without flashover
- Special sizes available upon request

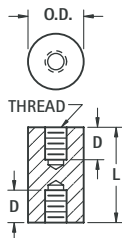

MATERIAL: Grade L5 Ceramic

COMMERCIAL				
CAT. NO.	L LENGTH	O.D.	T THREAD	D DEPTH
7710	.250 (6.4)	.250 (6.4)	6-32	THRU
7711	.500 (12.7)	.250 (6.4)	6-32	.156 (4.0)
7712	.375 (9.5)	.375 (9.5)	6-32	.156 (4.0)
7713	.500 (12.7)	.375 (9.5)	6-32	.156 (4.0)
7714	.500 (12.7)	.500 (12.7)	6-32	.140 (3.6)
7715	.750 (19.1)	.500 (12.7)	6-32	.250 (6.4)
7716	1.000 (25.4)	.500 (12.7)	6-32	.375 (9.5)
7717	1.500 (38.1)	.500 (12.7)	6-32	.562 (14.3)
7718	2.500 (63.5)	.500 (12.7)	6-32	.500 (12.7)
7719	2.500 (63.5)	.750 (19.1)	1/4 - 20	.750 (19.1)
7720	4.000 (101.6)	.750 (19.1)	1/4 - 20	.750 (19.1)

MILITARY

CAT. NO.	L LENGTH	O.D.	T THREAD	D DEPTH	NL #
7661	.500 (12.7)	.375 (9.5)	6-32	.156 (4.0)	NL523W01-004
7662	.625 (15.9)	.375 (9.5)	6-32	.250 (6.4)	NL523W01-005
7663	.625 (15.9)	.500 (12.7)	8-32	.187 (4.7)	NL523W02-005
7664	.750 (19.1)	.375 (9.5)	6-32	.250 (6.4)	NL523W01-006
7665	.750 (19.1)	.500 (12.7)	8-32	.250 (6.4)	NL523W02-006
7666	1.000 (25.4)	.375 (9.5)	6-32	.375 (9.5)	NL523W01-008
7667	1.000 (25.4)	.500 (12.7)	8-32	.375 (9.5)	NL523W02-008
7668	1.000 (25.4)	.750 (19.1)	10-32	.375 (9.5)	NL523W03-008
7669	1.250 (31.8)	.375 (9.5)	6-32	.375 (9.5)	NL523W01-010
7670	1.250 (31.8)	.500 (12.7)	8-32	.375 (9.5)	NL523W02-010
7671	1.250 (31.8)	1.000 (25.4)	1/4 - 20	.437 (11.1)	NL523W04-010
7672	1.500 (38.1)	.375 (9.5)	6-32	.375 (9.5)	NL523W01-012
7673	1.500 (38.1)	.500 (12.7)	8-32	.375 (9.5)	NL523W02-012
7674	1.500 (38.1)	.750 (19.1)	10-32	.375 (9.5)	NL523W03-012
7675	1.500 (38.1)	1.000 (25.4)	1/4 - 20	.500 (12.7)	NL523W04-012
7676	2.000 (50.8)	.375 (9.5)	6-32	.375 (9.5)	NL523W01-016
7677	2.000 (50.8)	.500 (12.7)	8-32	.375 (9.5)	NL523W02-016
7678	2.000 (50.8)	.750 (19.1)	10-32	.375 (9.5)	NL523W03-016

NYLON RETAINING SPACERS

Similar to our standard spacers, but with a specially configured I.D. designed to grip the outside of the screw shank. The spacer slides on the screw easily, but is retained on the screw. For use in applications requiring pre-assembly of the screw and spacer, to reduce final assembly cost.

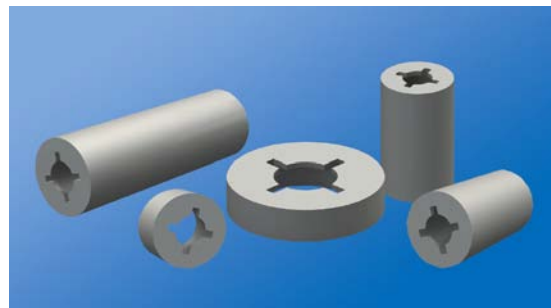
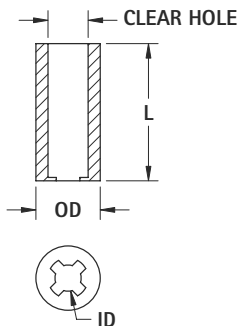

CAT. NO.	.156 (3.9) Clear Hole for #4 Screw		
	LENGTH	O.D.	I.D.
2341	.125 (3.2)	.250 (6.4)	.102 (2.6)
2342	.250 (6.4)		
2343	.375 (9.5)		
2344	.500 (12.7)		
2345	.625 (15.9)		
2346	.750 (19.1)		
2347	.875 (22.2)		
2348	1.00 (25.4)		

CAT. NO.	.198 (5.0) Clear Hole for #6 Screw		
	LENGTH	O.D.	I.D.
2361	.125 (3.2)	.312 (7.9)	.128 (3.3)
2362	.250 (6.4)		
2363	.375 (9.5)		
2364	.500 (12.7)		
2365	.625 (15.9)		
2366	.750 (19.1)		
2367	.875 (22.2)		
2368	1.00 (25.4)		

CAT. NO.	.240 (6.1) Clear Hole for #8 Screw		
	LENGTH	O.D.	I.D.
2381	.125 (3.2)	.375 (9.5)	.152 (3.8)
2382	.250 (6.4)		
2383	.375 (9.5)		
2384	.500 (12.7)		
2385	.625 (15.9)		
2386	.750 (19.1)		
2387	.875 (22.2)		
2388	1.00 (25.4)		

CAT. NO.	.277 (7.0) Clear Hole for #10 Screw		
	LENGTH	O.D.	I.D.
2391	.125 (3.2)	.500 (12.7)	.177 (4.5)
2392	.250 (6.4)		
2393	.375 (9.5)		
2394	.500 (12.7)		
2395	.625 (15.9)		
2396	.750 (19.1)		
2397	.875 (22.2)		
2398	1.00 (25.4)		

HINGED STANDOFFS

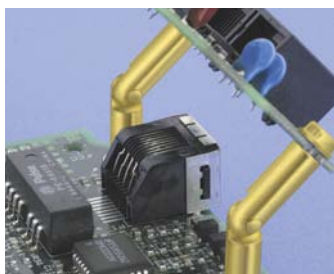

- Applications unlimited
- Time saving
- Space saving
- Interconnect circuits or services without danger of shorting

MATERIAL:

Brass, ASTM-B16. Zinc Plate and Yellow Chromate



FEMALE/FEMALE



CAT. NO.	L LENGTH	U	P	D DIAMETER	T THREAD
351	.750 (19.1)	.172 (4.4)	.375 (9.5)	.187 (4.7)	4-40
352	1.000 (25.4)	.250 (6.4)	.625 (15.9)		
330	1.250 (31.8)	.250 (6.4)	.625 (15.9)		
353	.750 (19.1)	.172 (4.4)	.375 (9.5)	.250 (6.4)	6-32
354	1.000 (25.4)	.250 (6.4)	.625 (15.9)		
331	1.250 (31.8)	.250 (6.4)	.625 (15.9)		
355	.750 (19.1)	.172 (4.4)	.375 (9.5)	.250 (6.4)	8-32
356	1.000 (25.4)	.250 (6.4)	.625 (15.9)		
332	1.250 (31.8)	.250 (6.4)	.625 (15.9)		

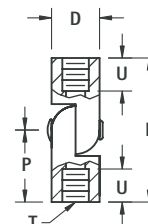

MALE/FEMALE



CAT. NO.	L LENGTH	S	U	D DIAMETER	T THREAD
333	.625 (15.9)	.250 (6.4)	.172 (4.4)	.187 (4.7)	4-40
334	.875 (22.2)	.250 (6.4)	.250 (6.4)		
335	.625 (15.9)	.312 (7.9)	.172 (4.4)	.250 (6.4)	6-32
336	.875 (22.2)	.312 (7.9)	.250 (6.4)		
337	.625 (15.9)	.312 (7.9)	.172 (4.4)	.250 (6.4)	8-32
338	.875 (22.2)	.312 (7.9)	.250 (6.4)		

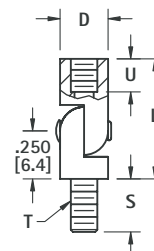

MALE/MALE



CAT. NO.	L LENGTH	S	P	D DIAMETER	T THREAD
357	.500 (12.2)	.250 (6.4)	.250 (6.4)	.187 (4.7)	4-40
358	.500 (12.2)	.312 (7.9)	.250 (6.4)	.250 (6.4)	6-32
359	.500 (12.2)	.312 (7.9)	.250 (6.4)	.250 (6.4)	8-32

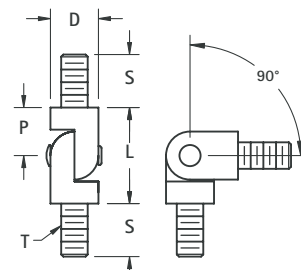

INSULATED PC SPACER/SUPPORTS

- Board will be electrically insulated, eliminates need for insulating washers
- No tool required for installation
- Easy snap-in assembly
- One piece design eliminates the need for additional screws and nuts
- Fits snug onto board
- Accommodates varying board thicknesses
- Flame retardant

.156 (4.0)

SLIMLINE TENSION-FIT



.187 (4.8)

- One end permanently attaches to .070 (1.78) max. thick chassis
- Other end tension fits to .062 (1.57) max. thick PC board
- Board is easily releasable for repairs or upgrades
- Low insertion force

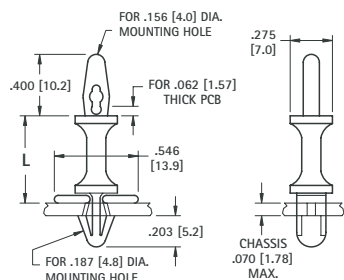

CAT. NO.	L LENGTH
1927A	.250 (6.4)
1928A	.375 (9.5)
1929A	.500 (12.7)
1930A	.625 (15.9)
1931A	.750 (19.1)
1932A	.875 (22.2)
1933A	1.000 (25.4)

MATERIAL: Nylon 6/6, UL Rated 94V-0

.156 (4.0)

SLIMLINE LOCK-IN



.187 (4.8)

- One end permanently attaches to .070 (1.78) max. thick chassis
- Other end permanently attaches to .062 (1.57) max. thick PC board
- Low insertion force
- Small footprint frees up board space.

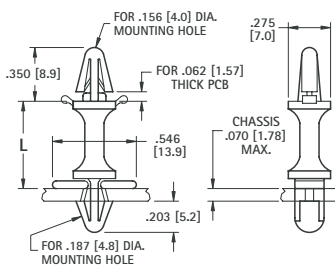

CAT. NO.	L LENGTH
1927B	.250 (6.4)
1928B	.375 (9.5)
1929B	.500 (12.7)
1930B	.625 (15.9)
1931B	.750 (19.1)
1932B	.875 (22.2)
1933B	1.000 (25.4)

MATERIAL: Nylon 6/6, UL Rated 94V-0

.156 (4.0)

STURDY TENSION-FIT



.187 (4.8)

- One end permanently attaches to .031 (.79) - .078 (2.0) thick chassis
- Other end tension fits to .062 (1.57) max thick PC board
- Board is easily releasable for repairs or upgrades
- Sturdy support due to high contact area

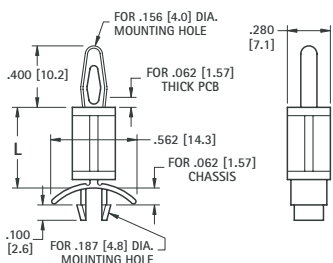

CAT. NO.	L LENGTH
8800	.187 (4.7)
8801	.250 (6.4)
8802	.375 (9.5)
8803	.500 (12.7)
8804	.625 (15.9)
8805	.750 (19.1)
8806	.875 (22.2)

MATERIAL: Nylon 6/6, UL Rated 94V-0

.156 (4.0)

STURDY LOCK-IN



.156 (4.0)

- Both ends permanently attaches to .031 (.79) - .078 (2.0) thick chassis or board
- Sturdy support due to high contact area

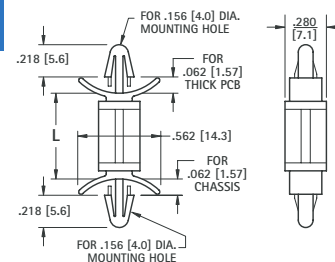

CAT. NO.	L LENGTH
8815	.187 (4.7)
8816	.250 (6.4)
8817	.375 (9.5)
8818	.500 (12.7)
8819	.625 (15.9)
8820	.750 (19.1)
8821	.875 (22.2)

MATERIAL: Nylon 6/6, UL Rated 94V-0

.156 (4.0)

STURDY LOCK-IN RELEASE



.187 (4.8)

- Locks onto .062 (1.57) thick PC board
- Board is positively locked until manually released
- Board is easily releasable for repairs or upgrades
- Sturdy support due to high contact area with chassis

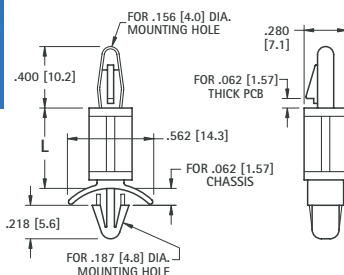

CAT. NO.	L LENGTH
8807	.187 (4.7)
8808	.250 (6.4)
8809	.375 (9.5)
8810	.500 (12.7)
8811	.625 (15.9)
8812	.750 (19.1)
8813	.875 (22.2)
8814	1.000 (25.4)

MATERIAL: Nylon 6/6, UL Rated 94V-0

.125 (3.2)

SLIMLINE LOCK-IN RELEASE



.125 (3.2)

- Locks onto .062 (1.57) thick PC board
- Board is positively locked until manually unlocked
- Board is easily releasable for repairs or upgrades
- Compact design uses smaller mounting holes

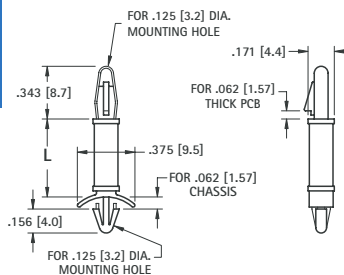

CAT. NO.	L LENGTH
8871	.187 (4.7)
8872	.250 (6.4)
8873	.375 (9.5)
8874	.500 (12.7)
8875	.625 (15.9)

MATERIAL: Nylon 6/6, UL Rated 94V-0

INSULATED PC SPACERS/SUPPORTS

- Board will be electrically insulated, eliminates need for insulating washers
- Easy snap-in assembly
- No tool required for installation
- Designed for .062 (1.57) thick boards

- One piece design eliminates the need for additional screws and nuts
- Slim design frees up board space

.125 (3.2)

TENSION-FIT



- One end permanently attaches to chassis
- Other end secures board with tension fit.
- Board easily releasable for repairs or upgrades

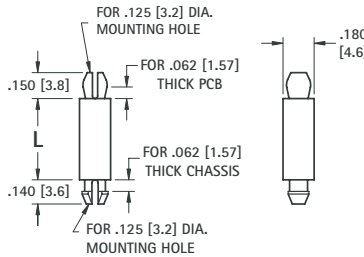

CAT. NO.	L LENGTH
8879	.125 (3.2)
8880	.187 (4.7)
8881	.250 (6.4)
8882	.375 (9.5)
8883	.500 (12.7)
8884	.625 (15.9)
8885	.750 (19.1)
8886	.875 (22.2)
8887	1.000 (25.4)

MATERIAL: Nylon 6/6, UL Rated 94V-0

.100 (2.6)

EASY LOCK-IN



- Both ends permanently attach to chassis and board
- Teardrop style mounting end eases assembly
- Low protrusion above board and under chassis

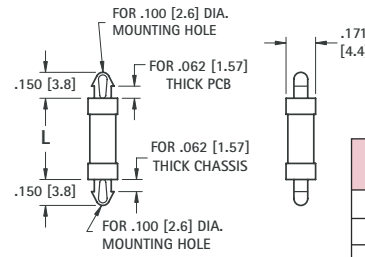

CAT. NO.	L LENGTH
8888	.125 (3.2)
8889	.187 (4.7)
8890	.250 (6.4)
8891	.375 (9.5)
8892	.500 (12.7)
8893	.625 (15.9)

MATERIAL: Nylon 6/6, UL Rated 94V-0

.125 (3.2)

LOCK-IN



- Both ends permanently attach to chassis and board
- Secure mounting end design allows for taller spacing

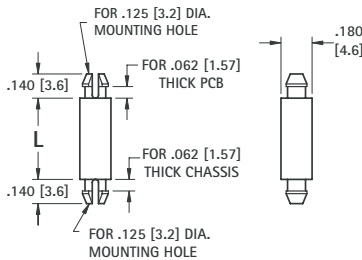

CAT. NO.	L LENGTH
9018	.125 (3.2)
9019	.187 (4.7)
9020	.250 (6.4)
9021	.375 (9.5)
9022	.500 (12.7)
9023	.625 (15.9)
9024	.750 (19.1)
9025	.875 (22.2)
9026	1.000 (25.4)

MATERIAL: Nylon 6/6, UL Rated 94V-0

.156 (4.0)

THREADED



THREAD

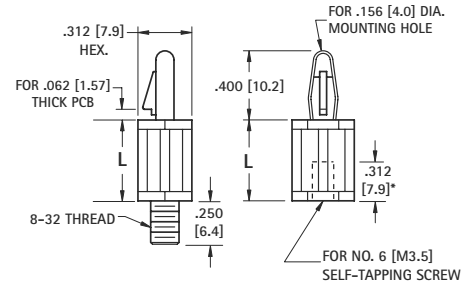

- One end attaches to chassis with screw or tapped hole
- Other end snap locks onto .062 (1.6) board
- Board is releasable for easy repair or upgrades

MALE CAT. NO.	L LENGTH	FEMALE CAT. NO.
9048	.250 (6.4)	9041
9049	.375 (9.5)	9042
9050	.500 (12.7)	9043
9051	.625 (15.9)	9044
9052	.750 (19.1)	9045
9053	.875 (22.2)	9046
9054	1.000 (25.4)	9047

MATERIAL: Nylon 6/6, UL Rated 94V-0

THRU HOLE SPACERS

One end locks into panel. Clear hole designs for #4, #6 or #8 screw.



- Base has larger surface area. Will not deform under heavy pre-load.

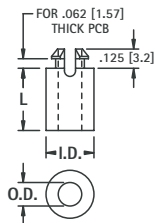

CAT. NO.	L LENGTH	Outside Diameter	Inside Diameter	Mounting Hole	Screw Size
9027	.125 (3.2)				
9028	.187 (4.7)				
9029	.250 (6.4)	.260 (6.6)	.125 (3.2)	.187 (4.7)	#4
9030	.375 (9.5)				
9031	.500 (12.7)				
9032	.625 (15.9)				
9033	.250 (6.4)				
9034	.375 (9.5)	.281 (7.1)	.153 (3.9)	.234 (5.9)	#6
9035	.500 (12.7)				
9036	.625 (15.9)				
9037	.250 (6.4)				
9038	.375 (9.5)	.281 (7.1)	.169 (4.3)	.234 (5.9)	#8
9039	.500 (12.7)				
9040	.625 (15.9)				

MATERIAL: Nylon 6/6, UL Rated 94V-0

STACKING SPACERS

One end locks into panel. Clear hole designs for #4, #6 or #8 screw.



- Spacers can be stacked for multiple level PC board applications
- Self-aligning

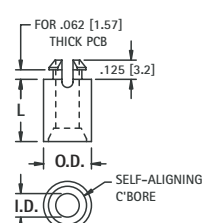

CAT. NO.	L LENGTH	Outside Diameter	Inside Diameter	Mounting Hole	Screw Size
8829	.125 (3.2)				
8830	.187 (4.7)				
8831	.250 (6.4)	.260 (6.6)	.125 (3.2)	.187 (4.7)	#4
8832	.375 (9.5)				
8833	.500 (12.7)				
8834	.625 (15.9)				
8835	.250 (6.4)				
8836	.375 (9.5)	.312 (7.9)	.153 (3.9)	.234 (5.9)	#6
8837	.500 (12.7)				
8838	.625 (15.9)				
8839	.250 (6.4)				
8840	.375 (9.5)	.312 (7.9)	.169 (4.3)	.234 (5.9)	#8
8841	.500 (12.7)				
8842	.625 (15.9)				

MATERIAL: Nylon 6/6, UL Rated 94V-0

INSULATED PC SPACERS/SUPPORTS

- Board will be electrically insulated, eliminates need for insulating washers
- No tool required for installation • Easy snap-in assembly

ADHESIVE LOCK-IN RELEASE SUPPORTS

- One end attaches to chassis with self adhesive pads
- No drilling to chassis required leaving outside in perfect condition
- Other end snap into .062 (1.57) board
- Board is easily releasable for repair or upgrade

.156 (4.0)

ADHESIVE MOUNT

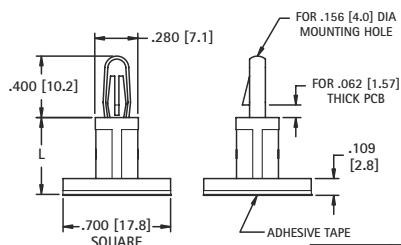

CAT. NO.	L LENGTH
9080	.187 (4.7)
9081	.250 (6.4)
9082	.375 (9.5)
9083	.500 (12.7)
9084	.625 (15.9)

Material: Nylon 6/6, UL Rated 94V-0

.125 (3.2)

ADHESIVE MOUNT SLIMLINE

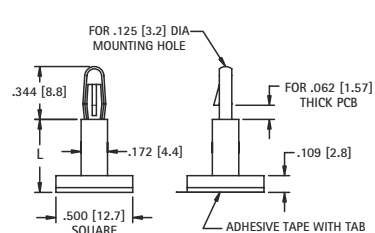
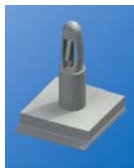

CAT. NO.	L LENGTH
9070	.187 (4.7)
9071	.250 (6.4)
9072	.375 (9.5)
9073	.500 (12.7)
9074	.625 (15.9)

Material: Nylon 6/6, UL Rated 94V-0

PC SPACER SUPPORTS

- One end locks into chassis • Other end supports the PC Board • Ideal for mid supports of large boards
- Simplifies assembly for multiple support applications • Reduces the amount of holes required in PC board

STURDY SUPPORT



- One end permanently attaches to .062 (1.57) chassis
- Accommodates varying board thicknesses
- Sturdy support due to large contact area

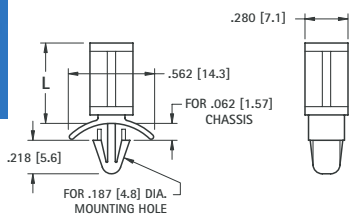

CAT. NO.	L LENGTH
8822	.187 (4.7)
8823	.250 (6.4)
8824	.375 (9.5)
8825	.500 (12.7)
8826	.625 (15.9)
8827	.750 (19.1)
8828	.875 (22.2)

Material: Nylon 6/6, UL Rated 94V-0

SLIMLINE SUPPORT



- One end permanently attaches to .062 (1.57) chassis
- Low protrusion under chassis
- Small diameter frees up space on PC board

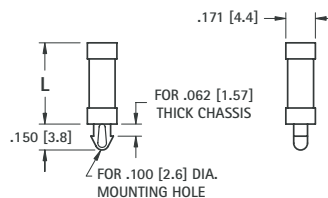

CAT. NO.	L LENGTH
9055	.125 (3.2)
9056	.187 (4.7)
9057	.250 (6.4)
9058	.375 (9.5)
9059	.500 (12.7)
9060	.625 (15.9)

Material: Nylon 6/6, UL Rated 94V-0

REVERSE CHASSIS MOUNT SUPPORTS

- Permanently attaches to .059 (1.51) - .065 (1.65) thick case from outside
- Provides flat clean cosmetic appearance • Ideal for low clearance applications or for mounting directly to case walls

.156 (4.0)

LOCK-IN RELEASE



- End locks onto .062 (1.57) PC board
- Board is positively locked until manually released
- Board is easily releasable for repairs or upgrades

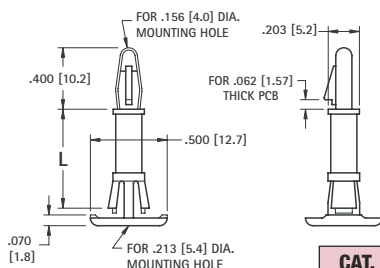

CAT. NO.	L LENGTH
9061	.250 (6.4)
9062	.375 (9.5)
9063	.500 (12.7)
9064	.625 (15.9)

Material: Nylon 6/6, UL Rated 94V-0

.125 (3.2)

SLIMLINE LOCK-IN



- End permanently attaches to .062 (1.57) PC board
- Small footprint frees up PC board space

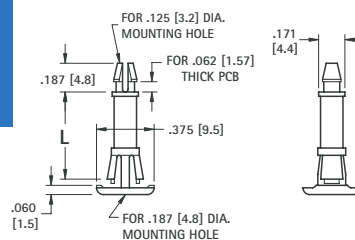

CAT. NO.	L LENGTH
9065	.250 (6.4)
9066	.375 (9.5)
9067	.500 (12.7)
9068	.625 (15.9)

Material: Nylon 6/6, UL Rated 94V-0

INSULATED PC SPACERS/SUPPORTS

SPACERS/STANDOFF ORGANIZER KITS



Maintain a neat complete inventory of the most frequently used spacers and standoffs in day-to-day operations. Choice of 14 different kits of the most popular spacers and standoffs. An assortment of various sizes and styles in Brass, Aluminum and Nylon with tapped or thru hole. Supplied with clear draw cabinet labeled for easy identification.

Kits combine the most frequently used spacers or standoffs for stacking and a multi-stacking prototyping.

SPACER ASSORTMENT KITS



Assortment of 1500 pieces in .250, .375, .500, .750 and 1.000 lengths, with clearance holes for #4, #6 and #8.

100 pieces of each size. Complete with cabinet.

CAT. NO.	KIT SUPPLIED WITH
SPR-13	Brass Nickel Plated Spacers
SPR-34	Aluminum Spacers with Iridite Finish
SPR-8	Nylon 6/6 Spacers

CLEAR HOLE SPACER KITS



Assortment of 400 total spacers: Brass, Aluminum, Nylon, Rolled Aluminum, with lengths of .250, .500, .750 and 1.000.

25 pieces of each size. Complete with cabinet.

CAT. NO.	KIT SUPPLIED WITH
SCR-4	#4 Clear Hole Spacers
SCR-6	#6 Clear Hole Spacers
SCR-8	#8 Clear Hole Spacers

HEX STANDOFF KITS



Assortment of 400 total standoffs: Female-Female standoffs and Male-Female standoffs both Aluminum and Nylon, with lengths of .250, .500, .750 and 1.000.

25 pieces of each size. Complete with cabinet and 25 machine screws with matching thread.

CAT. NO.	KIT SUPPLIED WITH
STR-440	4-40 Threaded Standoffs
STR-632	6-32 Threaded Standoffs
STR-832	8-32 Threaded Standoffs

THREADED STANDOFF KITS



Assortment of 425 total pieces. Female-Female standoffs and Male-Female standoffs both aluminum and nylon, with lengths of 10mm, 12mm, 15mm and 20mm.

25 pieces of each size. Complete with cabinet and 25 machine screws with matching threads.

CAT. NO.	KIT SUPPLIED WITH
STR-M3	M3 Threaded Standoffs
STR-M4	M4 Threaded Standoffs

FEMALE-FEMALE STANDOFF KITS



Assortment of 1500 pieces in .250, .375, .500, .750 and 1.000 lengths, with thread sizes of 4-40, 6-32, and 8-32.

100 pieces of each size. Complete with cabinet.

CAT. NO.	KIT SUPPLIED WITH
STR-15	Round Brass Zinc Plated Standoffs
STR-35	Round Aluminum Standoffs with Iridite Finish
STH-14	Hex Brass Zinc Plated Standoffs
STH-22	Hex Aluminum Standoff with Iridite Finish

MALE-FEMALE STANDOFF KITS



Brass kit is an assortment of 750 pieces of .500, .750, 1.000, and 1.500 long standoffs with 4-40, 6-32 and 8-32 thread.

Complete with cabinet.

Stainless kit is an assortment of 250 pieces of .250, .500, .750, and 1.000 long standoffs with 4-40, 6-32 and 8-32 thread.

Complete with cabinet and 25 pieces of each screw size.

CAT. NO.	KIT SUPPLIED WITH
STH-19	Brass-Nickel Plate Standoffs
STH-20	Stainless Steel Standoffs

SELF-RETAINING SPACER ENGINEERING DESIGN KIT



Assortment of 400 total pieces per kit of Self Retaining Round Nylon Spacers. Lengths of .125, .250, .500 and .750

25 pieces of each size/style.
Complete with cabinet.

CAT. NO.	KIT SUPPLIED WITH
SCR-10	#4, #6, #8 & #10 Spacers

CIRCUIT BOARD SPACER/SUPPORT ENGINEERING DESIGN KITS



Assortment of 400 total pieces per kit of a variety of Circuit Board Hardware in .125, .250, .375 and .500 lengths in Nylon 6/6 material.

25 pieces of each size/style.
Complete with cabinet.

CAT. NO.	KIT SUPPLIED WITH
CBH-1	SlimLine Products - Tension Fit; Lock-In, Easy Lock and Single Sided
CBH-2	Lock-In Products - Tension Fit; Lock-In, Easy Lock and Single Sided
CBH-3	Stacking Products - Thru-Hole and Self Aligning

THIS DOCUMENT IS THE PROPERTY OF KEYSTONE ELECTRONICS CORP. AND SHALL NOT BE REPRODUCED, DISTRIBUTED OR USED AS A BASIS FOR MANUFACTURE WITHOUT PRIOR WRITTEN PERMISSION FROM KEYSTONE ELECTRONICS CORP.

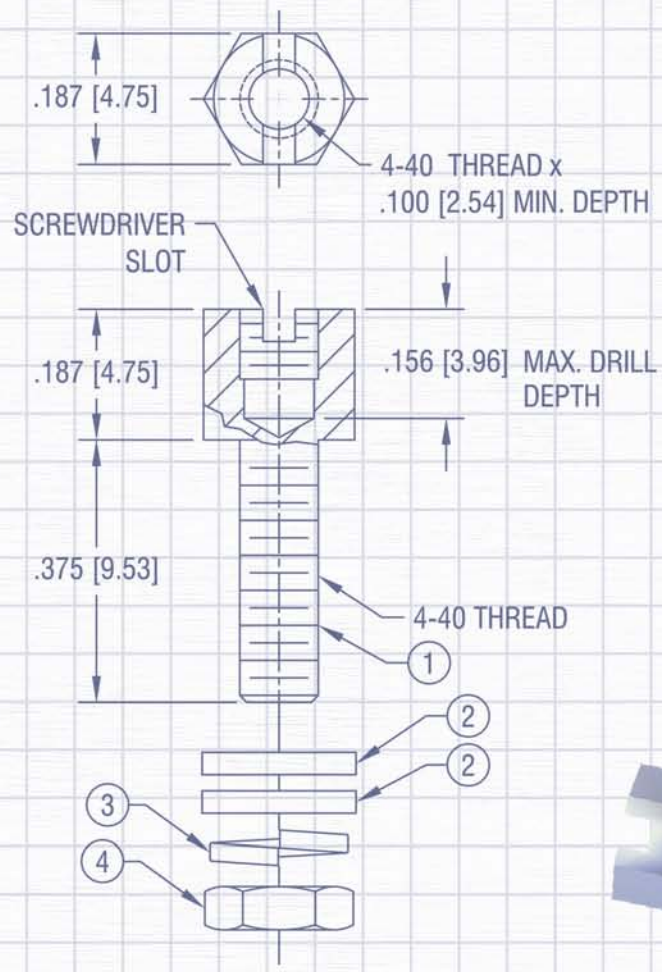
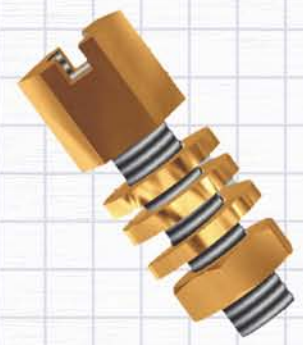

PANEL HARDWARE

Our diverse selection of panel hardware is second to none in the marketplace. Our Handles, Screws, Knobs, Fan Guards and LED lens and mounting spacers provides the right solution for a variety of applications, including:

- Rack Mounted Equipment
- Carrying Cases
- Low Friction Assemblies
- "D" Subminiature connector Hardware
- Instrumentation Panels and Gauges
- Environments where mounting hardware is subject to loss
- For protection from damage or debris
- To dress up chassis access panels, racks or controls

Our quality system is ISO 9001:2008 certified. Our products are in compliance with the RoHS and REACH directives. We provide 3D modeling, CAD and other application-engineering support for modifications, special designs or assembly requirements to assist you in choosing the right Keystone product for your application.

DATE	DESCRIPTION	REV.

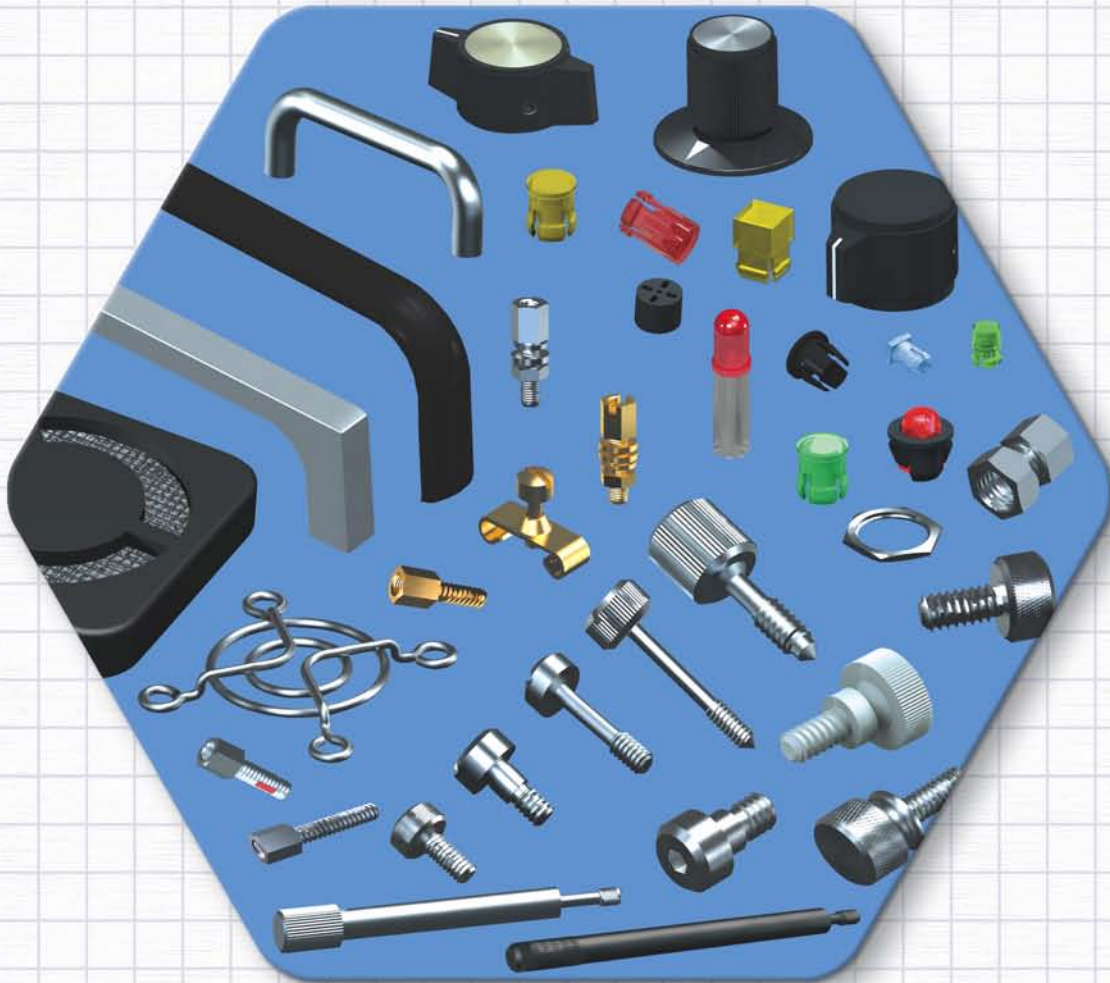

SECTION CONTENTS

FAN FILTERS & GUARDS	88-89	SCREWS	
HANDLES		Panel Mounting	82
Contemporary	86	Jack Screws	82
Ferrules / Screws	87	Captive Panel	83
Instrumentation	86-87	Shoulder	84
KNOBS (INSTRUMENTATION)	85	Thumb	83
LED HARDWARE		MISCELLANEOUS HARDWARE	
Holders	90	Panel Bearing	84
Lens and Caps	90	Panel Nuts	84
Spacers	91	Shaft Coupling	84
INSTRUMENT CASES	85	Shaft Locks	84
		Volume Control Extender	84

JACK SCREWS

- Equivalent to AMP, CANNON & TRW Jack Screws
 - "D" subminiature connector mounting screw
 - Custom lengths available
 - Hardware supplied unassembled and in bulk
- SPECIFICATIONS:** **YELLOW:** Steel, Zinc Plate and Yellow Chromate; **CLEAR:** Steel, Zinc Plate and Clear Chromate; **STAINLESS:** Stainless Steel

STANDARD JACK SCREWS

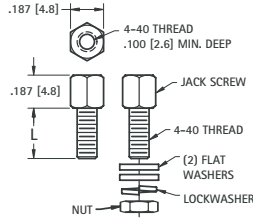

JACK ONLY			L LENGTH	JACK WITH HARDWARE*		
YELLOW CAT. NO.	CLEAR CAT. NO.	STAINLESS CAT. NO.		YELLOW CAT. NO.	CLEAR CAT. NO.	STAINLESS CAT. NO.
7228	7228-5	7248	.250 (6.4)	7229	7229-5	7249
7230	7230-5	7250	.312 (7.9)	7231	7231-5	7251
7241	7241-5	7252	.375 (9.5)	7242	7242-5	7253
7243	7243-5	7254	.500 (12.7)	7244	7244-5	7255
7232	7232-5	7256	.625 (15.8)	7233	7233-5	7257

*Hardware supplied unassembled in bulk

SEMS JACK SCREWS

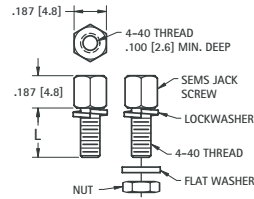

SEMS JACK ONLY		L LENGTH	SEMS JACK WITH HARDWARE*	
CLEAR CAT. NO.	CLEAR CAT. NO.		CLEAR CAT. NO.	CLEAR CAT. NO.
7235	7235	.285 (7.3)	7236	7236
7237	7237	.347 (8.8)	7238	7238
7239	7239	.660 (16.8)	7240	7240

*Hardware supplied unassembled in bulk

SLOTTED JACK SCREWS

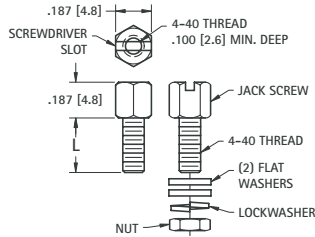

- Slot provides ability to install jack with a screwdriver.

JACK ONLY			L LENGTH	JACK WITH HARDWARE*	
YELLOW CAT. NO.	CLEAR CAT. NO.	CLEAR CAT. NO.		YELLOW CAT. NO.	CLEAR CAT. NO.
7270	7270	7275	.250 (6.3)	7290	7295
7271	7271	7276	.312 (7.9)	7291	7296
7272	7272	7277	.375 (9.5)	7292	7297
7273	7273	7278	.500 (12.7)	7293	7298
7274	7274	7279	.625 (15.8)	7294	7299

*Hardware supplied unassembled in bulk

JACK SCREWS WITH NYLON PATCH

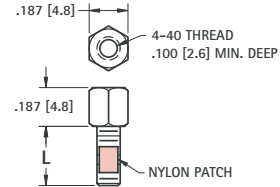

- Nylon patch holds jack firmly in vibration applications.

JACK WITH NYLON PATCH			
YELLOW CAT. NO.	CLEAR CAT. NO.	STAINLESS CAT. NO.	L LENGTH
7260	7261	7262	.250 (6.4)
7263	7264	7265	.312 (7.9)
7266	7267	7268	.375 (9.5)

TURNABLE JACK SCREWS

DIRECT ACCESS

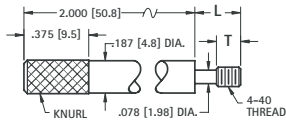

MATERIAL: Steel, Black Oxide

WITHOUT SLOT CAT. NO.	WITH SLOT CAT. NO.	T DIM.	L DIM.
2064	2065	.125 (3.2)	.250 (6.4)
2066	2067	.250 (6.4)	.437 (11.1)

STRAIGHT KNURL

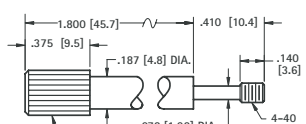

MATERIAL: Steel, Zinc Plate & Clear Chromate

WITHOUT SLOT CAT. NO.	WITH SLOT CAT. NO.
2072	2073

SLIM LINE

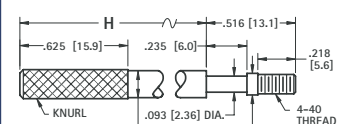

MATERIAL: Steel, Nickel Plate

WITHOUT SLOT CAT. NO.	WITH SLOT CAT. NO.	H DIM.
2068	2069	1.250 (31.8)
2070	2071	1.750 (44.5)

PANEL MOUNTING HARDWARE

"U" CLIP



Supplied Unassembled

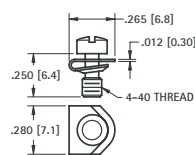

MATERIAL:
Clip & Screw: Steel, Zinc Plate & Yellow Chromate

CAT. NO. 2062

"BOW TIE" RETAINING CLIP



Supplied Unassembled

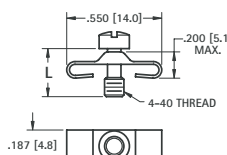

MATERIAL:
Clip & Screw: Steel, Zinc Plate & Yellow Chromate

CAT. NO.	L
2060	.250 (6.4)
2061	.281 (7.1)

SADDLE WASHER



Supplied Unassembled

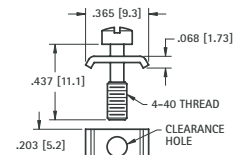

MATERIAL:
Clip & Screw: Steel, Zinc Plate & Yellow Chromate

CAT. NO. 2063

CAPTIVE PANEL SCREWS

MATERIAL: Stainless Steel per ASTM-A581/A-582

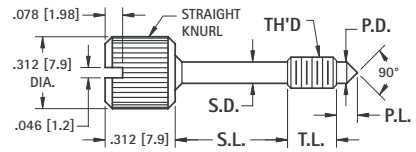
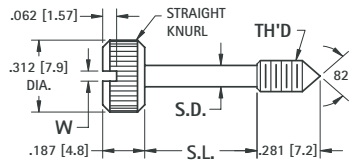

CAT. NO.	THREAD	S.D. ± .005 (.13)	S.L. ± .010 (.25)	W + .015 (+.38) -.000
8700	4-40	.078 (2.0)	.375 (9.5)	.036 (.091)
8701	4-40	.078 (2.0)	.500 (12.7)	.036 (.091)
8702	4-40	.078 (2.0)	.625 (15.9)	.036 (.091)
8703	6-32	.095 (2.41)	.375 (9.5)	.045 (1.14)
8704	6-32	.095 (2.41)	.500 (12.7)	.045 (1.14)
8705	6-32	.095 (2.41)	.625 (15.9)	.045 (1.14)

CAT. NO.	THREAD	T.L. ± .015 (.38)	S.D. ± .005 (.13)	S.L. ± .010 (.25)	P.D. +0.00-.016 (-.40)	P.L. ± .015 (.38)
8706	4-40	.125 (3.2)	.078 (2.0)	.171 (4.3)	.078 (2.0)	.078 (2.0)
8707	4-40	.125 (3.2)	.078 (2.0)	.296 (7.5)	.078 (2.0)	.078 (2.0)
8708	4-40	.125 (3.2)	.078 (2.0)	.421 (10.7)	.078 (2.0)	.078 (2.0)
8709	6-32	.218 (5.5)	.095 (2.41)	.187 (4.7)	.095 (2.41)	.093 (2.36)
8710	6-32	.218 (5.5)	.095 (2.41)	.312 (7.9)	.095 (2.41)	.093 (2.36)
8711	6-32	.218 (5.5)	.095 (2.41)	.437 (11.1)	.095 (2.41)	.093 (2.36)

4-40

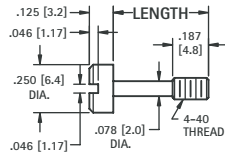

CAT. NO.	LENGTH
2413	.469 (11.9)
2414	.531 (13.4)

6-32

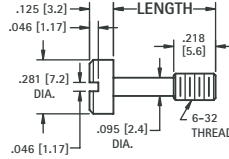
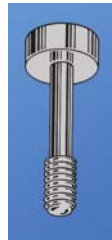

CAT. NO.	LENGTH
2415	.531 (13.5)
2416	.593 (15.1)
2417	.656 (16.7)

8-32

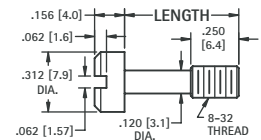
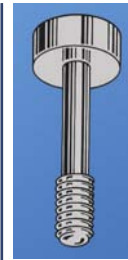

CAT. NO.	LENGTH
2418	.656 (16.7)
2419	.718 (18.2)
2420	.781 (19.8)

THUMB SCREWS

STAINLESS

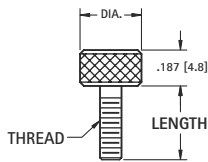
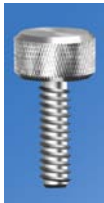

MATERIAL: Stainless Steel

CAT. NO.	LENGTH	THREAD	DIA
2400	.312 (7.9)	4-40	.312 (7.9)
2401	.375 (9.5)		
2402	.437 (11.1)		
2403	.500 (12.7)		
2404	.312 (7.9)	6-32	.312 (7.9)
2405	.375 (9.5)		
2406	.437 (11.1)		
2407	.500 (12.7)		
2408	.375 (9.5)	8-32	.375 (9.5)
2409	.437 (11.1)		
2410	.500 (12.7)		

BRASS

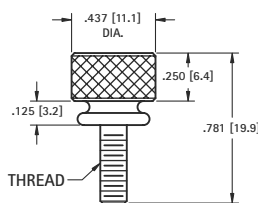

MATERIAL: Brass, Nickel Plate

CAT. NO.	THREAD
1708	6-32
1709	8-32
1710	10-32

NYLON

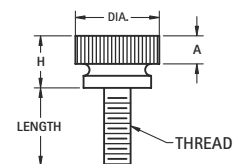

MATERIAL: Nylon 6/6, UL Rated 94V-2

CAT. NO.	LENGTH	THREAD	DIA.	H	A
2500	.250 (6.4)	4-40	.300 (7.6)	.280 (7.1)	.125 (3.2)
2501	.375 (9.5)				
2502	.500 (12.7)				
2503	.250 (6.4)	6-32	.360 (9.1)	.275 (7.0)	.125 (3.2)
2504	.375 (9.5)				
2505	.500 (12.7)				
2506	.250 (6.4)	8-32	.425 (10.8)	.305 (7.7)	.140 (3.6)
2507	.375 (9.5)				
2508	.500 (12.7)				

PRECISION GROUND SHOULDER SCREWS

Shoulder ground to $+.000/-0.001$ Dia, $+.002/-0.000$ Length. **Material:** Stainless Steel, ASTM A581/A582

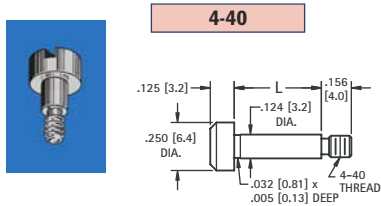

SLOTTED



SOCKET

CAT. NO.	LENGTH	CAT. NO.
2421	.125 (3.2)	2441
2422	.250 (6.4)	2442
2423	.375 (9.5)	2443
2424	.500 (12.7)	2444

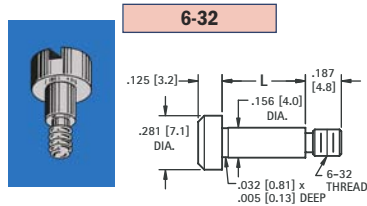

SLOTTED



SOCKET

CAT. NO.	LENGTH	CAT. NO.
2425	.125 (3.2)	2445
2426	.250 (6.4)	2446
2427	.375 (9.5)	2447
2428	.500 (12.7)	2448

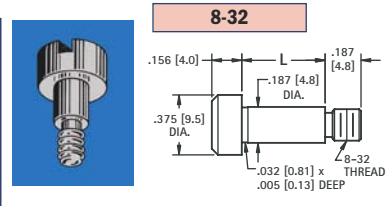

SLOTTED



SOCKET

CAT. NO.	LENGTH	CAT. NO.
2431	.125 (3.2)	2451
2432	.250 (6.4)	2452
2433	.375 (9.5)	2453
2434	.500 (12.7)	2454
2435	.625 (15.9)	2455

SHAFT LOCKS

For .250 (6.4) SHAFT

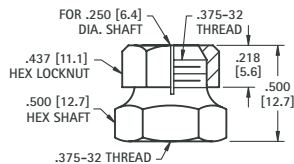

MATERIAL: Brass, Nickel Plate

CAT. NO. 1701

For .250 (6.4) SHAFT

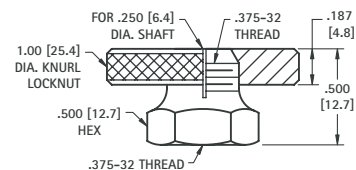
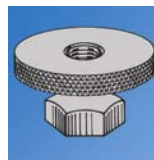

MATERIAL: Brass, Nickel Plate

CAT. NO. 1702

.250 (6.4) SHAFT COUPLING



- Two set screws hold shaft securely

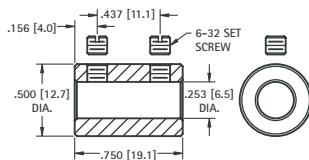

MATERIAL: Brass, Nickel Plate

Set Screws: Steel, Zinc Plate
Supplied unassembled

CAT. NO. 1453

PANEL BEARINGS

STANDARD and MINIATURE

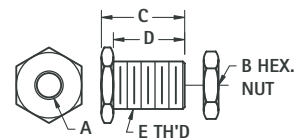

MATERIAL: Brass, Nickel Plate
Supplied unassembled

CAT. NO.	A	B (HEX)	C	D	E THREAD
1705	.253 (6.5)	.437 (11.1)	.500 (12.7)	.437 (11.1)	.375-32 Standard
1706	.128 (3.3)	.343 (8.7)	.437 (11.1)	.375 (9.5)	.250-32 Miniature

VOLUME CONTROL EXTENDERS



For .250 (6.4) volume control shafts having .375-32 threaded bushings.

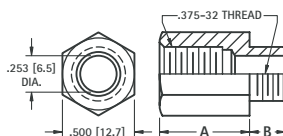

CAT. NO.	A	B
1464	.625 (15.9)	.250 (6.4)
1465	.625 (15.9)	.375 (9.5)
1466	.687 (17.4)	.500 (12.7)
1467	.750 (19.1)	.250 (6.4)

MATERIAL: Brass, Nickel Plate

PANEL NUTS



For Volume Controls, Switches, Tip Jacks, etc.

CAT. NO.	FOR	THREAD	DIAMETER	THICKNESS
1448	Mounting	1/4-32	.375 Hex	.093 (2.38)
1449	Mini. Control	1/4-32	.312 Hex	.078 (1.98)
1456	Vol. Control	3/8-32	.500 Hex	.093 (2.38)
1458	Switch	15/32-32	.562 Hex	.078 (1.98)
1459	Switch Ring	15/32-32	.625 Knurled	.062 (1.57)
1472	Filter	15/16-32	.375 Hex	.093 (2.38)

MATERIAL: Brass, Nickel Plate

PHENOLIC INSTRUMENT CASES

- Choice of Sizes
- Sturdy construction
- Flush mounting panels



- Aluminum or Phenolic Panels Available

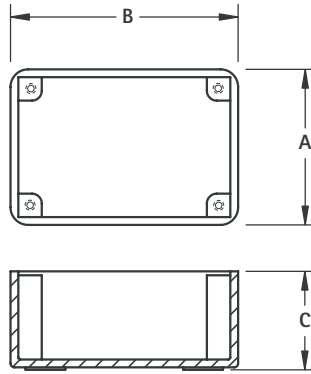

MATERIALS:

Phenolic Panels: .062 (1.57) Glossy Black Phenolic, MIL-P3115C

Aluminum Panels: .062 (1.57), 5052-H34 per QQ 318 C; Bright finished surface with pressure sensitive protective covering tape

MATERIALS:

Phenolic Cases: .125 (3.2) Wall thickness, Molded Glossy Black Phenolic, MIL-M-14, CFG

- Cases and panels are sold separately
- Covers available in Phenolic or Aluminum
- Covers can be machined to accept dials, switches, displays
- Panel mounting screws available - Refer to page 133
- Sturdy case can be machined for wiring access
- Ideal for prototype or lab use

COVER PANEL	
PHENOLIC PANEL	ALUMINUM PANEL
CAT. NO.	CAT. NO.
2050	2051
2042	2044
2042	2044
2043	2045
2037*	2046
2052*	2053
2038*	2047
2039*	2048

*.093 (2.36)

PHENOLIC CASE				
CAT. NO.	A	B	C	THREAD SIZE AND TYPE
715	2.500 (63.5)	3.500 (88.9)	1.250 (31.8)	4-40 TAPPED
703	2.875 (73.0)	4.000 (101.6)	1.562 (39.7)	4-40 TAPPED
705	2.875 (73.0)	4.000 (101.6)	1.562 (39.7)	USE #4 SELF TAPPING SCREW
704	3.125 (79.4)	5.875 (149.2)	2.250 (57.2)	4-40 TAPPED
700	3.750 (95.3)	6.250 (158.8)	2.000 (50.8)	6-32 BRASS INSERT
716	4.250 (108.0)	5.000 (127.0)	1.750 (44.5)	6-32 BRASS INSERT
701	5.250 (133.4)	6.812 (173.0)	2.312 (58.7)	6-32 BRASS INSERT
702	7.375 (187.3)	8.375 (212.7)	3.000 (76.2)	6-32 BRASS INSERT

INSTRUMENTATION KNOBS

- All knobs supplied with two set screws installed

SPECIFICATIONS Knob: ABS Inlay: Spun Aluminum Insert: Brass, Nickel Plate		CAT. NO.	SHAFT (DIA.)	D (DIA.)	H (HEIGHT)	M (MAX.)	SHAFT ATTACHMENT DETAILS		NUT CLEARANCE	
							L (LOCATION)	B (DEPTH)	I.D. (DIA.)	C (C'BORE DEPTH)
		8554	.125 (3.2)	.500 (12.7)	.660 (16.8)	-	.320 (8.1)	.570 (14.5)	.360 (9.1)	.170 (4.3)
		8555	.250 (6.4)	.700 (17.8)	.780 (19.8)	-	.360 (9.1)	.680 (17.3)	.500 (12.7)	.180 (4.6)
		8556	.250 (6.4)	.920 (23.4)	1.010 (25.7)	-	.460 (11.7)	.910 (23.1)	.640 (16.3)	.330 (8.4)
		8557	.250 (6.4)	1.250 (31.8)	.828 (21.0)	-	.400 (10.2)	.700 (17.8)	1.010 (25.7)	.250 (6.4)
		8558	.125 (3.2)	.500 (12.7)	.660 (16.8)	.915 (23.4)	.320 (8.1)	.570 (14.5)	.360 (9.1)	.170 (4.3)
		8559	.250 (6.4)	.700 (17.8)	.780 (19.8)	1.150 (29.2)	.357 (9.1)	.660 (16.7)	.480 (12.2)	.180 (4.6)
		8560	.250 (6.4)	.920 (23.4)	1.010 (25.7)	1.520 (38.6)	.500 (12.7)	.910 (23.1)	.640 (16.3)	.240 (6.1)
		8561	.250 (6.4)	1.250 (31.8)	.920 (23.4)	1.860 (47.2)	.470 (11.9)	.800 (20.3)	.780 (19.8)	.350 (8.9)
		8567	.125 (3.2)	.500 (12.7)	.500 (12.7)	.610 (15.5)	.160 (4.0)	.405 (10.3)	.410 (10.4)	.030 (0.8)
		8568	.250 (6.4)	.700 (17.8)	.625 (15.9)	.820 (20.8)	.210 (5.3)	.480 (12.2)	.468 (11.9)	.030 (0.8)
		8569	.250 (6.4)	.920 (23.4)	.780 (19.8)	1.090 (27.7)	.240 (6.1)	.660 (16.8)	.640 (16.3)	.100 (2.5)
		8565	.250 (6.4)	.700 (17.8)	.630 (16.0)	1.187 (30.2)	.210 (5.3)	.510 (13.0)	.570 (14.5)	.030 (0.8)
		8566	.250 (6.4)	.920 (23.4)	.640 (16.3)	1.510 (38.6)	.260 (6.6)	.540 (13.7)	.730 (18.5)	.120 (3.1)

CARRYING HANDLES



This retractable handle is manufactured with black leather-like material and Nickel Plated steel hardware. Handle folds flat when not in use. Mounts with #6 screws (not supplied).

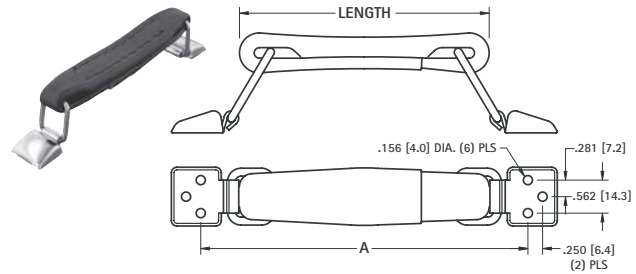

CAT. NO.	LENGTH	A
8351	4.500 (114.3)	6.000 (152.4)
8352	5.500 (139.7)	7.000 (177.8)
8353	6.000 (152.4)	7.500 (190.5)

Folds flat on case when not in use. Mounts with rivets or #6 screws (not supplied).

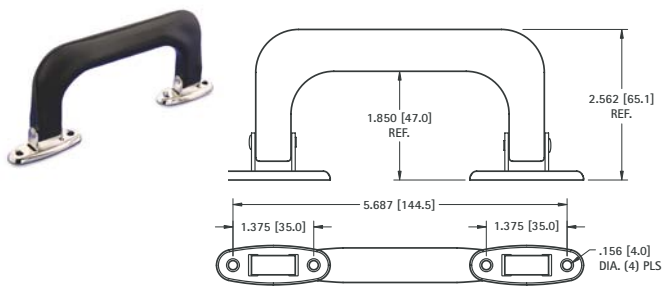

CAT. NO.	COLOR
8356	BLACK

MATERIAL:
Grip: Polypropylene, Black
Post: Steel, Nickel Plate
Pin: Steel, Nickel Plate

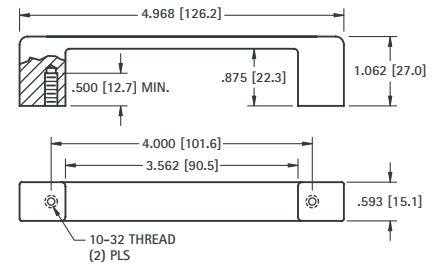

CAT. NO. 7196

MATERIAL: Zinc, Satin Brushed, Nickel Plate

OVAL INSTRUMENTATION HANDLES

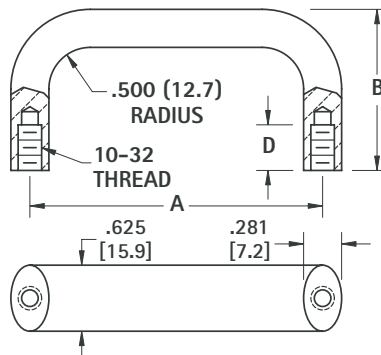

MATERIAL:
Aluminum: QQ-A-200, Alloy 6061-T6, Black Anodized per MIL-A-8625

ALUMINUM CAT. NO.	A MTG. CTRS.	B HEIGHT	D DEPTH	
7186	4.000 (101.6)	1.750 (44.5)	.500 (12.7)	
544	4.000 (101.6)	2.000 (50.8)		
540	4.500 (114.3)	1.750 (44.5)		
545	4.500 (114.3)	2.000 (50.8)		
541	5.000 (127.0)	1.750 (44.5)		
546	5.000 (127.0)	2.000 (50.8)		
542	5.500 (139.7)	1.750 (44.5)		
547	5.500 (139.7)	2.000 (50.8)		
7187	6.000 (152.4)	1.375 (34.9)		.375 (9.5)
543	6.000 (152.4)	1.750 (44.5)		.500 (12.7)
548	6.000 (152.4)	2.000 (50.8)		
7188	6.437 (163.5)	1.750 (44.5)		

CUSTOM HANDLES

Keystone is fully integrated to meet your total design and production needs. Our specialty is manufacturing custom designs and modifications of standard items. Forward your CAD drawing or print to our Engineering Department for a quote on your specific production requirements or visit our "Part Builder" at www.keyelco.com

ROUND INSTRUMENTATION HANDLES



CHOICE of BRASS or ALUMINUM

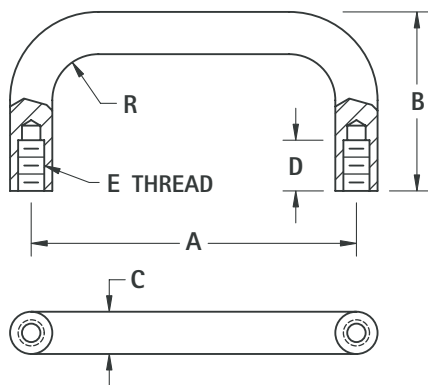

MATERIAL:

Brass: ASTM-B16, Nickel Plate

Aluminum: QQ-A-200, Alloy 6061-T6,

Black Anodized per MIL-A-8625

BRASS CAT. NO.	ALUMINUM CAT. NO.	A MTG. CTRS.	B HEIGHT	D DEPTH	E THREAD	R RADIUS	C DIAMETER				
7140	7170	1.250 (31.8)	1.000 (25.4)	.375 (9.5)	4-40	.156 (4.0)	.156 (4.0)				
7141	7171	2.000 (50.8)	1.000 (25.4)								
7142	7172	3.000 (76.2)	1.000 (25.4)								
9100	9110	1.250 (31.8)	.625 (15.9)	.156 (4.0)	4-40	.187 (4.7)	.187 (4.7)				
9101	9111	1.500 (38.1)	.625 (15.9)								
9104	9114	1.500 (38.1)	.750 (19.1)								
9102	9112	1.750 (44.5)	.625 (15.9)								
9105	9115	1.750 (44.5)	.750 (19.1)								
9103	9113	2.000 (50.8)	.625 (15.9)								
9106	9116	1.250 (31.8)	1.000 (25.4)					.250 (6.4)	6-32	.187 (4.7)	.187 (4.7)
9107	9117	1.500 (38.1)	1.000 (25.4)								
9108	9118	2.000 (50.8)	1.000 (25.4)								
9109	9119	3.000 (76.2)	1.000 (25.4)								
7143	7173	3.000 (76.2)	1.500 (38.1)	.562 (14.3)	8-32	.250 (6.4)	.250 (6.4)				
485	515	3.000 (76.2)	1.750 (44.5)								
480	510	3.500 (88.9)	1.500 (38.1)								
7144	7174	4.000 (101.6)	1.500 (38.1)								
486	516	4.000 (101.6)	1.750 (44.5)								
481	511	4.500 (114.3)	1.500 (38.1)								
487	517	4.500 (114.3)	1.750 (44.5)								
482	512	5.000 (127.0)	1.500 (38.1)								
488	518	5.000 (127.0)	1.750 (44.5)								
483	513	5.500 (139.7)	1.500 (38.1)								
484	514	6.000 (152.4)	1.500 (38.1)								
489	519	6.000 (152.4)	1.750 (44.5)								
7145	7175	3.000 (76.2)	1.500 (38.1)					.562 (14.3)	10-32	.312 (7.9)	.312 (7.9)
7146	7176	4.000 (101.6)	1.500 (38.1)								
493	523	4.000 (101.6)	1.750 (44.5)								
490	520	4.500 (114.3)	1.500 (38.1)								
494	524	4.500 (114.3)	1.750 (44.5)								
7147	7177	4.562 (115.9)	1.500 (38.1)								
491	521	5.000 (127.0)	1.500 (38.1)								
495	525	5.000 (127.0)	1.750 (44.5)								
492	522	5.500 (139.7)	1.500 (38.1)								
7148	7178	6.000 (152.4)	1.500 (38.1)								
496	526	6.000 (152.4)	1.750 (44.5)								
7149	7179	6.437 (163.5)	1.750 (44.5)								
7150	7180	4.000 (101.6)	1.375 (34.9)	.375 (9.5)	10-32	.375 (9.5)	.375 (9.5)				
7151	7181	6.000 (152.4)	1.375 (34.9)								

FERRULES

FERRULES FOR ROUND HANDLES

- To protect and support panel surface

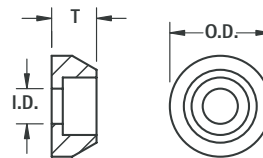

MATERIAL:

Brass: ASTM-B16, Nickel Plate

Aluminum: QQ-A-200, Alloy 6061-T6, Black Anodized per MIL-A-8625

BRASS CAT. NO.	ALUMINUM CAT. NO.	FOR THREAD	FOR DIAMETER	O.D.	I.D.	T
7162	7192	4-40	.156 (4.0)	.250 (6.4)	.120 (3.0)	.125 (3.2)
9120	9122	4-40	.187 (4.7)	.312 (7.9)	.120 (3.0)	.125 (3.2)
9121	9123	6-32	.187 (4.7)	.312 (7.9)	.144 (3.7)	.125 (3.2)
7163	7193	8-32	.250 (6.4)	.375 (9.5)	.170 (4.3)	.187 (4.7)
7164	7194	10-32	.312 (7.9)	.562 (14.3)	.196 (5.0)	.250 (6.4)

HANDLE MOUNTING SCREWS

- Phillips drive pan head machine screws

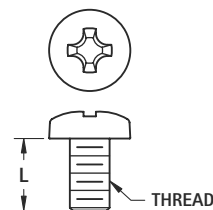

MATERIAL: Stainless Steel

CAT. NO.	L LENGTH	THREAD	DRIVER SIZE
9900	.250 (6.4)	4-40	1
9901	.375 (9.5)		
9902	.500 (12.7)		
9903	.250 (6.4)	6-32	2
9904	.375 (9.5)		
9905	.500 (12.7)		
9906	.375 (9.5)	8-32	2
9907	.500 (12.7)		
9908	.750 (19.1)		
9909	.375 (9.5)	10-32	2
9910	.500 (12.7)		
9911	.750 (19.1)		

PLASTIC FAN FILTER ASSEMBLY

A unique package consisting of guard, filter media and retainer. The guard and retainer are manufactured with UL Rated 94V-HB material. The filter media is made of polyester foam and aluminum mesh which allows free passage of air (24 CFM) with minimum air resistance and pressure drop. A major feature of this assembly is that when the filter media requires maintenance you simply remove the snap-fit retainer to clean or replace the filter, leaving the guard and fan in place. This assures protection to the fan blades and eliminates damage to the fan or equipment during cleaning.

RETAINER

MATERIAL: Glass filled Nylon 6/6, UL Rated HB

- Snap-fit construction
- Designed for minimum air restriction

MEDIA

MATERIAL: White Polyester foam and Aluminum screen

- Constructed to allow free passage of air with minimum resistance and pressure drop (24 CFM)
- Has a high surface-area contact for impingement of dust particles
- Helps reduce external fan noise
- Easily cleaned by vacuuming or washing with mild soap, detergent or cleaning solvent
- Replacement media available

GUARD

MATERIAL: Glass filled Nylon 6/6, UL Rated HB

- .250 (6.4) maximum ring spacing
- Decreased noise level
- Countersunk mounting holes (4)
- Withstands high impact

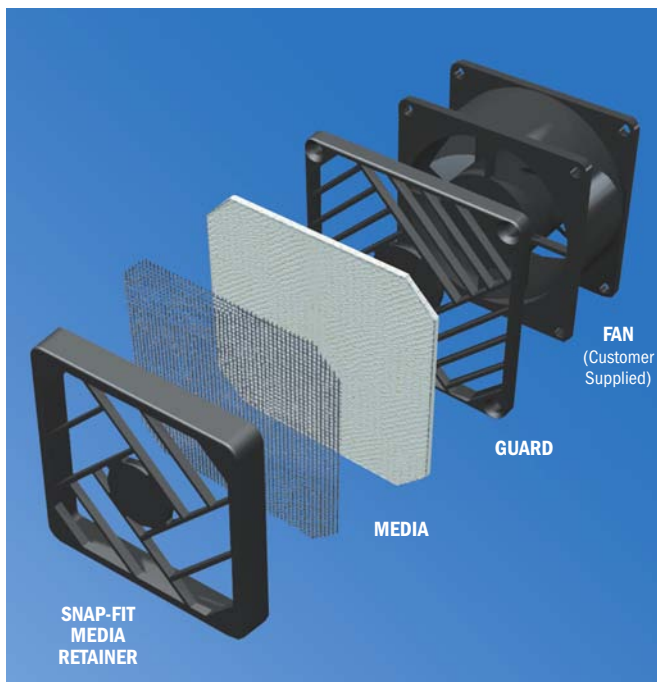

FAN GUARD & FILTER ASSEMBLIES

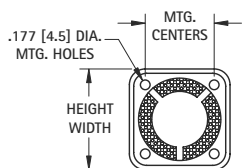

Fig. 1

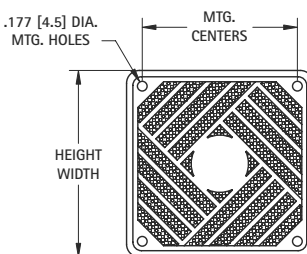

Fig. 2

ASSEMBLY CAT. NO.	FIG. NO.	FOR FAN SIZE	HEIGHT/WIDTH	THICKNESS	MTG. CENTERS	FILTER MEDIA ONLY CAT. NO.
8443	1	1.50 (40mm)	1.839 (46.7)	.327 (8.3)	1.260 (32.0)	8443-MO
8444	2	2.50 (60mm)	2.559 (65.0)	.488 (12.4)	1.970 (50.0)	8444-MO
8487	2	3.12 (80mm)	3.408 (86.7)	.488 (12.4)	2.840 (72.0)	8487-MO
8488	2	3.62 (92mm)	3.815 (96.9)	.488 (12.4)	3.250 (82.5)	8488-MO
8489	2	4.50 (120mm)	4.961 (126.0)	.496 (12.6)	4.130 (105.0)	8489-MO

FAN GUARDS

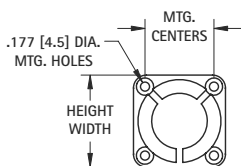

Fig. 3

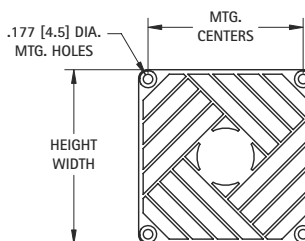

Fig. 4

GUARD CAT. NO.	FIG. NO.	FOR FAN SIZE	HEIGHT/WIDTH	THICKNESS	MTG. HOLE CENTER SPACING
8445	3	1.50 (40mm)	1.681 (42.7)	.169 (4.3)	1.260 (32.0)
8446	4	2.50 (60mm)	2.378 (60.4)	.236 (6.0)	1.970 (50.0)
8497	4	3.12 (80mm)	3.177 (80.7)	.236 (6.0)	2.840 (72.0)
8498	4	3.62 (92mm)	3.634 (92.3)	.236 (6.0)	3.250 (82.5)
8499	4	4.50 (120mm)	4.741 (120.4)	.244 (6.2)	4.130 (105.0)

METAL GUARDS

Made of high quality steel wire which combines strength with superior forming. The units offer clean, strong butt welds with minimum flash and have consistent guard diameters to enhance maximum air-flow and venting.

- Available for most popular size fans
- Protects fingers as well as fan blades
- Same mounting hole pattern as standard fans
- Chrome Plate offers a high luster finish

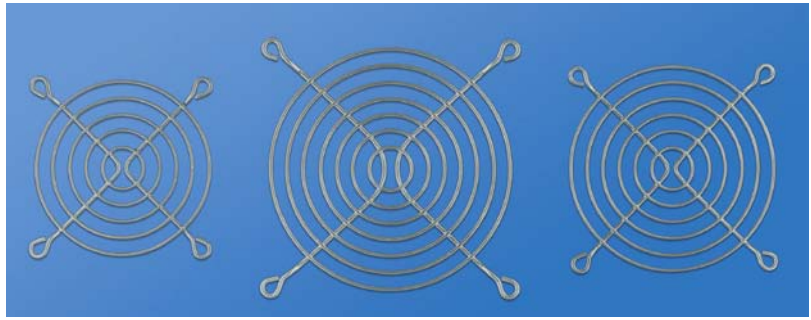

MATERIAL: Steel, Nickel Chrome Plate

FITS 1.50" (40mm) FANS

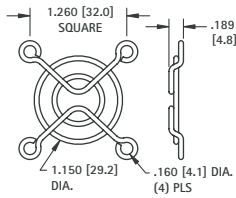

CONSTRUCTION

Rings: .063 (1.60) wire diameter
Ribs: .063 (1.60) wire diameter

CAT. NO. 8447

FITS 2.50" (60mm) FANS

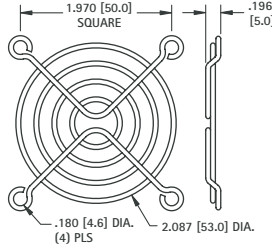

CONSTRUCTION

Rings: .063 (1.60) wire diameter
Ribs: .063 (1.60) wire diameter

CAT. NO. 8449

FITS 3.12" (80mm) FANS

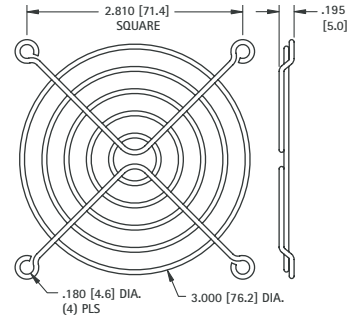

CONSTRUCTION

Rings: .063 (1.60) wire diameter
Ribs: .063 (1.60) wire diameter

CAT. NO. 8450

FITS 3.62" (92mm) FANS

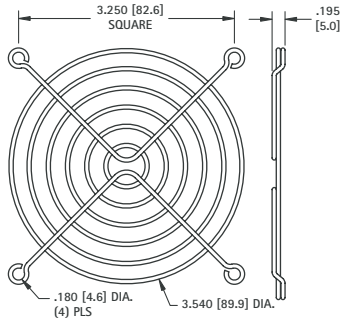

CONSTRUCTION

Rings: .063 (1.60) wire diameter
Ribs: .063 (1.60) wire diameter

CAT. NO. 8451

FITS 4.50" (120mm) FANS

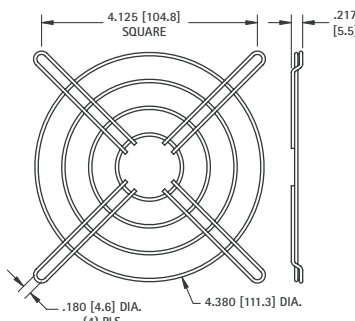

CONSTRUCTION

Rings: .063 (1.60) wire diameter
Ribs: .063 (1.60) wire diameter

CAT. NO. 8448

FITS 4.50" (120mm) FANS

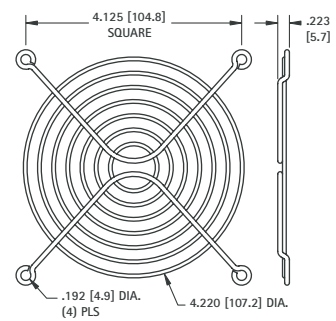

CONSTRUCTION

Rings: .071 (1.80) wire diameter
Ribs: .091 (2.31) wire diameter

CAT. NO. 8452

FITS 4.50" (120mm) FANS

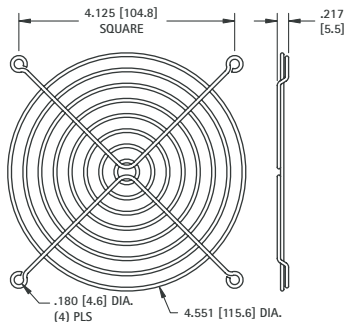

CONSTRUCTION

Rings: .071 (1.80) wire diameter
Ribs: .071 (1.80) wire diameter

CAT. NO. 8453

FITS 6.00" (150mm) FANS

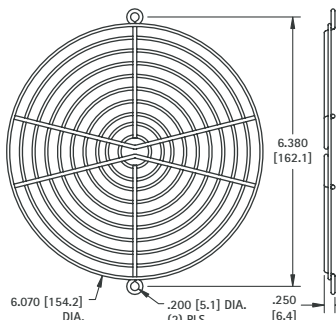

CONSTRUCTION

Rings: .071 (1.80) wire diameter
Ribs: .091 (2.31) wire diameter

CAT. NO. 8455

FITS 10.00" (250mm) FANS

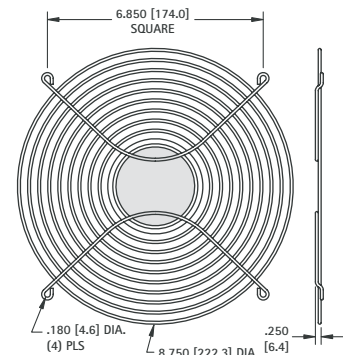

CONSTRUCTION

Rings: .091 (2.31) wire diameter
Ribs: .091 (2.31) wire diameter

CAT. NO. 8457

LED LENS CAPS

Designed for use with T-1 or T-1 3/4 LEDs, these Lens Caps are available in round or square configurations. They snap-mount through the front panel for easy, light-finger pressure, installation. The LED is inserted into the cap from behind the panel and held securely in place.

The Lens Cap protects the LED from physical damage while guarding the components from electrostatic discharge (ESD), up to 16KV. More economical than indicator light assemblies, the caps feature striated lines and fresnel rings which permit up to 180 viewing angles with either diffused or non-diffused LED's. They provide exceptionally high contrast and visibility.



MATERIAL: Polycarbonate
Available in Red, Green, Yellow and Clear

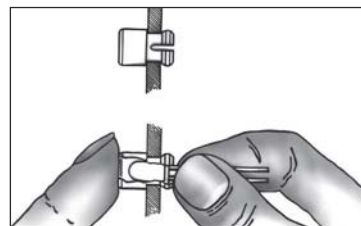

ROUND CAPS

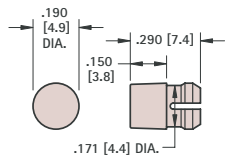

FIG. 1 T-1

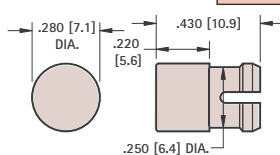

FIG. 2 T-1 3/4

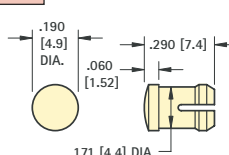

FIG. 3 T-1

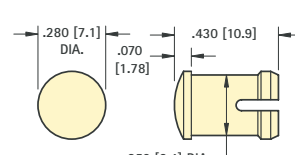

FIG. 4 T-1 3/4

STANDARD HEIGHT

CAT. NO.	COLOR	FIG. NO.	LED SIZE	MTG. HOLE SIZE	MIN. MTG. CENTERS	PANEL THICKNESS
8650	RED	1	T-1	.171 (4.3)	.250 (6.4)	.031 - .062 (.79/1.57)
8651	GREEN					
8652	YELLOW					
8653	CLEAR	2	T-1 3/4	.250 (6.4)	.375 (9.5)	.062 - .125 (1.57/3.18)
8662	RED					
8663	GREEN					
8664	YELLOW					
8665	CLEAR					

LOW PROFILE

CAT. NO.	COLOR	FIG. NO.	LED SIZE	MTG. HOLE SIZE	MIN. MTG. CENTERS	PANEL THICKNESS
8656	RED	3	T-1	.171 (4.3)	.250 (6.4)	.062 - .125 (1.57/3.18)
8657	GREEN					
8658	YELLOW					
8659	CLEAR	4	T-1 3/4	.250 (6.4)	.375 (9.5)	.031 - .250 (.79/6.4) (See Note)
8668	RED					
8669	GREEN					
8670	YELLOW					
8671	CLEAR					

SQUARE CAPS

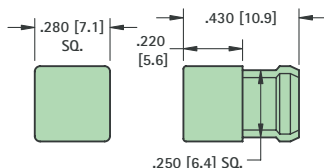

FIG. 5 T-1 3/4

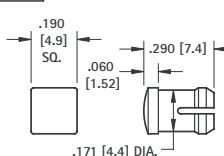

FIG. 6 T-1

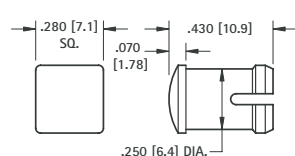

FIG. 7 T-1 3/4

STANDARD HEIGHT

CAT. NO.	COLOR	FIG. NO.	LED SIZE	MTG. HOLE SIZE	MIN. MTG. CENTERS	PANEL THICKNESS
8680	RED	5	T-1 3/4	.250 (6.4) SQUARE	.375 (9.5)	.062 - .125 (1.57/3.18)
8681	GREEN					
8682	YELLOW					
8683	CLEAR					

LOW PROFILE

CAT. NO.	COLOR	FIG. NO.	LED SIZE	MTG. HOLE SIZE	MIN. MTG. CENTERS	PANEL THICKNESS
8674	RED	6	T-1	.171 (4.3)	.250 (6.4)	.062 - .125 (1.57/3.18)
8675	GREEN					
8676	YELLOW					
8677	CLEAR	7	T-1 3/4	.250 (6.4)	.375 (9.5)	.031 - .250 (.79/6.4) (See Note)
8686	RED					
8687	GREEN					
8688	YELLOW					
8689	CLEAR					

Note: When mounting T-1 3/4 Low Profile Caps (Fig. 4 or Fig. 7) in panels .125 (3.2) thick or less a spacer must be used. **Spacer CAT. NO. 8692 MATERIAL:** White Nylon .360 (9.1) O.D. x 1/4 I.D. x 1/8 Lg.

"SNAP-IN" T-1 & T-1 3/4 LED HOLDERS

Designed for use with T-1 or T-1 3/4 LED's in .060 (1.52) - .070 (1.78) thick panels. The holder snaps into the front panel with easy, light-finger pressure. The LED snaps into the holder from behind the panel and is held securely in place.



MATERIAL: Nylon 6/6, Black

CAT. NO.	LED SIZE	A	B	C	MTG. HOLE SIZE
8309	T-1	.114 (2.9)	.232 (5.9)	.188 (4.8)	.171 (4.3)
8310	T-1 3/4	.200 (5.0)	.315 (8.0)	.274 (6.9)	.250 (6.4)

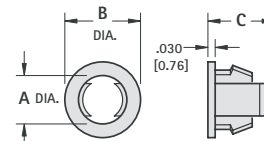
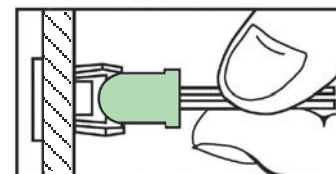

"UNIVERSAL" FOR T-1 & T-1 3/4

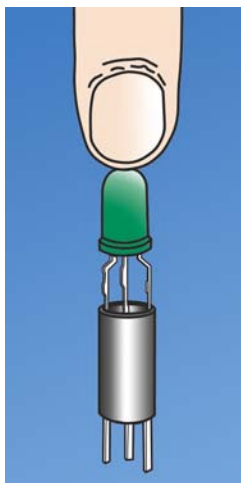

- Unique design separates leads and retains Tri-Lead and Bi-Lead components.
- Designed for PC board mounting of Tri-Lead and Bi-Lead T-1 and T-1 3/4 LEDs
- Provides height control, lead retention and stability.
- Also suitable for mounting lamps, resistors, transistors, diodes, capacitors, etc.

MATERIAL: Black PVC, UL Rated 94V-0

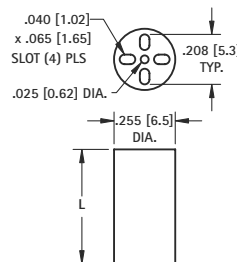

FOR T-1 3/4 and T-1			
CAT. NO.	L LENGTH	CAT. NO.	L LENGTH
8900	.120 (3.0)	8916	.400 (10.2)
8901	.140 (3.6)	8917	.420 (10.7)
8902	.160 (4.1)	8918	.440 (11.2)
8903	.180 (4.6)	8919	.450 (11.4)
8904	.200 (5.1)	8920	.460 (11.7)
8905	.220 (5.6)	8921	.480 (12.2)
8906	.240 (6.1)	8922	.500 (12.7)
8907	.250 (6.4)	8923	.550 (14.0)
8908	.260 (6.6)	8924	.600 (15.2)
8909	.280 (7.1)	8925	.650 (16.5)
8910	.300 (7.6)	8926	.700 (17.8)
8911	.320 (8.1)	8927	.750 (19.1)
8912	.340 (8.6)	8928	.800 (20.3)
8913	.350 (8.9)	8929	.850 (21.6)
8914	.360 (9.1)	8930	.900 (22.9)
8915	.380 (9.7)	8931	.925 (23.5)

"SELF-ALIGNING" FOR BI-LEAD T-1 & T-1 3/4

KEY FEATURES

- Positive self-alignment of leads on .100 (.25) centers.
- No special tools required

MATERIAL: Natural Nylon, UL Rated 94V-2

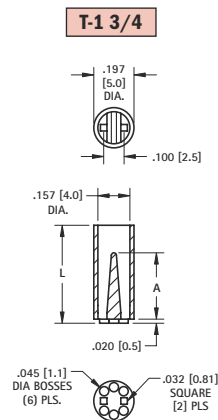
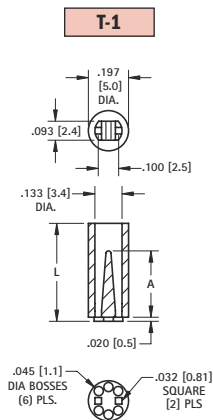
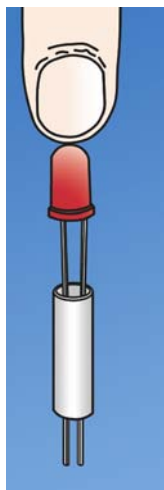

- This features an internally tapered barrier which guides the leads and eliminates crimping or shorting.
- The bottom bosses serve the dual purpose of heat dissipation and easy post soldering cleanup.

T-1 3/4	T-1	L LENGTH	A REF.	T-1 3/4	T-1	L LENGTH	A REF.
8311	7351	.120 (3.0)	.075 (1.9)	8327	7367	.400 (10.2)	.325 (8.3)
8312	7352	.140 (3.6)		8328	7368	.420 (10.7)	
8313	7353	.160 (4.1)		8329	7369	.440 (11.2)	
8314	7354	.180 (4.6)		8330	7370	.450 (11.4)	
8315	7355	.200 (5.1)		8331	7371	.460 (11.7)	
8316	7356	.220 (5.6)	.190 (4.8)	8332	7372	.480 (12.2)	.450 (11.4)
8317	7357	.240 (6.1)		8333	7373	.500 (12.7)	
8318	7358	.250 (6.4)		8334	7374	.550 (14.0)	
8319	7359	.260 (6.6)		8335	7375	.600 (15.2)	
8320	7360	.280 (7.1)		8336	7376	.650 (16.5)	
8321	7361	.300 (7.6)	.200 (5.1)	8337	7377	.700 (17.8)	.575 (14.6)
8322	7362	.320 (8.1)		8338	7378	.750 (19.1)	
8323	7363	.340 (8.6)		8339	7379	.800 (20.3)	
8324	7364	.350 (8.9)		8340	7380	.850 (21.6)	
8325	7365	.360 (9.1)		8341	7381	.900 (22.9)	
8326	7366	.380 (9.7)	.325 (8.3)	8342	7382	.925 (23.5)	

"SELF-RETAINING" FOR T-1

- Features internal retention "teeth" which secure LED leads onto spacers.
- This features an internally tapered barrier which guides the leads and eliminates crimping or shorting.
- The bottom bosses serve the dual purpose of heat dissipation and easy post soldering cleanup.

MATERIAL: Natural Nylon, UL Rated 94V-2

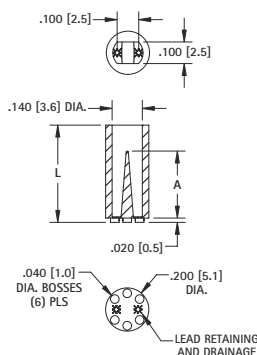
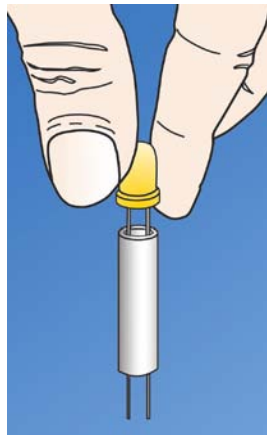

KEY FEATURES

- Internal design eliminates crimping or shorting of leads
- Self alignment of leads on .100 (.25) centers.
- Spacer will stay gripped to LED leads during assembly
- No special tools required

T-1	CAT. NO.	L LENGTH	A REF.	T-1	CAT. NO.	L LENGTH	A REF.
	7030	.120 (3.0)	.060 (1.5)		7046	.400 (10.2)	.310 (7.9)
	7031	.140 (3.6)		7047	.420 (10.7)		
	7032	.160 (4.1)		7048	.440 (11.2)		
	7033	.180 (4.6)		7049	.450 (11.4)		
	7034	.200 (5.1)		7050	.460 (11.7)		
	7035	.220 (5.6)	.185 (4.7)		7051	.480 (12.2)	.435 (11.0)
	7036	.240 (6.1)		7052	.500 (12.7)		
	7037	.250 (6.4)		7053	.550 (14.0)		
	7038	.260 (6.6)		7054	.600 (15.2)		
	7039	.280 (7.1)		7055	.650 (16.5)		
	7040	.300 (7.6)	.185 (4.7)		7056	.700 (17.8)	.650 (14.2)
	7041	.320 (8.1)		7057	.750 (19.1)		
	7042	.340 (8.6)		7058	.800 (20.3)		
	7043	.350 (8.9)		7059	.850 (21.6)		
	7044	.360 (9.1)		7060	.900 (22.9)		
	7045	.380 (9.7)	.310 (7.9)	7061	.925 (23.5)		

THIS DOCUMENT IS THE PROPERTY OF KEYSTONE ELECTRONICS CORP. AND SHALL NOT BE REPRODUCED, DISTRIBUTED OR USED AS A BASIS FOR MANUFACTURE WITHOUT PRIOR WRITTEN PERMISSION FROM KEYSTONE ELECTRONICS CORP.

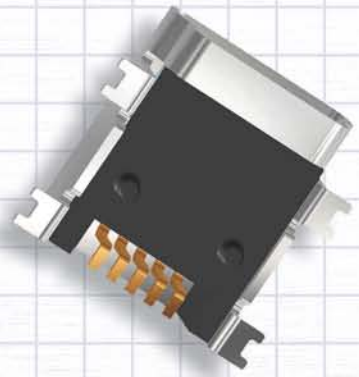
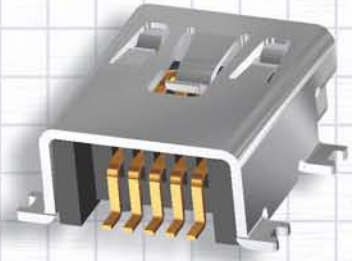
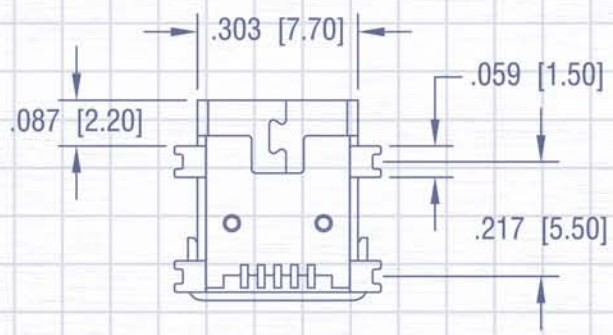
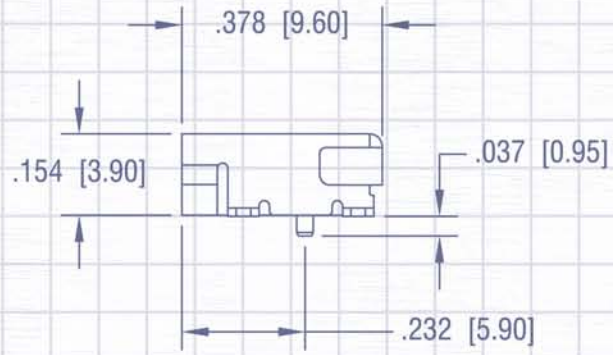
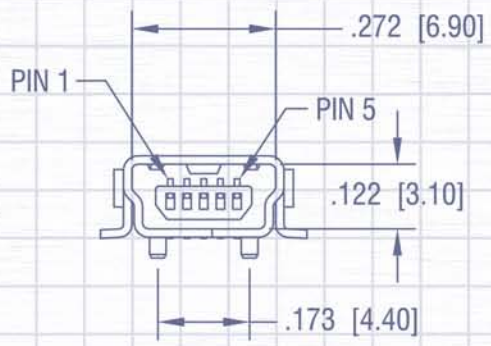

PINS, PLUGS, JACKS & HARDWARE

Our PCB pins & receptacles, solder terminals, tip, test, banana and binding post receptacles & terminals, and USB connectors and sockets offer the most versatility for virtually any device requirements such as:

- Audio Circuitry
- Home theaters
- Electronic test equipment
- Telephone switchboards
- High Speed computer connections
- Telecommunication hook ups
- CATV equipment hook ups

Our quality system is ISO 9001:2008 certified. Our products are in compliance with the RoHS and REACH directives. We provide 3D modeling, CAD and other application-engineering support for modifications, special designs or assembly requirements to assist you in choosing the right Keystone product for your application.

DATE	DESCRIPTION	REV.



SECTION CONTENTS

JACKS AND PLUGS

Audio Jacks 108
 Banana Jacks/Plugs 106-107
 Binding Posts 108
 Phono Jacks & Plugs 102-103
 Test Jacks/Plugs 104-105

MICRO PINS / JACKS

Micro Jacks 98-99
 Micro Pins 100-101
 Shorting Jacks & Pins 101

SOCKET, HALOGEN LAMP 110

TRANSISTOR

Sockets 110-111
 Mounting Kits 109-111
 Mica Insulators 109
 TO-3 Covers 110

USB JACKS AND PLUGS

2.0 A and B-Type 94-95
 3.0 A and B-Type 96
 Firewire, IEEE 1394 97

USB 2.0 PLUGS & SOCKETS

SOCKET SPECIFICATIONS:

Shell: Phosphor Bronze
Insulator: Thermoplastic, UL Rated 94V-0
Contacts: Phosphor Bronze
Contact Area: Gold Flash over Nickel
Solder Trails: Tin over Nickel

PLUG SPECIFICATIONS:

Shell: Steel, Nickel Plate
Insulator: Thermoplastic, Rated UL 94V-0
Contact: Bronze, Gold Flash over Nickel

ELECTRICAL CHARACTERISTICS

Rated Voltage: 30V (RMS)
Contact Current Rating: 1 Amp DC max.
Contact Resistance: 15 mΩ max.
Insulation Resistance: 1000 mΩ min.
Dielectric Withstanding Voltage: 750V AC for 1 minute

MECHANICAL CHARACTERISTICS

Operating Temperature: -13°F (-25°C) to +176°F (+80°C)
Durability: 1500 Cycles min.

DEVICE APPLICATIONS

- Ability to daisy chain more than one input device
- Mouse/Keyboards
 - MP3 Players
 - Printers/Scanners
 - Digital Cameras/Video
 - Memory Sticks
 - PDAs and Cell Phones

TYPE A SOCKETS

SURFACE MOUNT

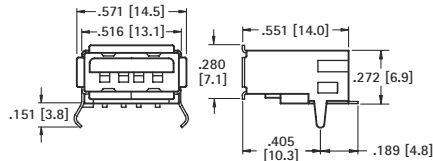

HORIZONTAL

THRU HOLE MOUNT

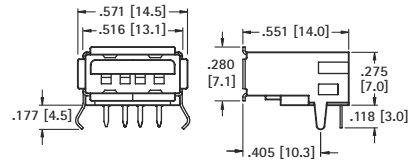

VERTICAL

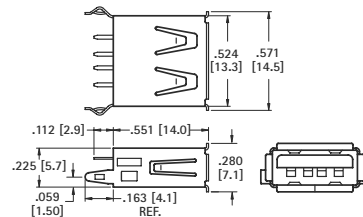

DUAL STACKING

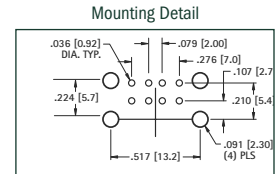
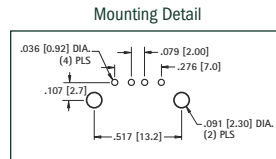
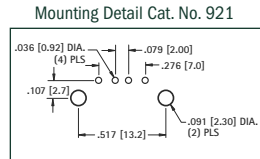
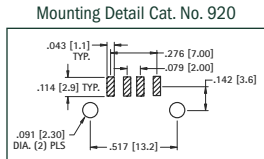
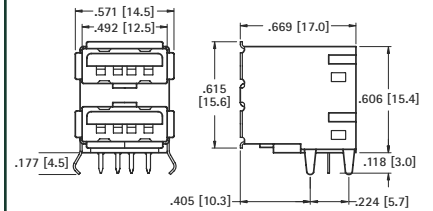

CAT. NO. 920

CAT. NO. 921

CAT. NO. 923

CAT. NO. 922

TYPE A PLUGS

FEATURES

- Available for on-board applications such as memory sticks
- Cable clamp style for creating custom cables
- Gold plated contacts for low contact resistance and excellent reliability

SURFACE MOUNT

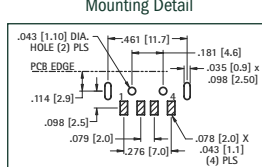
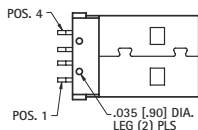
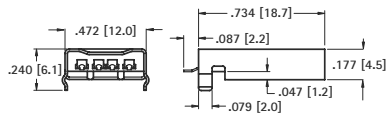

CAT. NO. 931

THRU HOLE MOUNT

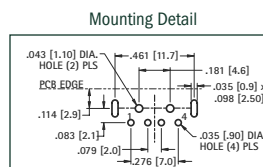
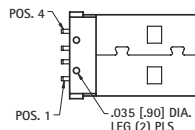
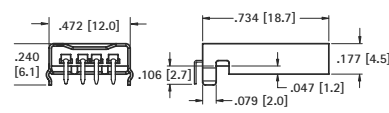

CAT. NO. 932

CABLE PLUG



• Supplied unassembled

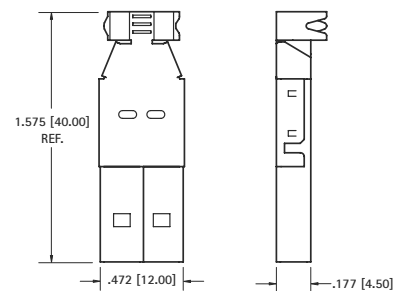

CAT. NO. 925

USB 2.0 PLUGS & SOCKETS

SOCKET SPECIFICATIONS:

Shell: Phosphor Bronze
Insulator: Thermoplastic, UL Rated 94V-0
Contacts: Phosphor Bronze
Contact Area: Gold Flash over Nickel
Solder Trails: Tin over Nickel

PLUG SPECIFICATIONS:

Shell: Steel, Nickel Plate
Insulator: Thermoplastic, Rated UL 94V-0
Contact: Bronze, Gold Flash over Nickel

ELECTRICAL CHARACTERISTICS

Rated Voltage: 30V (RMS)
Contact Current Rating: 1 Amp DC max.
Contact Resistance: 15 mΩ max.
Insulation Resistance: 1000 MΩ min.
Dielectric Withstanding Voltage: 750V AC for 1 minute

MECHANICAL CHARACTERISTICS

Operating Temperature: -13°F (-25°C) to +176°F (+80°C)
Durability: 1500 Cycles min.
DEVICE APPLICATIONS

Ability to daisy chain more than one input device

- Memory Sticks
- Mouse/Keyboards
- Printers/Scanners/Docking Stations
- MP3/Audio Devices
- Digital Video Cameras & Still Cameras
- Portable Media Players
- Gaming Headsets
- Smart Phones/PDA's

MICRO-USB TYPE B SOCKETS/PLUGS

SURFACE MOUNT SOCKET

- Ideal for Miniature applications

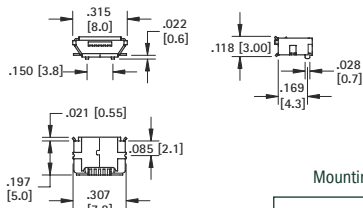

Mounting Detail

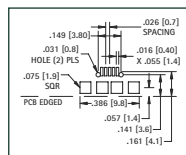

CAT. NO. 940 (Bulk)

CAT. NO. 940TR (Tape & Reel)

Tape & Reel Spec's: 24mm wide; 16mm pitch;
 13 inch reel (1000 pieces per reel)



- Supplied unassembled

CAT. NO. 941

CABLE PLUG

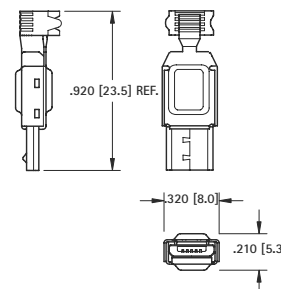

MINI-USB TYPE B SOCKETS/PLUGS

SURFACE MOUNT SOCKET

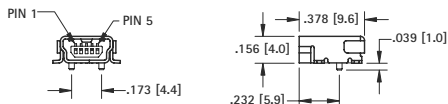

Mounting Detail

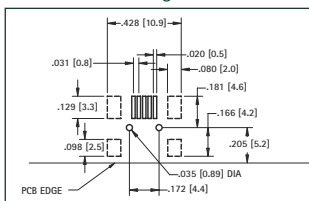

CAT. NO. 934 (Bulk)

CAT. NO. 934TR (Tape & Reel)

Tape & Reel Spec's: 24mm wide; 16mm pitch;
 13 inch reel (1000 pieces per reel)



- Supplied unassembled

CAT. NO. 935

CABLE PLUG

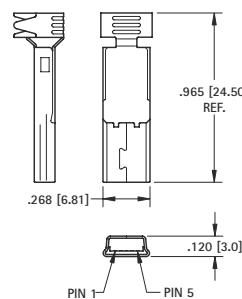

Wiring Detail

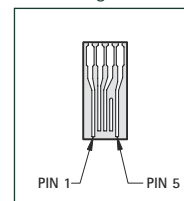

USB TYPE B SOCKETS/PLUGS

THRU HOLE SOCKET

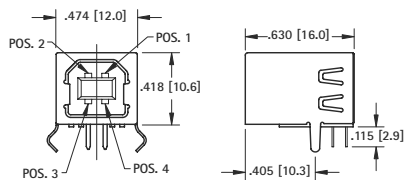

Mounting Detail

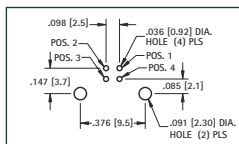

CAT. NO. 924

SURFACE MOUNT SOCKET

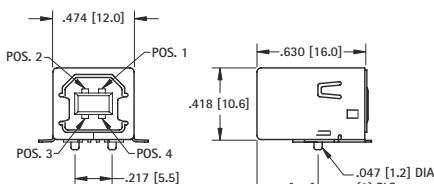

Mounting Detail

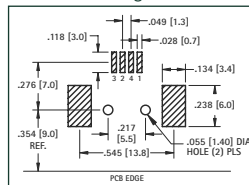

CAT. NO. 933

CABLE PLUG



- Supplied unassembled

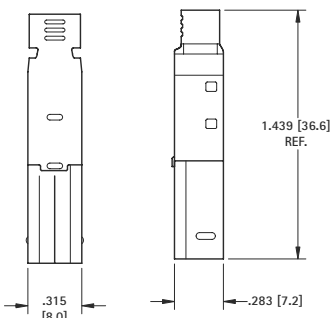

CAT. NO. 926

USB 3.0 PLUGS & SOCKETS

ELECTRICAL CHARACTERISTICS:

Rated Voltage: 30V (RMS)
Contact Current Rating: 1 Amp DC max.
Contact Resistance: 15 mΩ max.
Insulation Resistance: 1000 MΩ min.
Dielectric Withstanding Voltage: 750V AC for 1 minute

MECHANICAL CHARACTERISTICS:

Operating Temperature: -13°F (-25°C) to +176°F(+80°C)
Durability: 1500 Cycles min.

USB 3.0 DESIGN ADVANTAGES:

Port Expansion: Alleviates restriction of limited COM Ports and available IRQ's
Compatibility: Backward compatible with USB 2.0 devices
Fast Data Transfer: Up to 480 Gbps; 10 times faster than USB 2.0 devices and 200 times faster than serial ports.

USB 3.0 (SUPER SPEED) DEVICE APPLICATIONS:

- External hard drives
- High resolution web & video cameras
- Digital video cameras & still cameras
- Multi-channel audio interfaces
- External media such as Blu-Ray drives
- High-definition video content
- Multi-gigabyte mobile phones
- Portable media players

USB TYPE A SOCKETS/PLUGS



THRU-HOLE MOUNT SOCKET

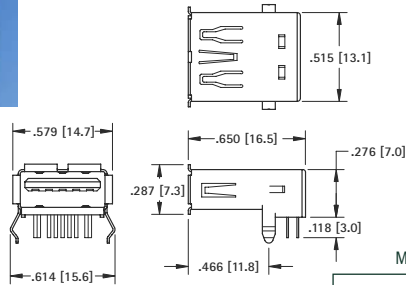

Mounting Detail

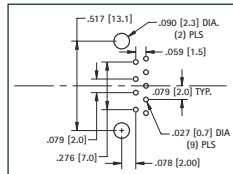

SOCKET SPECIFICATIONS:

Shell: Steel, Nickel Plated
Insulator: Thermoplastic, UL Rated 94V-0
Contacts: Phosphor Bronze, Gold Flash over Nickel

CAT. NO. 945

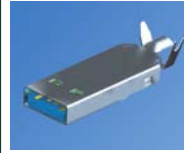

CABLE PLUG

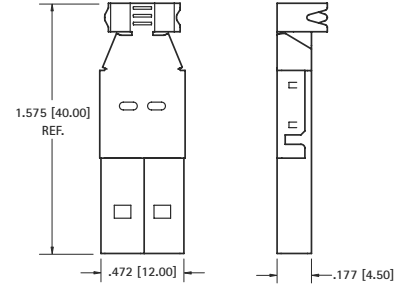

• Supplied unassembled

PLUG SPECIFICATIONS:

Shell: Steel, Nickel Plated
Insulator: Thermoplastic, UL Rated 94V-0
Contacts: Phosphor Bronze, Gold Flash over Nickel

CAT. NO. 947

MICRO-USB TYPE B SOCKETS/PLUGS



SURFACE MOUNT SOCKET

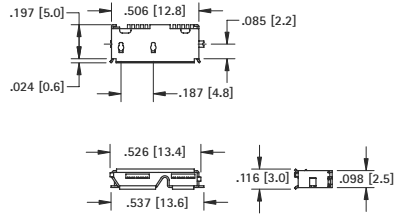

Mounting Detail

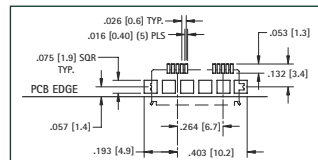

SOCKET SPECIFICATIONS:

Shell: Steel, Nickel Plated
Insulator: Thermoplastic, UL Rated 94V-0
Contacts: Phosphor Bronze, Gold Flash over Nickel

CAT. NO. 955



CABLE PLUG

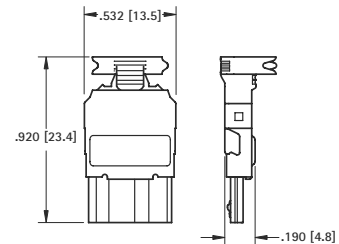

• Supplied unassembled

PLUG SPECIFICATIONS:

Shell: Steel, Nickel Plated
Insulator: Thermoplastic, UL Rated 94V-0
Contacts: Phosphor Bronze, Gold Flash over Nickel

CAT. NO. 957

USB TYPE B SOCKETS/PLUGS



THRU-HOLE MOUNT SOCKET

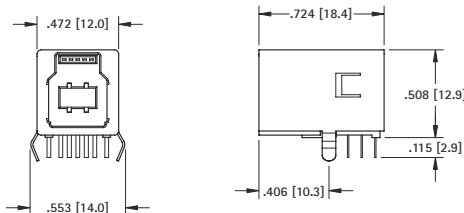

Mounting Detail

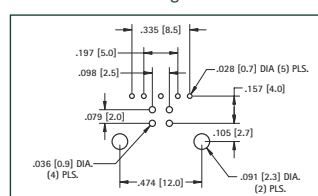

SOCKET SPECIFICATIONS:

Shell: Phosphor Bronze, Nickel Plated
Insulator: Thermoplastic, UL Rated 94V-0
Contacts: Phosphor Bronze, Gold Flash over Nickel
Contact Area: Gold Flash over Nickel
Solder Tails: Tin over Nickel

CAT. NO. 950



CABLE PLUG

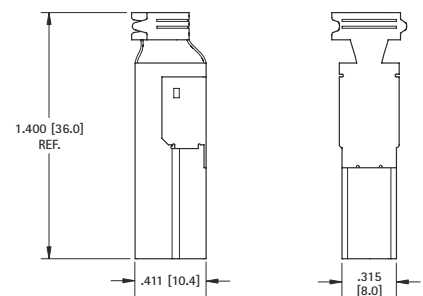

• Supplied unassembled

PLUG SPECIFICATIONS:

Shell: Steel, Nickel Plated
Insulator: Thermoplastic, UL Rated 94V-0
Contacts: Phosphor Bronze, Gold Flash over Nickel

CAT. NO. 952

SUPER SPEED SERIAL BUS - FIREWIRE SOCKETS

FEATURES

- Snap-In PC tails hold connector in position for soldering
- Gold Plated contacts for low contact resistance and excellent reliability

IEEE 1394



SPECIFICATIONS

Shell: Phosphor Bronze
Insulator: Thermoplastic, Rated UL 94V-0
Contacts: Phosphor Bronze
Plating:
Contact Area: Gold Flash over Nickel
Solder Tails: Tin over Nickel Plate

DESIGN ADVANTAGES

Superfast Data Transfer:

Current speeds of 100Mbps, 200Mbps and 400Mbps, and roadmapped to 1GB to 3.2 GBps per second

Daisy Chaining:

Up to 63 devices, each one acts as an active repeater on the bus, with a maximum of 16 repeats

Port Expansion:

Alleviates restriction of limited COM Ports and available IRQ's

Wide Bandwidth:

Operates in asynchronous or isochronous data streams. Digital interface designed for high speed applications for PC peripherals, consumer electronics and communications.

Simple Connections:

True Plug and Play, no jumpers, DIP Switches or IRQ's to set

Hot Swapping:

Allows peripherals to be connected or disconnected without turning off computer

Highly Versatile Bus:

One bus can handle a variety of devices operating at different speed classes for true backwards compatibility

Standard Digital Interface:

Allows consumer electronics and computer devices to communicate together on one interface

ELECTRICAL CHARACTERISTICS

Rated Voltage: 30VAC (RMS)
Contact Current Rating: 1 Amp DC max.
Contact Resistance: 15 mΩ
Insulation Resistance: 1000 mΩ min.
Dielectric Withstanding Voltage: 750V AC for 1 minute
Operating Temperature: 32°F (0°C) to +104°F (40°C)
Capacitance: 2pF max.

MECHANICAL CHARACTERISTICS

Durability: >1500 cycles
Mating Force: 35 Newtons min.
Withdrawal Force: 10 Newtons min.

DEVICE APPLICATIONS

- Broadcast TV
- Cable TV
- Digital Camcorders
- Digital Cameras & VCRs
- Computers & Hard Disks
- DVD Players
- Printers & Monitors
- Stereos

SURFACE MOUNT

HORIZONTAL

SUPPLIED ON TAPE AND REEL

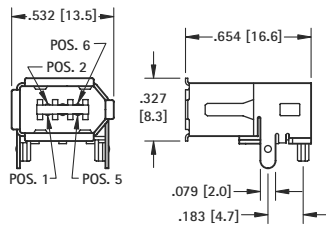

Mounting Detail

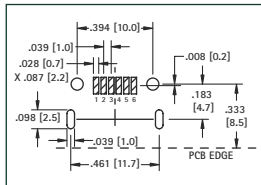

CAT. NO. 927 (Bulk)

CAT. NO. 927TR (Tape & Reel)

Tape & Reel Spec's: 32mm wide; 24mm pitch; 13 inch reel (200 pieces per reel)

THRU HOLE MOUNT

UP-RIGHT

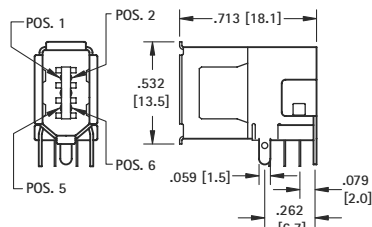

Mounting Detail

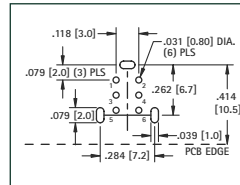

CAT. NO. 930

THRU HOLE MOUNT

HORIZONTAL

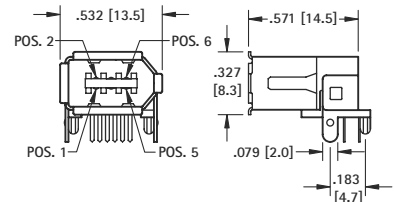

Mounting Detail

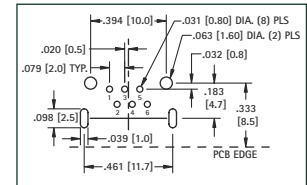

CAT. NO. 929

FIREWIRE PLUG

FEATURES

- Modular design allows easy and fast assembly of components
 - Integrated strain relief - crimps to wire insulation
- Gold Plated contacts for low contact resistance and excellent reliability

IEEE 1394



CAT. NO. 928 (Supplied Unassembled)

SPECIFICATIONS

Shell: Phosphor Bronze
Insulator: Thermoplastic, Rated UL 94V-0
Contacts: Phosphor Bronze
Plating:
Contact Area: Gold Flash over Nickel
Solder Tails: Tin over Nickel Plate

ELECTRICAL CHARACTERISTICS

Contact Resistance: 30mΩ max.
Insulation Resistance: 1000 mΩ min.
Withstanding Voltage: 500V ± 50V DC
Operating Temperature: 32°F (0°C) to +104°F (40°C)

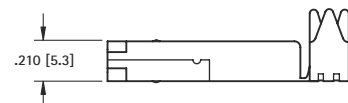
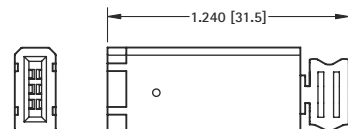

MICRO JACKS



- Space saving design for high density packaging
- Beryllium Copper multi-spring contact maintains retention after multiple insertions
- Ideal for mounting transistors, resistors, diodes, IC's and similar miniature components
- Custom micro jacks manufactured to your specifications
- Other platings available upon request

SPECIFICATIONS

Body: Brass, ASTM-B16
Spring: Beryllium Copper (QQ-C-533)

Plating:

Gold: .000010 per MIL-G-45204
RoHS (RoHS Compliant)

Tin/Lead: .000200 to .000300 per MIL-T-10727, Type 1
RoHS (Non-RoHS Compliant)

PLATING OPTIONS

PLATING	BODY	CONTACT SPRING	RoHS
Gold/Gold	Gold	Gold	Compliant
Tin/Tin	Tin/Lead	Tin/Lead	Non-Compliant
Tin/Gold	Tin/Lead	Gold	



.015 (.38) - .021 (.53) PIN - SOLDER MOUNT

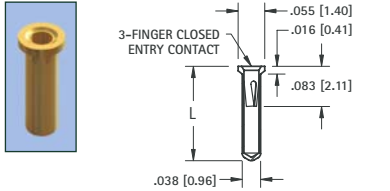

RoHS	NON-RoHS		L Length	Mtg. Hole Dia.
GOLD/GOLD	TIN/TIN	TIN/GOLD		
CAT. NO.	CAT. NO.	CAT. NO.		
1411-1	1431-1	1420-1	.140 (3.6)	.042
1411-2	1431-2	1420-2	.170 (4.3)	(1.07)

.015 (.38) - .021 (.53) PIN - PRESS FIT

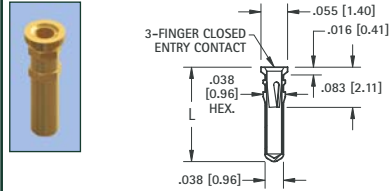

RoHS	NON-RoHS		L Length	Mtg. Hole Dia.
GOLD/GOLD	TIN/TIN	TIN/GOLD		
CAT. NO.	CAT. NO.	CAT. NO.		
1412-1	1432-1	1468-1	.140 (3.6)	.040 (1.02)
1412-2	1432-2	1468-2	.170 (4.3)	
1412-3	1432-3	1468-3	.282 (7.2)	

.015 (.38) - .025 (.64) PIN - TAPER-FIT

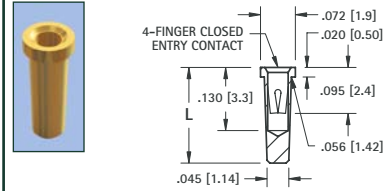

RoHS	NON-RoHS		L Length	Mtg. Hole Dia.
GOLD/GOLD	TIN/TIN	TIN/GOLD		
CAT. NO.	CAT. NO.	CAT. NO.		
1415-1	1435-1	1469-1	.160 (4.1)	.055
1415-2	1435-2	1469-2	.190 (4.8)	(1.40)

.015 (.38) - .025 (.64) PIN - SOLDER MOUNT

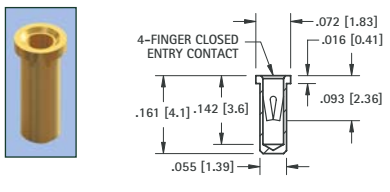

RoHS	NON-RoHS		Mtg. Hole Dia.
GOLD/GOLD	TIN/TIN	TIN/GOLD	
CAT. NO.	CAT. NO.	CAT. NO.	
1413	1433	1470	.059 (1.50)

.015 (.38) - .025 (.64) PIN - SOLDER MOUNT

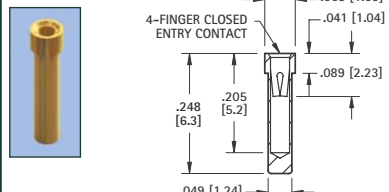

RoHS	NON-RoHS		Mtg. Hole Dia.
GOLD/GOLD	TIN/TIN	TIN/GOLD	
CAT. NO.	CAT. NO.	CAT. NO.	
1603	1606	1607	.052 (1.32)

.022 (.56) - .032 (.81) PIN - SOLDER MOUNT

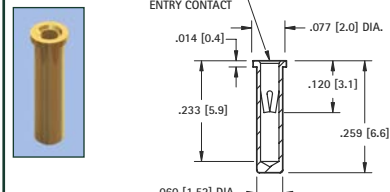

RoHS	NON-RoHS		Mtg. Hole Dia.
GOLD/GOLD	TIN/TIN	TIN/GOLD	
CAT. NO.	CAT. NO.	CAT. NO.	
1693	1694	1695	.063 (1.60)

.022 (.56) - .034 (.86) PIN - PRESS FIT

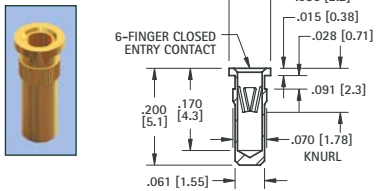

RoHS	NON-RoHS		Mtg. Hole Dia.
GOLD/GOLD	TIN/TIN	TIN/GOLD	
CAT. NO.	CAT. NO.	CAT. NO.	
1416	1436	1471	.067 (1.70)

.022 (.56) - .034 (.86) PIN - SOLDER MOUNT

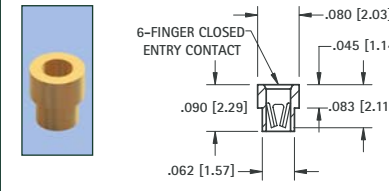

RoHS	NON-RoHS		Mtg. Hole Dia.
GOLD/GOLD	TIN/TIN	TIN/GOLD	
CAT. NO.	CAT. NO.	CAT. NO.	
1658	1659	1673	.065 (1.65)

.025 (.64) - .037 (.94) PIN - SOLDER MOUNT

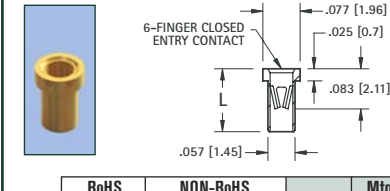

RoHS	NON-RoHS		L Length	Mtg. Hole Dia.
GOLD/GOLD	TIN/TIN	TIN/GOLD		
CAT. NO.	CAT. NO.	CAT. NO.		
1626-1	1614-1	1619-1	.095 (2.4)	.062
1626-2	1614-2	1619-2	.105 (2.7)	(1.57)
1626-3	1614-3	1619-3	.155 (3.9)	

.025 (.64) - .037 (.94) PIN - SOLDER MOUNT

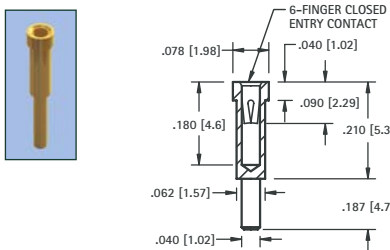

RoHS	NON-RoHS		Mtg. Hole Dia.
GOLD/GOLD	TIN/TIN	TIN/GOLD	
CAT. NO.	CAT. NO.	CAT. NO.	
3590	3591	3592	.065 (1.65)

.025 (.64) - .037 (.94) PIN - PRESS FIT

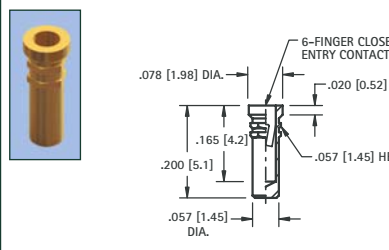

RoHS	NON-RoHS		Mtg. Hole Dia.
GOLD/GOLD	TIN/TIN	TIN/GOLD	
CAT. NO.	CAT. NO.	CAT. NO.	
1697	1698	1699	.063 (1.60)

.032 (.81) - .046 (1.17) PIN - SWAGE MOUNT

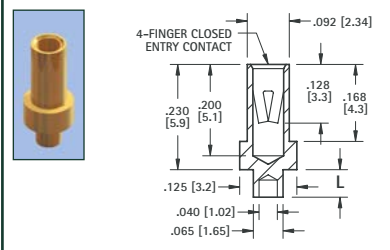

RoHS	NON-RoHS		L Length	Mtg. Hole Dia.
GOLD/GOLD	TIN/TIN	TIN/GOLD		
CAT. NO.	CAT. NO.	CAT. NO.		
1419-1	1439-1	1478-1	.062 (1.6)	.069
1419-2	1439-2	1478-2	.094 (2.4)	(1.75)

MICRO JACKS

MICRO JACKS

.032 (.81) - .046 (1.17) PIN - SOLDER MOUNT

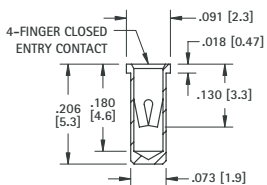

RoHS	NON-RoHS		Mtg. Hole Dia.
GOLD/GOLD	TIN/TIN	TIN/GOLD	
CAT. NO.	CAT. NO.	CAT. NO.	
1417	1437	1479	.076 (1.93)

.032 (.81) - .046 (1.17) PIN - PRESS-FIT

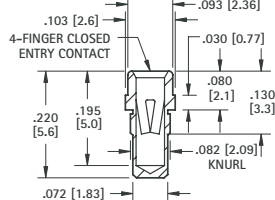

RoHS	NON-RoHS		Mtg. Hole Dia.
GOLD/GOLD	TIN/TIN	TIN/GOLD	
CAT. NO.	CAT. NO.	CAT. NO.	
1443	1446	1473	.078 (1.98)

.032 (.81) - .046 (1.17) PIN - PRESS-FIT

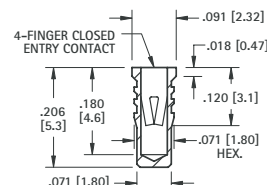

RoHS	NON-RoHS		Mtg. Hole Dia.
GOLD/GOLD	TIN/TIN	TIN/GOLD	
CAT. NO.	CAT. NO.	CAT. NO.	
1442	1445	1486	.076 (1.93)

.032 (.81) - .046 (1.17) PIN - SOLDER MOUNT

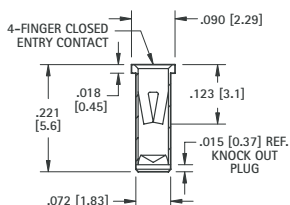

RoHS	NON-RoHS		Mtg. Hole Dia.
GOLD/GOLD	TIN/TIN	TIN/GOLD	
CAT. NO.	CAT. NO.	CAT. NO.	
1441	1444	1488	.076 (1.93)

.032 (.81) - .046 (1.17) PIN - SOLDER MOUNT

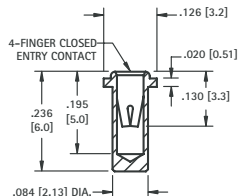

RoHS	NON-RoHS		Mtg. Hole Dia.
GOLD/GOLD	TIN/TIN	TIN/GOLD	
CAT. NO.	CAT. NO.	CAT. NO.	
1674	1675	1676	.087 (2.21)

.032 (.81) - .046 (1.17) PIN - SOLDER MOUNT

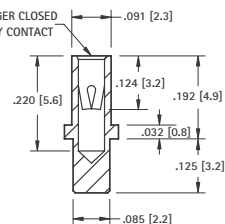

RoHS	NON-RoHS		Mtg. Hole Dia.
GOLD/GOLD	TIN/TIN	TIN/GOLD	
CAT. NO.	CAT. NO.	CAT. NO.	
1677	1678	1679	.089 (2.26)

.032 (.81) - .046 (1.17) PIN - SOLDER MOUNT

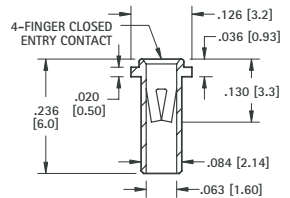

RoHS	NON-RoHS		Mtg. Hole Dia.
GOLD/GOLD	TIN/TIN	TIN/GOLD	
CAT. NO.	CAT. NO.	CAT. NO.	
1414	1434	1496	.089 (2.26)

.040 (1.02) - .050 (1.27) PIN - SOLDER MOUNT

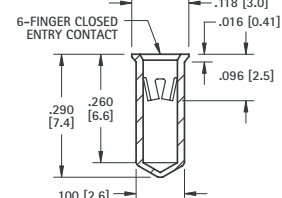

RoHS	NON-RoHS		Mtg. Hole Dia.
GOLD/GOLD	TIN/TIN	TIN/GOLD	
CAT. NO.	CAT. NO.	CAT. NO.	
1418	1438	1497	.104 (2.6)

.048 (1.22) - .064 (1.63) PIN - SOLDER MOUNT

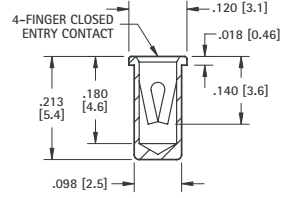

RoHS	NON-RoHS		Mtg. Hole Dia.
GOLD/GOLD	TIN/TIN	TIN/GOLD	
CAT. NO.	CAT. NO.	CAT. NO.	
1682	1683	1684	.102 (2.6)

.065 (1.65) - .082 (2.08) PIN - SOLDER MOUNT

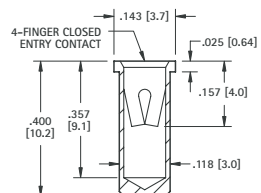

RoHS	NON-RoHS		Mtg. Hole Dia.
GOLD/GOLD	TIN/TIN	TIN/GOLD	
CAT. NO.	CAT. NO.	CAT. NO.	
1641A	1641B	1641C	.122 (3.1)

.065 (1.65) - .082 (2.08) PIN - SOLDER MOUNT

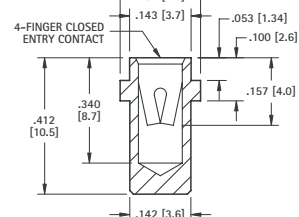

RoHS	NON-RoHS		Mtg. Hole Dia.
GOLD/GOLD	TIN/TIN	TIN/GOLD	
CAT. NO.	CAT. NO.	CAT. NO.	
1687	1688	1689	.146 (3.7)

.084 (2.13) - .102 (2.6) PIN - PRESS-FIT

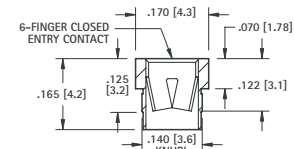

RoHS	NON-RoHS		Mtg. Hole Dia.
GOLD/GOLD	TIN/TIN	TIN/GOLD	
CAT. NO.	CAT. NO.	CAT. NO.	
1640A	1640B	1640C	.138 (3.5)

.032 (.81) - .046 (1.17) PIN - CRIMP BARREL JACK

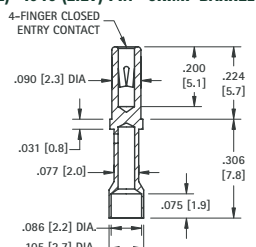

RoHS	NON-RoHS		
GOLD/GOLD	TIN/TIN	TIN/GOLD	
CAT. NO.	CAT. NO.	CAT. NO.	
3593	3594	3595	

IC SOCKET CONTACTS FOR .015 (.38) - .025 (.64) LEADS - PRESS-FIT

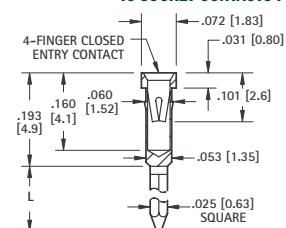

RoHS	NON-RoHS		L Length	Mtg. Hole Dia.
GOLD/GOLD	TIN/TIN	TIN/GOLD		
CAT. NO.	CAT. NO.	CAT. NO.		
3501	3505	3504	.360 (9.2)	.057
3502	3506	3508	.510 (13.0)	(1.45)

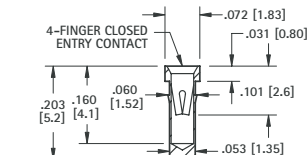

RoHS	NON-RoHS		Mtg. Hole Dia.
GOLD/GOLD	TIN/TIN	TIN/GOLD	
CAT. NO.	CAT. NO.	CAT. NO.	
3503	3507	3509	.057 (1.45)

MICRO PINS



- Precision engineered and manufactured
- Space saving design for high density packaging
- Micro pins are available in .017 (.43) to .080 (2.03) diameters
- Ideal for mating with our standard line of micro jacks
- Available for press-fit, swage or solder mounting
- Custom micro pins manufactured to your specifications
- Other platings available upon request

SPECIFICATIONS

Material: Brass, ASTM-B16

Plating:

Gold: .000010 per MIL-G-45204

Tin: .000200 to .000300 per

MIL-T-10727, Type 1

RoHS (RoHS Compliant)

DASH NUMBERS (L Dimension)

- 1 for .032 (.81) thick Board
- 2 for .062 (1.57) thick Board
- 3 for .093 (2.36) thick Board
- 4 for .125 (3.2) thick Board

Example: 1967-1 for .032 (.81) thick Board
1967-2 for .062 (1.57) thick Board

.017 (.43) PIN - SWAGE MOUNT

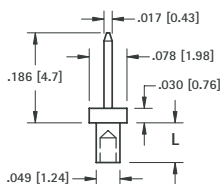

GOLD CAT. NO.	TIN CAT. NO.	L Length	Mtg. Hole Dia.
1967-1	1968-1	.051 (1.3)	.052 (1.32)
1967-2	1968-2	.082 (2.0)	

.017 (.43) PIN - SOLDER MOUNT

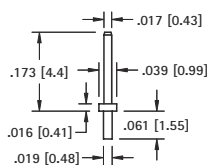

GOLD CAT. NO.	TIN CAT. NO.	Mtg. Hole Dia.
1378-1	1379-1	.022 (.56)

.018 (.46) PIN - PRESS-FIT

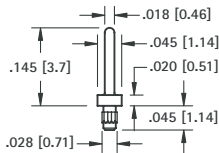

GOLD CAT. NO.	TIN CAT. NO.	Mtg. Hole Dia.
1986-1	1987-1	.026 (.66)

.018 (.46) PIN - PRESS-FIT

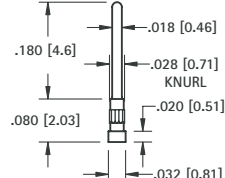

MATERIAL: Phosphor Bronze

GOLD CAT. NO.	TIN CAT. NO.	Mtg. Hole Dia.
1990-2	1991-2	.026 (.66)

.018 (.46) PIN - PRESS-FIT

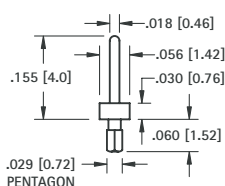

GOLD CAT. NO.	TIN CAT. NO.	Mtg. Hole Dia.
1988-2	1989-2	.026 (.66)

.018 (.46) PIN - PRESS-FIT

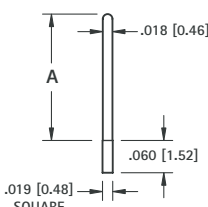

GOLD CAT. NO.	TIN CAT. NO.	A Dim.	Mtg. Hole Dia.
1992-2	1994-2	.243 (6.2)	.022 (.56)
1993-2	1995-2	.140 (3.6)	

.020 (.51) PIN - PRESS-FIT

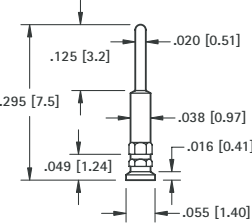

GOLD CAT. NO.	TIN CAT. NO.	Mtg. Hole Dia.
1996-2	1997-2	.040 (1.01)

.020 (.51) PIN - SOLDER MOUNT

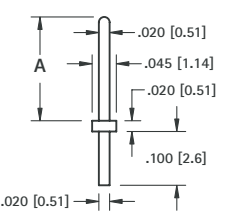

GOLD CAT. NO.	TIN CAT. NO.	A Dim.	Mtg. Hole Dia.
1998-3	2000-3	250 (6.4)	.024 (.61)
1999-3	2001-3	425 (10.8)	

.020 (.51) PIN - SWAGE MOUNT

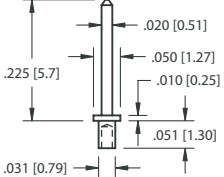

GOLD CAT. NO.	TIN CAT. NO.	Mtg. Hole Dia.
1366-1	1367-1	.035 (.89)

.020 (.51) PIN - SWAGE MOUNT

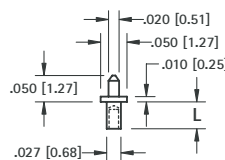

GOLD CAT. NO.	TIN CAT. NO.	L Length	Mtg. Hole Dia.
1372-1	1373-1	.051 (1.3)	.031 (.78)
1372-2	1373-2	.082 (2.1)	

.024 (.61) PIN - SWAGE MOUNT

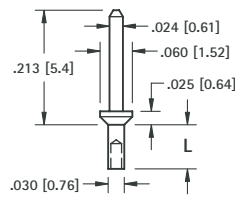

GOLD CAT. NO.	TIN CAT. NO.	L Length	Mtg. Hole Dia.
1406-1	1426-1	.047 (1.2)	.035 (.89)
1406-2	1426-2	.078 (1.9)	

.025 (.64) PIN - SWAGE MOUNT

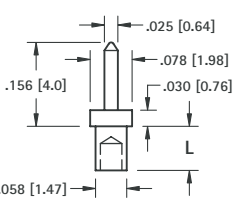
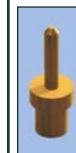

GOLD CAT. NO.	TIN CAT. NO.	L Length	Mtg. Hole Dia.
1408-1	1428-1	.062 (1.6)	.062 (1.57)
1408-2	1428-2	.094 (2.4)	

.025 (.64) PIN - SWAGE MOUNT

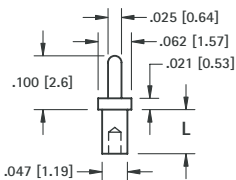

GOLD CAT. NO.	TIN CAT. NO.	L Length	Mtg. Hole Dia.
1404-1	1424-1	.051 (1.3)	.052 (1.32)
1404-2	1424-2	.082 (2.1)	

.025 (.64) PIN - SWAGE MOUNT

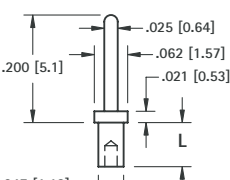

GOLD CAT. NO.	TIN CAT. NO.	L Length	Mtg. Hole Dia.
1407-1	1427-1	.051 (1.3)	.052 (1.32)
1407-2	1427-2	.082 (2.1)	

.025 (.64) PIN - SWAGE MOUNT

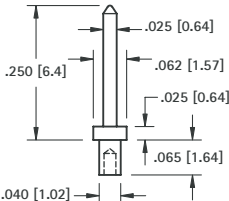

GOLD CAT. NO.	TIN CAT. NO.	Mtg. Hole Dia.
1401-1	1421-1	.043 (1.09)

.025 (.64) PIN - SWAGE MOUNT

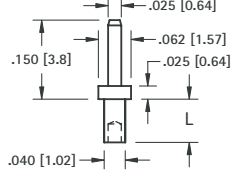

GOLD CAT. NO.	TIN CAT. NO.	L Length	Mtg. Hole Dia.
1368-1	1369-1	.051 (1.3)	.043 (1.09)
1368-2	1369-2	.082 (2.1)	
1368-3	1369-3	.113 (2.9)	

MICRO PINS

.025 (.64) PIN - SWAGE MOUNT

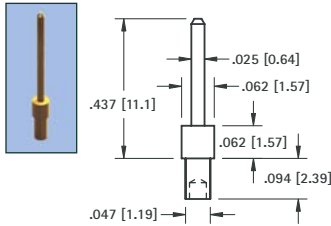

GOLD CAT. NO.	TIN CAT. NO.	Mtg. Hole Dia.
1370-2	1371-2	.052 (1.32)

.030 (.76) PIN - SWAGE MOUNT

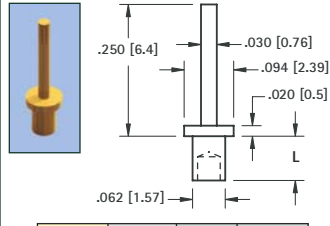

GOLD CAT. NO.	TIN CAT. NO.	L Length	Mtg. Hole Dia.
1374-1	1375-1	.051 (1.3)	.067 (1.70)
1374-2	1375-2	.082 (2.1)	
1374-3	1375-3	.113 (2.9)	

.031 (.79) PIN - SOLDER MOUNT

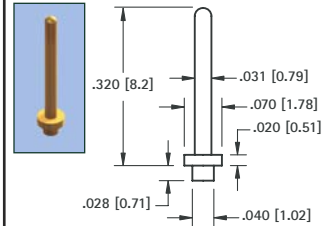

GOLD CAT. NO.	TIN CAT. NO.	Mtg. Hole Dia.
1352-1	1353-1	.043 (1.09)

.032 (.81) PIN - SWAGE MOUNT

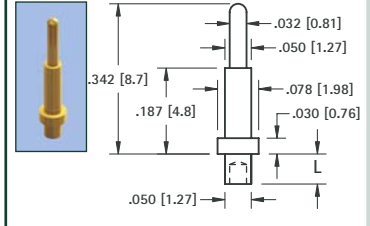

GOLD CAT. NO.	TIN CAT. NO.	L Length	Mtg. Hole Dia.
1354-1	1355-1	.051 (1.3)	.052 (1.32)
1354-2	1355-2	.082 (2.1)	

.035 (.90) PIN - SWAGE MOUNT

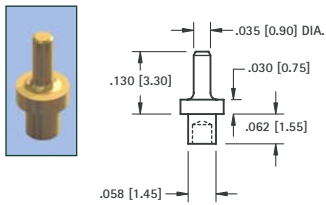

GOLD CAT. NO.	TIN CAT. NO.	Mtg. Hole Dia.
1380-1	1381-1	.062 (1.57)

.040 (1.0) PIN - SWAGE MOUNT

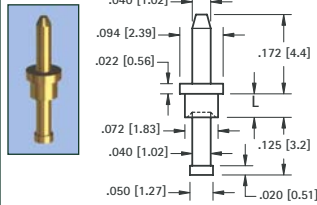

GOLD CAT. NO.	TIN CAT. NO.	L Length	Mtg. Hole Dia.
1356-1	1357-1	.051 (1.3)	.076 (1.93)
1356-2	1357-2	.082 (2.1)	
1356-3	1357-3	.113 (2.9)	

.040 (1.0) PIN - SWAGE MOUNT

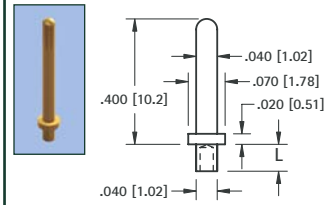

GOLD CAT. NO.	TIN CAT. NO.	L Length	Mtg. Hole Dia.
1358-1	1359-1	.051 (1.3)	.043 (1.09)
1358-2	1359-2	.082 (2.1)	

.040 (1.0) PIN - SWAGE MOUNT

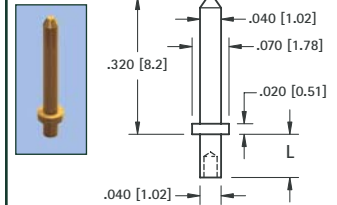

GOLD CAT. NO.	TIN CAT. NO.	L Length	Mtg. Hole Dia.
1405-1	1425-1	.051 (1.3)	.043 (1.09)
1405-2	1425-2	.082 (2.1)	
1405-3	1425-3	.113 (2.9)	

.040 (1.0) PIN - SWAGE MOUNT

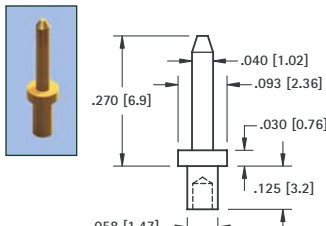

GOLD CAT. NO.	TIN CAT. NO.	Mtg. Hole Dia.
1402-3	1422-3	.062 (1.57)

.040 (1.0) KAY PIN - PRESS-FIT

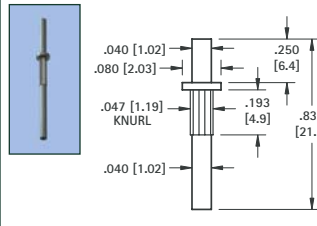

MATERIAL:
Solid Nickel Silver
CAT. NO. 1218
Mtg. Hole .043 (1.09) Dia.

.040 (1.0) HOLLOW PIN - SWAGE MOUNT

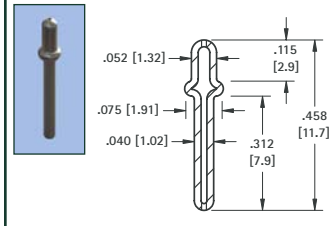

TIN CAT. NO.	Mtg. Hole Dia.
1219	.059 (1.50)

.050 (1.3) PIN - SWAGE MOUNT

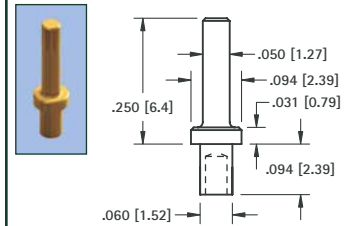

GOLD CAT. NO.	TIN CAT. NO.	Mtg. Hole Dia.
1360-2	1361-2	.064 (1.63)

.063 (1.6) PIN - SWAGE MOUNT

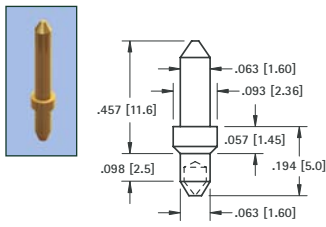

GOLD CAT. NO.	TIN CAT. NO.	Mtg. Hole Dia.
1362-2	1363-2	.067 (1.70)

.080 (2.0) PIN - SWAGE MOUNT

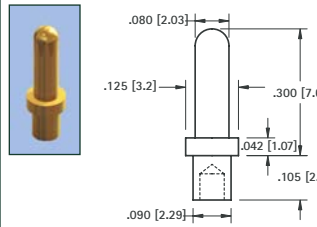

GOLD CAT. NO.	TIN CAT. NO.	Mtg. Hole Dia.
1376-2	1377-2	.094 (2.38)

.080 (2.0) PIN - SWAGE MOUNT

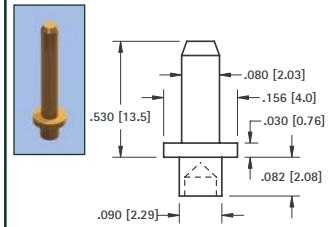

GOLD CAT. NO.	TIN CAT. NO.	Mtg. Hole Dia.
1364-2	1365-2	.094 (2.38)

.080 (2.0) PIN - SWAGE MOUNT

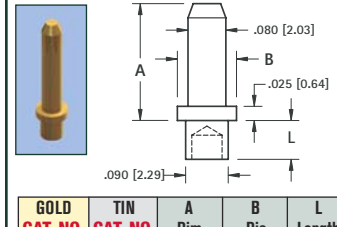

GOLD CAT. NO.	TIN CAT. NO.	A Dim.	B Dia.	L Length
1447-1	1455-1	.335 (8.5)	.156 (4.0)	.051 (1.3)
1447-2	1455-2	.400 (10.2)	.125 (3.2)	.094 (2.4)
1447-3	1455-3	.400 (10.2)	.125 (3.2)	.125 (3.2)
1447-4	1455-4	.400 (10.2)	.125 (3.2)	.156 (4.0)

INSULATED SHORTING PLUG

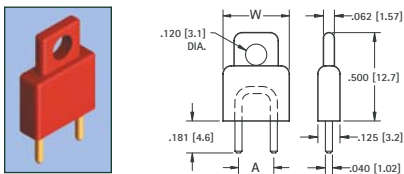

BLUE CAT. NO.	RED CAT. NO.	BLACK CAT. NO.	A Dim.	W Dim.
1460L	1460R	1460B	.200 (5.1)	.375 (9.5)
1461L	1461R	1461B	.250 (6.4)	.375 (9.5)
1462L	1462R	1462B	.400 (10.2)	.620 (15.7)
1463L	1463R	1463B	.500 (12.7)	.620 (15.7)

MATERIAL:
Insulator: Polypropylene
Blue, Red or Black
Pin: Brass, Gold Plate

.040 (1.0) PINS



Non-insulated CAT. NO.	A Dim.
1430-1	.200 (5.1)
1430-2	.250 (6.4)
1430-4	.400 (10.2)
1430-5	.500 (12.7)

SHORTING PIN

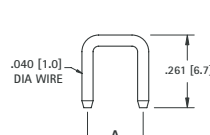

MATERIAL:
Pin: Brass, Gold Plate

INSULATED SHORTING JACK

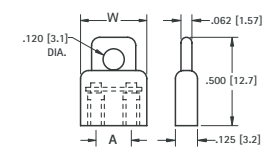
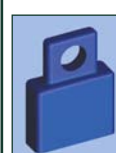

• For .040 (1.0) Pins

BLUE CAT. NO.	RED CAT. NO.	BLACK CAT. NO.	A Dim.	W Dim.
1487L	1487R	1487B	.200 (5.1)	.375 (9.5)
1400L	1400R	1400B	.400 (10.2)	.620 (15.7)

MATERIAL:
Insulator: Polypropylene
Blue, Red or Black
Spring: Beryllium Copper, Gold Plate

PHONO PLUGS

• Mates with .125 (3.2) diameter jacks

STRAIN RELIEF LUG CRIMPS TO WIRE INSULATION

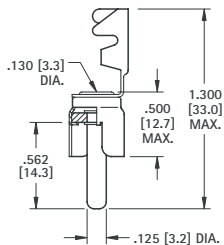

MATERIAL:
Shell: Steel, Tin Plate
Pin: Brass, Nickel Plate

CAT. NO. 565

CONVENTIONAL TYPE

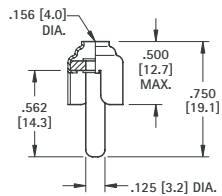

MATERIAL:
Shell: Brass, Nickel Plate
Pin: Brass, Nickel Plate

CAT. NO. 561

CRIMP OR SOLDER TYPE EXTRA LONG HANDLE

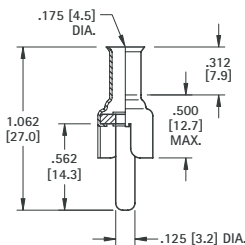

MATERIAL:
Shell: Steel, Tin Plate
Pin: Brass, Nickel Plate

CAT. NO. 567

"F" FEMALE CONNECTOR

SNAP-FIT PC MOUNT

- Low profile
- Snap-fit mounting for positive retention during wave soldering
- Rugged, stable construction facilitates reliable mating
- High reliability, manufactured using Nickel Plated Brass bodies and Tin Plated Phosphor Bronze contacts
- Supplied with washer and nut

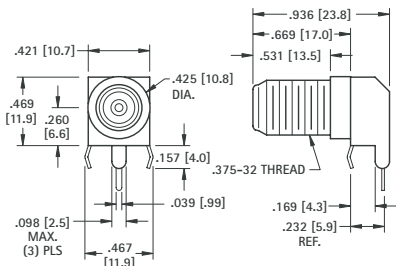

Mounting Detail

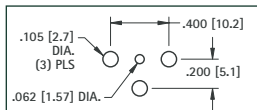

MATERIAL:
Shell: Steel, Tin Plate
Body: Brass, Nickel Plate
Contacts: Brass, Tin Plate

CAT. NO. 911

PANEL MOUNT PHONO JACKS

- Mates with .125 (3.12) dia. pin
- Mounts to panel in .296 (7.6) dia. hole
- Color coded for ease of identification
- Complete with nut and solder lug

ROUND BASE

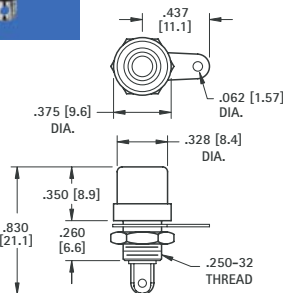

CAT. NO.	INSULATOR COLOR
598	WHITE
580	RED
574	BLACK
599	YELLOW

MATERIAL:
Brass, Nickel Plate

HEX BASE

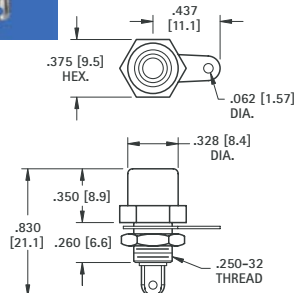

CAT. NO.	INSULATOR COLOR
581	WHITE
582	RED
576	BLACK
583	YELLOW

COLOR KEYED - PC PHONO JACKS

- Mates with .125 (3.2) diameter pins
- Features a normally closed circuit
- Various colors for circuit identification
- Snap-fit mounting for positive retention during wave soldering

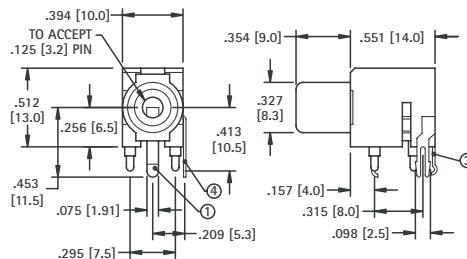
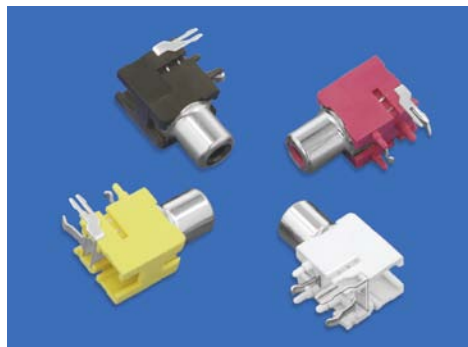

CAT. NO.	INSULATOR COLOR
970	WHITE
971	RED
972	BLACK
973	YELLOW

SPECIFICATIONS

Housing: PBT
Ground Terminal: .020 (.51) Brass, Nickel Plate ①
Spring Contact: .012 (.30) Phosphor Bronze, Silver Plate ③
Shunt Terminal: .016 (.41) thick Brass, Silver Plate ④

SCHEMATIC



Mounting Detail

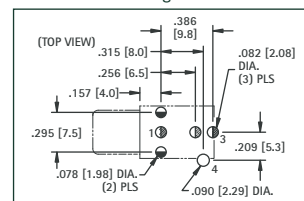

90° PC PHONO JACK



Complete one piece jack for insertion into PC board.
Time Saving. No Wiring Required.

- Black insulator ring.

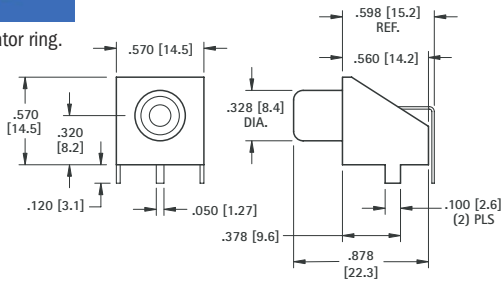

Mounting Detail

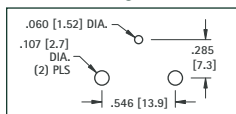

MATERIAL:

Base: Steel, Tin Plate
Shell: Steel, Nickel Plate
Contact: Brass, Tin Plate

CAT. NO. 902

SNAP-FIT 90° PC PHONO JACKS



CHOICE OF TIN OR GOLD PLATE

Complete one piece jack for insertion into PC board.
Time Saving. No Wiring Required.
Snap-fits into PC board.

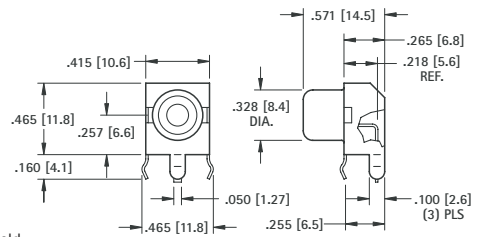

MATERIAL:

Shell: Steel
Contact: Brass
Plating: Tin or Gold

TIN PLATE CAT. NO.	INSULATOR COLOR	GOLD PLATE CAT. NO.
587	WHITE	936
588	RED	937
901	BLACK	900
589	YELLOW	938

Mounting Detail

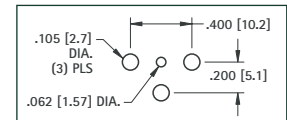

SNAP-FIT VERTICAL PC JACK

- Snaps into holes on PC board and firmly held for soldering
- No staking required



- Red insulator ring

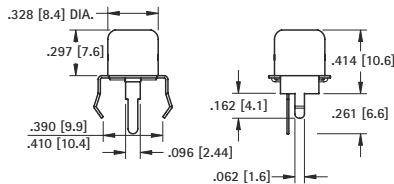

Mounting Detail

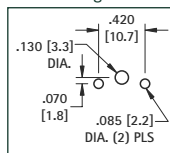

MATERIAL:

Shell: Steel, Tin Plate
Contact: Brass, Tin Plate

CAT. NO. 572

SNAP-FIT VERTICAL PC PHONO JACKS

- Extra long, one piece shell to accept plugs with longer pins for greater contact
- Snaps into holes on PC board and firmly held for soldering
- No staking required

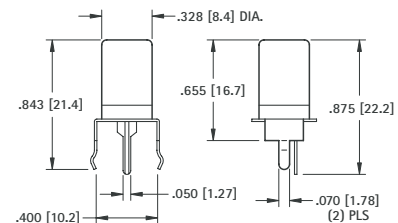

Mounting Detail

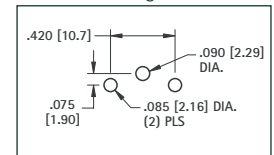

CAT. NO.	INSULATOR COLOR
584	WHITE
577	RED
585	BLACK
586	YELLOW

MATERIAL:

Shell: Steel, Nickel Plate
Contact: Brass, Tin Plate

PC PHONO JACKS

VERTICAL

- For applications requiring staking to product



- White insulator ring

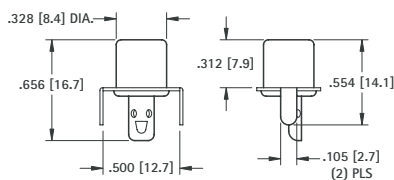

Mounting Detail

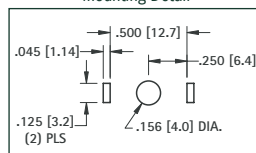

MATERIAL:

Shell: Steel, Tin Plate
Contact: Brass, Tin Plate

CAT. NO. 573

HORIZONTAL

- Mounted on bracket ready for insertion into pre-drilled holes
- Solder lug allows remote attachment of signal to PC board



- Red insulator ring

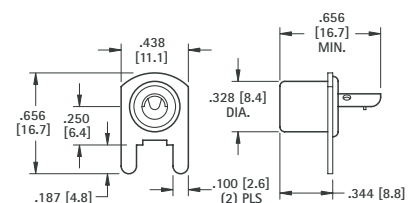

Mounting Detail

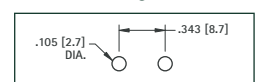

MATERIAL:

Shell: Steel, Tin Plate
Contact: Brass, Tin Plate

CAT. NO. 571

FULLY INSULATED DELUXE TIP JACK

ACCEPTS .080 (2.0) TIP WITH CLOSED ENTRY CONTACT

Fully molded body with recessed closed entry design. Assures maximum retention with .010Ω maximum contact resistance. Prevents accidental insertion of larger diameter probes. Current rating: 10 Amps. Breakdown voltage 5700V RMS. Capacitance to metal panel 2.0 pF nominal. Supplied with nut.

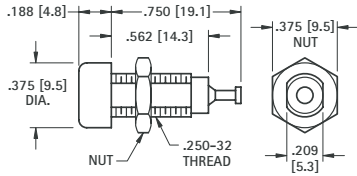

CAT. NO.	COLOR
6030	WHITE
6031	RED
6032	BLACK
6033	GREEN
6034	YELLOW
6035	BLUE

MATERIAL:

Body: Molded Nylon ASTM D4066
Contact: Beryllium Copper, Silver Plate
Terminal: Brass, Tin Plate

FULLY INSULATED STANDARD TIP JACK

ACCEPTS .080 (2.0) TIP

Economical tip jacks with molded Nylon body. Low contact resistance. Formed Phosphor Bronze contact with solder hole for ease in attaching wire. Current rating 10 Amps. Breakdown voltage 5700 VRMS. Capacitance to metal panel 3.8 pF. Supplied with nut.

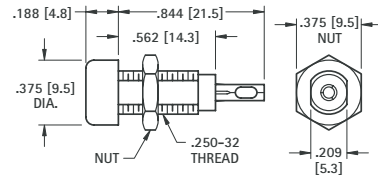

CAT. NO.	COLOR
6018	WHITE
6019	RED
6020	BLACK
6021	GREEN
6022	YELLOW
6023	BLUE

MATERIAL:

Body: Molded Nylon ASTM D4066
Contact: Phosphor Bronze, Tin Plate

METAL-CLAD TIP JACK (MIL)

ACCEPTS .080 (2.0) TIP WITH CLOSED ENTRY CONTACT

High quality tip jack for high reliability industrial applications. Ideal for use where required to withstand severe environmental conditions, temperature, vibration and salt spray. Recessed closed entry contact. Current rating 10 amps. Breakdown voltage: 5700V RMS. Made to MIL-C39024/10. Capacitance to metal panel 2.0 pF. Supplied complete with hardware.

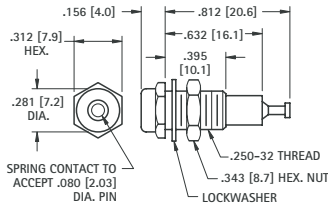

MATERIAL:

Body: Molded Nylon ASTM D4066
Shell & Nut: Brass QQ-B-626, Nickel Plate QQ-N-290
Contact: Beryllium Copper for QQ-C-533. Gold Plate MIL-G-45204

CAT. NO.	COLOR
6012	WHITE
6013	RED
6014	BLACK
6015	GREEN
6016	YELLOW
6017	BLUE

METAL-CLAD TIP JACK (STD)

ACCEPTS .080 (2.0) TIP

Molded Nylon body with metal jacket. Contact is formed from phosphor bronze contact with solder hole for ease in attaching wire. Designed for positive contact, easy insertion and withdrawal. Current rating: 10 Amps. Breakdown voltage 5700V RMS. Capacitance to metal panel 3.8 pF. Supplied with nut.

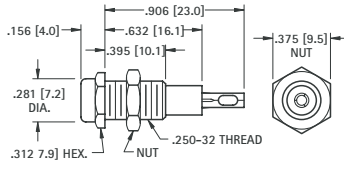

MATERIAL:

Body: Molded Nylon ASTM D4066
Shell: Brass, Nickel Plate
Contact: Phosphor Bronze, Silver Plate

CAT. NO.	COLOR
6024	WHITE
6025	RED
6026	BLACK
6027	GREEN
6028	YELLOW
6029	BLUE

UNINSULATED TIP JACK

ACCEPTS .080 (2.0) TIP

Quality, precision machined tip jack made of brass. Ideal for use on metal panels where grounding is required. Fits panels up to .375 (9.5) Thick. Supplied with nut.

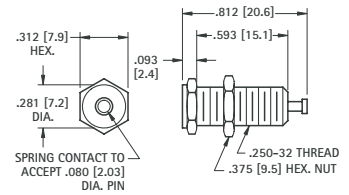

MATERIAL:

Body: Brass, Nickel Plate
Contact: Beryllium Copper
Current Rating: 15 Amps

CAT. NO. 6097

SOLDER TIP PLUGS

.080 (2.0) DIAMETER TIP



Designed for miniaturization where space is critical. Solder lead connection. Maximum reliability with minimum contact resistance. Base of tip is recessed to eliminate shock or grounding. Fits all standard jacks.

MATERIAL:

Tip: Brass, Nickel Plate
Handle: Nylon 6/6
Current Rating: 10 Amps.

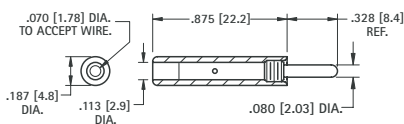

CAT. NO.	COLOR	CAT. NO.	COLOR
6006	WHITE	6009	GREEN
6007	RED	6010	YELLOW
6008	BLACK	6011	BLUE

SOLDERLESS TIP PLUGS

.080 (2.0) DIAMETER TIP



Fully insulated molded nylon sleeve. Maximum reliability with minimum contact resistance. Recessed metal head eliminates possibility of shock or grounding. Designed for solderless connection of up to 16 gauge stranded wire which fits through handle and tip and is secured by screwing handle tight. Fits all standard tip jacks.

MATERIAL:

Tip: Brass, Nickel Plate
Handle: Nylon 6/6
Current Rating: 10 Amps.

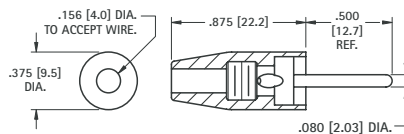

CAT. NO.	COLOR	CAT. NO.	COLOR
6000	WHITE	6003	GREEN
6001	RED	6004	YELLOW
6002	BLACK	6005	BLUE

STANDARD PHONE TIP

.080 (2.0) DIAMETER TIP



Accepts up to 12 gauge wire. Fits all standard tip jacks.

MATERIAL: Brass, Nickel Plate

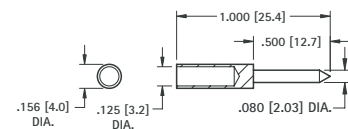

CAT. NO. 1601

.080 [2.0] PC TEST JACKS



VERTICAL

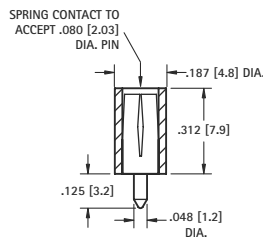

CAT. NO.	COLOR
6036	WHITE
6037	RED
6038	BLACK
6039	YELLOW
6040	GREEN
6041	BLUE

MATERIAL:
Body: Nylon per ASTM D4066
Contact: Brass, Silver Plate

SNAP-FIT VERTICAL

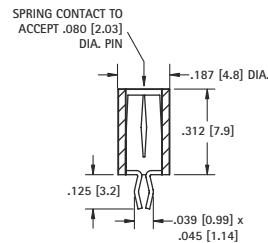

CAT. NO.	COLOR
6042	WHITE
6043	RED
6044	BLACK
6045	YELLOW
6046	GREEN
6047	BLUE

MATERIAL:
Body: Nylon per ASTM D4066
Contact: Beryllium Copper, Silver Plate
Mounting: Snap-fits into .052 (1.32) hole

LOW PROFILE HORIZONTAL

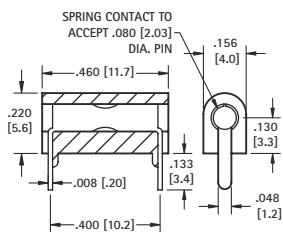

GOLD PLATE CAT. NO.	COLOR	SILVER PLATE CAT. NO.
6060	WHITE	6066
6061	RED	6067
6062	BLACK	6068
6063	YELLOW	6069
6064	GREEN	6070
6065	BLUE	6071

MATERIAL:
Body: Nylon per ASTM D4066
Contact: Beryllium Copper, Gold or Silver Plate

UNIVERSAL HORIZONTAL

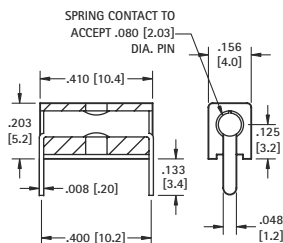

CAT. NO.	COLOR
6054	WHITE
6055	RED
6056	BLACK
6057	YELLOW
6058	GREEN
6059	BLUE

MATERIAL:
Body: Nylon per ASTM D4066
Contact: Beryllium Copper, Silver Plate

MINIATURE HORIZONTAL

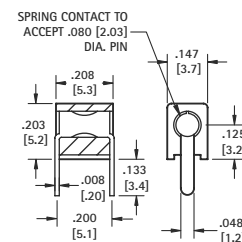

CAT. NO.	COLOR
6048	WHITE
6049	RED
6050	BLACK
6051	YELLOW
6052	GREEN
6053	BLUE

MATERIAL:
Body: Nylon per ASTM D4066
Contact: Beryllium Copper, Silver Plate

HIGH TEMPERATURE PTFE INSULATED TEST POINT JACKS

SPECIFICATIONS

Terminal Jack: Beryllium Copper (QQ-C-533)
 *Brass ASTM B16
Plating: Gold per MIL-G-45204, Type II
Operating Temperature: -60 (-50) to + 500

Bushing:

White PTFE **RoHS** (RoHS Compliant)
 Red or Black PTFE **RoHS** (Non-RoHS Compliant)

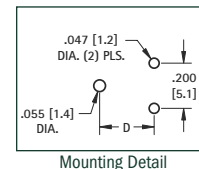

FIG. 1

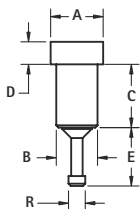

FIG. 2

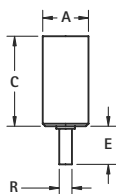
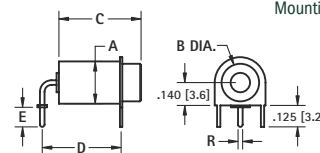

FIG. 3



RoHS			NON-RoHS			Accepts						
White	Red	Black	FIG.	A	B	C	D	E	R	Tip Dia. ± .001 (.03)	Tip Length	
11001	11001-R	11001-B	1	.142 (3.6)	.120 (3.0)	.244 (6.2)	.046 (1.2)	.120 (3.0)	.060 (1.5)	.040 (1.0)	.205 (5.2)	
11002	11002-R	11002-B	1	.142 (3.6)	.120 (3.0)	.283 (7.2)	.046 (1.2)	.120 (3.0)	.060 (1.5)	.040 (1.0)	.245 (6.2)	
11003	11003-R	11003-B	1	.172 (4.4)	.140 (3.6)	.142 (3.6)	.050 (1.3)	.060 (1.5)	.080 (2.0)	.040 (1.0)	.125 (3.2)	
11004	11004-R	11004-B	1	.172 (4.4)	.148 (3.8)	.179 (4.5)	.046 (1.2)	.120 (3.0)	.060 (1.5)	.040 (1.0)	.140 (3.6)	
11005	11005-R	11005-B	1	.218 (5.5)	.185 (4.7)	.301 (7.6)	.050 (1.3)	.105 (2.7)	.125 (3.2)	.080 (2.0)	.315 (8.0)	
11006	11006-R	11006-B	1	.218 (5.5)	.185 (4.7)	.271 (6.9)	.046 (1.2)	.120 (3.0)	.074 (1.9)	.080 (2.0)	.195 (4.9)	
11007	11007-R	11007-B	1	.218 (5.5)	.185 (4.7)	.271 (6.9)	.046 (1.2)	.120 (3.0)	.074 (1.9)	.090 (2.3)	.195 (4.9)	
11008	11008-R	11008-B	1	.218 (5.5)	.185 (4.7)	.301 (7.6)	.046 (1.2)	.120 (3.0)	.074 (1.9)	.080 (2.0)	.225 (5.7)	
11009	11009-R	11009-B	1	.218 (5.5)	.185 (4.7)	.400 (10.2)	.050 (1.3)	.187 (4.8)	.074 (1.9)	.080 (2.0)	.280 (7.1)	
11010	11010-R	11010-B	1	.218 (5.5)	.185 (4.7)	.271 (6.9)	.046 (1.2)	.136 (3.5)	.074 (1.9)	.080 (2.0)	.340 (8.6)	
11011	11011-R	11011-B	2	.218 (5.5)	-	.430 (10.9)	-	.150 (3.8)	.050 (1.3)	.080 (2.0)	.200 (5.1)	
11012*	11012-R*	11012-B*	2	.218 (5.5)	-	.500 (12.7)	-	.150 (3.8)	.050 (1.3)	.080 (2.0)	.280 (7.1)	
11013	11013-R	11013-B	3	.218 (5.5)	.187 (4.8)	.689 (17.5)	.500 (12.7)	.125 (3.2)	.050 (1.3)	.080 (2.0)	.500 (12.7)	
11014	11014-R	11014-B	3	.218 (5.5)	.187 (4.8)	.378 (9.6)	.400 (10.2)	.125 (3.2)	.050 (1.3)	.080 (2.0)	.250 (6.4)	
11015	11015-R	11015-B	3	.218 (5.5)	.187 (4.8)	.378 (9.6)	.400 (10.2)	.187 (4.7)	.035 (.89)	.080 (2.0)	.250 (6.4)	
11016	11016-R	11016-B	3	.218 (5.5)	.187 (4.8)	.378 (9.6)	.500 (12.7)	.125 (3.2)	.050 (1.3)	.080 (2.0)	.250 (6.4)	

* Terminal Material: Brass ASTM B16

STANDARD SOLDERLESS

SOLDERLESS CONNECTION



.175 (4.5)
Plug

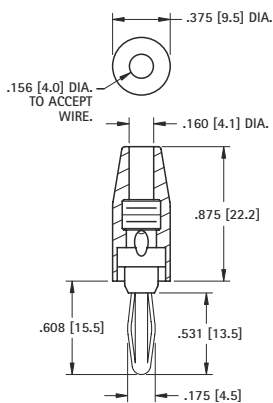

MATERIAL:
Spring: Nickel Silver
Body: Brass, Nickel Plate
Handle: Nylon

CAT. NO.	COLOR
6078	RED
6079	BLACK

SOLDERLESS WITH SET SCREW



.175 (4.5)
Plug

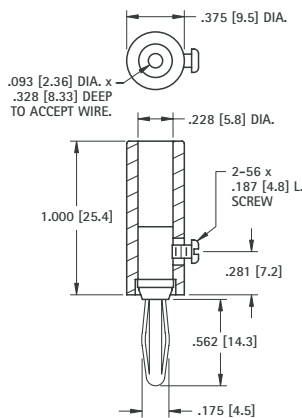

MATERIAL:
Spring: Nickel Silver
Body: Brass, Nickel Plate
Handle: Nylon

CAT. NO.	COLOR
6084	RED
6085	BLACK

SOLDERLESS CONNECTION



.175 (4.5)
Plug

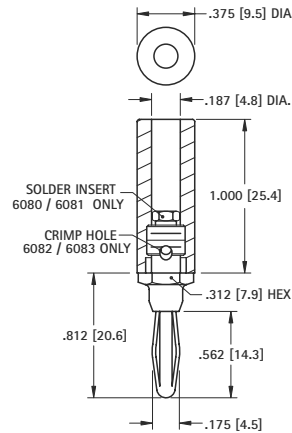

MATERIAL:
Spring: Phospor Bronze
Body: Brass, Nickel Plate
Handle: Nylon

RED CAT. NO.	BLACK CAT. NO.	WIRE CONNECTION
6080	6081	SOLDER
6082	6083	SOLDERLESS

EXTERNAL THREAD

SOLDER LUG



.175 (4.5)
Plug

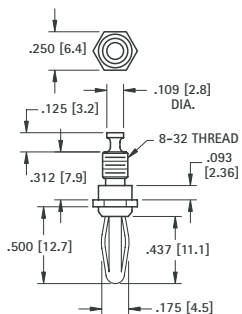

MATERIAL:
Spring: Beryllium Copper
Body: Brass, Nickel Plate

CAT. NO. 652

FOUR LEAF SPRING



.175 (4.5)
Plug

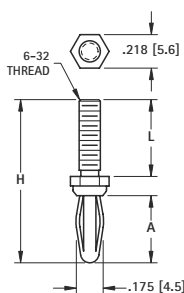

MATERIAL:
Spring: Beryllium Copper (Cat. No. 653)
Spring: Phospor Bronze (Cat. No. 654, 655)
Body: Brass, Nickel Plate

CAT. NO.	H	L	A
653	1.062 (27.0)	.500 (12.7)	.437 (11.1)
654	.937 (24.7)	.188 (4.8)	.550 (14.0)
655	1.250 (31.8)	.500 (12.7)	.550 (14.0)

BARREL SPRING



.175 (4.5)
Plug

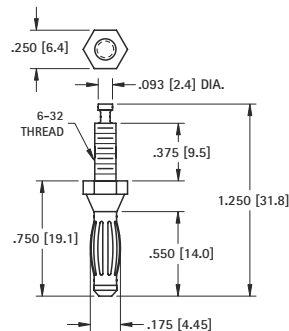

MATERIAL:
Spring: Beryllium Copper
Body: Brass, Nickel Plate

CAT. NO. 657

STANDARD RIVET



.175 (4.5)
Plug

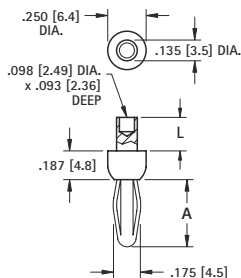

MATERIAL:
Four Leaf Spring: Phospor Bronze,
*Barrel Spring, Beryllium Copper
Body: Brass, Nickel Plate

CAT. NO.	L	A	SPRING
552-3	.187 (4.7)	.437 (11.1)	4 leaf
658	.187 (4.7)	.550 (14.0)	barrel
552-4	.218 (5.5)	.437 (11.1)	4 leaf

INTERNAL THREAD



Supplied with screw and lug
Unassembled

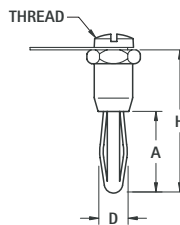

MATERIAL:
Four Leaf Spring: Phospor Bronze,
*Barrel Spring, Beryllium Copper
Body: Brass, Nickel Plate

CAT. NO.	D	A	H	THREAD	SPRING
6072	.175 (4.4)	.531 (13.5)	.960 (24.4)	6-32	4 leaf
659*	.175 (4.4)	.550 (14.0)	.960 (24.4)	6-32	barrel
6073	.218 (5.5)	.437 (11.1)	1.120 (28.4)	10-32	4 leaf

EXTERNAL THREAD



Supplied with nut and lug
Unassembled

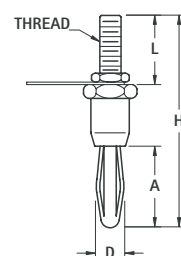

MATERIAL:
Spring: Phospor Bronze
Body: Brass, Nickel Plate

CAT. NO.	D	A	H	L	THREAD
6074-1	.175 (4.5)	.531 (13.5)	1.125 (28.6)	.375 (9.5)	6-32
6074-2	.175 (4.5)	.531 (13.5)	1.500 (38.1)	.750 (19.1)	6-32
6075	.300 (7.5)	.750 (19.1)	1.750 (44.5)	.625 (15.9)	1/4-28

BANANA PLUGS

MINIATURE PLUGS

SWAGE MOUNT



.120 (3.0) Plug

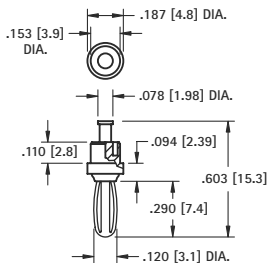

MATERIAL:
Spring: Beryllium Copper
Body: Brass, Silver Plate

CAT. NO. 452

THREADED



CAT. NO. 450

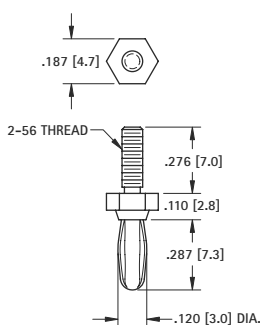

MATERIAL:
Spring: Beryllium Copper, Nickel Plate
Body: Brass, Silver Plate

SOLDER CONNECTION



.120 (3.0) Plug

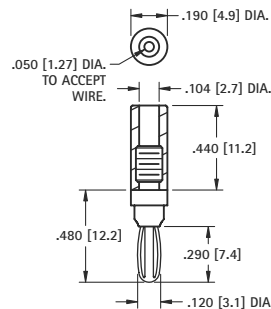

CAT. NO.	COLOR
6076	RED
6077	BLACK
451	NONE

MATERIAL:
Spring: Beryllium Copper, Nickel Plate
Body: Brass, Nickel Plate
Handle: Nylon

BANANA JACKS

INSULATED SOLDER CONNECTION



Accepts .175 (4.5) Plug

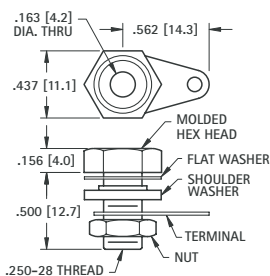

Supplied with hardware
 Unassembled

CAT. NO.	HEAD COLOR
6093	RED
6094	BLACK

MATERIAL:
Body: Brass, Nickel Plate
Terminal: Copper, Tinned
Hex Head: Phenolic

NON-INSULATED RECESSED HEAD

Fits panel up to .312 (7.9)



Accepts .175 (4.5) Plug

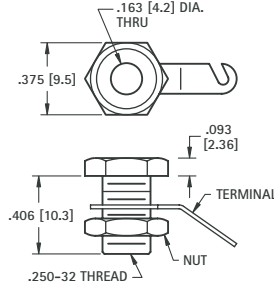

Supplied with nut and lug.
 Unassembled

CAT. NO. 6095

MATERIAL:
Current Rating: 15 Amps
Body: Brass, Nickel Plate
Terminal: Brass, Tin Plate

NON-INSULATED MINIATURE JACK



Accepts .120 (3.0) Plug

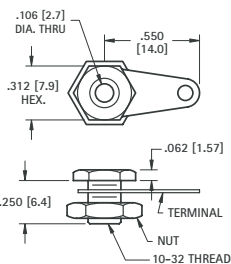

Supplied with lug and nut.
 Unassembled

CAT. NO. 6090

MATERIAL:
Body: Brass, Nickel Plate
Terminal: Copper, Tinned

FULLY INSULATED



Accepts .175 (4.5) Plug

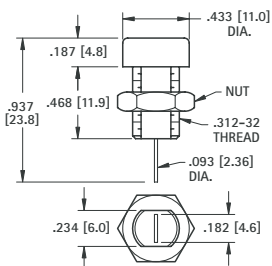

CAT. NO.	COLOR
6091	RED
6092	BLACK

MATERIAL:
Body: Nylon
Contact: Brass, Tin Plate

NON-INSULATED STANDARD HEAD

Fits panel up to .375 (9.6)



Accepts .175 (4.5) Plug

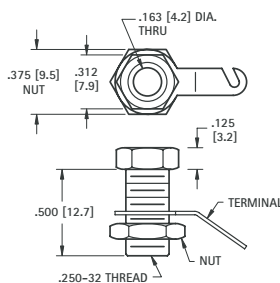

Supplied with nut and lug.
 Unassembled

CAT. NO. 6096

MATERIAL:
Current Rating: 15 Amps
Body: Brass, Nickel Plate
Terminal: Brass, Tin Plate

NON-INSULATED

MINIATURE

Accepts .120 (3.0) Plug

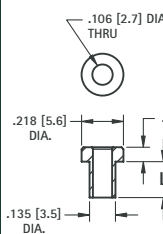

MATERIAL:
 Brass, Tin Plate

CAT. NO.	L
476-2	.125 (3.2)
476-3	.165 (4.2)
476-4	.187 (4.7)

STANDARD

Accepts .175 (4.5) Plug

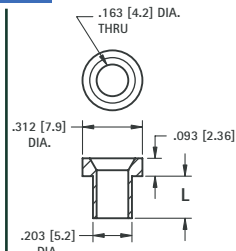

MATERIAL:
 Brass, Nickel Plate

CAT. NO.	L
575-4	.218 (5.5)
575-6	.265 (6.7)
575-8	.350 (8.9)

BANANA PLUGS & JACKS

SURFACE MOUNT AUDIO JACKS

- Mates with 2.5mm and 3.5mm plugs
- Designed for reliable interface with audio equipment including computer speakers, headphones, sound cards, cell phones, etc.
- Models available for mono and stereo applications
- Low profile, surface mount design

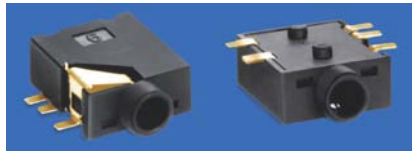

SPECIFICATIONS

Housing: Polyamide, UL Rated 94V-0
Ground Terminal: .012 (.30) Brass, Gold Flash ①
Spring Contacts: .008 (.20) Phosphor Bronze, Gold Flash ② ⑤
Shunt Terminals: .012 (.30) Brass, Gold flash ③ ④

FOR 2.5 mm PLUGS

SUPPLIED ON TAPE AND REEL

FOR 3.5 mm PLUGS

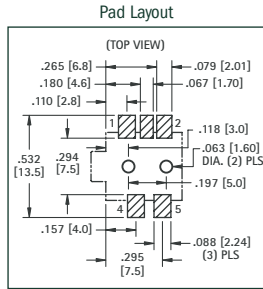
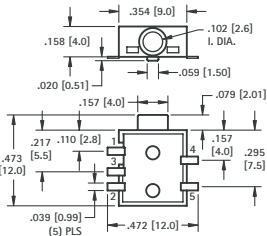

STEREO SCHEMATIC

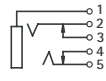

MONO SCHEMATIC

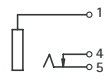

CAT. NO. 980TR (Stereo)

CAT. NO. 982TR (Mono)

Tape Spec's: 24mm wide; 16mm pitch
Reel Spec's: 15 inch reel (1,000 pieces per reel)

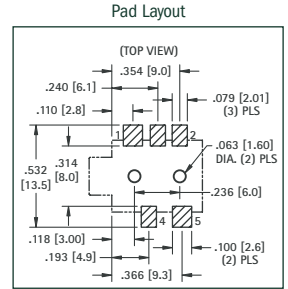
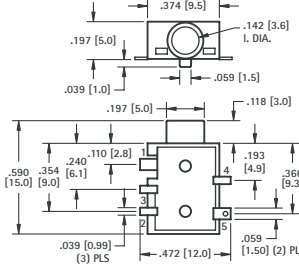

CAT. NO. 981TR (Stereo)

CAT. NO. 983TR (Mono)

Tape Spec's: 24mm wide; 16mm pitch
Reel Spec's: 15 inch reel (800 pieces per reel)

BINDING POSTS

All Keystone binding posts are designed to prevent accidental contact with current carrying parts. They feature a "limited opening" captivated head to insure safety. Ideal for audio circuitry, R.F. circuitry, oscilloscopes, power supplies and various other applications.

These multi-purpose binding posts feature high current rating, captivated heads and anti-rotation stud mounting.

Note: Binding Posts accept .175" (4.5) Banana Plugs, .080" (2.08) Tip Plugs, Spade Lugs, Alligator Clips, Wires and EZ hooks.

STANDARD BINDING POST

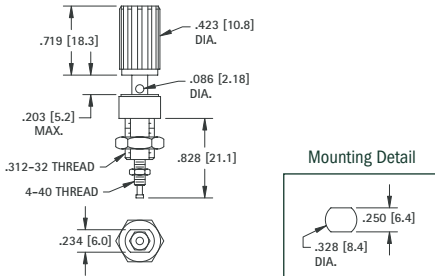

Mounting Detail

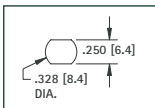

For panels up to .281 (7.1) thick

CAT. NO.	COLOR
7004	RED
7005	BLACK

MATERIAL:

Stud: Brass per QQ-B-626
Plating: Silver Plate
Insulation: Nylon
Current Rating: 15 Amps
Stud to Panel Capacitance: 3.3 pF Nominal

UNINSULATED BINDING POST

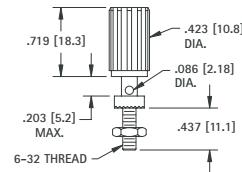

For panels up to .313 (8.0) thick

CAT. NO.	COLOR
7006	RED
7007	BLACK

MATERIAL:

Stud: Brass per QQ-B-626
Plating: Nickel Plate
Insulation: Nylon
Current Rating: 15 Amps, 1000V AC Working

STANDARD DUAL HEX HEAD

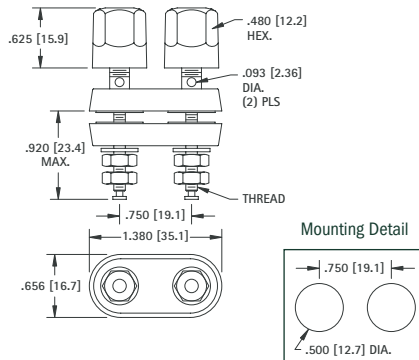

Mounting Detail

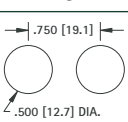

GOLD PLATE		NICKEL PLATE	
CAT. NO.	THREAD	CAT. NO.	THREAD
4108	8-32	7018	8-32
4109	10-32	7019	10-32

MATERIAL:

Stud: Brass per ASTM B-16.
Insulation: Nylon
Current Rating: 30 Amps, 1000V AC Working

STANDARD HEX HEAD

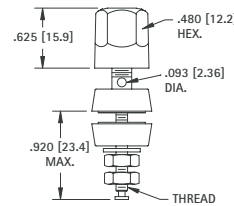

Mounting Detail

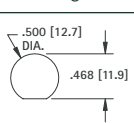

GOLD PLATE			NICKEL PLATE		
CAT. NO.	THREAD	COLOR	CAT. NO.	THREAD	COLOR
4096	8-32	RED	4091	8-32	RED
4097	8-32	BLACK	4092	8-32	BLACK
7016	10-32	RED	4093	10-32	RED
7017	10-32	BLACK	4094	10-32	BLACK
7023	10-32	WHITE	4198	10-32	WHITE
7024	10-32	YELLOW	4199	10-32	YELLOW

MATERIAL:

Stud: Brass per ASTM B-16.
Insulation: Nylon
Current Rating: 30 Amps, 1000V AC Working

TRANSISTOR INSULATORS

- Rapid Heat Dissipation • High Dielectric Strength • Low Cost

These precision stamped mica insulators provide good thermal conductivity: Excellent thermal resistance 1100°F (593°C) Dielectric constant of 7 at 1000 KHz. .009 watts per square inch per degree celsius per inch in thickness.

MATERIAL: .003 (.08) ± .001 (.02) Thick Mica

FOR TO-3 CASES

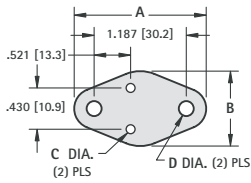

CAT. NO.	A	B	C	D
4651	1.625 (41.3)	1.093 (27.8)	.093 (2.36)	.166 (4.2)
4652	1.560 (39.6)	1.050 (26.7)	.203 (5.15)	.171 (4.4)
4653	1.655 (42.1)	1.063 (27.0)	.166 (4.2)	.166 (4.2)
4636	1.655 (42.1)	1.063 (27.0)	.052 (1.32)	.166 (4.2)
4644	1.655 (42.1)	1.063 (27.0)	.270 (6.9)	.166 (4.2)

FOR THREADED STUD TRANSISTORS

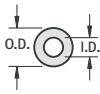

CAT. NO.	ID Inside Dia.	OD Outside Dia.	For Screw Size
4678	.120 (3.1)	.375 (9.5)	4
4679	.144 (3.7)	.375 (9.5)	6
4680	.171 (4.3)	.500 (12.7)	8
4681	.196 (5.0)	.625 (15.9)	10
4682	.260 (6.6)	.750 (19.0)	1/4
4683	.328 (8.3)	.875 (22.2)	5/16

FOR TO-66 CASES

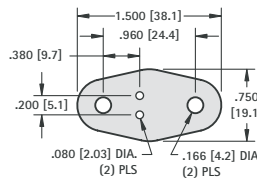

CAT. NO. 4664

CAT. NO. 4666

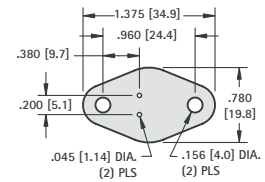

FOR TO-3 CASES

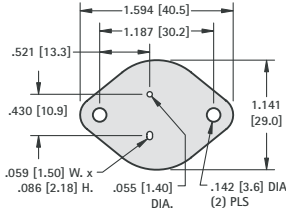

CAT. NO. 4662

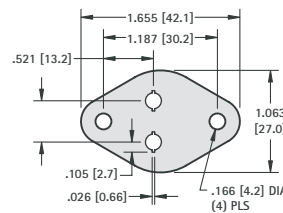

CAT. NO. 4667

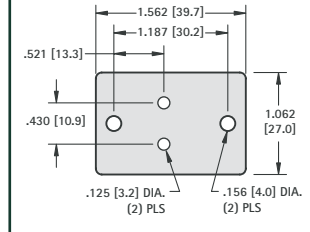

CAT. NO. 4661

FOR PLASTIC CASE

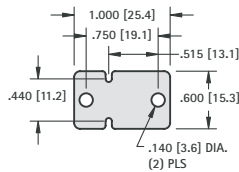

CAT. NO. 4663

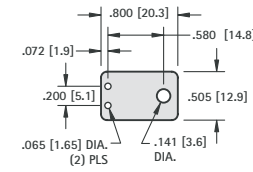

CAT. NO. 4671

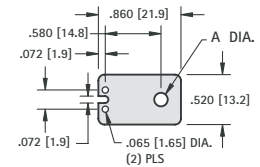

CAT. NO.	A
4672	.141 (3.6)
4673	.115 (2.9)

TRANSISTOR MOUNTING KITS

- Complete Kits or Individual Hardware • Pre-Packaged • Uniform Hardware at Low Cost

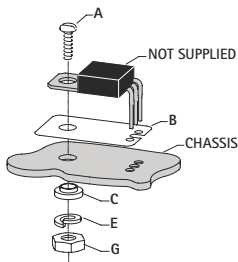

FOR TO-220 CASE

CAT. NO. 4724 Complete Mounting Kit			
ITEM	CAT. NO.	DESCRIPTION	QTY.
A	4690	4-40 Screw	1
B	4672	Mica Insulator	1
C	3049	Shoulder Washer	1
E	4693	Lockwasher	1
G	4694	4-40 Nut	1

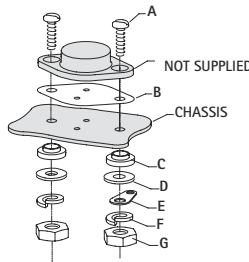

FOR TO-3 CASE

CAT. NO. 4725 Complete Mounting Kit			
ITEM	CAT. NO.	DESCRIPTION	QTY.
A	4696	6-32 Screw	2
B	4651	Mica Insulator	1
C	4698	Shoulder Washer	2
D	4699	Metal Washer	2
E	4004	Solder Terminal	1
F	4700	Lockwasher	2
G	4701	6-32 Nut	2

FOR TO-66 CASE

CAT. NO. 4726 Complete Mounting Kit			
ITEM	CAT. NO.	DESCRIPTION	QTY.
A	4696	6-32 Screw	2
B	4666	Mica Insulator	1
C	4698	Shoulder Washer	2
D	4699	Metal Washer	2
E	4004	Solder Terminal	1
F	4700	Lockwasher	2
G	4701	6-32 Nut	2

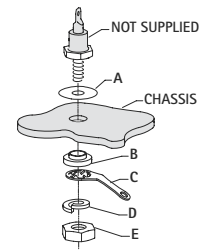

FOR DO-4, TO-59, TO-60, TO-62 CASES

CAT. NO. 4729 Complete Mounting Kit			
ITEM	CAT. NO.	DESCRIPTION	QTY.
A	4681	Mica Insulator	1
B	4702	Shoulder Washer	1
C	4704	Solder Terminal	1
D	1477	Lockwasher	1
E	4705	10-32 Nut	1

FOR DO-5, TO-48, TO-61 CASES

CAT. NO. 4730 Complete Mounting Kit			
ITEM	CAT. NO.	DESCRIPTION	QTY.
A	4682	Mica Insulator	1
B	4711	Shoulder Washer	1
C	4712	Solder Terminal	1
D	1476	Lockwasher	1
E	4713	1/4-28 Nut	1

These pre-packaged universal mounting kits provide all the necessary hardware and insulators required to securely mount the semiconductor to the chassis. Purchase the complete kit consisting of all hardware included in one package. Your choice of individual items available in 100 piece packages. Semiconductors customer supplied.

SOCKETS FOR T0-5 & T0-100

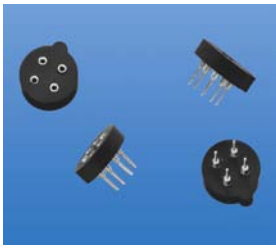

Fully molded compact construction. Speeds transistor assembly. Incorporates ultra high quality, closed entry, sleeve type contacts. Accepts .016 (.41) to .020 (.51) diameter leads or .010 (.25) x .018 (.46) rectangular transistor leads.

MATERIAL:

Insulator: Glass Filled Polyester, UL Rated 94V-0

Contact Pin: Brass, Tin-Lead Plate

RoHS (Non-RoHS Compliant)

Contact Spring: Beryllium Copper, .000030 min. Gold Plate

CAT. NO.	FOR	PINS
4590	T0-5	3
4591	T0-5	4
4592	T0-5	8
4593	T0-100	8
4594	T0-100	10

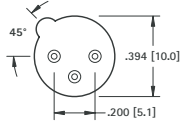

Cat. No. 4590

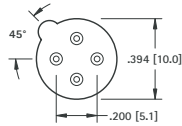

Cat. No. 4591

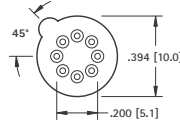

Cat. No. 4592

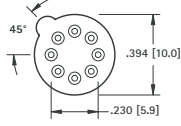

Cat. No. 4593

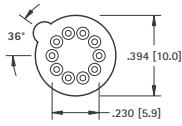

Cat. No. 4594

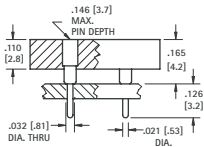

POWER TRANSISTOR MOUNTS

Molded barrier insulators functionally replaces up to six pieces of conventional insulation required with previous methods of mounting power transistors. Built-in barrier eliminates need for sleeving of connections.

NOTE: #6-20 mounting screw available **CAT. NO. 4706**

For T0-3 CASES

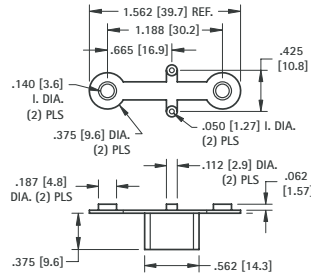

MATERIAL: Nylon 6/6, UL Rated 94V-2

CAT. NO. 4616

HEAVY DUTY T0-3

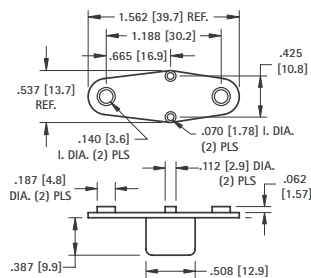

MATERIAL: Glass filled Polyester, UL Rated 94V-0

CAT. NO. 4626

For T0-66 CASES

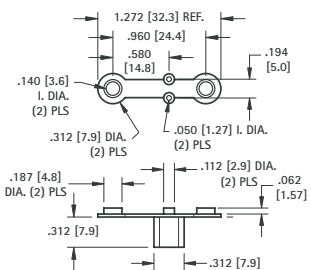

MATERIAL: Nylon 6/6, UL Rated 94V-2

CAT. NO. 4617

"MINI" HALOGEN LAMP SOCKETS

- Accepts .022 (.032) to .032 (.81) diameter Pins or Leads
- The Wire Wrap Pins can be easily bent to achieve a variety of positions

SPECIFICATIONS

Base: Glass Filled LCP; **Contact:** Beryllium Copper, Gold Plate; **Shell:** Brass, Nickel Plate

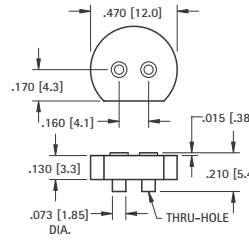

CAT. NO. 4595

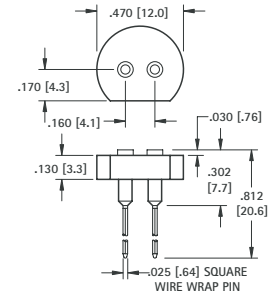

CAT. NO. 4596

T0-3 SOCKET FOR PC BOARDS



Easily assembles onto printed circuit board. Eliminates wiring. Stops on PC terminals provide sufficient spacing between socket and PC board to permit proper assembly of transistor to socket. Can be screwed down tightly to heat sink.

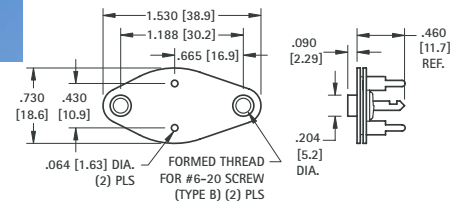

Bottom View Mounting Detail

MATERIAL:

Top Plate: Molded Nylon

Base: Phenolic

Contacts: Brass, Tin Plate

Collector Plate: Steel, Tin Plate

CAT. NO. 4600

NYLON T0-3 CASE COVERS

Molded nylon covers easily mount over and insulate the power transistor. Will withstand temperatures to approximately 250°F (107°C).

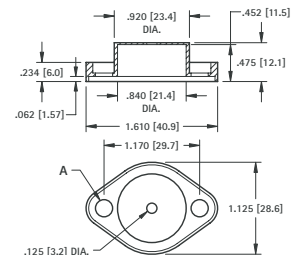

MATERIAL: Nylon 6/6, UL Rated 94V-2

CAT. NO.	FOR	EYELETS INSTALLED	A
4632	T0-3	NONE	.210 (5.4)
4634	T0-3	TWO	.140 (3.6)

SOCKETS FOR TO-3 CASE



VARIOUS MOLDED BOSS HEIGHTS

MATERIAL:
Base: Phenolic, Grade PBE, Type XP
Contacts: Brass, Tin Plate
Top Plate: Nylon, ASTM-D4066
 Phenolic, Grade PBE, Type XP
 (Cat. No. 4606 only)
Collector Plate: Steel, Tin Plate



Socket and transistor are assembled to chassis at same time, using the minimum amount of hardware. Top molded boss ensure the transistor leads will be isolated from the chassis. Various boss heights available to accommodate different chassis thicknesses.

Socket is installed onto chassis using eyelets or screws. Transistor is installed afterwards. Assembly and repairs are simplified since socket will stay in place without transistor mounted. Top molded boss or added bushing ensure the transistor leads will be isolated from the chassis. Various boss heights available to accommodate standard chassis thicknesses. Use Cat. No. 4606 and nylon bushings for special chassis thicknesses.

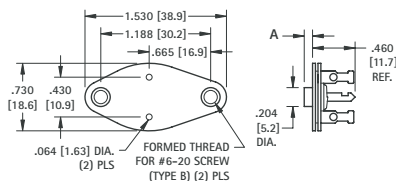

CAT. NO.	A DIM.
4603	.030 (.76)
4602	.045 (1.14)
4601	.090 (2.29)

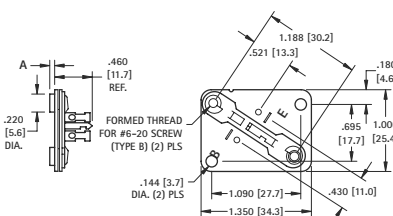

CAT. NO.	A DIM.
4606	NONE
4607	.030 (.76)
4608	.045 (1.14)
4609	.060 (1.52)
4618	.125 (3.2)

FULLY MOLDED TO-3 SOCKET



Pre-assembling the socket to the chassis by eyelets or rivets permits the installation of the semiconductor at a later stage in the assembly. The molded top boss eliminates hardware.

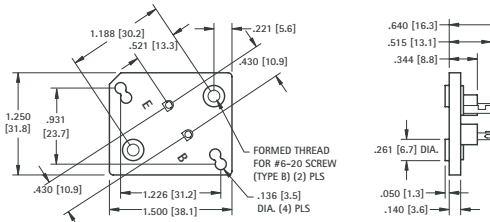

MATERIAL:
Base: Molded Nylon 6/6
Contacts: Brass, Tin Plate
Collector Plate: Steel, Tin Plate

CAT. NO. 4620

HEAVY DUTY SOCKET FOR TO-3 CASE

CHOICE OF SINGLE OR DUAL COLLECTOR SOLDER TABS

Features an all-in-one mounting plate and solder tabs, providing complete electrical isolation of the solder tab connections. Rated 5 Amps DC continuous and 15 Amps DC Intermittent

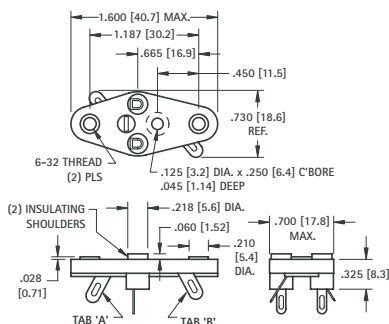

MATERIAL:
Base: Glass Filled Polyester, UL Rated 94V-0
Contacts: Brass, Tin Plate
Collector Plate: Brass, Tin Plate

With transistor lead-in insulating shoulders

CAT. NO.	WITH TAB
4513	"A" ONLY
4514	"A" & "B"

Less transistor lead-in insulating shoulders

CAT. NO.	WITH TAB
4515	"A" ONLY
4516	"A" & "B"

TO-3 CASE MOUNTING KITS

These socket kits provide everything needed to mount a transistor onto a chassis in one kit. Nylon bushings or boss will insulate transistor leads from chassis. Mica insulator isolates transistor from chassis. Two 6-20 screws included to mount transistor. (Transistor not included)

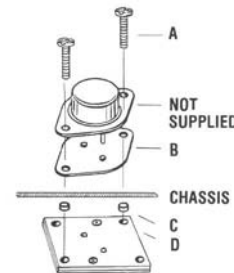
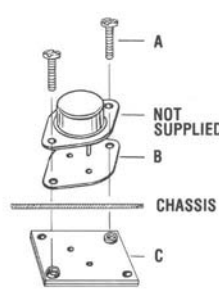
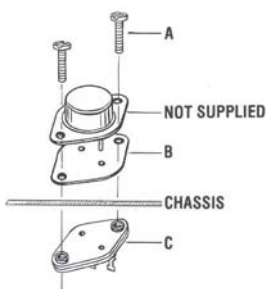

CAT. NO. 4732 Complete Mounting Kit				
ITEM	CAT. NO.	DESCRIPTION	QUANTITY	
A	4706	6-20 screws	2	
B	4651	Mica Insulator	1	
C	4602	Socket	1	

CAT. NO. 4733 Complete Mounting Kit				
ITEM	CAT. NO.	DESCRIPTION	QUANTITY	
A	4706	6-20 screws	2	
B	4651	Mica Insulator	1	
C	4608	Square Socket	1	

CAT. NO. 4734 Complete Mounting Kit				
ITEM	CAT. NO.	DESCRIPTION	QUANTITY	
A	4706	6-20 screws	2	
B	4651	Mica Insulator	1	
C	4684	Nylon Bushing	4	
D	4606	Square Socket	1	

THIS DOCUMENT IS THE PROPERTY OF KEYSTONE ELECTRONICS CORP. AND SHALL NOT BE REPRODUCED, DISTRIBUTED OR USED AS A BASIS FOR MANUFACTURE WITHOUT PRIOR WRITTEN PERMISSION FROM KEYSTONE ELECTRONICS CORP.

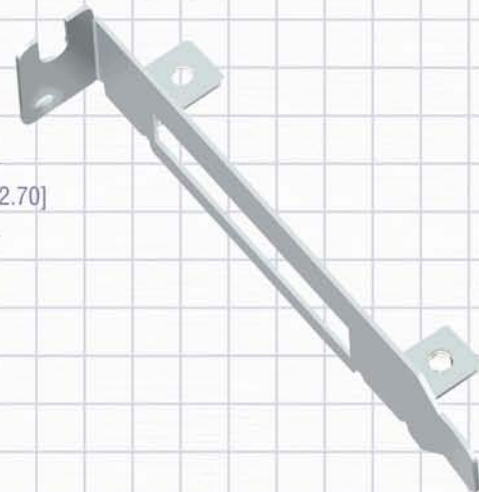
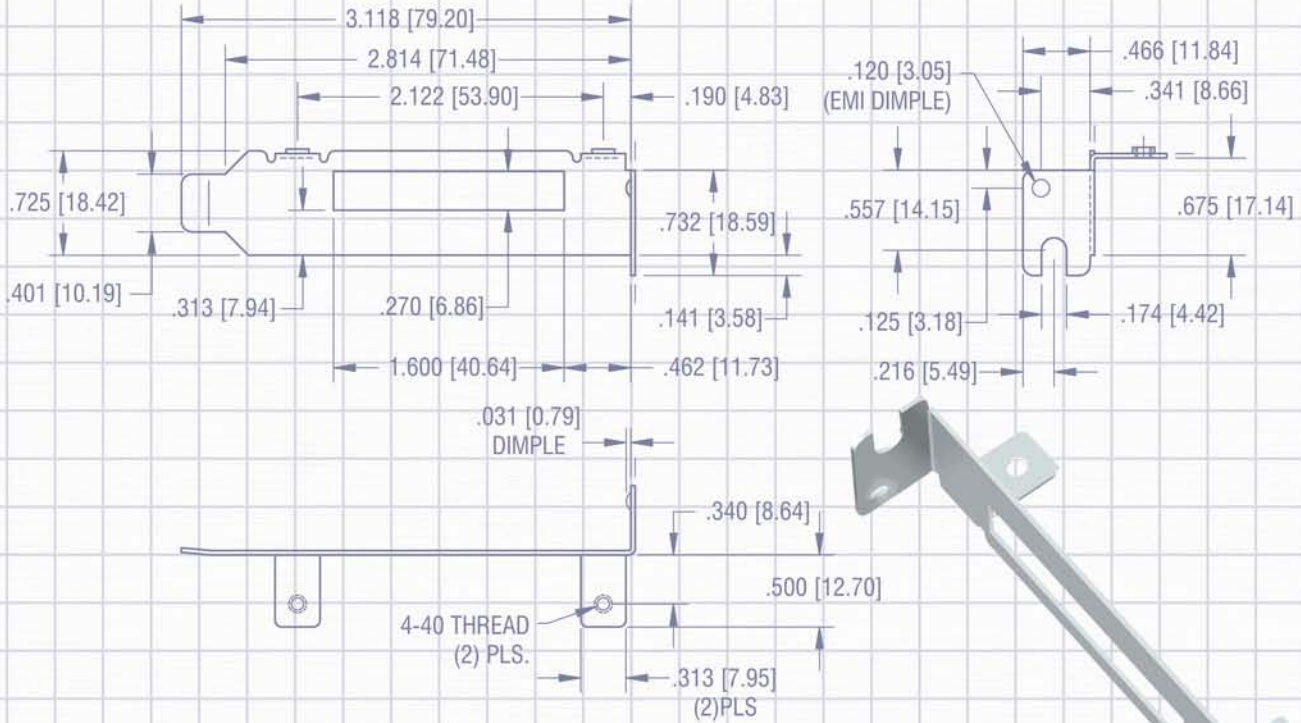
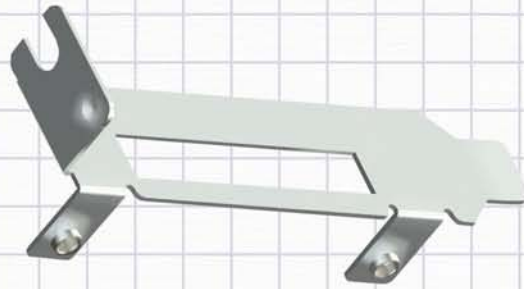

PC BOARD HARDWARE

We offer an assortment of standard blank and cutout computer brackets, PCB support brackets, card edge ejectors and guides to provide the right solution for applications such as:

- Computer Chassis Assembly
- Electronic Peripheral Equipment
- Rack Mounted Equipment
- Printed Circuit Board Mounting
- Printed Circuit Board Supports
- Printed Circuit Board insertion and removal
- To dress up chassis access panels

Our quality system is ISO 9001:2008 certified. Our products are in compliance with the RoHS and REACH directives. We provide 3D modeling, CAD and other application-engineering support for modifications, special designs or assembly requirements to assist you in choosing the right Keystone product for your application..

DATE

DESCRIPTION

REV.

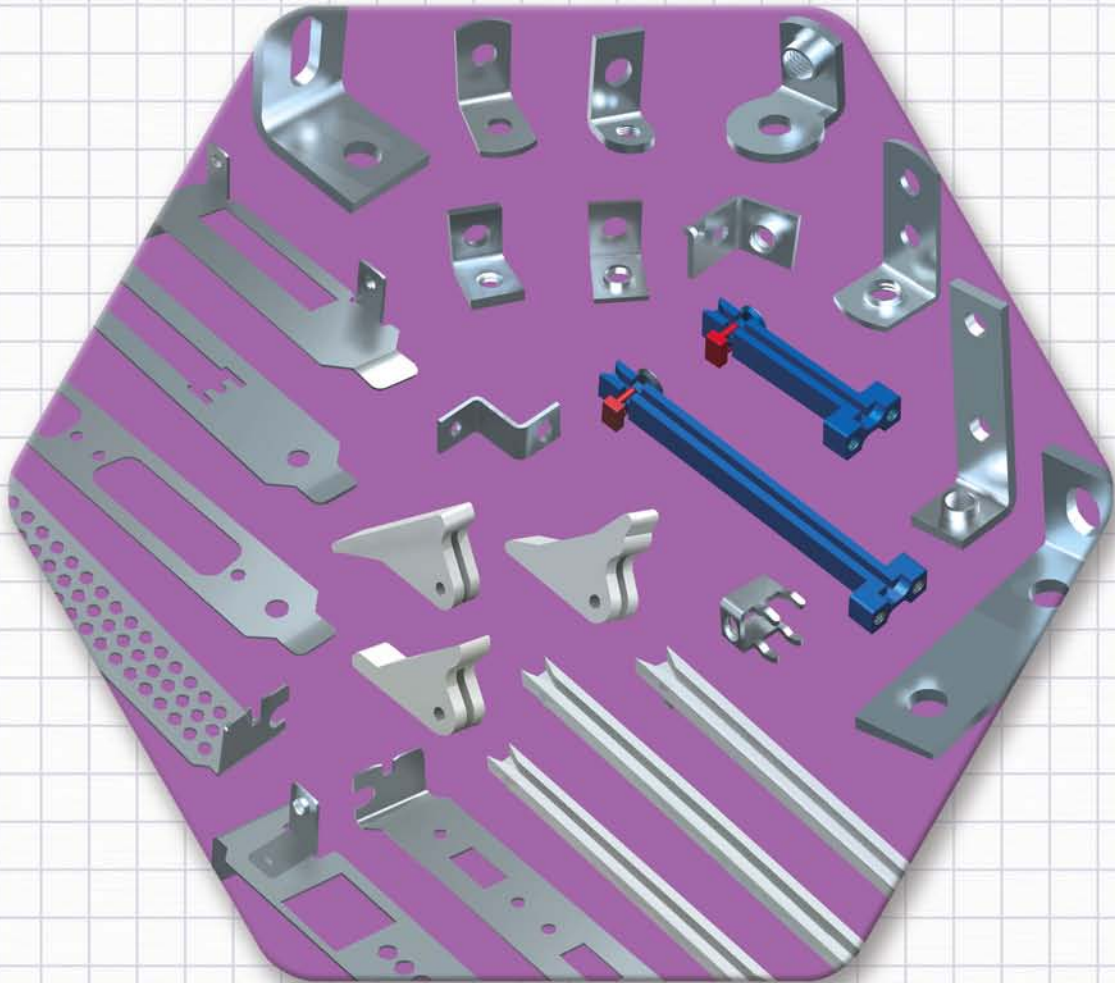

SECTION CONTENTS

COMPUTER BRACKETS	118-121
COMPUTER BRACKET WORKSHEET	122
CONTACT PINS	123
MOUNTING BRACKETS	114-115
PC BOARD ACCESSORIES	
Board Guides.....	116-117
Card Ejectors	116
IC Static Tray Clips	116
PUSH-IN TERMINALS	123

THREADED MOUNTING BRACKETS

THREADED MOUNTING BRACKETS

4-40 THREAD

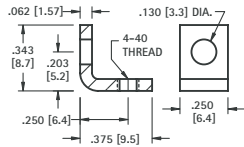

CAT. NO. 612

MATERIAL:
.062 (1.57) Steel, Zinc Plate

4-40 THREAD

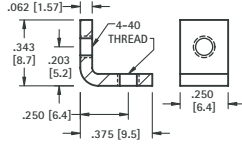

CAT. NO. 621

MATERIAL:
.062 (1.57) Steel, Zinc Plate

4-40 THREAD

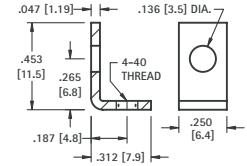

CAT. NO. 616

MATERIAL:
.047 (1.19) Brass, Tin Plate

6-32 THREAD

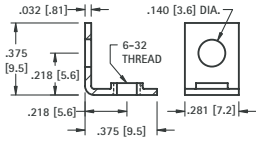

CAT. NO. 634

MATERIAL:
.032 (.81) Brass, Nickel Plate

6-32 THREAD

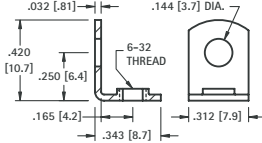

CAT. NO. 614

MATERIAL:
.032 (.81) Brass, Tin Plate

6-32 THREAD

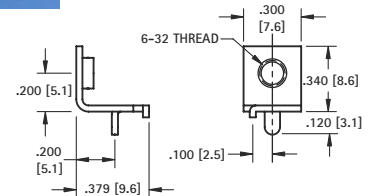

CAT. NO. 632

MATERIAL:
.032 (.81) Brass, Tin Plate

6-32 THREAD

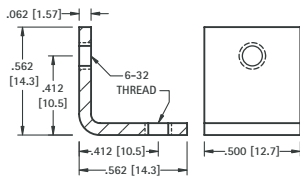

CAT. NO. 4334

MATERIAL:
.062 (1.57) Steel, Nickel Plate

6-32 THREAD

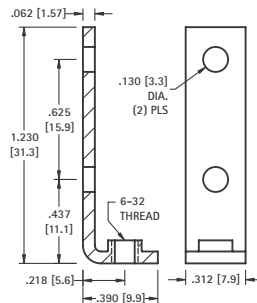
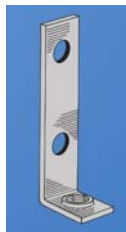

CAT. NO. 708

MATERIAL:
.062 (1.57) Steel, Nickel Plate

6-32 THREAD

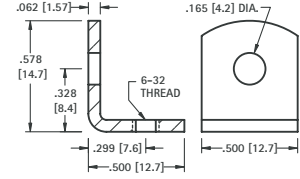

CAT. NO. 617

MATERIAL:
.062 (1.57) Steel, Tin Plate

6-32 OR 8-32 THREAD

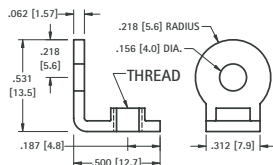

CAT. NO.	THREAD
4332	6-32
4333	8-32

MATERIAL:
.062 (1.57) Brass, Nickel Plate

8-32 THREAD

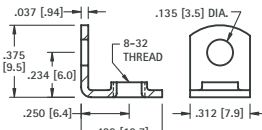

CAT. NO. 611

MATERIAL:
.037 (.94) Brass, Tin Plate

8-32 THREAD

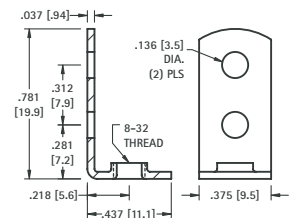

CAT. NO. 631

MATERIAL:
.037 (.94) Steel, Tin Plate

SNAP-IN THREADED PC MOUNT BRACKETS

- Snaps in for wave soldering • Reduces assembly time • Easily mount into predrilled or punched holes • Stable no rock design

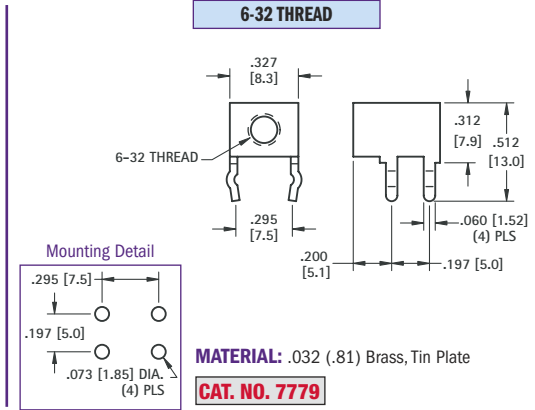
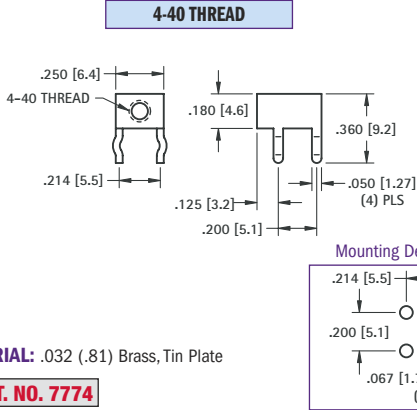
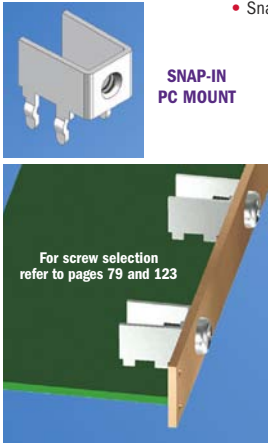

UNIVERSAL CLEAR HOLE BRACKETS

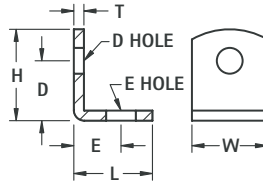
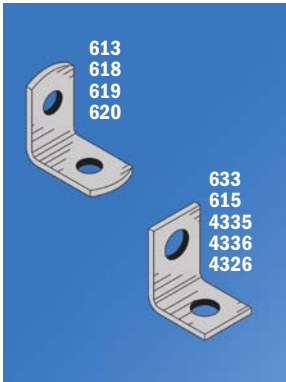

CAT. NO.	H	L	W	D	D HOLE DIAMETER	E	E HOLE DIAMETER	T	MATERIAL	FINISH
633	.375 (9.5)	.375 (9.5)	.281 (7.1)	.218 (5.5)	.140 (3.6)	.218 (5.5)	.140 (3.6)	.032 (.81)	Brass	Nickel
613	.390 (9.9)	.453 (11.5)	.375 (9.5)	.234 (5.9)	.147 (3.7)	.299 (7.6)	.128 (3.3)	.032 (.81)	Brass	Nickel
615	.420 (10.7)	.343 (8.7)	.281 (7.1)	.281 (7.1)	.144 (3.7)	.203 (5.2)	.128 (3.3)	.032 (.81)	Brass	Tin
4335	.562 (14.3)	.562 (14.3)	.500 (12.7)	.412 (10.5)	.120 (3.0)	.411 (10.4)	.120 (3.0)	.062 (1.57)	Steel	Nickel
4336	.562 (14.3)	.562 (14.3)	.500 (12.7)	.412 (10.5)	.144 (3.7)	.412 (10.5)	.144 (3.7)	.062 (1.57)	Steel	Nickel
618	.628 (16.0)	.628 (16.0)	.375 (9.5)	.378 (9.6)	.169 (4.3)	.378 (9.6)	.169 (4.3)	.050 (1.27)	Brass	Tin
619	.687 (17.4)	.687 (17.4)	.375 (9.5)	.500 (12.7)	.144 (3.7)	.500 (12.7)	.144 (3.7)	.032 (.81)	Steel	Tin
4326	1.013 (25.7)	.487 (12.4)	.312 (7.9)	.816 (20.7)	.140 (3.6)	.332 (8.4)	.140 (3.6)	.050 (1.27)	Steel	Nickel
620	1.156 (29.4)	.656 (16.7)	.375 (9.5)	.906 (23.0)	.169 (4.3)	.420 (10.7)	.169 (4.3)	.032 (.81)	Steel	Tin

BOARD BRACKETS



Originally designed for our line of standardized terminal boards; these brackets can also be used in other applications. See pages 148-149 for Turret Terminal Boards.

MATERIALS: .062 (1.57) Steel, Nickel Plate

CAT. NO.	W	L	S
1570	.281 (7.1)	1.187 (30.1)	.750 (19.1)
1556	.375 (9.5)	1.625 (41.3)	1.000 (25.4)
1571	.281 (7.1)	1.625 (41.3)	1.187 (30.1)
1567	.375 (9.5)	2.125 (54.0)	1.500 (38.1)
1568	.375 (9.5)	2.625 (66.7)	2.000 (50.8)
1569	.375 (9.5)	3.125 (79.4)	2.500 (63.5)

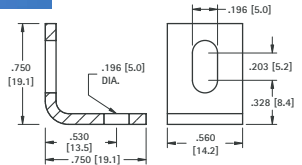
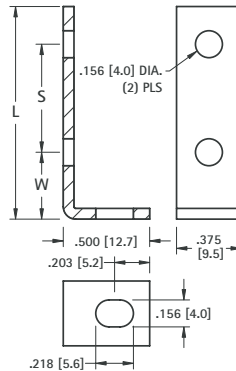

CAT. NO. 4337 **MATERIAL:** .080 (2.03) Aluminum

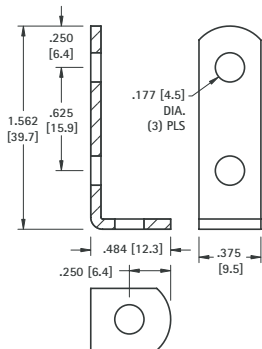

CAT. NO. 1564 **MATERIAL:** .062 (1.57) Steel, Nickel Plate

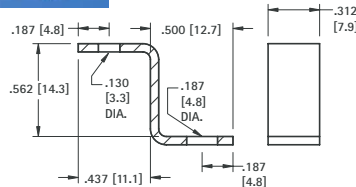

CAT. NO. 4325 **MATERIAL:** .050 (1.27) Steel, Nickel Plate

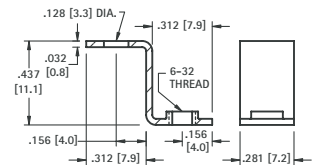

CAT. NO. 630 **MATERIAL:** .032 (.81) Brass, Tin Plate

LEVER ACTION PC CARD EJECTORS

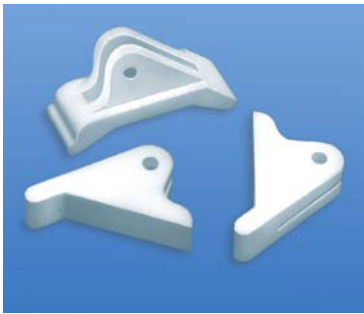

Card ejectors offer a simple and reliable way of installing and ejecting circuit boards. Card ejectors reduce the stress on board connectors by improper removal of board. Ejectors also protect components

on board from damage during removal or installation. Ejectors supplied with stainless steel pin to assure quick assembly of ejector to card.

- Designed for .062 (1.57) PC cards.
- Level action ejectors aids card insertion and extraction.
- Supplied complete with stainless steel spring pin.

MATERIAL:
White Nylon 6/6, UL Rated 94V-2

CARD MOUNTING DIMENSIONS

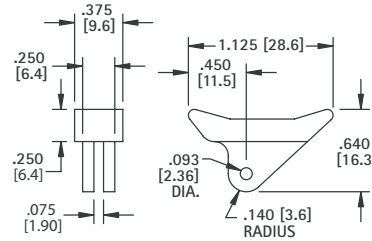
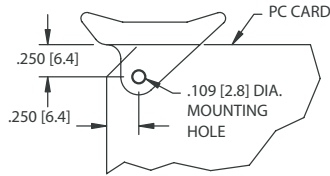

CAT. NO. 8640

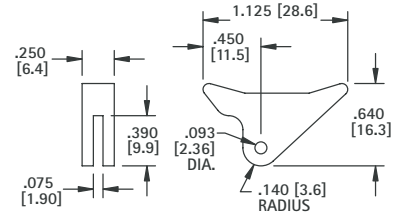

CAT. NO. 8641

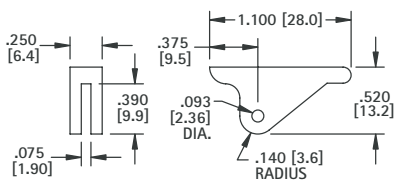

CAT. NO. 8642

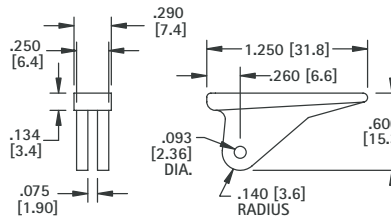

CAT. NO. 8643

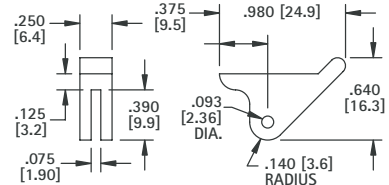

CAT. NO. 8644

HORIZONTAL TYPE PC BOARD GUIDES



Guides may be used horizontally or vertically and snap into .125 (3.2) diameter holes. Narrow width allows maximum density and optimum airflow. Simple press-fit, secure installation. No special tools required to install.

- Sturdy Nylon construction
- Mounts into chassis with out tools
- Assures proper alignment of board
- Quick and easy installation of board.

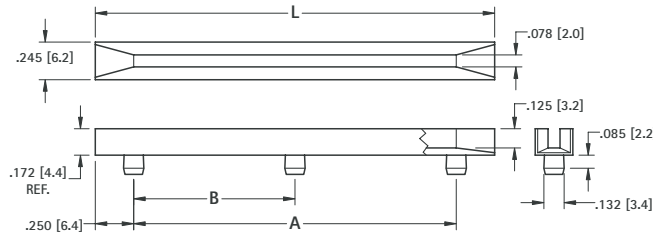

Mounting Detail

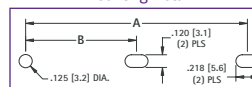

MATERIAL:
Natural Nylon 6/6, UL Rated 94V-2

CAT. NO.	L	A	B
8620	2.5 (63.5)	2.0 (50.8)	-
8621	3.0 (76.2)	2.5 (63.5)	-
8622	3.5 (88.9)	3.0 (76.2)	-
8623	4.0 (101.6)	3.5 (88.9)	-
8624	4.5 (114.3)	4.0 (101.6)	-
8625	5.0 (127.0)	4.5 (114.3)	-
8626	5.5 (139.7)	5.0 (127.0)	-
8627	6.0 (152.4)	5.5 (139.7)	-
8628	6.5 (165.1)	6.0 (152.4)	-
8629	7.0 (177.8)	6.5 (165.1)	-
8630	7.0 (177.8)	6.5 (165.1)	3.25 (82.6)
8631	7.5 (190.5)	7.0 (177.8)	-
8632	7.5 (190.5)	7.0 (177.8)	3.50 (88.9)
8633	8.0 (203.2)	7.5 (190.5)	-
8634	8.0 (203.2)	7.5 (190.5)	3.75 (95.3)
8635	8.5 (215.9)	8.0 (203.2)	-
8636	8.5 (215.9)	8.0 (203.2)	4.00 (101.6)

VERTICAL PC BOARD GUIDES

Vertical board guides provide for a quick and easy assembly of circuit boards. Sturdy design assures boards stay square. These guards can be mounted to chassis or directly to a mother board. Mounting holes have brass threaded inserts to assure secure mounting of guide. After bracket is installed, boards are quickly locked into place or released for repair or upgrades. Locking pins at the top of the bracket can be set/released using finger pressure, no tools are required.

- Brass threaded inserts assure sturdy connection to chassis or mother board.
- Available for circuit boards 1.970" to 6.300" tall.
- Locking pin keeps circuit board locked into place.
- M3 mounting screws available.
- All brackets use same footprint, no redesign of mounting holes required if changing bracket height.

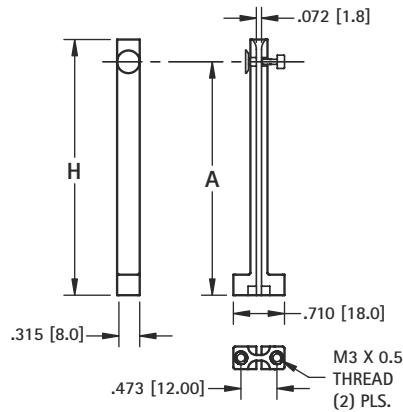
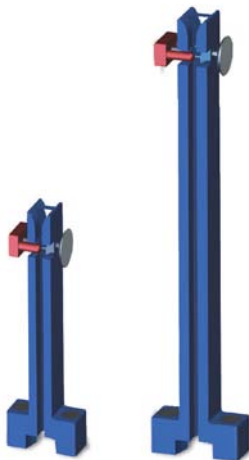
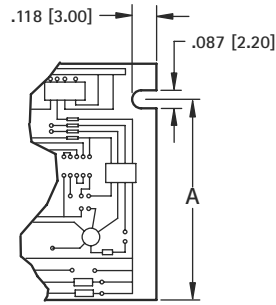

CAT. NO.	H HEIGHT	A LOCK PIN HEIGHT
8645	1.970 (50.0)	1.650 (42.0)
8646	2.560 (65.0)	2.250 (56.5)
8647	3.540 (90.0)	3.200 (81.5)
8648	4.725 (120.0)	4.430 (112.5)

MATERIAL:
Guide: Nylon
Threaded Insert: Brass, Nickel plate

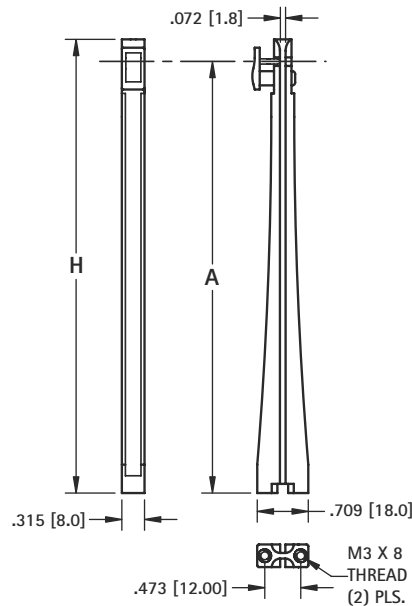

CAT. NO.	H HEIGHT	A LOCK PIN HEIGHT
8649	6.300 (160.0)	6.000 (152.0)

MATERIAL:
Guide: Polystyrene
Threaded Insert: Brass, Nickel plate

PC BOARD GUIDES

M3 MOUNTING SCREW

- Pan head screw
- Available in four lengths to accommodate most board thicknesses
- Flat washer available: P/N 4693

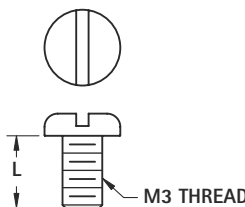

CAT. NO.	L
29311	6.00
29314	12.00
29316	16.00
29318	25.00

MATERIAL: Steel, Zinc plate

STANDARD BLANK BRACKETS

These computer brackets have been designed to accommodate a large variety of board sizes and heights. Available with tabs located properly for ESA/EISA or PCI formats. Blanks can be machined or stamped for prototype or low volume production. All brackets are nickel plated for a clean look and a protective finish. Standard cut-outs can be added to these blanks to suit your specific production needs. See page 118-119 for standard cut-outs and design worksheet.

- Premium quality
- Designed to fit all PC computers height brackets available
- Blanks available for "fillers"
- Fast delivery and cost effective tooling for special designs

MATERIAL: .032 (.81) Steel, Matte Nickel Plate.

EISA/ISA

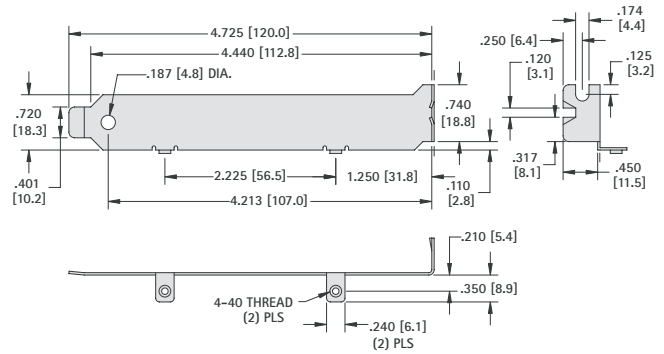

CAT. NO. 9202

PCI

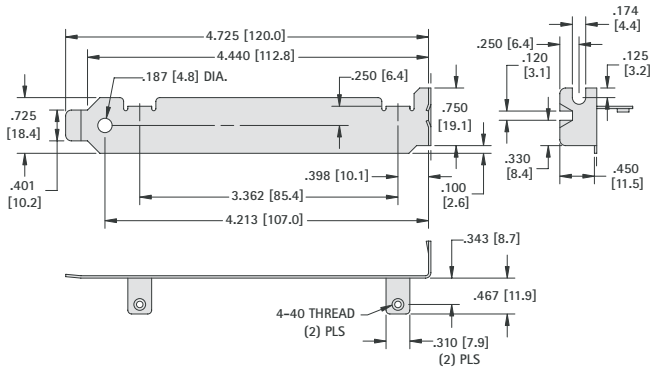

CAT. NO. 9203

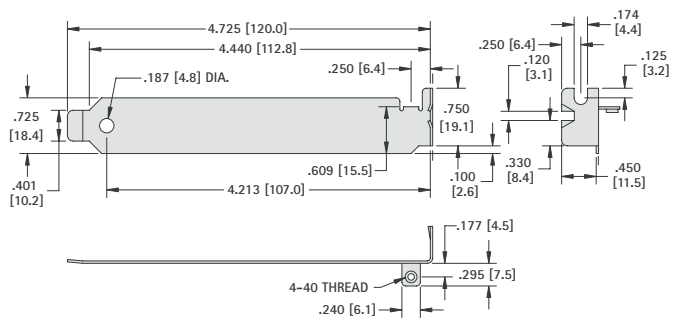

CAT. NO. 9204

EISA/ISA or PCI

- Reinforced with rib for extra strength

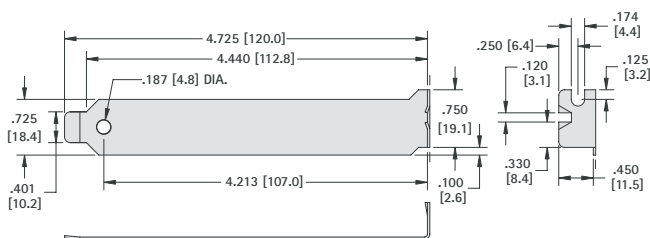

CAT. NO. 9200

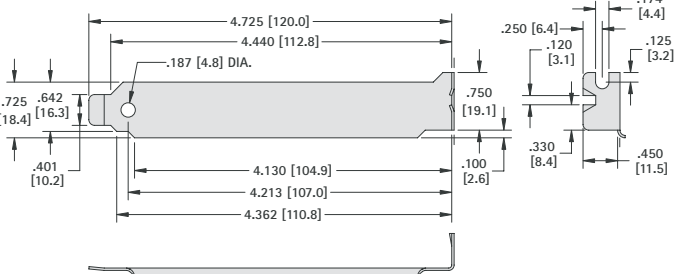

P/N 9201

CAT. NO. 9201

STANDARD BLANK BRACKETS

EISA/ISA

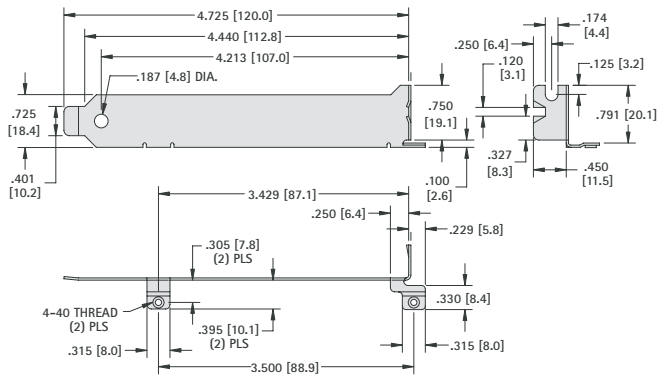

CAT. NO. 9205

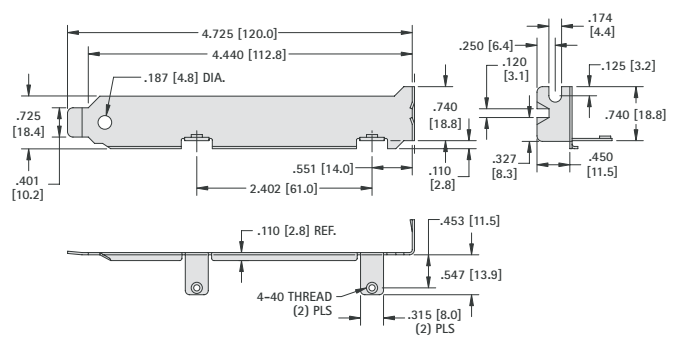

CAT. NO. 9206

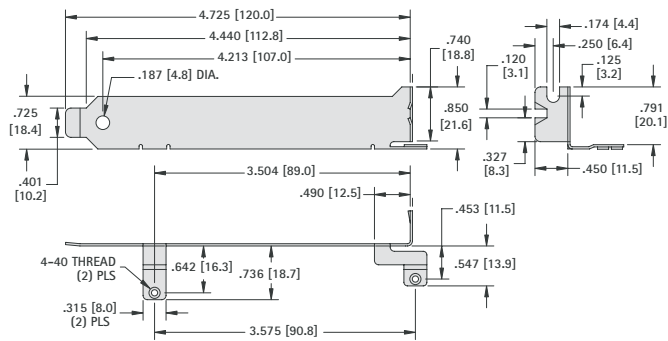

CAT. NO. 9207

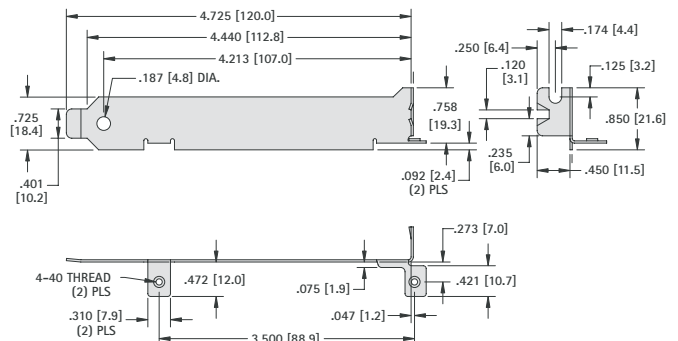

CAT. NO. 9208

LOW PROFILE BLANK BRACKETS

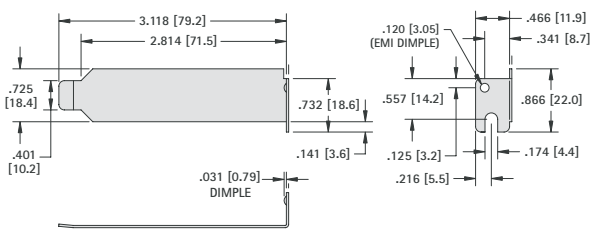

CAT. NO. 9230

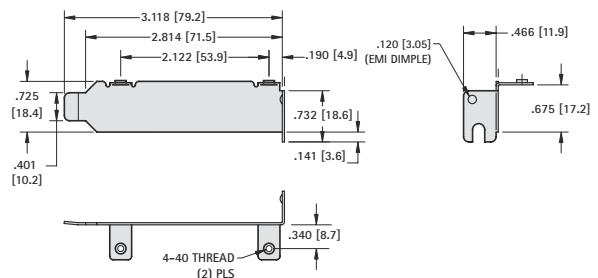

CAT. NO. 9231

STANDARD COMPUTER BRACKETS

D-SUB

These computer brackets have been designed with a variety of holes and cutouts to connect most peripherals. The brackets shown reflect the most common configurations for most applications. If our standard brackets do not fit your

production requirements, we can fabricate a bracket to your exact specifications. Refer to pages 122 - 123 for blank dimensions and page 126 for standard cutout dimensions.

- Peripherals
- Video Cards
- Parallel/Serial Ports
- External Hard Drives
- External CD Drives

9 PIN

For Bracket Dimensions Refer to Cat. No. 9200

EISA/ISA

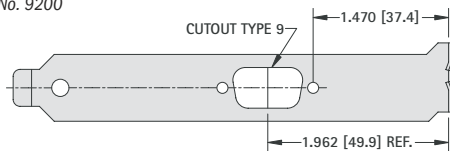

CAT. NO. 9200-1

For Bracket Dimensions Refer to Cat. No. 9200

PCI

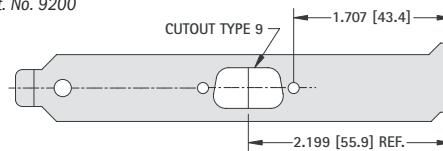

CAT. NO. 9200-2

For Bracket Dimensions Refer to Cat. No. 9207

EISA/ISA

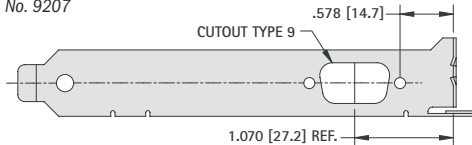

CAT. NO. 9207-1

For Bracket Dimensions Refer to Cat. No. 9200

EISA/ISA

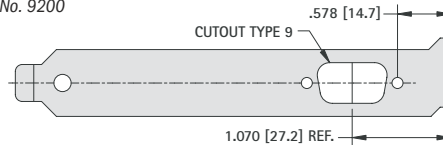

CAT. NO. 9200-16

15 PIN

For Bracket Dimensions Refer to Cat. No. 9200

EISA/ISA

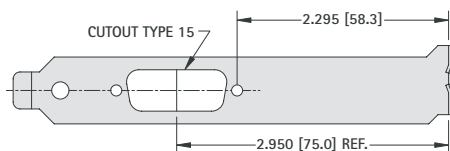

CAT. NO. 9200-3

For Bracket Dimensions Refer to Cat. No. 9200

EISA/ISA

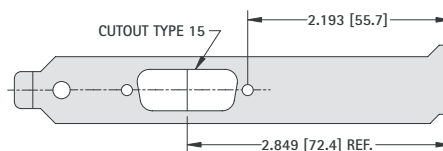

CAT. NO. 9200-11

25 - 37 PIN

For Bracket Dimensions Refer to Cat. No. 9200

EISA/ISA - 25 PIN

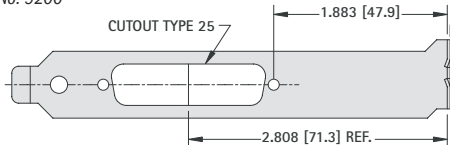

CAT. NO. 9200-4

For Bracket Dimensions Refer to Cat. No. 9200

EISA/ISA - 37 PIN

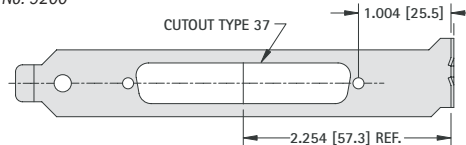

CAT. NO. 9200-5

50 PIN

For Bracket Dimensions Refer to Cat. No. 9200

EISA/ISA - 50 PIN

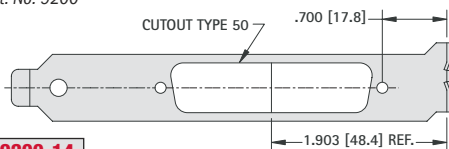

CAT. NO. 9200-14

VENT

EISA/ISA OR PCI

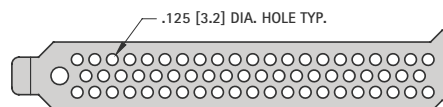

CAT. NO. 9200-19

LOW PROFILE ACCESS PORT

For Bracket Dimensions Refer to Cat. No. 9231

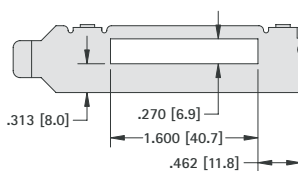

CAT. NO. 9231-1

MULTIPLE D-SUB

For Bracket Dimensions
Refer to Cat. No. 9200

EISA/ISA

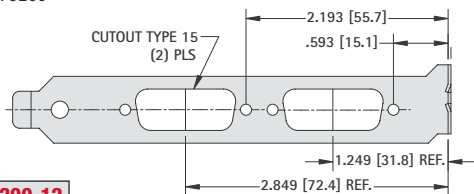

CAT. NO. 9200-12

For Bracket Dimensions
Refer to Cat. No. 9200

EISA/ISA

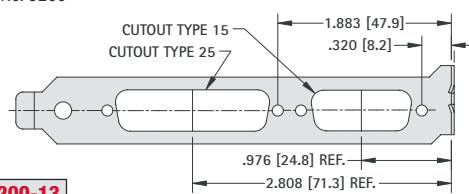

CAT. NO. 9200-13

For Bracket Dimensions
Refer to Cat. No. 9200

EISA/ISA

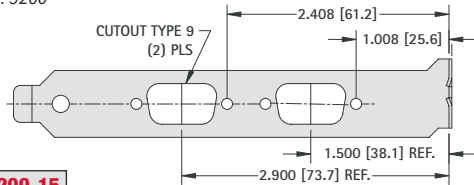

CAT. NO. 9200-15

For Bracket Dimensions
Refer to Cat. No. 9200

EISA/ISA

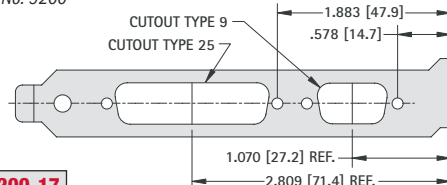

CAT. NO. 9200-17

SCSI

For Bracket Dimensions
Refer to Cat. No. 9200

SCSI 1 - 50 PIN

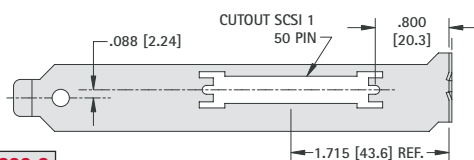

CAT. NO. 9200-6

For Bracket Dimensions
Refer to Cat. No. 9200

SCSI 2, 3 & 4 - 50 PIN

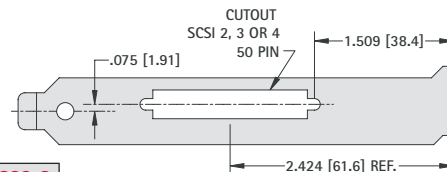

CAT. NO. 9200-8

For Bracket Dimensions
Refer to Cat. No. 9200

SCSI 1 - 68 PIN

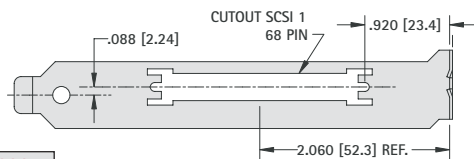

CAT. NO. 9200-7

For Bracket Dimensions
Refer to Cat. No. 9200

SCSI 2, 3 & 4 - 68 PIN

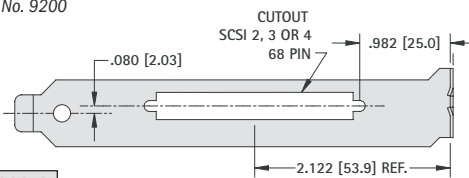

CAT. NO. 9200-9

PERIPHERAL

For Bracket Dimensions
Refer to Cat. No. 9204

EISA/ISA

SOUND CARDS

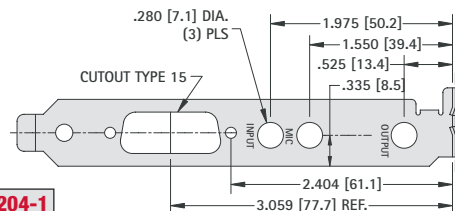

CAT. NO. 9204-1

For Bracket Dimensions
Refer to Cat. No. 9203

PCI

ISDN/PC FAX

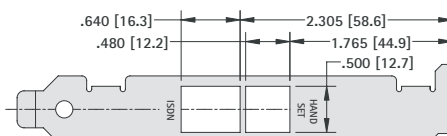

CAT. NO. 9203-1

For Bracket Dimensions
Refer to Cat. No. 9201

PCI

VIDEO CARDS

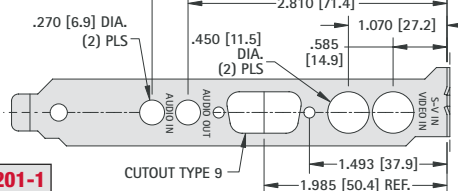

CAT. NO. 9201-1

For Bracket Dimensions
Refer to Cat. No. 9202

EISA/ISA

FAX - MODEM

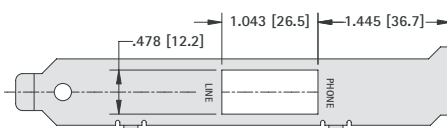

CAT. NO. 9202-1

For Bracket Dimensions
Refer to Cat. No. 9200

EISA/ISA OR PCI

USB

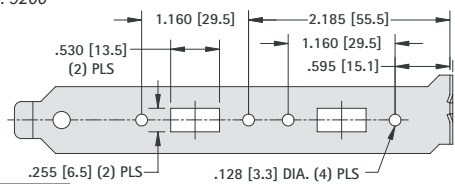

CAT. NO. 9200-10

For Bracket Dimensions
Refer to Cat. No. 9203

PCI

NETWORK

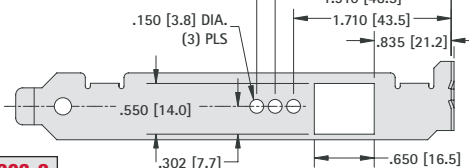

CAT. NO. 9203-2

EISI/ISA or PCI

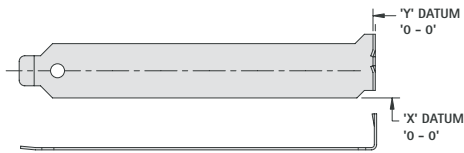

- CAT. NO. 9200**
- CAT. NO. 9201** (Ribbed)
- CAT. NO. 9230**

PCI with TABS

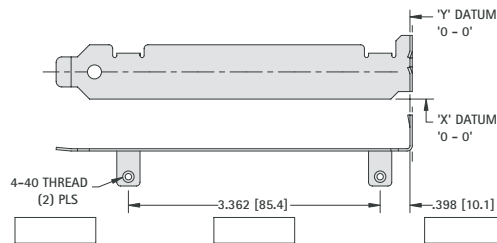

CAT. NO. 9203

EISA/ISA with TABS

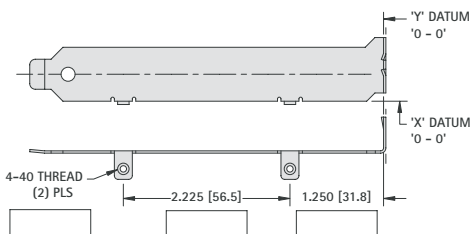

CAT. NO. 9202

EISA/ISA with TABS

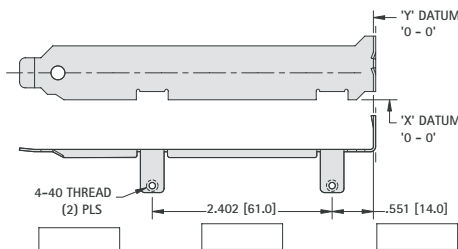

CAT. NO. 9206

EISA/ISA with TABS

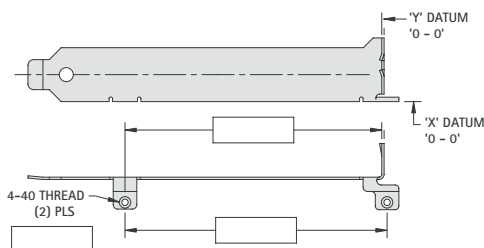

- CAT. NO. 9205**
- CAT. NO. 9207**

EISA/ISA with TABS

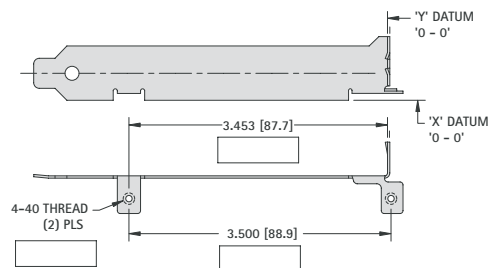

CAT. NO. 9208

LOW PROFILE with TABS

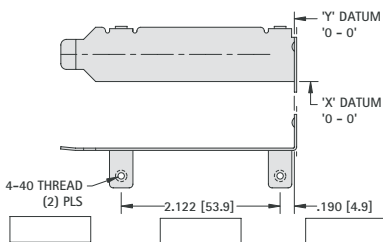

CAT. NO. 9231

PCI with TAB

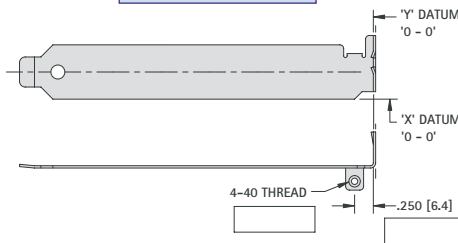

CAT. NO. 9204

NOTE: Refer to pages 114 and 115 for overall blank dimensions

If you do not have your own drawing, please use the worksheet provided.

- STEP 1:** Select a standard blank configuration PCI or EISA/ISA, with or without tabs.
- STEP 2:** If you've selected a standard blank with tabs and the tab locations do not meet your requirements, indicate the dimensions in the boxes.
- STEP 3:** Place your standard panel cutouts (Ex: DB9) on your selected drawing.
- STEP 4:** Use Datum's X and Y on drawing, to indicate the precise location of the center lines of the cutout(s).
- STEP 5:** For stamped identification markings indicate the approximate location(s).
- STEP 6:** Quantities Required: _____
If you have any questions, please contact our application engineers.

Name: _____ Title: _____

Company: _____

Address: _____

Phone: _____ Fax: _____

For prompt quotations fax, mail or e-mail this worksheet.

MINIATURE TUBULAR TERMINALS



.062 (1.57) – .067 (1.70)
Mounting Holes

- Quick and Easy to Install
- For Production or Prototype
- Postive Locking In-Hole
- No Staking Required
- Holds .010 (.25) to .050 (1.27) Diameter Wire

These terminals are often used for transistor and Bi-Pin lamp sockets. Terminals snap into place and are firmly held without the need of staking. Wire leads can be inserted from either end.

Terminals **1236** and **1237** have tapered socket spring forming that will hold multiple leads in place. Terminals are pre-tinned for easy soldering.

INSERTION TOOL

For Arbor Press: **CAT. NO. TL-11**; For Hand Tool: **CAT. NO. 1214**

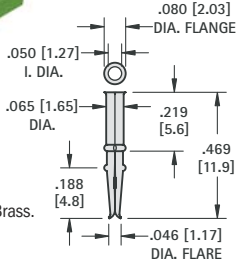
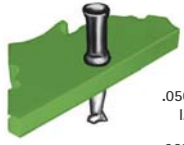

MATERIAL:
.006 (.15) Matte Tin, Brass.
Pre-Tinned

CAT. NO. 1236

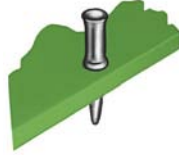

MATERIAL:
.006 (.15) Matte Tin, Brass.
Pre-Tinned

CAT. NO. 1237

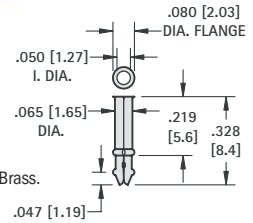
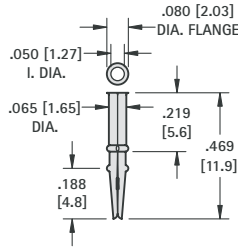

MATERIAL:
.006 (.15) Matte Tin, Brass.
Pre-Tinned

CAT. NO. 1238

“FLEA” CLIP



For subminiature applications where conventional terminals are too large or too costly. Ideal for quick repairs of printed circuitry. Simply insert wire through hole and it is held firmly by spring action assuring continued positive contact.

Mtg. Hole .062 (1.57)

Insertion Tool: **CAT. NO. 1322**

MATERIAL:
.008 (.20) Matte Tin, Beryllium
Copper, Tin Plate

CAT. NO. 1500

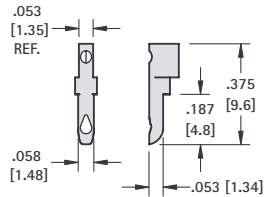

“IMP” TERMINAL



Excellent for point to point or feed thru wiring. Slot is serrated to grip component leads. Multiple connections are made quick and easy.

Mtg. Hole .062 (1.57)

Insertion Tool: **CAT. NO. 1322**

MATERIAL:
.008 (.20) Matte Tin, Beryllium
Copper, Tin Plate

CAT. NO. 1499FT

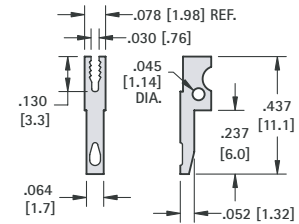

CLAMP TERMINAL



Terminal for production or prototype use. Holds as many as 7 leads without soldering, by spring action.

Mtg. Hole .093 (2.36)

Insertion Tool: **CAT. NO. 1323**

MATERIAL:
.015 (.38) Matte Tin, Spring Steel,
Tin Plate

CAT. NO. 1498CP

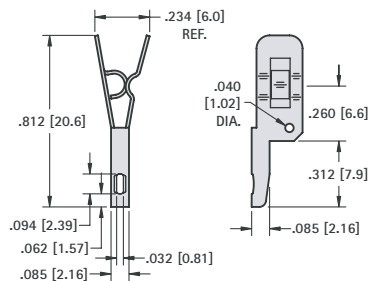

“MICRO” TERMINAL



Easily press-fit into a .042 (1.07) diameter hole may be flared for permanent installation. Ideally designed for use in circuitry to support components when space is at a premium.

Insertion Tool: **CAT. NO. 1322**

MATERIAL: .008 (.20) Matte Tin,
Beryllium Copper,
Tin Plate

CAT. NO. 1495

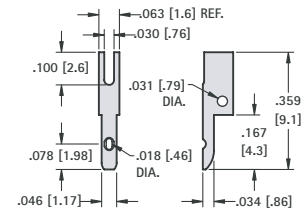

.025 SQUARE WIRE WRAP PINS

Completely burr free straight to within .003 (.08) per inch. Conical ends of square-wire with smooth blend-in radius on corners assures ease of insertion with minimum damage to pre-plated PCB holes.

CAT. NO.	L Length	CAT. NO.	L Length
5070	.400 (10.2)	5077	.642 (16.3)
5071	.440 (11.2)	5078	.675 (17.1)
5072	.515 (13.1)	5079	.720 (18.3)
5073	.535 (13.6)	5080	.850 (21.6)
5074	.600 (15.2)	5081	.916 (23.3)
5075	.615 (15.6)	5082	.995 (25.3)
5076	.625 (15.9)	5083	1.13 (28.7)

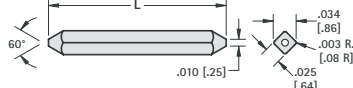

MATERIAL: Phosphor Bronze, Tin Plate

CONTACT PINS (SEAMLESS)

Pins can be staked to .062 (1.57) and .093 (2.36) thick boards.

CAT. NO.	A	B
1223	.093 (2.36)	.293 (7.4)
1224	.093 (2.36)	.357 (9.1)
1226	.093 (2.36)	.437 (11.1)
1200	.125 (3.18)	.379 (9.6)
1210	.125 (3.18)	.566 (14.4)
1230	.156 (3.96)	.379 (9.6)
1231	.156 (3.96)	.566 (14.4)

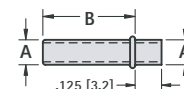

MATERIAL: Brass, Nickel Plate

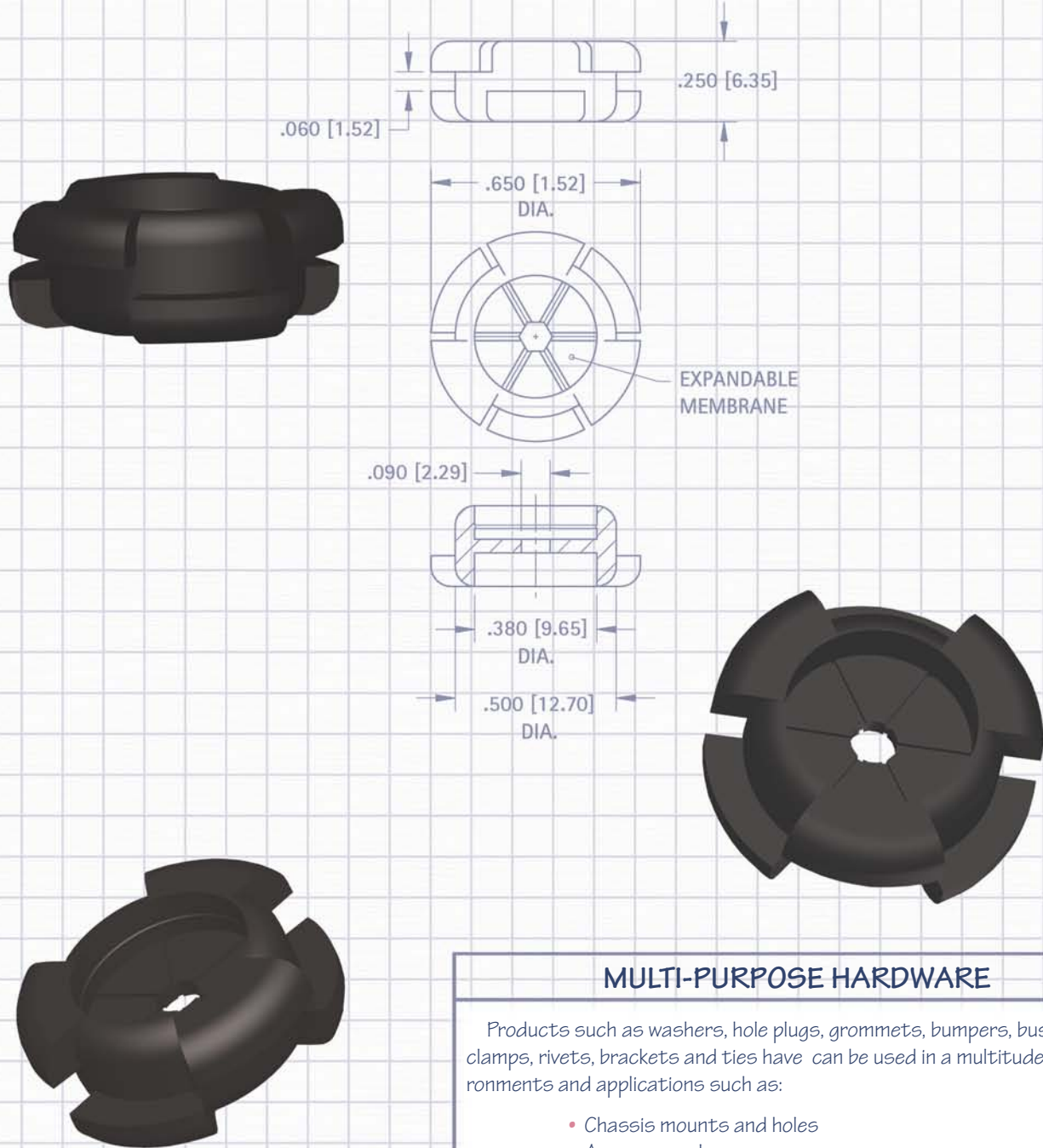

MULTI-PURPOSE HARDWARE

Products such as washers, hole plugs, grommets, bumpers, bushings, clamps, rivets, brackets and ties have can be used in a multitude of environments and applications such as:

- Chassis mounts and holes
- Access panels
- Wiring Outlets
- Electrical insulation
- Mechanical damping
- Cable/Fiber optic routing & securing
- PC board and electronic assemblies

Our quality system is ISO 9001:2008 certified. Our products are in compliance with the RoHS and REACH directives. We provide 3D modeling, CAD and other application-engineering support for modifications, special designs or assembly requirements to assist you in choosing the right Keystone product for your application.

DATE

DESCRIPTION

REV.



SECTION CONTENTS

CABLE MANAGEMENT

- Cable Clamps..... 126-127
- Cable Ties & Clips..... 127

CASE HARDWARE

- Anti-Vibration Grommets 129
- Bumpers & Feet..... 130
- Bushings, Nylon” 128
- Grommets, Rubber & Nylon” 129
- Hole plugs 128

TERMINALS

- Feed Thru 136-137
- Insulated Terminals 136-137
- Turret Terminals (Non-insulated) ... 138-139

TERMINAL BOARDS

- Turret 140-142
- Quick Fit..... 142
- Binding Post (Screw)..... 143
- Solder Terminal 143

UNIVERSAL HARDWARE

- Eyelets & Rivets 134
- Nuts 132
- Screws 133
- Tools 135
- Washers..... 131
- Washers, Retaining 131
- Washers, Shoulder 132

STEEL CABLE CLAMPS

Ideal for securing, grounding and routing cable, wiring, piping, tubing, components and fibre optics.

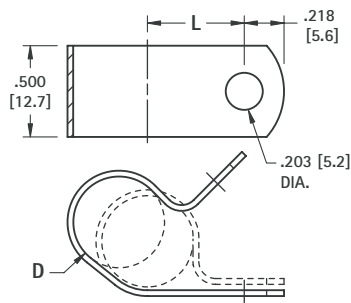

MATERIAL: .032 (.81) Steel, Zinc Plate

CAT. NO.	D FOR DIA.	L CTR TO CTR
8100	.187 (4.7)	.375 (9.5)
8101	.250 (6.4)	.406 (10.3)
8102	.312 (7.9)	.437 (11.1)
8103	.375 (9.5)	.468 (11.9)
8104	.437 (11.1)	.500 (12.7)
8105	.500 (12.7)	.531 (13.5)
8106	.562 (14.4)	.562 (14.3)
8107	.625 (15.9)	.594 (15.1)
8108	.687 (17.4)	.625 (15.9)
8109	.750 (19.0)	.656 (16.7)
8110	.812 (20.6)	.687 (17.4)
8111	.875 (22.2)	.718 (18.2)
8112	.937 (23.8)	.750 (19.1)
8113	1.00 (25.4)	.781 (19.8)

INSULATED STEEL CABLE CLAMPS

Ideal for securing, insulating and routing cable, wiring, piping, tubing, components and fibre optics.

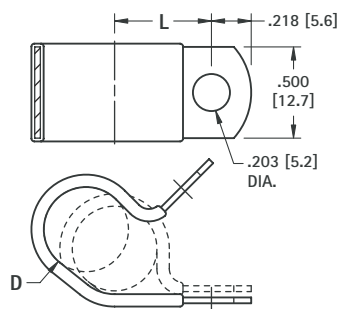

MATERIAL: .032 (.81) Steel, Zinc Plate
Cushion: Black Vinyl

CAT. NO.	D FOR DIA.	L CTR TO CTR
8121	.187 (4.7)	.406 (10.3)
8122	.250 (6.4)	.437 (11.1)
8123	.312 (7.9)	.468 (11.9)
8124	.375 (9.5)	.500 (12.7)
8125	.437 (11.1)	.531 (13.5)
8126	.500 (12.7)	.562 (14.3)
8127	.562 (14.3)	.594 (15.1)
8128	.625 (15.9)	.625 (15.9)
8129	.687 (17.4)	.656 (16.7)
8130	.750 (19.1)	.687 (17.4)
8131	.812 (20.6)	.718 (18.2)
8132	.875 (22.2)	.750 (19.1)
8133	.937 (23.8)	.781 (19.8)
8134	1.000 (25.4)	.812 (20.6)

STEEL HALF CLAMPS

Ideal for securing, grounding and routing cable, wiring, piping, tubing, components and fibre optics.

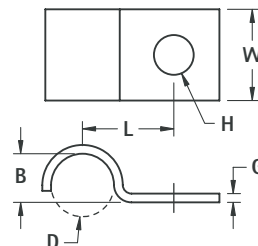
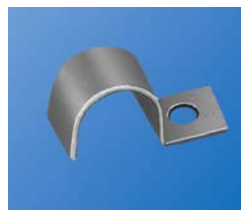

MATERIAL: Steel, Zinc Plate

CAT. NO.	D FOR DIA.	H HOLE DIA.	L CTR TO CTR	B	G THICK	W WIDTH
8140	.125 (3.2)	.218 (5.5)	.437 (11.1)	.125 (3.2)	.032 (.81)	.500 (12.7)
8141	.187 (4.7)	.218 (5.5)	.437 (11.1)	.156 (4.0)		
8142	.250 (6.4)	.218 (5.5)	.437 (11.1)	.187 (4.7)		
8143	.312 (7.9)	.218 (5.5)	.500 (12.7)	.250 (6.4)	.048 (1.22)	.500 (12.7)
8144	.375 (9.5)	.218 (5.5)	.531 (13.5)	.312 (7.9)		
8145	.437 (11.1)	.218 (5.5)	.562 (14.3)	.375 (9.5)		
8146	.500 (12.7)	.218 (5.5)	.625 (15.9)	.437 (11.1)	.060 (1.52)	.625 (15.9)
8147	.562 (14.3)	.218 (5.5)	.687 (17.4)	.500 (12.7)		
8148	.625 (15.9)	.218 (5.5)	.750 (19.1)	.562 (14.3)		
8149	.687 (17.4)	.218 (5.5)	.812 (20.6)	.625 (15.9)	.060 (1.52)	.625 (15.9)
8150	.750 (19.1)	.218 (5.5)	.812 (20.6)	.687 (17.4)		
8151	.812 (20.6)	.218 (5.5)	.875 (22.2)	.750 (19.1)		
8152	.875 (22.2)	.281 (7.1)	.937 (23.8)	.812 (20.6)	.060 (1.52)	.750 (19.1)
8153	.937 (23.8)	.281 (7.1)	.968 (24.6)	.812 (20.6)		
8154	1.000 (25.4)	.281 (7.1)	1.000 (25.4)	.937 (23.8)		

INSULATED STEEL HALF CLAMPS

Ideal for securing, insulating and routing cable, wiring, piping, tubing, components and fibre optics.

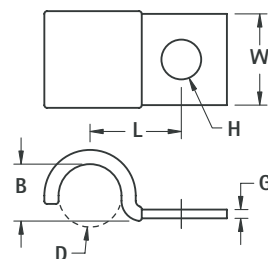

MATERIAL: Steel, Zinc Plate
Cushion: Black Vinyl

CAT. NO.	D FOR DIA.	H HOLE DIA.	L CTR TO CTR	B	G THICK	W WIDTH
8160	.187 (4.7)	.218 (5.5)	.437 (11.1)	.187 (4.7)	.032 (.81)	.500 (12.7)
8161	.250 (6.4)	.218 (5.5)	.500 (12.7)	.250 (6.4)		
8162	.312 (7.9)	.218 (5.5)	.531 (13.5)	.312 (7.9)		
8163	.375 (9.5)	.218 (5.5)	.562 (14.3)	.375 (9.5)	.048 (1.22)	.625 (15.9)
8164	.437 (11.1)	.218 (5.5)	.625 (15.9)	.437 (11.1)		
8165	.500 (12.7)	.218 (5.5)	.687 (17.4)	.500 (12.7)		
8166	.562 (14.3)	.218 (5.5)	.750 (19.1)	.562 (14.3)	.060 (1.52)	.625 (15.9)
8167	.625 (15.9)	.218 (5.5)	.812 (20.6)	.625 (15.9)		
8168	.687 (17.4)	.218 (5.5)	.812 (20.6)	.687 (17.4)		
8169	.750 (19.1)	.218 (5.5)	.875 (22.2)	.750 (19.1)	.060 (1.52)	.625 (15.9)
8170	.812 (20.6)	.281 (7.1)	.937 (23.8)	.812 (20.6)		
8171	.875 (22.2)	.281 (7.1)	.968 (24.6)	.812 (20.6)		
8172	.937 (23.8)	.281 (7.1)	1.000 (25.4)	.937 (23.8)	.060 (1.52)	.750 (19.1)
8173	1.000 (25.4)	.281 (7.1)	1.062 (27.0)	1.000 (25.4)		

CUSHIONED CABLE CLAMPS



- Ideal for securing in rugged applications
- These cushioned cable clamps secure tightly and protect against shock and vibration

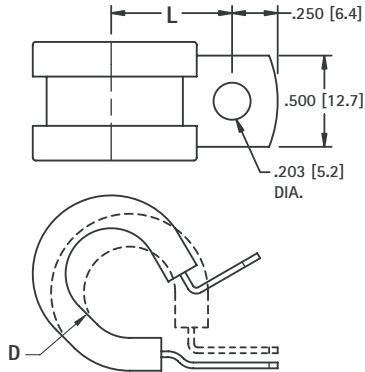

MATERIAL: .032 (0.81) Stainless Steel
Cushion: EPDM Rubber

CAT. NO.	D FOR DIA.	L CTR TO CTR
8090	.250 (6.4)	.711 (18.1)
8091	.375 (9.5)	.500 (12.7)
8092	.500 (12.7)	.562 (14.3)
8093	.625 (15.9)	.718 (18.2)
8094	.750 (19.1)	.781 (19.8)
8095	.875 (22.2)	.843 (21.4)
8096	1.000 (25.4)	.906 (23.0)

CABLE TIE ROUTING CLIP

These clips snap into PC Boards or Panel chassis and are ideal for securing cable wiring, piping, tubing, components and fibre optics when used with cable ties.

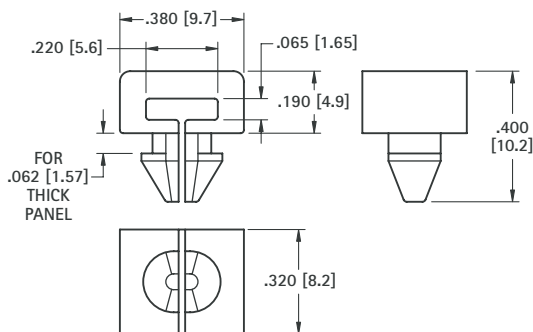

Recommended Mtg. Hole .187 (4.8) diameter.

MATERIAL: Nylon 6/6, UL Rated 94V-2

CAT. NO. 8860

NYLON CABLE CLAMPS

Ideal for securing, insulating and routing cable wiring, piping, tubing, components and fibre optics.

MATERIAL: .050 (1.27) Nylon 6/6, White

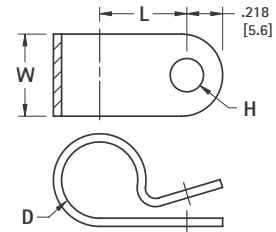

CAT. NO.	D FOR DIA.	L CTR TO CTR	W WIDTH	H HOLE
7620	.125 (3.2)	.325 (8.3)	.375 (9.5)	.140 (3.6)
7621	.125 (3.2)	.325 (8.3)	.375 (9.5)	.203 (5.2)
7622	.187 (4.7)	.380 (9.7)	.375 (9.5)	.140 (3.6)
7623	.187 (4.7)	.380 (9.7)	.375 (9.5)	.203 (5.2)
7624	.250 (6.4)	.410 (10.4)	.375 (9.5)	.140 (3.6)
7625	.250 (6.4)	.410 (10.4)	.375 (9.5)	.203 (5.2)
7626	.312 (7.9)	.445 (11.3)	.375 (9.5)	.140 (3.6)
7627	.312 (7.9)	.445 (11.3)	.375 (9.5)	.203 (5.2)
7628	.375 (9.5)	.475 (12.1)	.375 (9.5)	.140 (3.6)
7629	.375 (9.5)	.475 (12.1)	.375 (9.5)	.203 (5.2)
7630	.437 (11.1)	.525 (13.3)	.375 (9.5)	.140 (3.6)
7631	.437 (11.1)	.525 (13.3)	.375 (9.5)	.203 (5.2)
7632	.500 (12.7)	.550 (14.0)	.375 (9.5)	.140 (3.6)
7633	.500 (12.7)	.550 (14.0)	.375 (9.5)	.203 (5.2)
7634	.562 (14.3)	.625 (15.9)	.500 (12.7)	.203 (5.2)
7635	.625 (15.9)	.660 (16.8)	.500 (12.7)	.203 (5.2)
7636	.750 (19.1)	.785 (19.9)	.500 (12.7)	.203 (5.2)
7637	.875 (22.2)	.845 (21.5)	.500 (12.7)	.203 (5.2)
7638	1.000 (25.4)	.910 (23.1)	.500 (12.7)	.203 (5.2)
7639	1.125 (28.6)	.970 (24.6)	.500 (12.7)	.203 (5.2)
7640	1.250 (31.8)	1.060 (26.9)	.500 (12.7)	.203 (5.2)

NYLON CABLE TIES

Popular sizes and strengths to meet common cable tie requirements. Injection molded with one piece construction for strength and reliability. Easily installed by hand. Optional installation tool available, tightens and flush cuts cable tie.

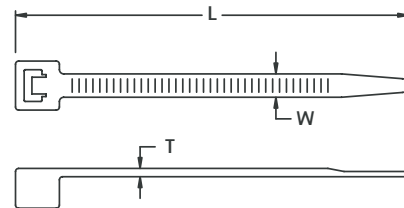

MATERIAL: Natural Nylon 6/6, UL Rated 94V-2

CAT. NO.	TENSILE STRENGTH (Min. Bundle)	FOR BUNDLE DIA. (Max.)	L LENGTH (Approx.)	W WIDTH (Approx.)	T THICKNESS (Approx.)
8865	18 lbs	1.000 (25.4)	4.250 (108.0)	.100 (2.54)	.045 (1.14)
8866	18 lbs	2.000 (50.8)	8.000 (203.2)	.100 (2.54)	.045 (1.14)
8867	40 lbs	1.250 (31.8)	6.000 (152.4)	.140 (3.56)	.050 (1.27)
8868	50 lbs	1.750 (44.5)	7.500 (190.5)	.190 (4.83)	.055 (1.40)
8869	120 lbs	4.000 (101.6)	14.500 (368.3)	.190 (4.83)	.055 (1.40)
8870	Hand Operated Cable Tie Installation Tool for 18lb to 50lb Ties				

NYLON HOLE PLUGS

Closes unused chassis holes quickly and economically. Plugs are abrasion and vibration resistant.

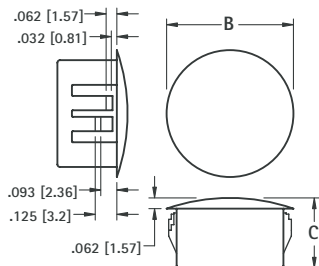
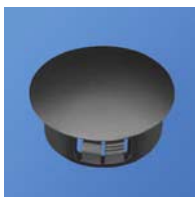

MATERIAL: Nylon 6/6, Matte Finish, Black

CAT. NO.	HOLE DIAMETER	PANEL THICKNESS	B	C
8600	.250 (6.4)	.062 (1.57)	.312 (7.9)	.312 (7.9)
8601	.312 (7.9)	.062 (1.57)	.375 (9.5)	.312 (7.9)
8602	.375 (9.5)	.125 (3.2)	.468 (11.9)	.406 (10.3)
8603	.500 (12.7)	.125 (3.2)	.578 (14.7)	.406 (10.3)
8604	.625 (15.9)	.125 (3.2)	.734 (18.6)	.406 (10.3)
8605	.750 (19.1)	.125 (3.2)	.921 (23.4)	.406 (10.3)
8606	.875 (22.2)	.125 (3.2)	1.015 (25.8)	.453 (11.5)
8607	1.000 (25.4)	.125 (3.2)	1.203 (30.6)	.453 (11.5)
8608	1.125 (28.6)	.125 (3.2)	1.218 (30.9)	.453 (11.5)
8609	1.250 (31.8)	.125 (3.2)	1.375 (34.9)	.453 (11.5)
8610	1.375 (34.9)	.125 (3.2)	1.500 (38.1)	.453 (11.5)
8611	1.500 (38.1)	.125 (3.2)	1.671 (42.4)	.453 (11.5)

STEEL HOLE PLUGS

Excellent spring retention. Plugs will cover chassis holes, wiring outlets, access holes or unused openings.

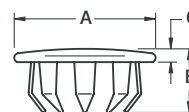

MATERIAL: Steel, Nickel Plate

CAT. NO.	HOLE DIAMETER	PANEL THICKNESS	A	B	C	PRONGS
7600	.250 (6.4)	.031-.062 (.81-1.57)	.406 (10.3)	.234 (5.9)	.062 (1.57)	6
7601	.312 (7.9)	.047-.078 (1.19-1.98)	.437 (11.1)	.250 (6.4)	.062 (1.57)	6
7602	.375 (9.5)	.047-.062 (1.19-1.57)	.500 (12.7)	.234 (5.9)	.062 (1.57)	6
7603	.500 (12.7)	.031-.062 (.81-1.57)	.656 (16.7)	.281 (7.1)	.078 (1.98)	8
7604	.625 (15.9)	.062-.093 (1.57-2.36)	.812 (20.6)	.296 (7.5)	.078 (1.98)	8
7605	.750 (19.1)	.062-.093 (1.5-2.36)	.921 (23.4)	.296 (7.5)	.078 (1.98)	12
7606	.875 (22.2)	.062-.093 (1.57-2.36)	1.062 (27.0)	.296 (7.5)	.062 (1.57)	12
7607	1.000 (25.4)	.062-.156 (1.57-3.9)	1.140 (29.0)	.328 (8.3)	.093 (2.36)	12
7608	1.125 (28.6)	.031-.125 (.79-3.2)	1.312 (33.3)	.343 (8.7)	.093 (2.36)	12
7609	1.250 (31.8)	.062-.093 (1.57-2.36)	1.437 (36.5)	.343 (8.7)	.093 (2.36)	12
7610	1.375 (34.9)	.031-.125 (.79-3.2)	1.562 (39.7)	.406 (10.3)	.078 (1.98)	12
7611	1.500 (38.1)	.031-.062 (.79-1.57)	1.640 (41.7)	.406 (10.3)	.093 (2.36)	12

NYLON VENT PLUGS

Used to cover chassis holes while allowing air flow for ventilation.

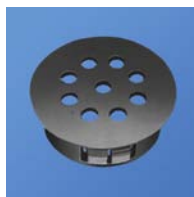

- Snaps into .032 (.81) to .125 (3.2) thick panels.

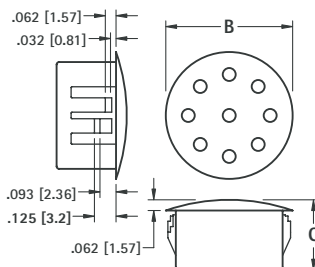

MATERIAL: Nylon 6/6, Matte Finish, Black

CAT. NO.	HOLE DIAMETER	B	C
8612	.875 (22.2)	1.015 (25.8)	.453 (11.5)
8613	1.000 (25.4)	1.218 (30.9)	.453 (11.5)

NYLON SPLIT BUSHINGS

Designed to be assembled into holes that already contain wire or cable. Versatile bushing can be used on all chassis from .032 (.81) to .125 (3.2).

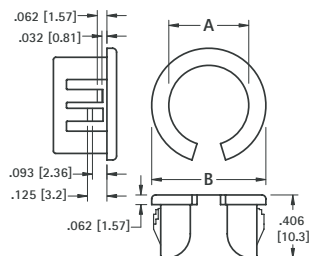

MATERIAL: Nylon 6/6, Black

CAT. NO.	HOLE SIZE REQUIRED	A INSIDE DIAMETER	B HEAD DIAMETER
8490	.375 (9.5)	.265 (6.7)	.421 (10.7)
8491	.500 (12.7)	.312 (7.9)	.562 (14.3)
8492	.562 (14.3)	.390 (9.9)	.640 (16.3)
8493	.625 (15.9)	.453 (11.5)	.687 (17.4)
8494	.750 (19.1)	.546 (13.9)	.796 (20.2)
8495	.875 (22.2)	.671 (17.0)	.921 (23.4)
8496	1.000 (25.4)	.796 (20.2)	1.062 (27.0)

NYLON INSULATING BUSHINGS

Snaps into panel hole to provide protection for wire, cable and tubing from sharp uneven edges.

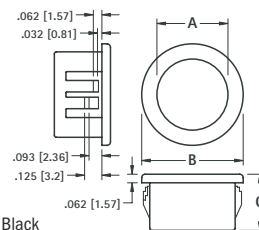
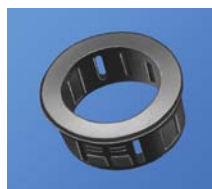

MATERIAL: Nylon 6/6, Black

CAT. NO.	HOLE SIZE REQUIRED	MAXIMUM CHASSIS THICKNESS	A INSIDE DIAMETER	B HEAD DIAMETER	C OVERALL HEIGHT
8470	.250 (6.4)	.062 (1.57)	.125 (3.2)	.312 (7.9)	.312 (7.9)
8471	.312 (7.9)	.062 (1.57)	.187 (4.7)	.375 (9.5)	.312 (7.9)
8472	.375 (9.5)	.125 (3.2)	.250 (6.4)	.468 (11.9)	.406 (10.3)
8473	.437 (11.1)	.125 (3.2)	.312 (7.9)	.531 (13.5)	.406 (10.3)
8474	.500 (12.7)	.125 (3.2)	.375 (9.5)	.578 (14.7)	.406 (10.3)
8475	.562 (14.3)	.125 (3.2)	.437 (11.1)	.656 (16.7)	.406 (10.3)
8476	.625 (15.9)	.125 (3.2)	.500 (12.7)	.718 (18.2)	.406 (10.3)
8477	.750 (19.1)	.125 (3.2)	.562 (14.3)	.843 (21.4)	.406 (10.3)
8478	.875 (22.2)	.125 (3.2)	.625 (15.9)	.953 (24.2)	.453 (11.5)
8479	1.000 (25.4)	.125 (3.2)	.750 (19.1)	1.125 (28.6)	.453 (11.5)
8480	1.187 (30.1)	.125 (3.2)	.937 (23.8)	1.312 (33.3)	.453 (11.5)
8481	1.250 (31.8)	.125 (3.2)	.937 (23.8)	1.359 (34.5)	.453 (11.5)
8482	1.375 (34.9)	.125 (3.2)	1.000 (25.4)	1.468 (37.3)	.453 (11.5)
8483	1.500 (38.1)	.125 (3.2)	1.062 (27.0)	1.609 (40.9)	.453 (11.5)
8484	1.750 (44.5)	.125 (3.2)	1.375 (34.9)	1.875 (47.6)	.453 (11.5)
8485	2.000 (50.8)	.125 (3.2)	1.625 (41.3)	2.125 (54.0)	.453 (11.5)
8486	2.500 (63.5)	.250 (6.4)	1.968 (50.0)	2.656 (67.5)	.718 (18.2)

ANTI-VIBRATION GROMMETS

Anti-vibration grommets are designed for noise suppression in office or lab equipment. Additionally, they isolate sensitive instrumentation from unpredictable vibration and shock. The fingers of the grommets provide the flex needed to dampen unwanted noise and vibration. Specially designed shoulder screws are designed to provide the correct spacing.

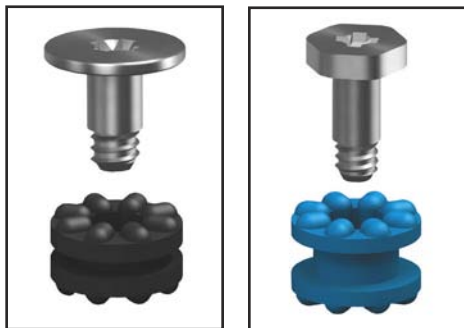

ROUND HEAD

HEX HEAD

Screw supplied unassembled with isolator

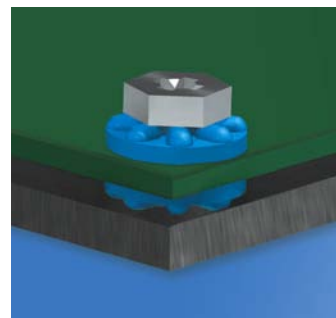
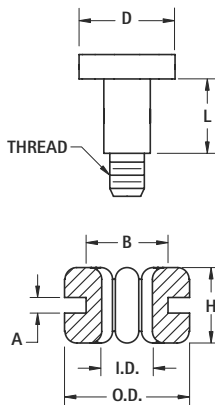

MATERIAL:

Isolator: EPDM Rubber

Shoulder Screw: Steel, Nickel Plate

BLACK CAT. NO.	BLUE CAT. NO.	O.D. OUTSIDE DIAMETER	I.D. INSIDE DIAMETER	H HEIGHT	A PANEL THICK	B MTG. HOLE	SHOULDER SCREW			
							LENGTH (L)	THREAD	D	HEAD
765	766	.379 (9.6)	.154 (3.9)	.228 (5.8)	.063 (1.6)	.250 (6.4)	.189 (4.8)	6-32	.250 (6.4)	Hex
769	770	.377 (9.6)	.161 (4.1)	.298 (7.6)	.125 (3.2)	.250 (6.4)	.252 (6.4)	6-32	.300 (7.6)	
775	776	.551 (14.0)	.191 (4.9)	.319 (8.1)	.063 (1.6)	.375 (9.5)	.318 (8.0)	6-32	.394 (10.0)	Round
767	768	.379 (9.6)	.154 (3.9)	.228 (5.8)	.047 (1.2)	.250 (6.4)	.197 (5.0)	M3	.394 (10.0)	
771	772	.411 (11.2)	.181 (4.6)	.209 (5.3)	.031 (0.8)	.315 (8.0)	.197 (5.0)	M3	.394 (10.0)	
773	774	.551 (14.0)	.191 (4.9)	.291 (7.4)	.047 (1.2)	.375 (9.5)	.252 (6.4)	M3	.394 (10.0)	

RUBBER GROMMETS

Ideal for electrical insulation and mechanical damping.

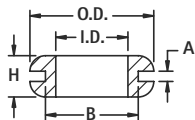
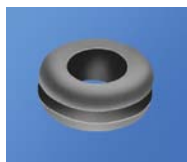

MATERIAL: Rubber, BUNA N

CAT. NO.	I.D. INSIDE DIAMETER	B MTG. HOLE	A PANEL THICKNESS	O.D. OUTSIDE DIAMETER	H HEIGHT
730	.125 (3.2)	.187 (4.7)	.062 (1.57)	.312 (7.9)	.187 (4.7)
733	.125 (3.2)	.250 (6.4)	.062 (1.57)	.343 (8.7)	.187 (4.7)
734	.125 (3.2)	.437 (11.1)	.062 (1.57)	.625 (15.9)	.187 (4.7)
735	.125 (3.2)	.375 (9.5)	.093 (2.36)	.500 (12.7)	.312 (7.9)
736	.187 (4.7)	.312 (7.9)	.062 (1.57)	.437 (11.1)	.218 (5.5)
737	.187 (4.7)	.281 (7.2)	.093 (2.36)	.437 (11.1)	.218 (5.5)
738	.250 (6.4)	.437 (11.1)	.062 (1.57)	.625 (15.9)	.187 (4.7)
739	.250 (6.4)	.375 (9.5)	.062 (1.57)	.562 (14.3)	.250 (6.4)
740	.250 (6.4)	.375 (9.5)	.093 (2.36)	.500 (12.7)	.250 (6.4)
741	.312 (7.9)	.562 (14.3)	.062 (1.57)	.812 (20.6)	.312 (7.9)
742	.312 (7.9)	.437 (11.1)	.062 (1.57)	.625 (15.9)	.281 (7.1)
743	.312 (7.9)	.437 (11.1)	.093 (2.36)	.625 (15.9)	.312 (7.9)
744	.375 (9.5)	.625 (15.9)	.062 (1.57)	.875 (22.2)	.312 (7.9)
745	.375 (9.5)	.500 (12.7)	.062 (1.57)	.625 (15.9)	.250 (6.4)
732	.437 (11.1)	.562 (14.3)	.062 (1.57)	.750 (19.1)	.250 (6.4)
746	.437 (11.1)	.687 (17.4)	.062 (1.57)	.937 (23.8)	.312 (7.9)
747	.500 (12.7)	.812 (20.6)	.062 (1.57)	1.062 (27.0)	.312 (7.9)
748	.500 (12.7)	1.250 (31.8)	.062 (1.57)	1.500 (38.1)	.250 (6.4)
749	.500 (12.7)	.750 (19.1)	.093 (2.36)	.968 (24.6)	.281 (7.1)
750	.562 (14.3)	.812 (20.6)	.062 (1.57)	1.062 (27.0)	.312 (7.9)
752	.625 (15.9)	.875 (22.2)	.062 (1.57)	1.125 (28.6)	.312 (7.9)
753	.625 (15.9)	1.250 (31.8)	.062 (1.57)	1.500 (38.1)	.250 (6.4)
755	.750 (19.1)	1.062 (27.0)	.062 (1.57)	1.375 (34.9)	.375 (9.5)
756	.750 (19.1)	1.437 (36.5)	.062 (1.57)	1.812 (46.0)	.375 (9.5)
757	.875 (22.2)	1.250 (31.8)	.062 (1.57)	1.625 (41.3)	.437 (11.1)

FLEXIBLE GROMMETING

Ideal for maintenance, short-run production, R&D or prototyping. Supplied in 25 ft. rolls. Make your own grommets to fit any size or shape required.

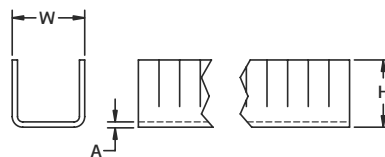

MATERIAL: Nylon 6/6, Black

CAT. NO.	MAX PANEL THICK	W WIDTH	H HEIGHT	A THICK
8615	.052 (1.32)	.139 (3.5)	.190 (4.8)	.028 (0.7)
8616	.085 (2.16)	.182 (4.6)	.200 (5.1)	.040 (1.02)
8617	.125 (3.18)	.232 (5.9)	.220 (5.6)	.040 (1.02)

"UNIVERSAL" RUBBER GROMMET

- Designed to adjust to different cable diameters from .125 (3.2) to .312 (7.9).
- Self-adjusting membrane forms a dust resistant seal.

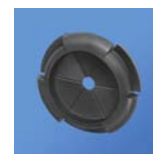
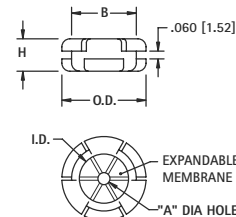

MATERIAL: Thermoplastic Rubber, Black

CAT. NO.	O.D. OUTSIDE	I.D. INSIDE DIA.	A DIA. HOLE	B MTG HOLE	H HEIGHT
777	.650 (16.32)	.380 (9.7)	.090 (2.3)	.500 (12.7)	.250 (6.4)
778	1.25 (31.8)	.810 (20.6)	.160 (4.0)	1.000 (25.4)	.370 (9.4)

ADHESIVE BUMPERS

Applies quickly and easily. Prevents nicks, scratches, scuffs, vibration, slippage and noise. Easy peel and stick mounting. Crack resistant. High coefficient of friction. Sold in sheets.

FLAT

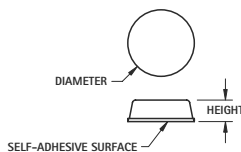

MATERIAL: Molded Polyurethane

BLACK CAT. NO.	CLEAR CAT. NO.	DIAMETER	HEIGHT	PARTS/SHEET
780-B	780-C	.375 (9.5)	.125 (3.2)	300
781-B	781-C	.500 (12.7)	.060 (1.5)	200
782-B	782-C	.500 (12.7)	.140 (3.6)	200

DOMED

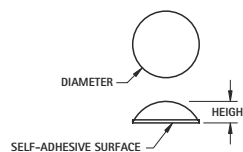

MATERIAL: Molded Polyurethane

BLACK CAT. NO.	CLEAR CAT. NO.	DIAMETER	HEIGHT	PARTS/SHEET
783-B	783-C	.250 (6.4)	.062 (1.6)	578
784-B	784-C	.335 (8.5)	.085 (2.2)	450
785-B	785-C	.440 (11.2)	.200 (5.1)	242

RECESSED BUMPERS

Provides excellent traction and shock absorbing qualities. available with or without Mold-in Washers.



FIG. 1

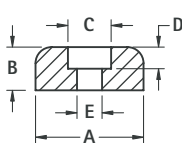

FIG. 2 Mold-In Washer

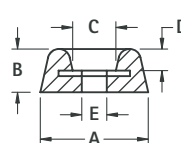
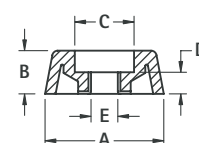

FIG. 3 Mold-In Washer



MATERIAL: Rubber, BUNA S (Figs. 1 & 2), EPDN

MATERIAL: Rubber, BUNA S (Figs. 1 & 2), EPDN

MATERIAL: EPDN Rubber

CAT. NO.	FIG.	A	B	C	D	E	SCREW SIZE
720	1	.500 (12.7)	.250 (6.4)	.250 (6.4)	.187 (4.7)	.125 (3.2)	# 4
721	1	.625 (15.9)	.312 (7.9)	.250 (6.4)	.187 (4.7)	.125 (3.2)	# 4
722	1	.718 (18.2)	.437 (11.1)	.250 (6.4)	.218 (5.5)	.125 (3.2)	# 4
723	2	.937 (23.8)	.375 (9.5)	.375 (9.5)	.218 (5.5)	.187 (4.7)	# 8
724*	3	.687 (17.4)	.250 (6.4)	.343 (8.7)	.125 (3.2)	.155 (3.9)	# 6
725*	3	.875 (22.2)	.312 (7.9)	.406 (10.3)	.187 (4.7)	.187 (4.7)	# 8
726*	3	1.062 (27.0)	.437 (11.1)	.468 (11.9)	.234 (5.9)	.200 (5.1)	# 10
727	3	.562 (14.3)	.375 (9.5)	.218 (5.5)	.187 (4.7)	.115 (2.9)	# 4
728	3	.750 (19.1)	.437 (11.1)	.265 (6.7)	.250 (6.4)	.148 (3.8)	# 6
729	3	.937 (23.8)	.625 (15.9)	.359 (9.1)	.328 (8.3)	.174 (4.4)	# 8

SELF-LOCKING BUMPER FOOT



- A unique easy-to-install self-locking bumper foot
- Two piece assembly, furnished pre-assembled
- Vibration absorbing and skid resistant
- Mounts without screws or tools

Recommended Mounting Hole: .305 (7.8) diameter

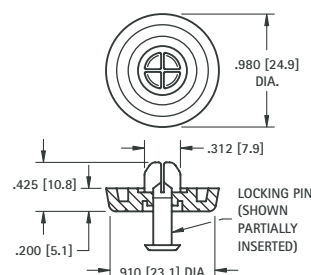

MATERIAL:

Foot: Santoprene, Black **Pin:** Polypropylene, Black

CAT. NO. 717

FLAT WASHERS - NYLON & FIBRE

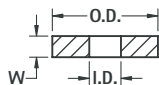

MATERIAL:

Fibre: Commercial Grade per ASTM D710 Nylon: Grade 6/6 per ASTM D4066

MATERIAL	I.D.	O.D.	W THICKNESS		
			.032 (.81)	.047 (1.19)	.062 (1.57)
			CAT. NO.	CAT. NO.	CAT. NO.
FIBRE	.098 (2.49) #2	.187 (4.8)	3111	3148	3366
		.250 (6.4)	3112	3149	3367
		.312 (7.9)	3113	3150	3194
NYLON	.098 (2.49) #2	.187 (4.8)	3114	3151	3356
		.250 (6.4)	3347*	3152	3357*
		.312 (7.9)	3115	3153	3195
FIBRE	.120 (3.05) #4	.250 (6.4)	3116	3154	3368
		.312 (7.9)	348	3155	3196
		.375 (9.5)	3117	3156	3197
NYLON	.120 (3.05) #4	.250 (6.4)	3348	345	3358
		.312 (7.9)	3359	3157	3198
		.375 (9.5)	3118	3158	3200
FIBRE	.140 (3.56) #6	.250 (6.4)	3119	3159	3369
		.312 (7.9)	3120	3160	3370
		.375 (9.5)	3121	3161	3201
NYLON	.140 (3.56) #6	.250 (6.4)	3122	3162	3360
		.312 (7.9)	3349	346	3361
		.375 (9.5)	3123	3163	3202
FIBRE	.171 (4.34) #8	.312 (7.9)	3124	3164	3203
		.375 (9.5)	3125	3165	3372
		.437 (11.1)	3126	3166	3204
NYLON	.171 (4.34) #8	.312 (7.9)	3127	3167	3205
		.375 (9.5)	3350	3168	3363
		.437 (11.1)	3128	3169	3206
FIBRE	.196 (4.98) #10	.312 (7.9)	349	3170	3207
		.375 (9.5)	3129	3171	3208
		.437 (11.1)	3130	3172	3209
NYLON	.196 (4.98) #10	.500 (12.7)	3131	3173	3210
		.312 (7.9)	3364	3174	3211
		.375 (9.5)	3352	3175	3212
FIBRE	.260 (6.60) 1/4"	.437 (11.1)	3132	3176	3213
		.500 (12.7)	3133	3177	3214
		.750 (19.1)	3134	3178	3215
NYLON	.260 (6.60) 1/4"	.500 (12.7)	3135	3179	3373
		.625 (15.9)	3136	3180	3216
		.750 (19.1)	3137	3181	3217
FIBRE	.385 (9.65) 3/8"	.437 (11.1)	3138	3182	3218
		.500 (12.7)	3353	3183	3365
		.625 (15.9)	3139	3184	3219
NYLON	.385 (9.65) 3/8"	.750 (19.1)	3140	3185	3220
		1.000 (25.4)	3141	3186	3221
		.500 (12.7)	3142	3187	3222
FIBRE	.500 (12.7) 1/2"	.625 (15.9)	3143	3188	3223
		.750 (19.1)	3144	3189	3224
		1.000 (25.4)	3145	3190	3225
NYLON	.500 (12.7) 1/2"	.625 (15.9)	3354	3191	3226
		.750 (19.1)	3146	3192	3227
		1.000 (25.4)	3147	3193	3228

*.090 (2.3) I.D.

NYLON RETAINING WASHERS

Retaining Washers are similar to our standard washers, but with a specially configured ID designed to grip the screw shank. The washer remains attached to the screw, for quick, easy assembly.

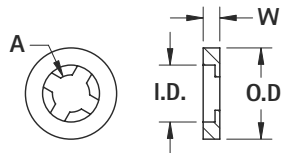
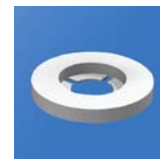

MATERIAL:

Nylon, 6/6 UL Rated 94V-0

HEIGHT (H)		SCREW SIZE	A	I.D.	O.D.
.032 (0.81)	.062 (1.57)				
CAT. NO.	CAT. NO.				
2244	2284	#2 (M2)	.115 (2.9)	.078 (1.9)	.203 (5.2)
2245	2285	#4	.156 (3.9)	.102 (2.6)	.256 (6.7)
2246	2286	#6 (M3.5)	.198 (5.0)	.128 (3.3)	.328 (8.3)
2247	2287	#8 (M4)	.235 (5.9)	.152 (3.8)	.390 (9.9)
2248	—			.135 (3.4)	.390 (9.9)
2249	—	#10	.227 (7.0)	.177 (4.5)	.453 (11.5)
—	2290				.500 (12.7)
—	2291				.630 (16.0)
2252	2292	#1/4 (M6)	.375 (9.5)	.234 (5.9)	.593 (15.1)
2253	2293	#3/8	.564 (14.3)	.350 (8.9)	.890 (22.6)

STEEL FLAT WASHERS

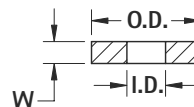
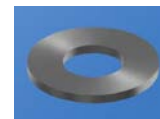

MATERIAL: Steel, Zinc Plate

CAT. NO.	I.D.	O.D.	W	SCREW SIZE
4692	.128 (3.3)	.281 (7.1)	.025 (.63)	#4 (M3)
7235-1	.120 (3.1)	.220 (5.6)	.032 (.81)	#4 (M3)
4699	.147 (3.7)	.373 (9.5)	.031 (.80)	#6 (M3.5)
4703	.200 (5.1)	.436 (11.1)	.033 (.84)	#10 (M4)
1719-1	.391 (9.9)	1.500 (38.1)	.094 (2.4)	3/8"

INTERNAL TOOTH WASHERS

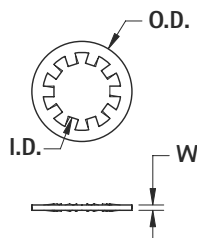

MATERIAL: Phospor Bronze - Nickel Plate

CAT. NO.	I.D.	O.D.	W	SCREW SIZE
11362-5	.226 (5.7)	.402 (10.2)	.020 (.51)	#12 (M5)
4691	.261 (6.6)	.469 (11.9)	.025 (.63)	1/4" (M6)

STEEL LOCK WASHERS

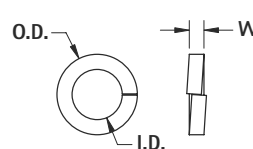

MATERIAL: Steel, Zinc Plate

CAT. NO.	I.D.	O.D.	W	SCREW SIZE
4693	.177 (3.0)	.205 (5.2)	.031 (.78)	#4 (M3)
7235-2	.177 (3.0)	.197 (5.0)	.025 (.63)	#4 (M3)
4700	.144 (3.7)	.250 (6.4)	.033 (.84)	#6 (M3.5)
1477	.195 (5.0)	.320 (8.1)	.047 (1.2)	#10 (M4)
1476	.256 (6.5)	.479 (12.2)	.074 (1.9)	1/4" (M6)
1485	.321 (8.2)	.586 (14.8)	.078 (2.0)	5/16" (M8)

FIBRE SHOULDER WASHERS

MATERIAL: Fibre, Commercial Grade per ASTM D710

CAT. NO.	L	O.D.	B	I.D.	S.D.	SCREW SIZE
3229	.025 (.64)	.250 (6.4)	.047 (1.2)	.093 (2.4)	.123 (3.1)	#2
3061	.025 (.64)	.250 (6.4)	.047 (1.2)	.093 (2.4)	.156 (4.0)	
344	.015 (.38)	.312 (7.9)	.062 (1.57)	.125 (3.2)	.203 (5.2)	
343	.025 (.64)	.312 (7.9)	.062 (1.57)	.125 (3.2)	.203 (5.2)	#4
3062	.031 (.79)	.250 (6.4)	.031 (.79)	.115 (2.9)	.187 (4.7)	
3230	.031 (.79)	.281 (7.1)	.062 (1.57)	.115 (2.9)	.175 (4.4)	
3231	.031 (.79)	.312 (7.9)	.062 (1.57)	.120 (3.1)	.180 (4.6)	#6
4698	.031 (.79)	.250 (6.4)	.062 (1.57)	.140 (3.6)	.187 (4.7)	
3064	.031 (.79)	.312 (7.9)	.062 (1.57)	.140 (3.6)	.187 (4.7)	
3232	.031 (.79)	.375 (9.5)	.062 (1.57)	.140 (3.6)	.210 (5.3)	
3233	.031 (.79)	.375 (9.5)	.062 (1.57)	.140 (3.6)	.240 (6.1)	
3234	.031 (.79)	.500 (12.7)	.062 (1.57)	.140 (3.6)	.240 (6.1)	#8
3065	.031 (.79)	.375 (9.5)	.062 (1.57)	.170 (4.3)	.246 (6.2)	
3066	.031 (.79)	.417 (10.6)	.062 (1.57)	.170 (4.3)	.210 (5.3)	
3235	.031 (.79)	.312 (7.9)	.062 (1.57)	.170 (4.3)	.218 (5.5)	
3236	.031 (.79)	.375 (9.5)	.062 (1.57)	.170 (4.3)	.215 (5.5)	
3237	.031 (.79)	.500 (12.7)	.062 (1.57)	.170 (4.3)	.240 (6.1)	#10
4702	.031 (.79)	.375 (9.5)	.062 (1.57)	.194 (4.9)	.308 (7.8)	
3238	.031 (.79)	.375 (9.5)	.062 (1.57)	.194 (4.9)	.240 (6.1)	
3239	.031 (.79)	.500 (12.7)	.062 (1.57)	.196 (5.0)	.240 (6.1)	.250-20
4711	.031 (.79)	.500 (12.7)	.062 (1.57)	.253 (6.4)	.308 (7.8)	
3240	.031 (.79)	.625 (15.9)	.062 (1.57)	.265 (6.7)	.359 (9.1)	
3069	.031 (.79)	.625 (15.9)	.062 (1.57)	.385 (9.8)	.498 (12.6)	.375-24
3241	.031 (.79)	.750 (19.1)	.062 (1.57)	.385 (9.8)	.498 (12.6)	

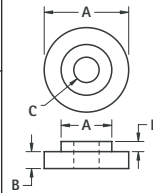
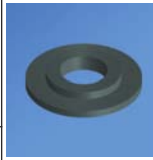

NYLON SHOULDER WASHER/BUSHINGS

MATERIAL: Nylon 6/6 per ASTM D4066

CAT. NO.	L	O.D.	B	I.D.	S.D.	SCREW SIZE
7680	.025 (.64)	.260 (6.6)	.030 (.76)	.095 (2.4)	.154 (3.9)	#2
3051	.125 (3.2)	.181 (4.6)	.047 (1.2)	.090 (2.3)	.120 (3.1)	
3101	.187 (4.8)	.181 (4.6)	.047 (1.2)	.090 (2.3)	.120 (3.1)	
3052	.250 (6.4)	.181 (4.6)	.047 (1.2)	.090 (2.3)	.120 (3.1)	#4
3049*	.031 (.79)	.218 (5.5)	.040 (1.0)	.115 (2.9)	.135 (3.4)	
7681	.047 (1.2)	.250 (6.4)	.032 (.81)	.115 (2.9)	.185 (4.7)	
3053	.093 (2.4)	.235 (6.0)	.047 (1.2)	.115 (2.9)	.145 (3.7)	
3102	.125 (3.2)	.235 (6.0)	.047 (1.2)	.115 (2.9)	.145 (3.7)	#6
3103	.187 (4.7)	.235 (6.0)	.047 (1.2)	.115 (2.9)	.145 (3.7)	
340	.250 (6.4)	.235 (6.0)	.047 (1.2)	.115 (2.9)	.145 (3.7)	
7682	.032 (.81)	.385 (9.8)	.062 (1.57)	.145 (3.7)	.240 (6.1)	#8
7683	.032 (.81)	.250 (6.4)	.062 (1.57)	.140 (3.6)	.187 (4.7)	
7684	.032 (.81)	.312 (7.9)	.062 (1.57)	.140 (3.6)	.187 (4.7)	
3054	.125 (3.2)	.290 (7.4)	.047 (1.19)	.140 (3.6)	.170 (4.3)	#10
3104	.187 (4.7)	.290 (7.4)	.047 (1.19)	.140 (3.6)	.170 (4.3)	
341	.250 (6.4)	.290 (7.4)	.047 (1.19)	.140 (3.6)	.170 (4.3)	
3055	.500 (12.7)	.290 (7.4)	.047 (1.19)	.140 (3.6)	.170 (4.3)	.250-20
7685	.032 (.81)	.375 (9.5)	.032 (.81)	.171 (4.3)	.250 (6.4)	
3056	.140 (3.6)	.344 (8.7)	.062 (1.57)	.171 (4.3)	.205 (5.2)	
3105	.250 (6.4)	.344 (8.7)	.062 (1.57)	.171 (4.3)	.205 (5.2)	#10
342	.375 (9.5)	.344 (8.7)	.062 (1.57)	.171 (4.3)	.205 (5.2)	
3106	.500 (12.7)	.344 (8.7)	.062 (1.57)	.171 (4.3)	.205 (5.2)	
7686	.032 (.81)	.375 (9.5)	.062 (1.57)	.196 (5.0)	.308 (7.8)	#10
3107	.093 (2.36)	.438 (11.1)	.062 (1.57)	.200 (5.1)	.260 (6.6)	
3108	.250 (6.4)	.399 (10.1)	.062 (1.57)	.200 (5.1)	.260 (6.6)	
3057	.500 (12.7)	.399 (10.1)	.062 (1.57)	.200 (5.1)	.260 (6.6)	.250-20
3058	.750 (19.1)	.399 (10.1)	.062 (1.57)	.200 (5.1)	.260 (6.6)	
7687	.032 (.81)	.437 (11.1)	.032 (.81)	.253 (6.4)	.310 (7.9)	
7688	.078 (1.98)	.492 (12.7)	.032 (.81)	.260 (6.7)	.312 (7.9)	#10
3059	.187 (4.7)	.513 (13.0)	.062 (1.57)	.260 (6.7)	.312 (7.9)	
3109	.250 (6.4)	.513 (13.0)	.062 (1.57)	.260 (6.7)	.312 (7.9)	
3110	.375 (9.5)	.513 (13.0)	.062 (1.57)	.260 (6.7)	.312 (7.9)	.250-20
3060	.500 (12.7)	.513 (13.0)	.062 (1.57)	.260 (6.7)	.312 (7.9)	

* Black

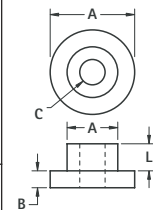

HEX MACHINE NUTS

MATERIAL: Nylon 6/6 (RoHS Compliant)
Steel, Zinc Plate (Non-RoHS Compliant)
Note: RoHS Compliant finishes available on special order

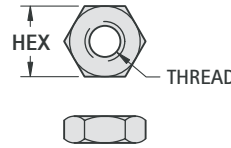
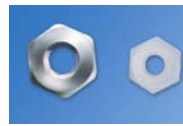

STEEL CAT. NO.	NYLON CAT. NO.	HEX	THREAD
4694	—	187 (4.7)	4-40
9600	9605	.250 (6.4)	6-32
4701	—	.250 (6.4)	6-32
9602	9606	.312 (7.9)	8-32
9603	—	.250 (6.4)	8-32
9604	9607	.312 (7.9)	10-32
4705	9608	.375 (9.5)	.250-28
4713	—	.430 (10.9)	.250-28
4716	—	.500 (12.7)	.312-24

METRIC MACHINE NUTS

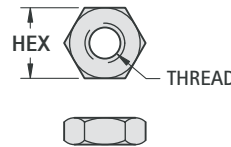

MATERIAL: Nylon 6/6 UL Rated 94V-2
Steel, Nickel Plate

STEEL CAT. NO.	NYLON CAT. NO.	HEX	THREAD
4707	4687	5.00 mm	M2.5
4708	4688	5.50 mm	M3
4709	4689	7.00 mm	M4

BLIND CAPTIVE NUTS - PRESS FIT

MOUNT CHASSIS, PANELS, HEAT SINKS, SOCKETS

- Easy Assembly • Dampens Vibration
- Eliminates Insulating Washer • Hi-Dielectric Strength

A unique reusable fastener made of NYLON which contains a threaded brass nut. Finger pressure or light tap seals it in a pre-drilled hole. The nut is drawn up causing a Nylon bulge behind the workpiece. Screw may be removed or replaced.

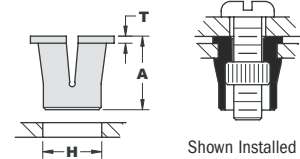

Shown Installed
(Screw not supplied)

MATERIAL: Molded Nylon with Brass threaded insert

CAT. NO.	THREAD	H HOLE SIZE REQ'D.	IDEAL SHEET THICKNESS	A	T
4341	4-40	.250 (6.4)	.047 (1.2)	.312 (7.9)	.030 (.76)
4342	6-32	.312 (7.9)	.078 (1.9)	.375 (9.5)	.030 (.76)
4343	8-32	.406 (10.3)	.093 (2.4)	.500 (12.7)	.030 (.76)

MACHINE SCREWS

Suited for a variety of fastening applications to assure firm, electrical and mechanical connections. Flat Head styles for use where fasteners cannot protrude above mating surfaces. Pan Head style to replace round head type for cosmetic enhancement and smooth surface area uses.

For Metric Hardware Refer to page 55.

MATERIAL: Steel, Zinc Plate (Non-RoHS Compliant)

Note: RoHS Compliant finishes available on special order

Nylon 6/6 (RoHS Compliant)

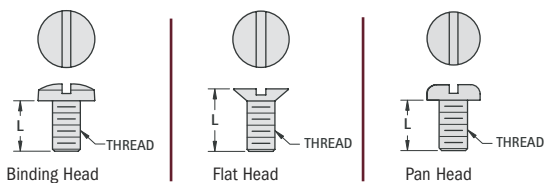

THREAD	LENGTH	BINDING HEAD		FLAT HEAD		PAN HEAD	
		STEEL CAT. NO.	NYLON CAT. NO.	STEEL CAT. NO.	NYLON CAT. NO.	STEEL CAT. NO.	NYLON CAT. NO.
2-56	.250 (6.4)	9455	—	9555	—	9355	—
	.500 (12.7)	9456	—	9556	—	9356	—
	.750 (19.1)	9457	—	9557	—	9357	—
4-40	.250 (6.4)	9400	9427	9500	9527	9300	9327
	.375 (9.5)	9401	9428	9501	9528	9301	9328
	.500 (12.7)	9402	9429	9502	9529	9302	9329
	.625 (15.9)	9403	9430	9503	9530	9303	9330
	.750 (19.1)	9404	9431	9504	9531	9304	9331
	1.000 (25.4)	9405	9432	9505	9532	9305	9332
6-32	.187 (4.7)	9406	9433	9506	9533	9306	9333
	.250 (6.4)	9407	9434	9507	9534	9307	9334
	.375 (9.5)	9408	9435	9508	9535	9308	9335
	.500 (12.7)	9409	9436	9509	9536	9309	9336
	.625 (15.9)	9410	9437	9510	9537	9310	9337
	.750 (19.1)	9411	9438	9511	9538	9311	9338
	1.000 (25.4)	9412	9439	9512	9539	9312	9339
	1.250 (31.8)	9413	9440	9513	9540	9313	9340
2.000 (50.8)	9414	9441	9514	9541	9314	9341	
8-32	.250 (6.4)	9416	9443	9516	9543	9316	9343
	.375 (9.5)	9417	9444	9517	9544	9317	9344
	.500 (12.7)	9418	9445	9518	9545	9318	9345
	.625 (15.9)	9419	9446	9519	9546	9319	9346
	.750 (19.1)	9420	9447	9520	9547	9320	9347
	1.000 (25.4)	9421	9448	9521	9548	9321	9348
1.250 (31.8)	9422	9449	9522	9549	9322	9349	
10-32	.500 (12.7)	9423	9450	9523	9550	9323	9350
	.750 (19.1)	9424	9451	9524	9551	9324	9351
	1.000 (25.4)	9425	9452	9525	9552	9325	9352
	1.500 (38.1)	9426	9453	9526	9553	9326	9353

SELF TAPPING SCREWS



- Slotted drive, hex head

Highly versatile screw, used in wood, fiberglass and metal where machine thread inserts are not furnished.

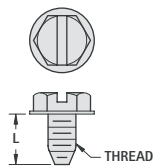

THREAD	LENGTH	CAT. NO.
No. 4	.375 (9.5)	9575
No. 6	.375 (9.5)	9576
	.500 (12.7)	9577
No. 8	.375 (9.5)	9578
	.500 (12.7)	9579
No. 10	.375 (9.5)	9580
	.500 (12.7)	9581

MATERIAL: Steel, Zinc Plate (Non-RoHS Compliant)

Note: RoHS Compliant finishes available on special order

BINDING HEAD SCREWS - COLORED HEAD

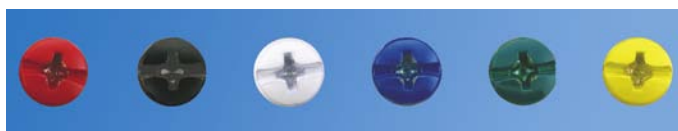

Ideal for quick identification of screw terminal. Reduces errors in wiring of cables. See pages 62-65 for screw terminals with colored screws installed. Only head is painted, provides reliable electrical contact to terminal.

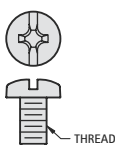

CAT. NO.	HEAD COLOR	CAT. NO.
M3 x 6mm L		6-32 x 250 (6.3) L
7689-1	NICKEL	8190-1
9191-2	RED	9190-2
9191-3	BLACK	9190-3
9191-4	WHITE	9190-4
9191-5	BLUE	9190-5
9191-6	GREEN	9190-6
9191-7	YELLOW	9190-7

MATERIAL: Brass, Nickel Plate with Painted Color Head

METRIC SCREWS

Choice of: Steel, Zinc Plate • Nylon: 6/6, UL Rated 94V-2

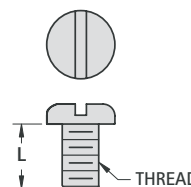

STEEL CAT. NO.	L	NYLON 6/6 CAT. NO.
M2.5 THREAD		
29301	6.00	29331
29304	12.00	29334
29306	16.00	29336
M3 THREAD		
29311	6.00	29341
29314	12.00	29344
29316	16.00	29346
29318	25.00	29348
M4 THREAD		
29321	6.00	29351
29324	12.00	29354
29326	16.00	29356
29328	25.00	29358

STAINLESS STEEL PAN HEAD SCREWS

- Phillips drive pan head machine screws



MATERIAL: Stainless Steel

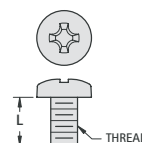

CAT. NO.	L LENGTH	THREAD
9900	.250 (6.4)	4-40
9901	.375 (9.5)	
9902	.500 (12.7)	
9903	.250 (6.4)	6-32
9904	.375 (9.5)	
9905	.500 (12.7)	
9906	.375 (9.5)	8-32
9907	.500 (12.7)	
9908	.750 (19.1)	
9909	.375 (9.5)	10-32
9910	.500 (12.7)	
9911	.750 (19.1)	

WIDE ROLL EYELETS

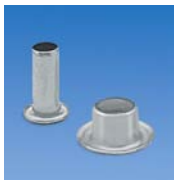

A choice of the most popular sizes in use for PC board and electronic assembly applications.

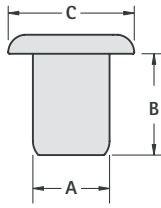

MATERIAL: Brass, Bright Electro Tin, MIL-T-10727. Other platings can be furnished.

CAT. NO.	A OUTSIDE DIAMETER BARREL	B LENGTH UNDER FLANGE	C FLANGE DIAMETER	MTG. HOLE SIZE	STAKING TOOL CAT. NO.
22		.062 (1.57)			
23		.093 (2.36)			
24	.059 (1.49) O.D.	.125 (3.18)	.105 (2.7)	.062 (1.57) USE DRILL #51	3075
25	.045 (1.14) I.D.	.156 (3.96)			
26		.187 (4.75)			
27		.219 (5.56)			
33		.093 (2.36)			
34	.089 (2.26) O.D.	.125 (3.18)	.150 (3.8)	.093 (2.36) USE DRILL #42	3076
35	.070 (1.78) I.D.	.156 (3.96)			
36		.187 (4.75)			
37		.219 (5.56)			
43		.093 (2.36)			
44		.125 (3.18)			
45	.121 (3.07) O.D.	.156 (3.96)	.200 (5.1)	.125 (3.18) USE DRILL #30	3077
46	.102 (2.59) I.D.	.187 (4.75)			
47		.219 (5.56)			
48		.250 (6.35)			
14		.125 (3.18)			
15	.152 (3.86) O.D.	.156 (3.96)	.245 (6.2)	.156 (3.96) USE DRILL 5/32"	3079
16	.132 (3.35) I.D.	.187 (4.75)			
17		.219 (5.56)			

STAKING TOOLS

Set consisting of top and bottom tool.
Made from Tool Steel and highly polished.

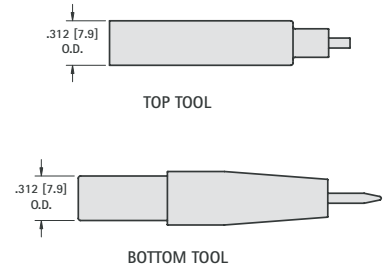

SEMI-TUBULAR RIVETS



These standardized brass rivets typify the scope and variety of popular rivets that will provide faster and stronger assemblies at lower cost. We suggest you rivet and test a sample before purchasing large quantities for your application.

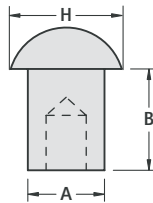

MATERIAL: Brass, Nickel Plate

CAT. NO.	B LENGTH UNDER HEAD	A SHANK DIAMETER	H HEAD DIAMETER	MTG. HOLE SIZE
3381	.125 (3.2)	.060 (1.55)	.109 (2.8)	.067 (1.70) Dia. USE DRILL #51
3382	.156 (3.9)			
3383	.187 (4.8)			
3384	.156 (3.9)	.087 (2.21)	.147 (3.7)	.093 (2.36) Dia. USE DRILL #42
3385	.187 (4.8)			
3386	.218 (5.5)			
3387	.250 (6.4)			
3388	.156 (3.9)	.120 (3.06)	.218 (5.5)	.128 (3.25) Dia. USE DRILL #30
3389	.187 (4.8)			
3390	.218 (5.5)			
3391	.250 (6.4)			

SNAP RIVETS



Attach panels and mounting hardware without any tooling. Leaves a clean cosmetic look once installed. Can be installed without access to underside. Removable so assembly can be easily repaired or upgraded.

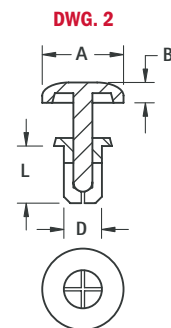
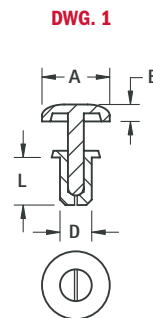
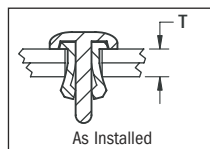

CAT. NO.	DWG.	T PANEL THICKNESS	L RIVET LENGTH	D RIVET DIAMETER	A HEAD DIAMETER	B HEAD HEIGHT	MTG. HOLE SIZE
3440	1	.051/.079 (1.3/2.0)	.130 (3.3)	.076 (1.9)	.165 (4.2)	.047 (1.2)	.083/.087 (2.1/2.2)
3441	1	.083/.110 (2.1/2.8)	.160 (4.0)				
3442	1	.114/.142 (2.9/3.6)	.190 (4.8)				
3443	2	.118/.157 (3.0/4.0)	.220 (5.6)	.138 (3.5)	.252 (6.4)	.063 (1.6)	.142/.146 (3.6/3.7)
3444	2	.146/.181 (3.7/4.6)	.240 (6.1)				
3445	2	.177/.217 (4.5/5.5)	.280 (7.1)				
3446	2	.217/.256 (5.5/6.5)	.310 (7.9)				
3447	2	.177/.217 (4.5/5.5)	.280 (7.1)	.158 (4.0)	.315 (8.0)	.071 (1.8)	.161/.165 (4.1/4.2)
3448	2	.217/.256 (5.5/6.5)	.310 (7.9)				
3449	2	.256/.295 (6.5/7.5)	.350 (9.0)				
3450	2	.295/.335 (7.5/8.5)	.390 (10.0)				

MATERIAL: Nylon 6/6, UL Rated 94V-2, Black

"BASIC" STAKING KIT

This kit provides the basic components needed to stake a majority of our most popular sizes of eyelets, rivets and terminals. The unskilled operator can produce professional looking assemblies quickly and with minimal training.

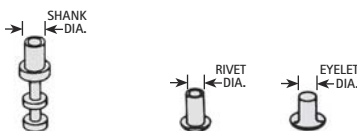

CAT. NO.	CONSISTS OF ONE EACH:
1714	Top Setting Tool
1715	
1719	
1716	Bottom Anvil
1717	

CAT. NO. 1721 COMPLETE KIT

"MASTER" STAKING KIT

This kit provides all of the components needed to stake most terminals, standoffs, eyelets or rivets. This kit also includes sprung receding pins so that eyelets can be prealigned for easy assembly of components. Kit supplied in convenient plastic case for ease of use.

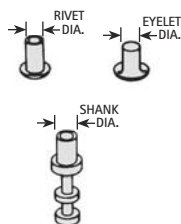
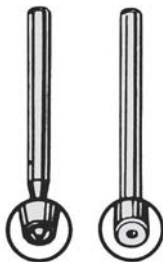

CAT. NO.	CONSISTS OF ONE EACH:
1714	Top Swaging Tool
1715	
1304	
1305	
1306	
1307	
1324	Anvil Holder
1719	
1325	Anvil for 6-32 Standoffs
1326	Anvil for Turret Terminals
1716	
1717	
1722	
1726	
1315	Receding Pin - .045 (1.15) Dia.
1316	Receding Pin - .069 (1.75) Dia.
1321	Return Spring for Receding Pins

CAT. NO. 1713 COMPLETE KIT

All that is required to stake almost all swage components. Just press down and it stakes. Tools provided allow bench top staking with out setting up arbor or drill press. Staking tool can be adjusted



CAT. NO. 1707 COMPLETE KIT

Tel (718) 956-8900 • Fax (718) 956-9040
(800) 221-5510 • kec@keyelco.com

KEYSTONE
RoHS COMPLIANT ~ ISO 9001 CERTIFIED

INDIVIDUAL TOOLS

TOP SETTING TOOLS (Swager)

1/4" Diameter Tools

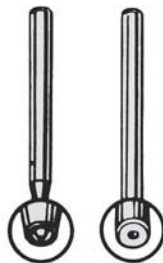

For Single End Terminals, Eyelets or Rivets

CAT. NO.	FOR SHANK DIA.
1714	.062 (1.57) to .098 (2.49)
1715	.110 (2.8) to .125 (3.2)
1328	.130 (3.3) to .140 (3.6)
1324	.180 (4.5) to .190 (4.8)

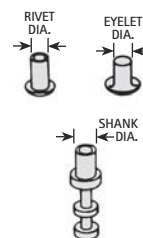

For Double End (Feed-Thru)
Hole in tool fits over Pin head and securely stakes the rivet part of terminal.

CAT. NO.	FOR PIN ON RIVET END
1304	.051 (1.30) Hole Dia.
1305	.063 (1.60) Hole Dia.
1306	.073 (1.85) Hole Dia.
1307	.086 (1.49) Hole Dia.
1324	.098 (2.49) Hole Dia.

BOTTOM ANVILS



For Single End Terminals or Double End Terminals

Anvils have different size holes in each end therefore will accept 2 sizes of Pins of either Single or Double end Turret Terminals.

CAT. NO.	A DIA.	B DIA.
1722	.053 (1.35)	.065 (1.65)
1716	.070 (1.78)	.100 (2.54)
1717	.128 (3.25)	.152 (3.86)

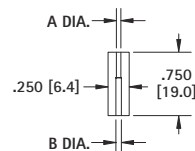

ANVILS FOR FORK TERMINALS



Accepts Diameter of 3/32 to 5/32 at one end and diameter of 3/16 other end .040 (1.0) slot one end and .060 (1.52) slot at other end.

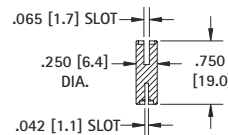

CAT. NO. 1726

ANVILS FOR SWAGE SPACERS

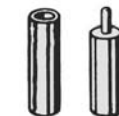

CAT. NO.	BUSHING SIZE
1326	Holds Bushing with 5/32" O.D.
1325	For Bushing with 6-32" Thread
1309	For Bushing with 4-40 Thread

TOOL HOLDERS



CAT. NO. 1719

Tool holders will hold all .250 (6.4) diameter anvils. May be used with receding pin and return spring to hold eyelets in place during the staking process.

"IMPACT" STAKING KIT

to provide heavy to light blows. Receding sprung pins can be assembled into anvil to locate eyelets for easy assembly of components. Kit supplied in convenient plastic case for ease of use.

CAT. NO.	CONSISTS OF ONE EACH:
TOOLS	
1302	Impact Handle
1300	Anvil Tool Holder Base
SWAGING TOOLS	
1312	.040 (1.02) to .072 (1.83)
1313	.078 (1.98) to .093 (2.36)
SWAGING TOOLS FOR DOUBLE ENDED TURRET	
1310	.053 (1.35) Diameter Hole
1311	.062 (1.57) Diameter Hole
ANVIL COMPONENTS	
1716	Anvil for Turret Terminals
1717	
1722	
1726	Anvil for Fork Turret Terminals
1315	Receding Pin - .045 (1.15) Dia.
1316	Receding Pin - .069 (1.75) Dia.
1321	Return Spring for Receding Pins

www.keyelco.com
31-07 20th Road - Astoria, NY 11105-2017

PTFE INSULATED TERMINALS & PINS



- Space saving design for high density packaging
- Outstanding Electrical, Mechanical, Thermal and Chemical properties
- Provides greater pull-out strength and high torque resistance
- Ideal for high quality terminal and connector applications
- Custom PTFE jacks manufactured to your specifications
- Other platings and bushing colors available upon request

SPECIFICATIONS

Terminal: Brass, Tin Plate

Bushing: White PTFE

Mounting Detail

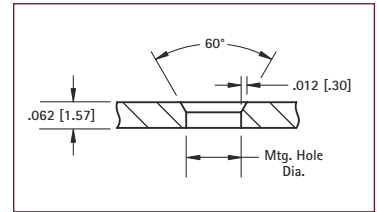

PINS



Top Mount

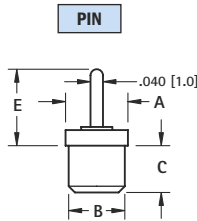

CAT. NO.	A	B	C	E	Mtg. Hole Dia.
11065	.125 (3.2)	.104 (2.6)	.089 (2.3)	.161 (4.1)	.091 (2.3)
11066	.125 (3.2)	.093 (2.4)	.100 (2.5)	.925 (23.5)	.086 (2.2)
11067	.172 (4.4)	.148 (3.8)	.100 (2.5)	.150 (3.8)	.136 (3.5)
11068	.172 (4.4)	.148 (3.8)	.075 (1.9)	.185 (4.7)	
11069	.172 (4.4)	.148 (3.8)	.050 (1.3)	.260 (6.6)	
11070	.172 (4.4)	.148 (3.8)	.075 (1.9)	.260 (6.6)	
11071	.172 (4.4)	.148 (3.8)	.100 (2.5)	.250 (6.4)	
11072	.172 (4.4)	.148 (3.8)	.160 (4.1)	.250 (6.4)	
11073	.172 (4.4)	.148 (3.8)	.100 (2.5)	.490 (12.4)	
11074	.172 (4.4)	.148 (3.8)	.100 (2.5)	.585 (14.9)	

SOLDER TERMINALS



Top Mount

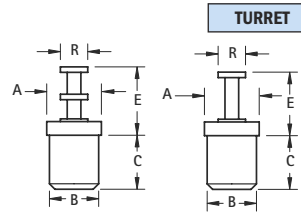

FIG. 1

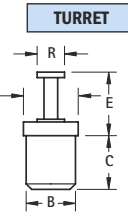

FIG. 2



Bottom Mount

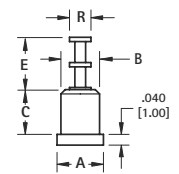

FIG. 3

CAT. NO.	FIG.	A	B	C	E	R	Mtg. Hole Dia.
11300	1	.125 (3.2)	.093 (2.4)	.100 (2.5)	.210 (5.3)	.060 (1.5)	.086 (2.2)
11301	1	.125 (3.2)	.093 (2.4)	.080 (2.0)	.250 (6.4)	.080 (2.0)	.086 (2.2)
11302	1	.125 (3.2)	.093 (2.4)	.100 (2.5)	.250 (6.4)	.080 (2.0)	.086 (2.2)
11303	1	.172 (4.4)	.148 (3.8)	.140 (3.6)	.194 (4.9)	.093 (2.4)	.136 (3.5)
11304	1	.172 (4.4)	.148 (3.8)	.110 (2.8)	.250 (6.4)	.080 (2.0)	.136 (3.5)
11305	1	.172 (4.4)	.148 (3.8)	.125 (3.2)	.303 (7.7)	.080 (2.0)	.136 (3.5)
11306	1	.172 (4.4)	.148 (3.8)	.165 (4.2)	.290 (7.4)	.093 (2.4)	.136 (3.5)
11307	1	.172 (4.4)	.148 (3.8)	.250 (6.4)	.290 (7.4)	.093 (2.4)	.136 (3.5)
11308	1	.172 (4.4)	.148 (3.8)	.165 (4.2)	.437 (11.1)	.093 (2.4)	.136 (3.5)
11320	2	.172 (4.4)	.148 (3.8)	.100 (2.5)	.150 (3.8)	.080 (2.0)	.136 (3.5)
11321	2	.187 (4.8)	.164 (4.2)	.150 (3.8)	.370 (9.4)	.090 (2.3)	.152 (3.9)
11322*	2	.150 (3.8)	.125 (3.2)	.110 (2.8)	.180 (4.6)	.090 (2.3)	.113 (2.9)
11310	2	.125 (3.2)	.093 (2.4)	.100 (2.5)	.170 (4.3)	.060 (1.5)	.086 (2.2)
11311	3	.172 (4.4)	.148 (3.8)	.100 (2.5)	.210 (5.3)	.080 (2.0)	.136 (3.5)
11312	3	.187 (4.8)	.171 (4.3)	.155 (3.9)	.210 (5.3)	.080 (2.0)	.158 (4.0)

*Hollow Turret

PIN



Bottom Mount

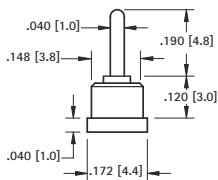

CAT. NO. 11075

Mtg. Hole
.136 (3.5) Dia.

HOLLOW PIN

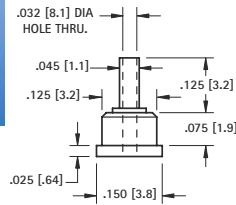

CAT. NO. 11076

Mtg. Hole
.113 (2.9) Dia.

PIN-TO-PIN



Feed-Through

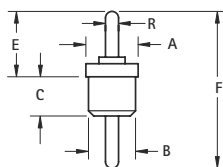

CAT. NO.	A	B	C	E	F	R	Mtg. Hole Dia.
11150	.093 (2.4)	.075 (1.9)	.100 (2.5)	.315 (8.0)	.550 (13.9)	.030 (7.6)	.069 (1.8)
11151	.125 (3.2)	.093 (2.4)	.100 (2.5)	.196 (5.0)	.453 (11.5)	.040 (1.0)	.136 (3.5)
11152	.125 (3.2)	.093 (2.4)	.100 (2.5)	.250 (6.4)	.515 (13.1)	.040 (1.0)	
11153	.125 (3.2)	.093 (2.4)	.100 (2.5)	.250 (6.4)	.443 (11.3)	.040 (1.0)	
11154	.150 (3.8)	.125 (3.2)	.100 (2.5)	.250 (6.4)	.443 (11.3)	.040 (1.0)	
11155	.172 (4.4)	.148 (3.8)	.100 (2.5)	.250 (6.4)	.515 (13.1)	.040 (1.0)	
11156	.172 (4.4)	.148 (3.8)	.110 (2.8)	.260 (6.6)	.535 (13.6)	.040 (1.0)	
11157	.172 (4.4)	.148 (3.8)	.250 (6.4)	.250 (6.4)	.710 (18.0)	.040 (1.0)	
11158	.172 (4.4)	.148 (3.8)	.250 (6.4)	.303 (7.7)	.719 (18.3)	.040 (1.0)	
11159	.172 (4.4)	.148 (3.8)	.160 (4.1)	.250 (6.4)	.725 (18.4)	.040 (1.0)	
11160	.172 (4.4)	.148 (3.8)	.170 (4.3)	.250 (6.4)	.630 (16.0)	.040 (1.0)	

TURRET-TO-TURRET



Feed-Through

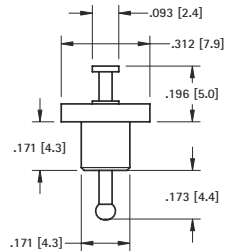

CAT. NO. 11250

Mtg. Hole
.158 (4.0) Dia.

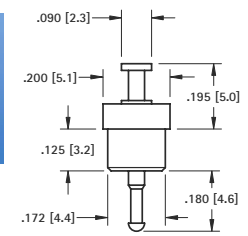

CAT. NO. 11251

Mtg. Hole
.158 (4.0) Dia.

TURRET-TO-PIN



Feed-Through

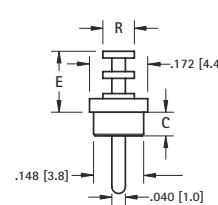

CAT. NO.	C	E	R	Mtg. Hole Dia.
11216	.100 (2.5)	.250 (6.4)	.080 (2.0)	.136 (3.5)
11217	.230 (5.8)	.375 (9.5)	.093 (2.4)	



Feed-Through

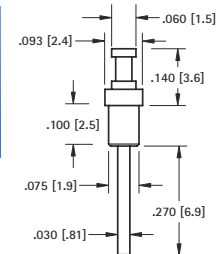

CAT. NO. 11218

Mtg. Hole
.066 (1.7) Dia.

SPLIT-TYPE FORK TURRETS

FORK

SPECIFICATIONS

Terminal: Brass, Tin Plate
Bushing: White PTFE

FORK-TO-TURRET

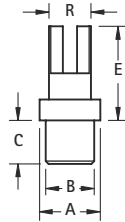
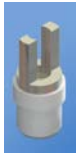

FIG. 1

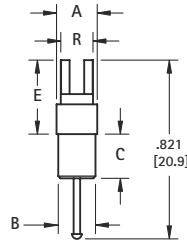

FIG. 2

CAT. NO.	FIG. NO.	A	B	C	E	R	Mtg. Hole Dia.
11100	1	.172 (4.4)	.148 (3.8)	.125 (3.2)	.250 (6.4)	.125 (3.2)	.136 (3.5)
11111	1	.187 (4.8)	.171 (4.3)	.150 (3.8)	.390 (9.9)	.148 (3.8)	.158 (4.0)
11112	1	.187 (4.8)	.171 (4.3)	.150 (3.8)	.453 (11.5)		
11113	1	.187 (4.8)	.171 (4.3)	.150 (3.8)	.328 (8.3)		
11114	1	.187 (4.8)	.171 (4.3)	.150 (3.8)	.390 (9.9)		
11115	1	.187 (4.8)	.171 (4.3)	.150 (3.8)	.453 (11.5)		
11116	2	.187 (4.8)	.171 (4.3)	.212 (5.4)	.390 (9.9)		

THREADED TURRET TERMINALS

SPECIFICATIONS

Terminal: Brass, Tin Plate
Bushing: White PTFE

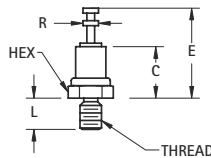

CAT. NO.	Thread	Hex	C	E	L	R
11350	2-56	.156 (3.9)	.206 (5.2)	.360 (9.1)	.125 (3.2)	.062 (1.6)
11351	4-40	.250 (6.4)	.270 (6.9)	.510 (12.9)	.250 (6.4)	.094 (2.4)
11352	6-32	.250 (6.4)	.270 (6.9)	.510 (12.9)	.375 (9.5)	.094 (2.4)

THREADED FEED - THRU TERMINALS

SPECIFICATIONS

Terminal: Brass, Tin Plate
Bushing: White PTFE
Body: Brass, Nickel Plate

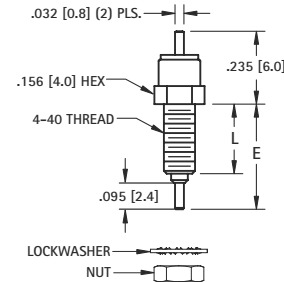

CAT. NO.	E	L
11360	.328 (8.3)	.200 (5.1)
11361	.378 (9.6)	.250 (6.4)

Nut and washer supplied unassembled

SPECIFICATIONS

Terminal: Brass, Tin Plate
Bushing: White PTFE
Body: Brass, Nickel Plate

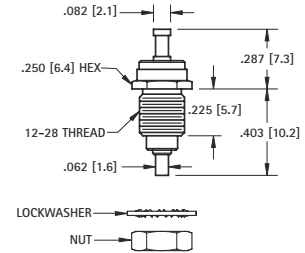

CAT. NO. 11362

Nut and washer supplied unassembled

SPECIFICATIONS

Terminal: Brass, Tin Plate
Bushing: White PTFE
Body: Brass, Nickel Plate

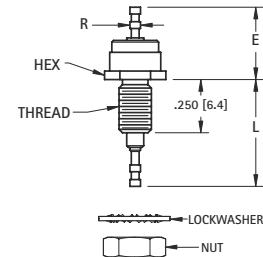

Nut and washer supplied unassembled

CAT. NO.	Thread	Hex	E	L	R
11363	10-32	.312 (7.9)	.425 (10.8)	.565 (14.3)	.062 (1.6)
11364	6-32	.188 (4.8)	.368 (9.3)	.510 (12.9)	.040 (1.0)

MOLDED DIALLYL PHTHALATE INSULATED THREADED TERMINALS

MATERIAL:

Terminal: Brass, Tin Plate
Insulator: Blue Molded Diallyl Phthalate, SDG
Base: Brass, Tin Plate

Properties:

- High Dielectric Breakdown
- Continuous Use Temperature up to 350°F (176 °C)
- UL 94 V-O Rated
- Other platings and insulator colors available upon request

SINGLE TURRET TO MALE THREAD

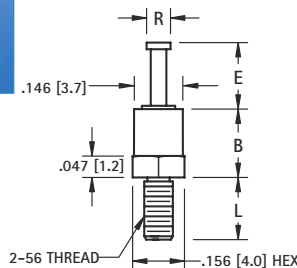

CAT. NO.	B	E	L	R
11500	.235 (6.0)	.156 (4.0)	.125 (3.2)	.072 (1.8)
11501	.235 (6.0)	.218 (5.5)	.125 (3.2)	.072 (1.8)
11502	.235 (6.0)	.218 (5.5)	.187 (4.8)	.072 (1.8)

SINGLE TURRET TO FEMALE THREAD

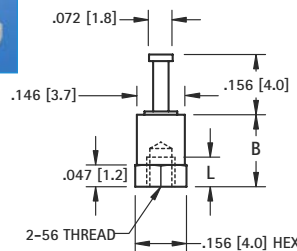

CAT. NO.	L	B
11510	.078 (2.0)	.235 (5.9)
11511	.117 (3.0)	.391 (9.9)

DOUBLE TURRET TO FEMALE THREAD

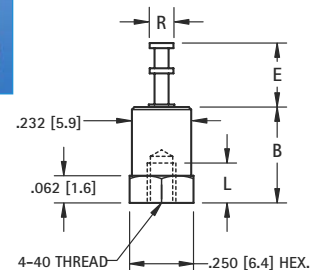

CAT. NO.	B	E	L	R
11512	.375 (9.5)	.219 (5.6)	.156 (4.0)	.093 (2.4)
11513	.594 (15.1)	.344 (8.7)	.219 (5.6)	.140 (3.6)

TURRET TERMINALS

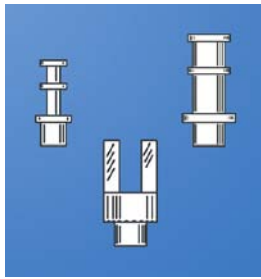

STYLES

- Single, double and triple turrets
- Double-ended (feed-thru)
- Split-type (fork)
- Tubular (hollow)
- Swage and thread mounting types available
- Bright Tin plated for extended shelf life and excellent solderability
- Wide variety of sizes to suit space and wire size requirements

SPECIFICATIONS

MATERIAL: Brass - Per ASTM-B16, Bright Electro-Tin per MIL-T-10727 Type 1. Other platings available upon request.

SPECIAL TERMINALS

Custom terminals can be manufactured to your specifications. Complete facilities available to meet your production requirements. Quotations on special terminals furnished promptly upon receipt of sample, sketch or print.

CUSTOM BUILT TERMINAL BOARDS

We are specialists in the assembly of terminals, eyelets, clips and special hardware. Quotations on special terminal boards furnished promptly upon receipt of sample, sketch or print. Assembly service using customer supplied materials also available. (Refer to pages 130-132 for standard terminal boards.)

ORDERING INFORMATION

Keystone standardized terminals are available for various board thicknesses.

To specify a terminal, select the "CAT. NO." and "DASHED NUMBER" that corresponds with the board thickness to be used.

DASH NUMBERS (Board Thicknesses)

- 1 for .032 (.81) thick Board
- 2 for .062 (1.57) thick Board
- 3 for .093 (2.36) thick Board
- 4 for .125 (3.2) thick Board

Example: 1503-1 for .032 (.81) thick Board
1503-2 for .062 (1.57) thick Board

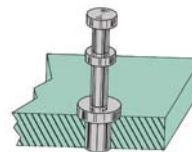

STAKING TOOLS

For easy mounting of terminals to insulators and PC boards. Standard and "special order" staking tools are available. Cat. No. "TL" designates a tool consisting of a TOP STAKING PUNCH and a BOTTOM ANVIL. Manufactured from steel with zinc plate. Punch and anvil are precision machined and hardened to insure long life. Refer to page 135.

CUSTOM BUILT STAKING TOOLS

Custom prototype and production staking tools can be furnished for Single-End, Double-End, Fork Terminals, Extruded Lugs, Eyelets, Rivets, etc. Contact our Engineering Department for details.



SINGLE, DOUBLE & TRIPLE TURRET

1528

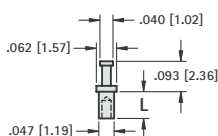

Staking Tool 1528-TL

CAT. NO.	L
1528-1	.051 (1.30)
1528-2	.082 (2.08)
1528-3	.113 (2.8)
1528-4	.145 (3.6)

1508

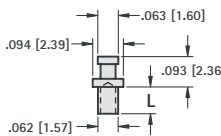

Staking Tool No. TL-1

CAT. NO.	L
1508-1	.053 (1.35)
1508-2	.084 (2.13)
1508-3	.115 (2.9)
1508-4	.147 (3.7)

1572

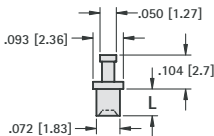

Staking Tool No. TL-1

CAT. NO.	L
1572-1	.051 (1.30)
1572-2	.082 (2.08)
1572-3	.113 (2.8)
1572-4	.145 (3.6)

1520

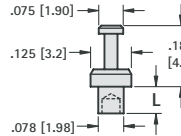

Staking Tool No. TL-2

CAT. NO.	L
1520-1	.078 (1.98)
1520-2	.109 (2.8)
1520-3	.141 (3.5)
1520-4	.172 (4.4)

1532

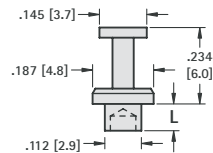

Staking Tool No. TL-8

CAT. NO.	L
1532-1	.078 (1.98)
1532-2	.109 (2.8)
1532-3	.141 (3.5)
1532-4	.172 (4.4)

1593

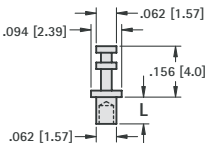

Staking Tool No. TL-1

CAT. NO.	L
1593-1	.054 (1.37)
1593-2	.084 (2.13)
1593-3	.115 (2.9)
1593-4	.147 (3.7)

1573

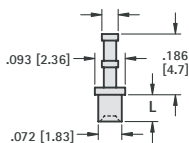

Staking Tool No. TL-1

CAT. NO.	L
1573-1	.051 (1.30)
1573-2	.082 (2.08)
1573-3	.113 (2.8)
1573-4	.145 (3.6)

1502

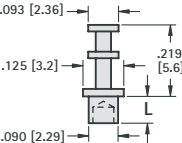

Staking Tool No. TL-2

CAT. NO.	L
1502-1	.078 (1.98)
1502-2	.109 (2.8)
1502-3	.141 (3.5)
1502-4	.172 (4.4)

1514

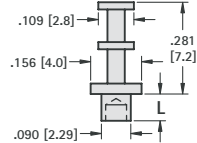

Staking Tool No. TL-5

CAT. NO.	L
1514-1	.078 (1.98)
1514-2	.109 (2.8)
1514-3	.141 (3.5)
1514-4	.172 (4.4)

1503

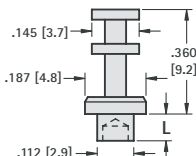

Staking Tool No. TL-8

CAT. NO.	L
1503-1	.078 (1.98)
1503-2	.109 (2.8)
1503-3	.141 (3.5)
1503-4	.172 (4.4)

1598

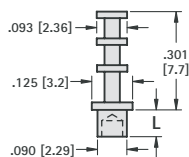

Staking Tool No. TL-2

CAT. NO.	L
1598-1	.062 (1.57)
1598-2	.094 (2.39)
1598-3	.125 (3.2)
1598-4	.156 (3.9)

1527

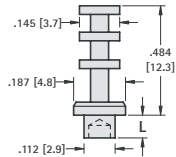

Staking Tool No. TL-8

CAT. NO.	L
1527-1	.078 (1.98)
1527-2	.109 (2.8)
1527-3	.141 (3.5)
1527-4	.172 (4.4)

THREADED TURRETS

1563

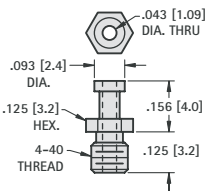

CAT. NO. 1563

1595

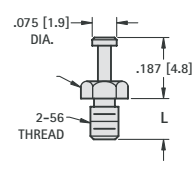

CAT. NO.	L
1595-1	.093 (2.36)
1595-2	.125 (3.2)
1595-3	.188 (4.8)

1587

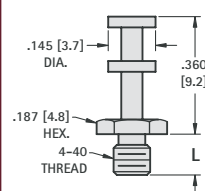

CAT. NO.	L
1587-1	.125 (3.2)
1587-2	.188 (4.8)

SPLIT-TYPE (FORK) TURRETS

1515

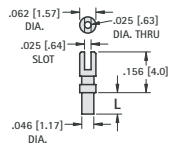

Staking Tool 1515-TL

CAT. NO.	L
1515-1	.058 (1.47)
1515-2	.089 (2.26)
1515-3	.120 (3.1)
1515-4	.150 (3.8)

1533

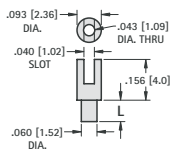

Staking Tool Special Order

CAT. NO.	L
1533-2	.084 (2.13)
1533-3	.115 (2.9)
1533-4	.147 (3.7)

1526

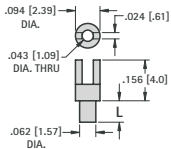

Staking Tool No. TL-3

CAT. NO.	L
1526-1	.054 (1.37)
1526-2	.084 (2.13)
1526-3	.115 (2.9)
1526-4	.147 (3.7)

1592

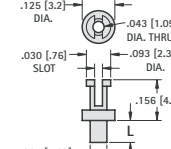

Staking Tool No. TL-2

CAT. NO.	L
1592-1	.051 (1.30)
1592-2	.082 (2.08)
1592-3	.113 (2.8)
1592-4	.145 (3.6)

1511

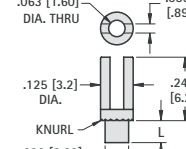

Staking Tool No. TL-3

CAT. NO.	L
1511-2	.109 (2.8)
1511-3	.141 (3.5)
1511-4	.172 (4.4)

1510

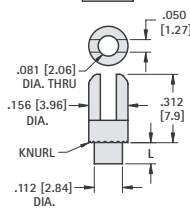

Staking Tool No. TL-9

CAT. NO.	L
1510-2	.109 (2.8)
1510-3	.141 (3.5)
1510-4	.172 (4.4)

1525

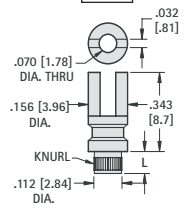

Staking Tool No. TL-9

CAT. NO.	L
1525-2	.109 (2.8)
1525-3	.141 (3.5)
1525-4	.172 (4.4)

1507

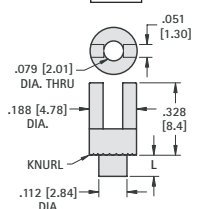

Staking Tool No. TL-9

CAT. NO.	L
1507-2	.109 (2.8)
1507-3	.141 (3.5)
1507-4	.172 (4.4)

1557

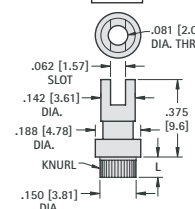

Staking Tool Special Order

CAT. NO.	L
1557-2	.109 (2.8)
1557-3	.141 (3.5)
1557-4	.172 (4.4)

SPECIAL TURRET TERMINALS

Custom turret terminals can be machined to your exact specifications. Standard and special terminals can be staked onto special boards. Please email/fax your design to our Engineering Department.

TUBULAR TURRETS

1562

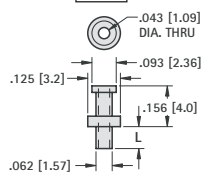

Staking Tool No. TL-2

CAT. NO.	L
1562-1	.054 (1.37)
1562-2	.084 (2.13)
1562-3	.115 (2.9)
1562-4	.147 (3.7)

1559

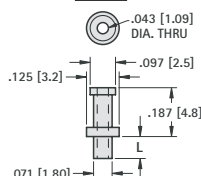

Staking Tool No. TL-2

CAT. NO.	L
1559-1	.062 (1.57)
1559-2	.094 (2.39)
1559-3	.125 (3.2)
1559-4	.156 (3.9)

DOUBLE-ENDED TURRETS

1633

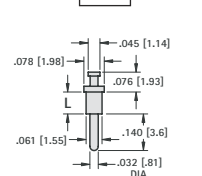

Staking Tool Special Order

CAT. NO.	L
1633-1	.051 (1.30)
1633-2	.082 (2.08)
1633-3	.113 (2.8)
1633-4	.145 (3.6)

1574

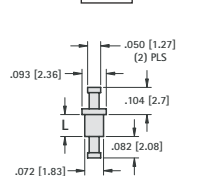

Staking Tool No. TL-4

CAT. NO.	L
1574-1	.051 (1.30)
1574-2	.082 (2.08)
1574-3	.113 (2.8)
1574-4	.145 (3.6)

1540

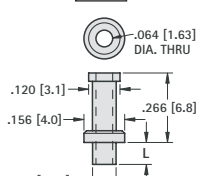

Staking Tool No. TL-5

CAT. NO.	L
1540-2	.107 (2.7)
1540-3	.141 (3.5)
1540-4	.172 (4.4)

1519

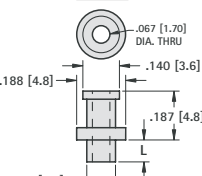

Staking Tool No. TL-8

CAT. NO.	L
1519-1	.078 (1.98)
1519-2	.109 (2.8)
1519-3	.141 (3.5)
1519-4	.172 (4.4)

1613

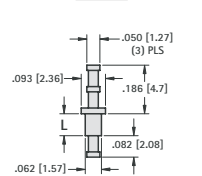

Staking Tool No. TL-4

CAT. NO.	L
1613-1	.051 (1.30)
1613-2	.082 (2.08)
1613-3	.113 (2.8)
1613-4	.145 (3.6)

1575

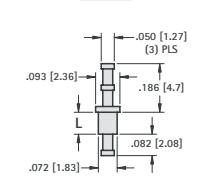

Staking Tool No. TL-4

CAT. NO.	L
1575-1	.051 (1.30)
1575-2	.082 (2.08)
1575-3	.113 (2.8)
1575-4	.145 (3.6)

1582

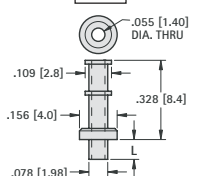

Staking Tool No. TL-5

CAT. NO.	L
1582-1	.075 (1.91)
1582-2	.105 (2.7)
1582-3	.135 (3.4)
1582-4	.165 (4.2)

1509

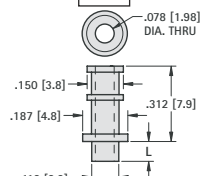

Staking Tool No. TL-8

CAT. NO.	L
1509-1	.078 (1.98)
1509-2	.109 (2.8)
1509-3	.141 (3.5)
1509-4	.172 (4.4)

1583

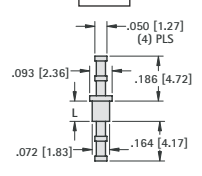

Staking Tool No. TL-4

CAT. NO.	L
1583-1	.051 (1.30)
1583-2	.082 (2.08)
1583-3	.113 (2.8)
1583-4	.145 (3.6)

1545

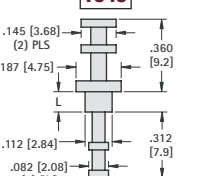

Staking Tool No. TL-12

CAT. NO.	L
1545-2	.105 (2.7)
1545-3	.135 (3.4)
1545-4	.165 (4.2)

TURRET TERMINALS

SCORED TURRET TERMINAL BOARDS

Cut your production cost by eliminating the tooling and setup charge usually applied to non-standardized boards. Terminals are securely staked and tinned for easy soldering.

MATERIAL: Choice of either PBE or GEE.

PBE: Paper base electrical, MIL-1-24768/20, Type XP natural, Temp. 250°F (121°C) max.

GEE: Glass epoxy, MIL-1-24768/27, Type G-10, Temp. 300°F (155°C) max.

Terminals: Brass, ASTM-B16, Tin Plate, MIL-T-10727. Other platings can be furnished.

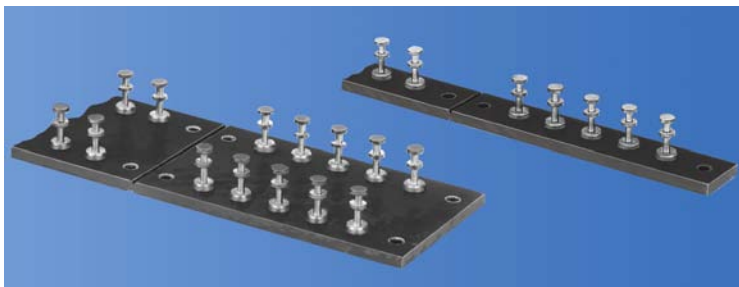

MODIFICATIONS

Boards can be modified with other materials or terminals of your choice. Marking can also be added. Quotations upon request.

STANDARD TURRET TERMINAL BOARDS

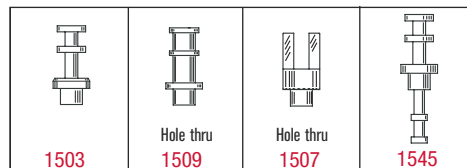
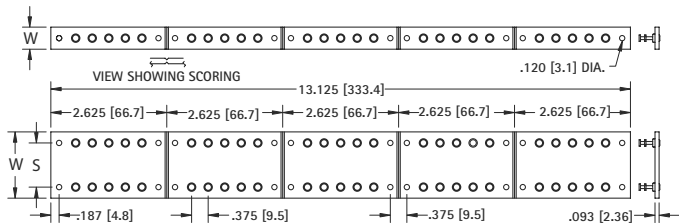

- Choice of 4 Types of Terminals**
- Five sections **SCORED** for easy separation.
 - Mounting holes in each section.

W	S	NO. OF TERMS	MATERIAL	CAT. NO.	CAT. NO.	CAT. NO.	CAT. NO.
.500 (12.7)	Single Row	25	PBE	15031	15091	15071	15041
			GEE	15231	15291	15271	15241
1.500 (38.1)	1.000 (25.4)	50	PBE	15032	15092	15072	15042
			GEE	15232	15292	15272	15242
1.500 (38.1)	1.187 (30.1)	50	PBE	15036	15096	15076	15046
			GEE	15236	15296	15276	15246
2.000 (50.8)	1.500 (38.1)	50	PBE	15033	15093	15073	15043
			GEE	15233	15293	15273	15243
2.500 (63.5)	2.000 (50.8)	50	PBE	15034	15094	15074	15044
			GEE	15234	15294	15274	15244
3.000 (76.2)	2.500 (63.5)	50	PBE	15035	15095	15075	15045
			GEE	15235	15295	15275	15245

MINIATURE TURRET TERMINAL BOARDS

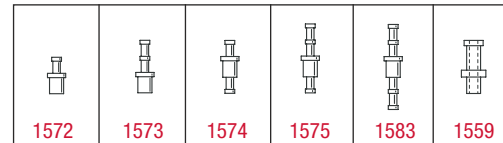
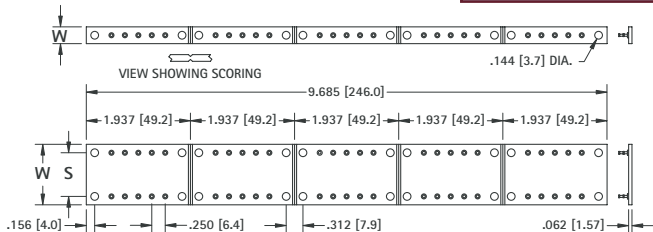

- Choice of 6 Types of Terminals**
- Five sections **SCORED** for easy separation.
 - Mounting holes in each section.

W	S	NO. OF TERMS	MATERIAL	CAT. NO.	CAT. NO.	CAT. NO.	CAT. NO.	CAT. NO.	CAT. NO.
.312 (7.9)	Single Row	25	PBE	15047	15057	15067	15077	15087	15097
			GEE	15247	15257	15267	15277	15287	15297
.875 (22.2)	.562 (14.3)	50	PBE	15048	15058	15068	15078	15088	15098
			GEE	15248	15258	15268	15278	15288	15298
1.125 (28.6)	.812 (20.6)	50	PBE	15049	15059	15069	15079	15089	15099
			GEE	15249	15259	15269	15279	15289	15299

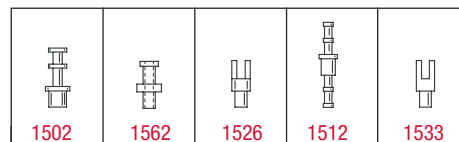
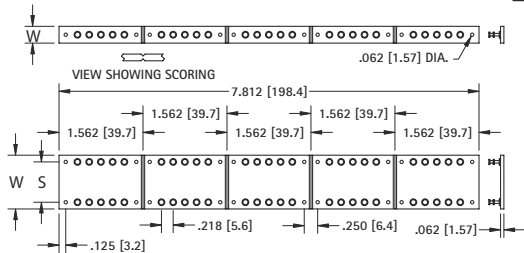

- Choice of 5 Types of Terminals**
- Five sections **SCORED** for easy separation.
 - Mounting holes in each section.

W	S	NO. OF TERMS	MATERIAL	CAT. NO.	CAT. NO.	CAT. NO.	CAT. NO.	CAT. NO.
.312 (7.9)	Single Row	25	PBE	15021	15023	15025	15063	15053
			GEE	15221	15223	15225	15263	15253
.875 (22.2)	.500 (12.7)	50	PBE	15028	15029	15026	15064	15054
			GEE	15228	15229	15226	15264	15254
1.000 (25.4)	.750 (19.1)	50	PBE	15022	15024	15030	15065	15056
			GEE	15222	15224	15230	15265	15256

SCORED TURRET TERMINAL BOARDS

MINIATURE TURRET TERMINAL BOARDS

MATERIAL: Choice of either PBE or GEE.

PBE: Paper base electrical, MIL-1-24768/20, Type XP natural, Temp. 250°F (121°C) max.

GEE: Glass Epoxy, MIL-I-24768/27, Type G-10, Temp. 300°F (155°C) max.

Terminals: Brass, ASTM-B16, Tin Plate, MIL-T-10727. Other platings can be furnished.

MODIFICATIONS

Boards can be modified with other materials or terminals of your choice. Marking can also be added. Quotations upon request.

DOUBLE TURRET TERMINAL

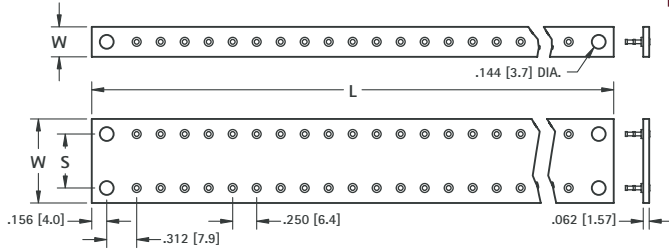
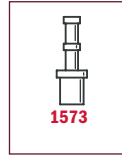
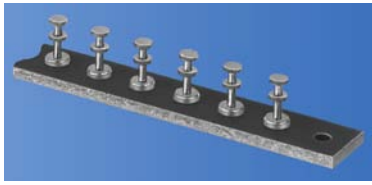

W	S	L	NO. OF TERMS EACH SIDE	MATERIAL PBE CAT. NO.	MATERIAL GEE CAT. NO.
.312 (7.9)	Single Row	1.937 (49.2)	5	15431	15531
		3.687 (93.6)	12	15432	15532
		5.437 (138.1)	19	15433	15533
		7.187 (182.5)	26	15434	15534
.875 (22.2)	.562 (14.3)	1.937 (49.2)	5	15436	15536
		3.687 (93.6)	12	15437	15537
		5.437 (138.1)	19	15438	15538
		7.187 (182.5)	26	15439	15539
1.125 (28.6)	.812 (20.6)	1.937 (49.2)	5	15441	15541
		3.687 (93.6)	12	15442	15542
		5.437 (138.1)	19	15443	15543
		7.187 (182.5)	26	15444	15544
		8.937 (227.0)	33	15445	15545

Terminals are staked in all except end mounting holes.

THRU HOLE TERMINAL

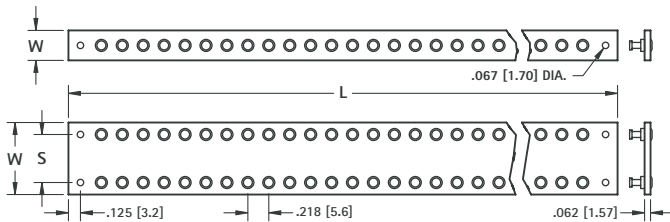
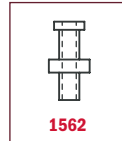

W	S	L	NO. OF TERMS EACH SIDE	MATERIAL PBE CAT. NO.	MATERIAL GEE CAT. NO.
.312 (7.9)	Single Row	1.562 (39.7)	5	15401	15501
		3.093 (78.6)	12	15402	15502
		4.625 (117.5)	19	15403	15503
		6.156 (156.4)	26	15404	15504
		7.687 (195.2)	33	15405	15505
.750 (19.1)	.500 (12.7)	1.562 (39.7)	5	15406	15506
		3.093 (78.6)	12	15407	15507
		4.625 (117.5)	19	15408	15508
		6.156 (156.4)	26	15409	15509
		7.687 (195.2)	33	15410	15510
1.000 (25.4)	.750 (19.1)	1.562 (39.7)	5	15411	15511
		3.093 (78.6)	12	15412	15512
		4.625 (117.5)	19	15413	15513
		6.156 (156.4)	26	15414	15514
		7.687 (195.2)	33	15415	15515

Terminals are staked in all except end mounting holes.

MILITARY TERMINAL BOARDS

Terminal boards are manufactured as per Military specifications MS27249.

SPECIFICATIONS

Board Material: MIL-I-24768/27 TYPE GEE or TYPE GEB. MIL-1-24768/3 .125 (3.2)

Terminal: SE12XC09 PER MIL-T-55155 Tin/Lead Plated (Non-RoHS Compliant)

- Five sections **SCORED** for easy separation.
- Mounting holes in each section.

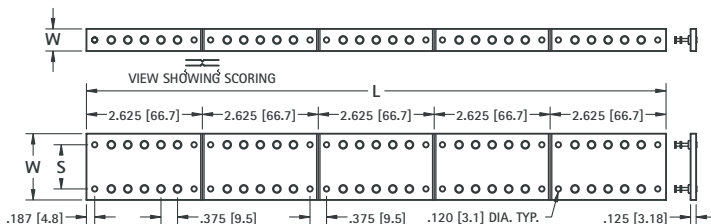
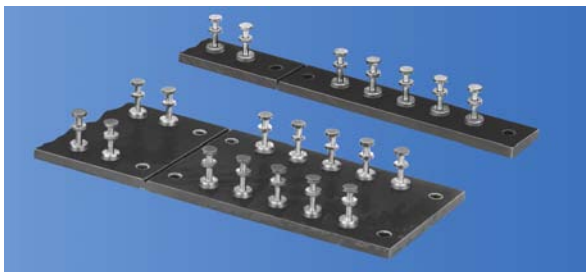
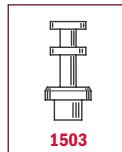

W	S	L	NO. OF TERMS EACH SIDE	MATERIAL GEB CAT. NO.	MATERIAL GEE CAT. NO.
.500 (12.7)	Single Row	2.625 (66.7)	5	MS27249-1B1	MS27249-1E1
		5.250 (133.4)	10	MS27249-1B2	MS27249-1E2
		7.875 (200.0)	15	MS27249-1B3	MS27249-1E3
		10.500 (266.7)	20	MS27249-1B4	MS27249-1E4
		13.125 (333.4)	25	MS27249-1B5	MS27249-1E5
1.500 (38.1)	1.000 (25.4)	2.625 (66.7)	5	MS27249-2B1	MS27249-2E1
		5.250 (133.4)	10	MS27249-2B2	MS27249-2E2
		7.875 (200.0)	15	MS27249-2B3	MS27249-2E3
		10.500 (266.7)	20	MS27249-2B4	MS27249-2E4
		13.125 (333.4)	25	MS27249-2B5	MS27249-2E5
2.000 (50.8)	1.500 (38.1)	2.625 (66.7)	5	MS27249-3B1	MS27249-3E1
		5.250 (133.4)	10	MS27249-3B2	MS27249-3E2
		7.875 (200.0)	15	MS27249-3B3	MS27249-3E3
		10.500 (266.7)	20	MS27249-3B4	MS27249-3E4
		13.125 (333.4)	25	MS27249-3B5	MS27249-3E5
2.500 (63.5)	2.000 (50.8)	2.625 (66.7)	5	MS27249-4B1	MS27249-4E1
		5.250 (133.4)	10	MS27249-4B2	MS27249-4E2
		7.875 (200.0)	15	MS27249-4B3	MS27249-4E3
		10.500 (266.7)	20	MS27249-4B4	MS27249-4E4
		13.125 (333.4)	25	MS27249-4B5	MS27249-4E5
3.000 (76.2)	2.500 (63.5)	2.625 (66.7)	5	MS27249-5B1	MS27249-5E1
		5.250 (133.4)	10	MS27249-5B2	MS27249-5E2
		7.875 (200.0)	15	MS27249-5B3	MS27249-5E3
		10.500 (266.7)	20	MS27249-5B4	MS27249-5E4
		13.125 (333.4)	25	MS27249-5B5	MS27249-5E5

TURRET TERMINAL BOARDS

- Save Tooling • Economical • Complete Range of Sizes

Ready-Made Terminal Boards: Low cost, meets commercial and military specifications. Produced in large quantities, making it possible to eliminate tooling and setup charges usually applied to non-standard boards.

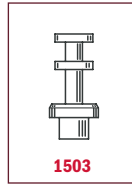
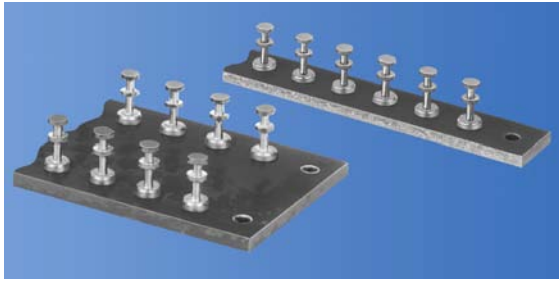

BOARDS ON THIS PAGE ARE NOT SCORED

W	S	L	NO. OF TERMS EACH SIDE	MATERIAL PBE CAT. NO.	MATERIAL GEE CAT. NO.
.500 [12.7]	Single Row	2.625 (66.7)	5	15101	15301
		5.250 (133.4)	12	15102	15302
		7.875 (200.0)	19	15103	15303
		10.500 (266.7)	26	15104	15304
		13.125 (333.4)	33	15105	15305
1.188 (30.2)	.750 (19.1)	2.625 (66.7)	5	15106	15306
		5.250 (133.4)	12	15107	15307
		7.875 (200.0)	19	15108	15308
		10.500 (266.7)	26	15109	15309
		13.125 (333.4)	33	15110	15310
1.500 (38.1)	1.000 (25.4)	2.625 (66.7)	5	15111	15311
		5.250 (133.4)	12	15112	15312
		7.875 (200.0)	19	15113	15313
		10.500 (266.7)	26	15114	15314
		13.125 (333.4)	33	15115	15315
2.000 (50.8)	1.500 (38.1)	2.625 (66.7)	5	15116	15316
		5.250 (133.4)	12	15117	15317
		7.875 (200.0)	19	15118	15318
		10.500 (266.7)	26	15119	15319
		13.125 (333.4)	33	15120	15320
2.500 (63.5)	2.000 (50.8)	2.625 (66.7)	5	15121	15321
		5.250 (133.4)	12	15122	15322
		7.875 (200.0)	19	15123	15323
		10.500 (266.7)	26	15124	15324
		13.125 (333.4)	33	15125	15325
3.000 (76.2)	2.500 (63.5)	2.625 (66.7)	5	15126	15326
		5.250 (133.4)	12	15127	15327
		7.875 (200.0)	19	15128	15328
		10.500 (266.7)	26	15129	15329
		13.125 (333.4)	33	15130	15330

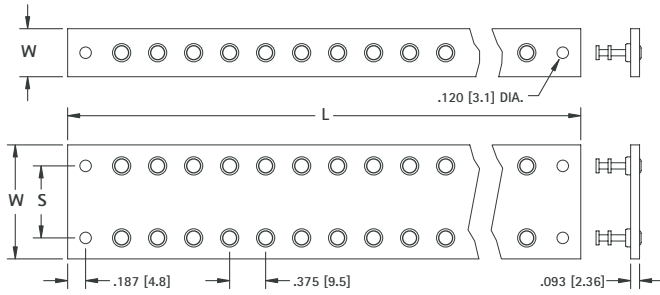

MATERIAL: Choice of either PBE or GEE.

PBE: Paper base electrical, MIL-1-24768/20, Type XP natural, Temp. 250°F (121°C) max.

GEE: Glass epoxy, MIL-1-24768/27, Type G-10, Temp. 300°F (155°C) max.

Terminals: Brass, ASTM-B16. Tin Plate, MIL-T-10727. Other plating can be furnished.

MODIFICATIONS

Boards can be modified with other materials or terminals of your choice. Marking can also be added. Quotations upon request.

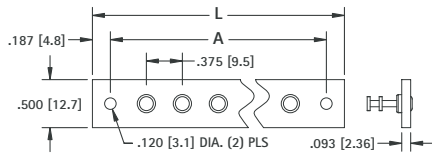

Terminals are staked in all holes except end mounting holes.

MATERIAL: PBE

PBE: Paper base electrical, FED. LP-513, Type XP natural, Temp. 250°F (121°C) max.

Terminals: Brass, ASTM-B16. Tin Plate, MIL-T-10727.

Other plating can be furnished.

L	A	NO. OF TERMS	1503 CAT. NO.	1509 CAT. NO.	1545 CAT. NO.	1507 CAT. NO.
1.125 (28.6)	7.50 (19.1)	1	603-1	609-1	604-1	607-1
1.500 (38.1)	1.125 (28.6)	2	603-2	609-2	604-2	607-2
1.875 (47.6)	1.500 (38.1)	3	603-3	609-3	604-3	607-3
2.250 (57.2)	1.875 (47.6)	4	603-4	609-4	604-4	607-4
2.625 (66.7)	2.250 (57.2)	5	603-5	609-5	604-5	607-5
3.000 (76.2)	2.625 (66.7)	6	603-6	609-6	604-6	607-6
3.375 (85.7)	3.000 (76.2)	7	603-7	609-7	604-7	607-7
3.750 (95.3)	3.375 (85.7)	8	603-8	609-8	604-8	607-8
4.125 (104.8)	3.750 (95.3)	9	603-9	609-9	604-9	607-9
4.500 (114.3)	4.125 (104.8)	10	603-10	609-10	604-10	607-10

QUICK-FIT TERMINAL STRIPS

MATERIAL: Fiberglass - NEMA GRADE GPO-3.

A glass polyester rated for continuous operation at 300°F (155°C) .062 (1.57)

Backing Strips: .031 (.79) fibre with mounting holes drilled only

Terminals: Brass



CAT. NO. 1257 .032 (.81) Bright Brass
Other platings available on special order

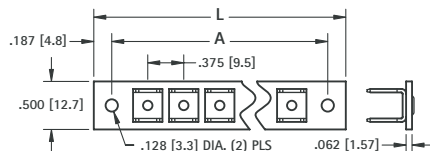

.250 (6.4) TABS



BACKING INSULATOR
.031 (.79)
FIBER

L LENGTH	A MTG. CENTERS	NO. TERM. EACH SIDE	CAT. NO.	BACKING STRIP CAT. NO.
1.500 (38.1)	1.125 (28.6)	2	4116	4401
2.250 (57.2)	1.875 (47.6)	4	4117	4402
3.000 (76.2)	2.625 (66.7)	6	4118	4403
3.750 (95.3)	3.375 (85.7)	8	4119	4404
4.500 (114.3)	4.125 (104.8)	10	4120	4405

TERMINAL STRIPS (STANDARD & MINIATURE)

Tin plated lugs and brackets. Bakelite XP .062 (1.57) thick. In addition to the strips shown, we manufacture many other varieties in any configuration and materials required. Send samples or sketch for prompt quotation.

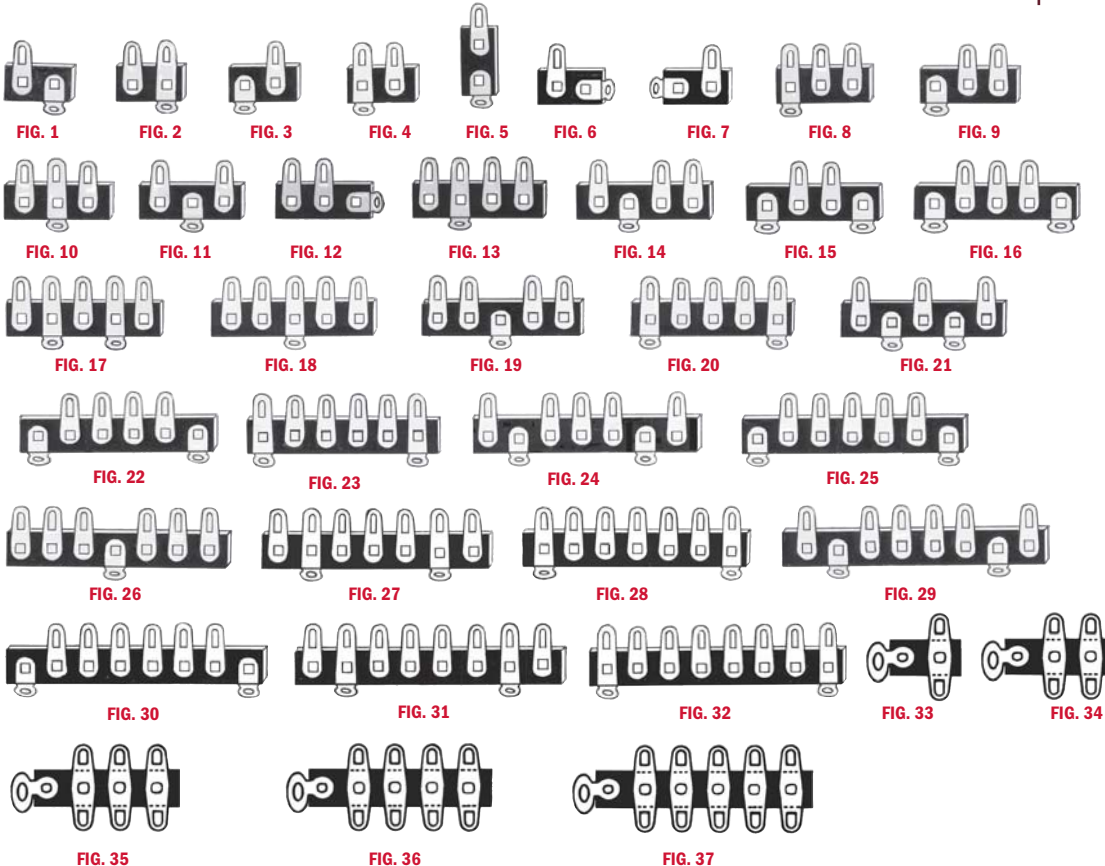
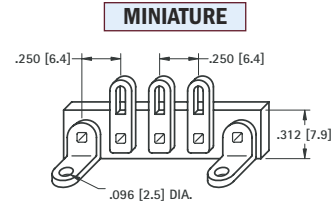
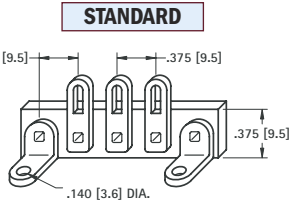

STANDARD CAT. NO.	FIG NO.	MINIATURE CAT. NO.
800	1	837
801	2	838
802	3	839
803	4	840
804	5	841
805	6	842
806	7	843
807	8	844
808	9	845
809	10	846
810	11	847
811	12	848
812	13	849
813	14	850
814	15	851
815	16	852
816	17	853
817	18	854
818	19	855
819	20	856
820	21	857
821	22	858
822	23	859
823	24	860
824	25	861
825	26	862
826	27	863
827	28	864
828	29	865
829	30	866
830	31	867
831	32	—
832	33	—
833	34	—
834	35	—
835	36	—
836	37	—

TERMINAL STRIPS

BINDING POST STRIPS

FIBERGLASS: Reinforced Polyester NEMA Graded GP0-3 rated for 300° F. (155° C).

GEE: Glass, Epoxy, MIL-I-24768/27 Type G-10. Temp. 300° F. (155° C).

PBE: Paper base electrical, FED. LP-513 Type XP natural, Temp 250° F. max. (121° C).

MATERIAL SPECIFICATIONS FOR ALL BINDING POST STRIPS

STANDARD

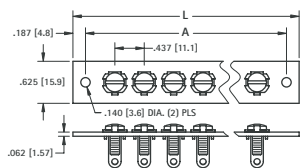

XP PHENOLIC CAT. NO.	GLASS EPOXY CAT. NO.	FIBER-GLASS CAT. NO.	L LENGTH	A MTG. CENTERS	NO. OF TERM
4187	4177	4167	1.250 (31.8)	.875 (22.2)	1
4188	4178	4168	1.687 (42.8)	1.312 (33.3)	2
4189	4179	4169	2.125 (54.0)	1.750 (44.5)	3
4190	4180	4170	2.562 (65.1)	2.187 (55.5)	4
4191	4181	4171	3.000 (76.2)	2.625 (66.7)	5
4192	4182	4172	3.437 (87.3)	3.062 (77.8)	6
4193	4183	4173	3.875 (98.4)	3.500 (88.9)	7
4194	4184	4174	4.312 (109.5)	3.937 (100.0)	8
4195	4185	4175	4.750 (120.7)	4.375 (111.1)	9
4196	4186	4176	5.187 (131.7)	4.812 (122.2)	10

Terminals supplied on these strips



CAT. NO. 1248

HEAVY DUTY

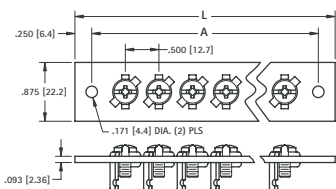

GLASS EPOXY CAT. NO.	FIBER-GLASS CAT. NO.	L LENGTH	A MTG. CENTERS	NO. OF TERM
4147	4157	1.50 (38.1)	1.00 (25.4)	1
4148	4158	2.00 (50.8)	1.50 (38.1)	2
4149	4159	2.50 (63.5)	2.00 (50.8)	3
4150	4160	3.00 (76.2)	2.50 (63.5)	4
4151	4161	3.50 (88.9)	3.00 (76.2)	5
4152	4162	4.00 (101.6)	3.50 (88.9)	6
4153	4163	4.50 (114.3)	4.00 (101.6)	7
4154	4164	5.00 (127.0)	4.50 (114.3)	8
4155	4165	5.50 (139.7)	5.00 (127.0)	9
4156	4166	6.00 (152.4)	5.50 (139.7)	10

Terminals supplied on these strips



CAT. NO. 1209

CONVERSION CHART

MILLIMETERS • DECIMALS • FRACTIONS

MM	Decimals	Fractions	MM	Decimals	Fractions	MM	Decimals	Fractions	MM	Decimals	Fractions	MM	Decimals	Fractions
0.1	.0039		5.2	.2047		10.319	.4063	13/32	15.5	.6102		20.638	.8125	13/16
0.2	.0079		5.3	.2087		10.4	.4094		15.6	.6142		20.7	.8150	
0.3	.0118		5.4	.2126		10.5	.4134		15.7	.6181		20.8	.8189	
0.397	.0156	1/64	5.5	.2165		10.6	.4173		15.8	.6220		20.9	.8228	
0.4	.0157		5.556	.2188	7/32	10.7	.4213		15.875	.6250	5/8	21.0	.8268	
0.5	.0197		5.6	.2205		10.716	.4219	27/64	15.9	.6260		21.034	.8281	53/64
0.6	.0236		5.7	.2244		10.8	.4252		16.0	.6299		21.1	.8307	
0.7	.0276		5.8	.2283		10.9	.4291		16.1	.6339		21.2	.8346	
0.794	.0313	1/32	5.9	.2323		11.0	.4331		16.2	.6378		21.3	.8386	
0.8	.0315		5.953	.2344	15/64	11.1	.4370		16.272	.6406	41/64	21.4	.8425	
0.9	.0354		6.0	.2362		11.113	.4375	7/16	16.3	.6417		21.431	.8438	27/32
1.0	.0394		6.1	.2402		11.2	.4409		16.4	.6457		21.5	.8465	
1.1	.0433		6.2	.2441		11.3	.4449		16.5	.6496		21.6	.8504	
1.191	.0469	3/64	6.3	.2480		11.4	.4488		16.6	.6535		21.7	.8543	
1.2	.0472		6.350	.2500	1/4	11.5	.4528		16.669	.6563	21/32	21.8	.8583	
1.3	.0512		6.4	.2520		11.509	.4531	29/64	16.7	.6575		21.828	.8594	55/64
1.4	.0551		6.5	.2559		11.6	.4567		16.8	.6614		21.9	.8622	
1.5	.0591		6.6	.2598		11.7	.4606		16.9	.6654		22.0	.8661	
1.588	.0625	1/16	6.7	.2638		11.8	.4646		17.0	.6693		22.1	.8701	
1.6	.0630		6.747	.2656	17/64	11.9	.4685		17.066	.6719	43/64	22.2	.8740	
1.7	.0669		6.8	.2677		11.906	.4688	15/32	17.1	.6732		22.225	.8750	7/8
1.8	.0709		6.9	.2717		12.0	.4724		17.2	.6772		22.3	.8780	
1.9	.0748		7.0	.2756		12.1	.4764		17.3	.6811		22.4	.8819	
1.984	.0781	5/64	7.1	.2795		12.2	.4803		17.4	.6850		22.5	.8858	
2.0	.0787		7.144	.2813	9/32	12.3	.4843		17.463	.6875	11/16	22.6	.8898	
2.1	.0827		7.2	.2835		12.303	.4844	31/64	17.5	.6890		22.622	.8906	57/64
2.2	.0866		7.3	.2874		12.4	.4882		17.6	.6929		22.7	.8937	
2.3	.0906		7.4	.2913		12.5	.4921		17.7	.6968		22.8	.8976	
2.381	.0938	3/32	7.5	.2953		12.6	.4961		17.8	.7008		22.9	.9016	
2.4	.0945		7.541	.2969	19/64	12.700	.5000	1/2	17.859	.7031	45/64	23.0	.9055	
2.5	.0984		7.6	.2992		12.8	.5039		17.9	.7047		23.019	.9063	29/32
2.6	.1024		7.7	.3031		12.9	.5079		18.0	.7087		23.1	.9094	
2.7	.1063		7.8	.3071		13.0	.5118		18.1	.7126		23.2	.9134	
2.778	.1094	7/64	7.9	.3110		13.097	.5156	33/64	18.2	.7165		23.3	.9173	
2.8	.1102		7.938	.3125	5/16	13.1	.5157		18.256	.7188	23/32	23.4	.9213	
2.9	.1142		8.0	.3150		13.2	.5197		18.3	.7205		23.416	.9219	59/64
3.0	.1181		8.1	.3189		13.3	.5236		18.4	.7244		23.5	.9252	
3.1	.1220		8.2	.3228		13.4	.5276		18.5	.7283		23.6	.9291	
3.175	.1250	1/8	8.3	.3268		13.494	.5313	17/32	18.6	.7323		23.7	.9331	
3.2	.1260		8.334	.3281	21/64	13.5	.5315		18.653	.7344	47/64	23.8	.9370	
3.3	.1299		8.4	.3307		13.6	.5354		18.7	.7362		23.813	.9375	15/16
3.4	.1339		8.5	.3346		13.7	.5394		18.8	.7402		23.9	.9409	
3.5	.1378		8.6	.3386		13.8	.5433		18.9	.7441		24.0	.9449	
3.572	.1406	9/64	8.7	.3425		13.891	.5469	35/64	19.0	.7480		24.1	.9488	
3.6	.1417		8.731	.3438	11/32	13.9	.5472		19.050	.7500	3/4	24.2	.9528	
3.7	.1457		8.8	.3465		14.0	.5512		19.1	.7520		24.209	.9531	61/64
3.8	.1496		8.9	.3504		14.1	.5551		19.2	.7559		24.3	.9567	
3.9	.1535		9.0	.3543		14.2	.5591		19.3	.7598		24.4	.9606	
3.969	.1563	5/32	9.1	.3583		14.288	.5625	9/16	19.4	.7638		24.5	.9646	
4.0	.1575		9.128	.3594	23/64	14.3	.5630		19.447	.7656	49/64	24.6	.9685	
4.1	.1614		9.2	.3622		14.4	.5669		19.5	.7677		24.606	.9688	31/32
4.2	.1654		9.3	.3661		14.5	.5709		19.6	.7717		24.7	.9724	
4.3	.1693		9.4	.3701		14.6	.5748		19.7	.7756		24.8	.9764	
4.366	.1719	11/64	9.5	.3740		14.684	.5781	37/64	19.8	.7795		24.9	.9803	
4.4	.1732		9.525	.3750	3/8	14.7	.5787		19.844	.7813	25/32	25.0	.9843	
4.5	.1772		9.6	.3780		14.8	.5827		19.9	.7835		25.003	.9844	63/64
4.6	.1811		9.7	.3819		14.9	.5866		20.0	.7874		25.1	.9882	
4.7	.1850		9.8	.3858		15.0	.5906		20.1	.7913		25.2	.9921	
4.763	.1875	3/16	9.9	.3898		15.081	.5938	19/32	20.2	.7953		25.3	.9961	
4.8	.1890		9.922	.3906	25/64	15.1	.5945		20.241	.7969	51/64	25.400	1.0000	1
4.9	.1929		10.0	.3937		15.2	.5984		20.3	.7992				
5.0	.1969		10.1	.3976		15.3	.6024		20.4	.8031				
5.1	.2008		10.2	.4016		15.4	.6063		20.5	.8071				
5.159	.2031	13/64	10.3	.4055		15.478	.6094	39/64	20.6	.8110				

KEYSTONE
ELECTRONICS CORP.
www.keyelco.com

PC Hardware • Coin Cell Holders & Retainers • Plugs & Jacks • Battery Clips & Holders • Computer Brackets & Hardware • Fuse Clips & Holders
Terminals & Lugs • Spacers & Standoffs • Panel & Insulating Hardware • Micro Pins & Jacks • Tape & Reel SMT Products
Test Points • Audio Jacks • Auto Fuse Clips • USB and IEEE 1394 Plugs & Sockets

Tel (718) 956-8900 • Fax (718) 956-9040
(800) 221-5510 • kec@keyelco.com

KEYSTONE
ELECTRONICS CORP.
RoHS COMPLIANT — ISO 9001 CERTIFIED

www.keyelco.com
31-07 20th Road - Astoria, NY 11105-2017

DRILL SIZE DIAMETER TABLE

Diameter	Drill Size	Diameter	Drill Size	Diameter	Drill Size	Diameter	Drill Size
.0135	80	.0935	42	.2031	13/64	.4040	Y
.0145	79	.0938	3/32	.2040	6	.4062	13/32
.0156	1/64	.0960	41	.2055	5	.4130	Z
.0160	78	.0980	40	.2090	4	.4219	27/64
.0180	77	.0995	39	.2130	3	.4375	7/16
.0200	76	.1015	38	.2188	7/32	.4531	29/64
.0210	75	.1040	37	.2210	2	.4688	15/32
.0225	74	.1065	36	.2280	1	.4844	31/64
.0240	73	.1094	7/64	.2340	A	.5000	1/2
.0250	72	.1100	35	.2344	15/64	.5156	33/64
.0260	71	.1110	34	.2380	B	.5312	17/32
.0280	70	.1130	33	.2420	C	.5469	35/64
.0292	69	.1160	32	.2460	D	.5625	9/16
.0310	68	.1200	31	.2500	1/4	.5781	37/64
.0312	1/32	.1250	1/8	.2500	E	.5938	19/32
.0320	67	.1285	30	.2570	F	.6094	39/64
.0330	66	.1360	29	.2610	G	.6250	5/8
.0350	65	.1405	28	.2656	17/64	.6406	41/64
.0360	64	.1406	9/64	.2660	H	.6562	21/32
.0370	63	.1440	27	.2720	I	.6719	43/64
.0380	62	.1470	26	.2770	J	.6875	11/16
.0390	61	.1495	25	.2810	K	.7031	45/64
.0400	60	.1520	24	.2812	9/32	.7188	23/32
.0410	59	.1540	23	.2900	L	.7344	47/64
.0420	58	.1562	5/32	.2950	M	.7500	3/4
.0430	57	.1570	22	.2969	19/64	.7656	49/64
.0465	56	.1590	21	.3020	N	.7812	25/32
.0469	3/64	.1610	20	.3125	5/16	.7969	51/64
.0520	55	.1660	19	.3160	O	.8120	13/16
.0550	54	.1695	18	.3230	P	.8281	53/64
.0595	53	.1719	11/64	.3281	21/64	.8438	27/32
.0625	1/16	.1730	17	.3320	Q	.8594	55/64
.0635	52	.1770	16	.3390	R	.8750	7/8
.0670	51	.1800	15	.3438	11/32	.8906	57/64
.0700	50	.1820	14	.3480	S	.9062	29/32
.0730	49	.1850	13	.3580	T	.9219	59/64
.0760	48	.1875	3/16	.3594	23/64	.9375	15/16
.0781	5/64	.1890	12	.3680	U	.9531	61/64
.0785	47	.1910	11	.3750	3/8	.9688	31/32
.0810	46	.1935	10	.3770	V	.9844	63/64
.0820	45	.1960	9	.3860	W	1.0000	1/1
.0860	44	.1990	8	.3906	25/64		
.0890	43	.2010	7	.3970	X		

SCREW/STUD CLEARANCE HOLE TABLE

Screw/Stud Size	Screw/Stud Dia. Max.	Recommended Clearance Hole Dia.
0	.060	.067
1	.073	.078
2	.086	.093
3	.099	.105
4	.112	.120
5	.125	.130
6	.138	.144
8	.164	.169
10	.190	.196
12	.216	.220
14	.242	.250
1/4	.250	.257

Keystone's quality system is certified to ISO 9001:2000 by DNV Certification, Inc. under the RAB and RvA accreditations. Our Quality Assurance Program is in accordance with these requirements and applies to all standard and custom interconnect components and electronic hardware.

It is Keystone's Quality Policy to continuously improve its products to better satisfy the needs of its customers and to deliver quality products, every time and on time.

QUALITY ASSURANCE

- Baty Gage Master Comparator
- Thread, Plug and Ring Gauges
- Granite Surface Plates
- Dial Indicators
- Plating Thickness Tester
- Ames Precision Hardness Tester
- Gauge Blocks and Pin Gauges
- Micrometers and Verniers
- Depth and Height Gauges
- ISO 9001:2008 Certified



**DNV BUSINESS ASSURANCE
MANAGEMENT SYSTEM CERTIFICATE**

Certificate No. CERT-8053-2004-AQ-HOU-ANAB

This is to certify that

Keystone Electronics Corporation

at

31-07 20th Road, Astoria, NY 11105 USA

Additional Location:

Site Name	Site Address	Site City, State, Zip	Site Main Activities
Keystone Electronics Corporation	19-36 38th Street	Astoria, NY 11105 USA	Stamping Operation

has been found to conform to the Management System Standard:

ISO 9001:2008

This Certificate is valid for the following product or service ranges:

The manufacture of interconnect components and hardware.

Initial Certification date:

February 18, 1996

Place and date:

Houston, Texas, March 09, 2013

This Certificate is valid until:

March 09, 2016

for the Accredited Unit:
DET NORSKE VERITAS
CERTIFICATION INC., HOUSTON TEXAS

The audit has been performed under the supervision of

Anthony V Como
Lead Auditor



John Stefan
John Stefan
Management Representative

Lack of fulfillment of conditions as set out in the Certification Agreement may render this Certificate invalid.

ACCREDITED UNIT: DET NORSKE VERITAS CERTIFIKASJON, INC 1400 RAVELLO DRIVE, 77449, KATY, TX, USA, TEL: 281-396-1000, WWW.DNVCERT.COM

NUMERICAL INDEX

CAT. NO.	14 – 573	PAGE NO.	CAT. NO.	574 – 1027	PAGE NO.	CAT. NO.	1028 – 1421	PAGE NO.
14 thru 48		134	574		102	1028		18
50		8	575		107	1028C		18
51 thru 52		9	576		102	1029		18
53		8	577		103	1029C		18
54		9	580 thru 583		102	1029LC		18
55 thru 57		8	584 thru 589		103	1030 thru 1041		59
58 thru 60		10	590 thru 591		9	1042 thru 1043		17
61 thru 66		11	593 thru 594		30	1045 thru 1046		59
68		29	595 thru 597		9	1048 thru 1049		17
69 thru 71		11	598 thru 599		102	1050 thru 1051		20
72		29	603 thru 609		142	1052 thru 1053		5
78 thru 80		11	611 thru 612		114	1056		2
81		28	613		115	1059 thru 1064		4
82		9	614		114	1065 thru 1067		3
83		29	615		115	1068		5
84		28	616 thru 617		114	1069		2
85		29	618 thru 620		115	1071 thru 1073		5
86 thru 89		10	621		114	1081 thru 1082		4
90 thru 91		11	628 thru 629		9	1083 thru 1091		5
92		9	630		115	1093 thru 1094		4
93 thru 95		11	631 thru 632		114	1103		20
96		29	633		115	1139 thru 1199		24
97 thru 98		11	634		114	1200		123
99 thru 100		10	635 thru 636		30	1201 thru 1209		66
101 thru 103		3	637		9	1210		123
104 thru 105		5	652 thru 659		106	1211 thru 1213		52
106		3	680		58	1215		67
107		5	700 thru 705		85	1216		52
108		18	708		114	1217		67
108-2		13	715 thru 716		85	1218 thru 1219		101
108C		18	717 thru 729		130	1220 thru 1222		54
109-2		13	730 thru 778		129	1223 thru 1226		123
109-3		13	779		74	1227 thru 1229		54
131 thru 132		20	780 thru 785		130	1230 thru 1231		123
137 thru 140		22	789 thru 799		74	1232		67
146 thru 153		21	800 thru 868		143	1233 thru 1235		54
154 thru 156		22	875 thru 898		74	1236 thru 1238		123
158		21	900 thru 902		103	1240 thru 1242		54
169 thru 201		22	903 thru 910		58	1247 thru 1248		67
202		12	911		102	1249 thru 1250		59
203-P		31	913 thru 918		58	1251		67
204		12	920 thru 923		94	1252		56
205		22	924		95	1254		142
206 thru 208		10	925		94	1256 thru 1263		54
209 thru 210		12	926		95	1264		56
211		10	927 thru 930		97	1265 thru 1266		53
217 thru 222		11	931 thru 932		94	1267		52
223 thru 224		20	933 thru 935		95	1269 thru 1271		54
227		29	936 thru 938		103	1272 thru 1273		67
228		12	940 thru 941		95	1280		54
230-1		13	945 thru 957		96	1281 thru 1282		53
232 thru 237		28	967 thru 968		29	1283 thru 1284		66
238		12	970 thru 973		102	1285 thru 1286		52
261 thru 272		30	1005 thru 1008		54	1287		53
288 thru 296		12	1010 thru 1011		20	1288		52
301		5	1012		19	1289		53
303-P		31	1012C		19	1290 thru 1291		31
330 thru 338		75	1013 thru 1015		18	1292		53
340 thru 344		132	1016		19	1293		66
345 thru 349		131	1017		18	1294 thru 1295		31
351 thru 359		75	1017-1		13	1298 thru 1299		66
361 thru 375		74	1018		19	1300 thru 1326		135
376 thru 396		71	1018C		19	1345		57
397 thru 438		74	1019		18	1352 thru 1365		101
450 thru 452		107	1020		19	1366 thru 1369		100
453 thru 459		74	1020C		19	1370 thru 1371		101
468 thru 471		71	1021		18	1372 thru 1373		100
476		107	1021-1		13	1375 thru 1377		101
480 thru 496		87	1022		19	1378 thru 1379		100
498 thru 504		2	1022C		19	1380 thru 1400		101
510 thru 526		87	1023		18	1401		100
540 thru 548		86	1024		19	1402		101
550		8	1024C		19	1404		100
552		106	1025		5	1405		101
553 thru 557		8	1025-7		5	1406 thru 1408		100
561 thru 567		102	1026		3	1411 thru 1420		98
571 thru 573		103	1027		5	1421		100

CAT. NO.	1422 – 1626	PAGE NO.	CAT. NO.	1627 – 3373	PAGE NO.	CAT. NO.	3381 – 4628	PAGE NO.
1422		101	1627 thru 1630		73	3381 thru 3391		134
1424		100	1633		139	3402 thru 3438		74
1425		101	1635 thru 1639		71	3440 thru 3450		134
1426 thru 1428		100	1640 thru 1641		99	3457 thru 3477		74
1430		101	1642 thru 1643		71	3478 thru 3500		71
1431 thru 1432		98	1644 thru 1646		70	3501 thru 3509		99
1434		99	1650 thru 1655		73	3510 thru 3511		45
1435 thru 1436		98	1656 thru 1657		71	3512		44
1437 thru 1438		99	1658 thru 1659		98	3513 thru 3516		45
1439		98	1662 thru 1672		74	3517 thru 3521		44
1441 thru 1447		101	1673 thru 1689		99	3522		39
1448 thru 1449		84	1692		71	3523		42
1450 thru 1451		71	1693 thru 1699		98	3525		55
1453		84	1700 thru 1706		84	3526 thru 3527		42
1454		74	1707		135	3528		55
1455		101	1708 thru 1710		83	3529 thru 3533		45
1456		84	1713 thru 1726		135	3534		55
1457		74	1731 thru 1796		73	3535		45
1458 thru 1459		84	1797 thru 1904		71	3536 thru 3543		43
1460 thru 1463		101	1909 thru 1920		74	3544		40
1464 thru 1467		84	1921 thru 1923		71	3545 thru 3548		55
1468 thru 1471		98	1924 thru 1925		74	3549		40
1472		84	1927 thru 1933		76	3550		39
1473		99	1934 thru 1942		74	3551		55
1474 thru 1475		71	1944 thru 1966		70	3552 thru 3554		43
1476		109	1967 thru 2001		100	3555		38
1476		131	2002 thru 2005		54	3556		43
1477		109	2025 thru 2031		71	3557		39
1477		131	2032 thru 2036		74	3558 thru 3560		38
1478		98	2037 thru 2053		85	3561 thru 3562		44
1479		99	2060 thru 2073		82	3563 thru 3564		40
1480 thru 1484		74	2087 thru 2099		70	3565 thru 3566		44
1485		131	2103		20	3567		45
1486		99	2119 thru 2131		70	3568		40
1487		101	2139 thru 2140		24	3569		41
1488		99	2149 thru 2161		70	3570		45
1490 thru 1494		74	2162 thru 2176		24	3571 thru 3572		55
1495		123	2180 thru 2181		70	3573		39
1496 thru 1497		99	2182 thru 2199		24	3574		43
1498 thru 1500		123	2201 thru 2221		71	3574C		43
1502 thru 1503		138	2222 thru 2233		21	3575		55
1507		139	2238 thru 2243		28	3576		43
1508		138	2244 thru 2253		131	3576C		43
1509 thru 1511		139	2260 thru 2274		73	3577 thru 3578		55
1514		138	2284 thru 2293		131	3586 thru 3588		41
1515 thru 1519		139	2314		74	3590 thru 3592		98
1520		138	2341 thru 2398		75	3593 thru 3595		99
1525 thru 1526		139	2400 thru 2420		83	3621 thru 3622		44
1527 thru 1532		138	2421 thru 2455		84	4000 thru 4004		58
1533		139	2460 thru 2473		26	4005		54
1535 thru 1537		67	2474 thru 2476		27	4056 thru 4060		142
1540 thru 1545		139	2477 thru 2482		26	4091 thru 4094		108
1546		73	2484		27	4095		54
1547 thru 1548		71	2485 thru 2486		26	4096 thru 4109		108
1556		115	2487 thru 2490		27	4116 thru 4120		142
1557 thru 1559		139	2500 thru 2508		83	4147 thru 4196		143
1560 thru 1561		73	2915		9	4198 thru 4199		108
1562		139	2981 thru 2983		7	4245		42
1563		138	2988 thru 2989		6	4245C		43
1564 thru 1571		115	2990 thru 2993		7	4246 thru 4247		45
1572 thru 1573		138	2994 thru 2999		6	4250		42
1575 thru 1583		139	3000 thru 3013		7	4258 thru 4269		74
1587		138	3020 thru 3025		4	4325 thru 4326		115
1589 thru 1591		73	3026 thru 3029		7	4332 thru 4334		114
1592		139	3030 thru 3031		6	4335 thru 4337		115
1593 thru 1595		138	3032 thru 3044		7	4341 thru 4343		132
1596		73	3049		132	4401 thru 4405		142
1598		138	3050		6	4469 thru 4474		56
1601		104	3051 thru 3069		132	4513 thru 4516		111
1603		98	3070 thru 3074		4	4525 thru 4527		42
1604 thru 1605		73	3075 thru 3077		134	4527C		42
1606 thru 1607		98	3078 thru 3092		7	4590 thru 4600		110
1608 thru 1612		73	3096 thru 3098		6	4601 thru 4609		111
1613		139	3101 thru 3110		132	4616 thru 4617		110
1614 thru 1619		98	3111 thru 3228		131	4618 thru 4620		111
1620 thru 1625		73	3229 thru 3241		132	4626		110
1626		98	3347 thru 3373		131	4628		42

NUMERICAL INDEX

CAT. NO.	4628C – 7689	PAGE NO.	CAT. NO.	7690 – 9200-17	PAGE NO.	CAT. NO.	9200-19 – TL-22	PAGE NO.
4628C		42	7690 thru 7693		62	9200-19		120
4632 thru 4634		110	7690-SEMS thru 7693-SEMS		64	9201-1 thru 9204-1		121
4636 thru 4683		109	7695 thru 7696		65	9207-1 thru 9231-1		120
4684		111	7697		63	9300 thru 9357		133
4687 thru 4689		132	7697-SEMS		64	9400 thru 9457		133
4690		109	7698		65	9500 thru 9581		133
4691 thru 4693		131	7699		63	9600 thru 9604		132
4694		132	7699-SEMS		64	9605 thru 9608		133
4696		109	7700 thru 7702		62	9900 thru 9911		87
4698		132	7700-SEMS thru 7702-SEMS		64	9920		64
4699 thru 4700		131	7710 thru 7720		74	11001 thru 11016		105
4701 thru 4702		132	7760 thru 7772		65	11065 thru 11076		136
4703		131	7773 thru 7774		62	11100 thru 11116		137
4704		58	7775		63	11150 thru 11160		136
4704		109	7778		63	11216 thru 11218		136
4705		132	7778-SEMS		64	11250 thru 11251		136
4706		111	7779 thru 7783		62	11300 thru 11312		136
4707 thru 4711		132	7784 thru 7791		63	11320 thru 11322		136
4712		109	7792 thru 7800		65	11350 thru 11362		137
4713 thru 4716		132	7802 thru 7806		54	11362-5		131
4724 thru 4730		109	7807 thru 7808		65	11363 thru 11513		137
4732 thru 4734		111	7812 thru 7836		54	15021 thru 15099		140
4799 thru 4841		70	8090 thru 8096		127	15101 thru 15130		142
4850 thru 4870		73	8100 thru 8173		126	15221 thru 15299		140
4900		52	8174		63	15301 thru 15330		142
4901 thru 4902		53	8189 thru 8195		62	15401 thru 15545		141
4903 thru 4907		52	8196 thru 8199		63	24283 thru 24306		72
4908		53	8189-SEMS thru 8199-SEMS		64	24307 thru 24330		72
4909		52	8200 thru 8271		57	24331 thru 24354		72
4910 thru 4914		53	8272 thru 8300		56	24380 thru 24418		72
4915 thru 4920		52	8309 thru 8310		90	24420 thru 24458		72
4950 thru 4954		59	8311 thru 8342		91	24460 thru 24498		71
4966		53	8351 thru 8356		86	25501 thru 25515		72
5000 thru 5014		60	8400 thru 8440		70	25521 thru 25535		72
5015 thru 5019		61	8440A thru 8440G		71	29301 thru 29328		72
5020 thru 5026		60	8441 thru 8442		71	29331 thru 29358		72
5029		61	8443 thru 8446		88	CBH		79
5033 thru 5048		61	8447 thru 8457		89	MS27249-1B1 thru -5B5		141
5058 thru 5065		73	8470 thru 8486		128	MS27249-1E1 thru 5E5		141
5070 thru 5083		123	8487 thru 8489		88	PC104		70
5115 thru 5129		60	8490 thru 8496		128	SCR		79
5201		15	8497 thru 8499		88	SPR		79
5202 thru 5204		14	8554 thru 8569		85	STH		79
5205 thru 5209		13	8600 thru 8613		128	STR		79
5210 thru 5212		15	8615 thru 8617		129	TL-1 thru TL-2		138
5213 thru 5214		14	8620 thru 8644		116	TL-3 thru TL-4		139
5217 thru 5223		15	8645 thru 8649		117	TL-5 thru TL-8		138
5224 thru 5228		14	8650 thru 8692		90	TL-9		139
5230 thru 5231		8	8700 thru 8711		83	TL-11		123
5240 thru 5253		16	8712 thru 8729		70	TL-12		139
5330 thru 5331		8	8730		66	TL-19 thru TL-22		73
5799		70	8731 thru 8733		70			
6000 thru 6035		104	8737		66			
6036 thru 6071		105	8799		70			
6072 thru 6075		106	8800 thru 8821		76			
6076 thru 6077		107	8822 thru 8828		78			
6078 thru 6085		106	8829 thru 8842		77			
6090 thru 6096		107	8843 thru 8851		72			
6097		104	8860 thru 8870		127			
6799		70	8871 thru 8875		76			
7004 thru 7024		108	8879 thru 8893		77			
7030 thru 7061		91	8900 thru 8931		91			
7140 thru 7181		87	9018 thru 9054		77			
7186 thru 7188		86	9055 thru 9084		78			
7192 thru 7194		87	9090		133			
7196		86	9100 thru 9123		87			
7200 thru 7225		70	9190 thru 9191		133			
7228 thru 7235		82	9200 thru 9204		118			
7235-1 thru 7235-2		131	9205 thru 9231		119			
7236 thru 7299		82	9200-1 thru 9200-5		120			
7311 thru 7340		58	9200-6 thru 9200-10		121			
7351 thru 7382		91	9200-11		120			
7600 thru 7611		128	9200-12 thru 900-13		121			
7620 thru 7640		127	9200-14		120			
7661 thru 7678		74	9200-15		121			
7680 thru 7688		132	9200-16		120			
7689		65	9200-17		121			

ABOUT KEYSTONE



For over sixty years, Keystone has been designing and manufacturing quality interconnects and electronic hardware. Our engineering and design specialists utilize the most advanced design and production capabilities such as 3D CAD modeling to develop innovative and reliable products for the marketplace. Add to this a commitment to solving design challenges, backed by skilled and experienced production and customer service teams.

Precision tool and die CAD/CAM capabilities, close tolerance stamping, machining and assembly, computer based quality control and responsive customer service are all vital in-house resources which constitute Keystone's capabilities.

While our catalog products meet most standard requirements, our Application Engineering Group is always available to modify our existing items or to design and develop specific products for your applications.

Our products are in compliance with the RoHS and REACH directives and our quality system is ISO 9001:2008 certified. It is Keystone's quality policy to continuously improve its products to better satisfy the needs of its customers and to deliver quality products, every time, on time.

Visit our website at www.keyelco.com for additional information and on-line services, such as:

- Stock Check Capabilities
- Engineering Drawing requests
- Sample and Quotation requests
- Complete listing of our Authorized Stocking Distributors worldwide



All products unconditionally guaranteed against defects in material and workmanship.

Keystone components are guaranteed to be free from defects in material and workmanship for a reasonable period of time after delivery. Our liability shall be limited to replacement of defective material only. Neither seller or manufacturer shall be liable for any injury, loss or damage, direct or consequential, arising out of the use of or the inability to use the products. Before using, user shall determine the suitability of the product for their intended use, user assumes all risk and liability whatsoever in connection therewith. We reserve the right to change specifications on any and all items shown in this catalog or any

supplements without prior notice providing the performance or appearance will not change the function of the item.

Keystone has carefully prepared the catalog specifications contained herein. These specifications are for reference only, any inaccuracies may be due to typographical errors or changes made after the publication of this catalog.

© Copyright 2013 by Keystone Electronics Corp. Printed in U.S.A.

FEDERAL SUPPLY CODE
FSCM
91833

DISTRIBUTED BY:

KEYSTONE[®]

ELECTRONICS CORP.

Corporate and Manufacturing Headquarters

31-07 20th Road, Astoria, New York 11105-2017

Tel: (718) 956-8900 • (800) 221-5510 • Fax: (718) 956-9040

Website: www.keyelco.com • e-mail: kec@keyelco.com

INTERNATIONAL OFFICES

KEYSTONE/EUROPE (EMEA)

80, Rue Orfila,
75020 Paris, France
Tel: 33 (1) 46 36 82 49
Fax: 33 (1) 46 36 81 57

KEYSTONE/CANADA

250 Granton Drive
Richmond Hill, Ontario
Canada L4B1H7
Tel: (905) 764-0040
Fax: (905) 764-0076

KEYSTONE/ASIA – PACIFIC

Flat E, 5/F, Everest Industrial Centre
No.396 Kwun Tong Road,
Kowloon, Hong Kong
Tel: +852 2305 2229
Fax: +852 2305 2666

KEYSTONE/AUSTRALIA

10 Gray Street
Kilkenny, South Australia 5009
Tel: 61-8-8268-2733
Fax: 61-8-8268-1455

www.keyelco.com

There's a keystone in every great invention ... Follow, THiNK & Learn at:



Компания «Life Electronics» занимается поставками электронных компонентов импортного и отечественного производства от производителей и со складов крупных дистрибьюторов Европы, Америки и Азии.

С конца 2013 года компания активно расширяет линейку поставок компонентов по направлению коаксиальный кабель, кварцевые генераторы и конденсаторы (керамические, пленочные, электролитические), за счёт заключения дистрибьюторских договоров

Мы предлагаем:

- Конкурентоспособные цены и скидки постоянным клиентам.
- Специальные условия для постоянных клиентов.
- Подбор аналогов.
- Поставку компонентов в любых объемах, удовлетворяющих вашим потребностям.
- Приемлемые сроки поставки, возможна ускоренная поставка.
- Доставку товара в любую точку России и стран СНГ.
- Комплексную поставку.
- Работу по проектам и поставку образцов.
- Формирование склада под заказчика.
- Сертификаты соответствия на поставляемую продукцию (по желанию клиента).
- Тестирование поставляемой продукции.
- Поставку компонентов, требующих военную и космическую приемку.
- Входной контроль качества.
- Наличие сертификата ISO.

В составе нашей компании организован Конструкторский отдел, призванный помогать разработчикам, и инженерам.

Конструкторский отдел помогает осуществить:

- Регистрацию проекта у производителя компонентов.
- Техническую поддержку проекта.
- Защиту от снятия компонента с производства.
- Оценку стоимости проекта по компонентам.
- Изготовление тестовой платы монтаж и пусконаладочные работы.



Тел: +7 (812) 336 43 04 (многоканальный)

Email: org@lifeelectronics.ru