



Features

- Axial/radial leaded
- Fully compatible with current industry standards
- Weldable nickel terminals
- Very low internal resistance
- RoHS compliant*
- Agency recognition:   

Applications

Any application that requires extra protection at elevated ambient temperatures, which the 100 °C trip temperature provides.

- Rechargeable battery pack protection
- Cellular phones
- Laptop computers

MF-LS Series - PTC Resettable Fuses

Electrical Characteristics

Model	V max. Volts	I max. Amps	I _{hold}	I _{trip}	Initial Resistance		1 Hour (R ₁) Post-Trip Resistance	Max. Time to Trip		Tripped Power Dissipation
			Amperes at 23 °C		Ohms at 23 °C		Ohms at 23 °C	Amperes at 23 °C	Seconds at 23 °C	Watts at 23 °C
			Hold	Trip	Min.	Max.	Max.			Typ.
MF-LS100S	24	100	1.0	2.5	0.070	0.130	0.260	5	7.0	1.5
MF-LS180	24	100	1.8	3.8	0.040	0.068	0.120	9	2.9	2.0
MF-LS180L	24	100	1.8	3.8	0.040	0.068	0.120	9	2.9	2.0
MF-LS180S	24	100	1.8	3.8	0.040	0.068	0.120	9	2.9	2.0
MF-LS190	24	100	1.9	4.2	0.030	0.057	0.100	10	3.0	1.9
MF-LS190RU	15	100	1.9	4.2	0.030	0.057	0.100	10	3.0	1.9
MF-LS260	24	100	2.6	5.2	0.025	0.042	0.076	13	5.0	2.3
MF-LS300	24	100	3.0	6.3	0.015	0.031	0.055	15	4.0	2.0
MF-LS340	24	100	3.4	6.8	0.016	0.027	0.050	17	5.0	2.7

NOTE: Slotted option available on all models.

Environmental Characteristics

Operating/Storage Temperature.....	-40 °C to +85 °C
Maximum Device Surface Temperature	
in Tripped State	125 °C
Passive Aging.....	+85 °C, 1000 hours..... ±10 % typical resistance change
Humidity Aging.....	+85 °C, 85% R.H. 7 days..... ±5 % typical resistance change
Vibration	MIL-STD-883C..... No change
	Condition A

Test Procedures And Requirements For Model MF-LS Series

Test	Test Conditions	Accept/Reject Criteria
Visual/Mech.....	Verify dimensions and materials.....	Per MF physical description
Resistance.....	In still air @ 23 °C.....	R _{min} ≤ R ≤ R _{1max}
Time to Trip.....	At specified current, V _{max} , 23 °C.....	T ≤ max. time to trip (seconds)
Hold Current.....	30 min. at I _{hold}	No trip
Trip Cycle Life.....	V _{max} , I _{max} , 100 cycles.....	No arcing or burning
Trip Endurance	V _{max} , 48 hours.....	No arcing or burning

UL File Number	E 174545S
CSA File Number.....	CA 110338
TÜV File Number	R2057213

Thermal Derating Chart - I_{hold}/ I_{trip} (Amps)

Model	Ambient Operating Temperature								
	-40 °C	-20 °C	0 °C	23 °C	40 °C	50 °C	60 °C	70 °C	85 °C
MF-LS100S	1.80 / 4.50	1.60 / 4.00	1.40 / 3.50	1.00 / 2.50	0.80 / 2.00	0.70 / 1.75	0.60 / 1.50	0.40 / 1.00	0.20 / 0.50
MF-LS180	3.10 / 6.54	2.60 / 5.49	2.20 / 4.64	1.80 / 3.80	1.30 / 2.74	1.10 / 2.32	0.90 / 1.90	0.60 / 1.27	0.20 / 0.42
MF-LS180L	3.10 / 6.54	2.60 / 5.49	2.20 / 4.64	1.80 / 3.80	1.30 / 2.74	1.10 / 2.32	0.90 / 1.90	0.60 / 1.27	0.20 / 0.42
MF-LS180S	3.10 / 6.54	2.60 / 5.49	2.20 / 4.64	1.80 / 3.80	1.30 / 2.74	1.10 / 2.32	0.90 / 1.90	0.60 / 1.27	0.20 / 0.42
MF-LS190	3.30 / 7.29	2.80 / 6.19	2.40 / 5.31	1.90 / 4.20	1.40 / 3.09	1.20 / 2.65	1.10 / 2.43	0.70 / 1.55	0.40 / 0.88
MF-LS190RU	3.30 / 7.29	2.80 / 6.19	2.40 / 5.31	1.90 / 4.20	1.40 / 3.09	1.20 / 2.65	1.10 / 2.43	0.70 / 1.55	0.40 / 0.88
MF-LS260	4.30 / 8.60	3.70 / 7.40	3.10 / 6.20	2.60 / 5.20	1.90 / 3.80	1.60 / 3.20	1.40 / 2.80	1.10 / 2.20	0.60 / 1.20
MF-LS300	5.10 / 10.7	4.40 / 9.24	3.70 / 7.77	3.00 / 6.30	2.30 / 4.83	1.90 / 3.99	1.60 / 3.36	1.20 / 2.52	0.60 / 1.26
MF-LS340	5.50 / 11.0	4.70 / 9.40	4.00 / 8.00	3.40 / 6.80	2.60 / 5.20	2.20 / 4.40	1.90 / 3.80	1.50 / 3.00	0.80 / 1.60

*RoHS Directive 2002/95/EC Jan 27, 2003 including Annex. Specifications are subject to change without notice. Customers should verify actual device performance in their specific applications.

MF-LS Series - PTC Resettable Fuses

BOURNS®

Product Dimensions

Model	A		B		C		D		F		Pkg. Style
	Min.	Max.	Min.	Max.	Min.	Max.	Min.	Max.	Min.	Max.	
MF-LS100S	20.9 (0.823)	23.1 (0.909)	4.9 (0.193)	5.2 (0.205)	0.6 (0.024)	1.0 (0.039)	4.1 (0.161)	5.5 (0.217)	3.8 (0.150)	4.1 (0.161)	S
MF-LS180	24.0 (0.945)	26.0 (1.024)	4.9 (0.193)	5.2 (0.205)	0.6 (0.024)	1.0 (0.039)	4.1 (0.161)	5.5 (0.217)	3.8 (0.150)	4.1 (0.161)	Std.
MF-LS180L	35.0 (1.38)	37.5 (1.48)	4.9 (0.193)	5.6 (0.22)	0.6 (0.024)	1.0 (0.039)	9.6 (0.38)	10.0 (0.40)	3.8 (0.150)	4.2 (0.17)	Std.
MF-LS180S	24.0 (0.945)	26.0 (1.024)	4.9 (0.193)	5.2 (0.205)	0.6 (0.024)	1.0 (0.039)	4.1 (0.161)	5.5 (0.217)	3.8 (0.150)	4.1 (0.161)	S
MF-LS190	21.3 (0.839)	23.4 (0.921)	10.2 (0.402)	11.0 (0.433)	0.5 (0.020)	1.1 (0.043)	5.0 (0.197)	7.6 (0.299)	4.8 (0.189)	5.4 (0.213)	Std.
MF-LS190RU	19.8 (0.780)	20.8 (0.819)	13.3 (0.524)	14.3 (0.563)	0.4 (0.016)	0.76 (0.030)	8.1 (0.319)	9.5 (0.374)	3.8 (0.150)	4.1 (0.161)	RU
MF-LS260	24.0 (0.945)	26.0 (1.024)	10.8 (0.425)	11.9 (0.469)	0.6 (0.024)	1.0 (0.039)	5.0 (0.197)	7.0 (0.276)	5.9 (0.232)	6.1 (0.240)	Std.
MF-LS300	28.4 (1.118)	31.8 (1.252)	13.0 (0.512)	13.5 (0.531)	0.5 (0.020)	1.1 (0.043)	6.3 (0.248)	8.9 (0.350)	6.0 (0.236)	6.6 (0.260)	Std.
MF-LS340	24.0 (0.945)	26.0 (1.024)	14.8 (0.583)	15.9 (0.626)	0.6 (0.024)	1.0 (0.039)	4.0 (0.158)	5.0 (0.197)	6.0 (0.236)	6.1 (0.240)	Std.

Packaging: Bulk - 500 pcs. per bag.
Tape and Reel - Consult factory.

NOTE: Longer lead option available. Consult factory.

DIMENSIONS: $\frac{\text{MM}}{\text{(INCHES)}}$

Standard Style

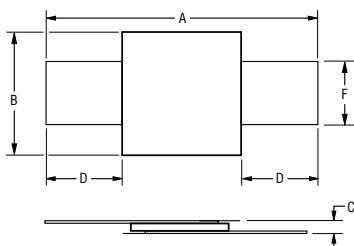

"S" Style

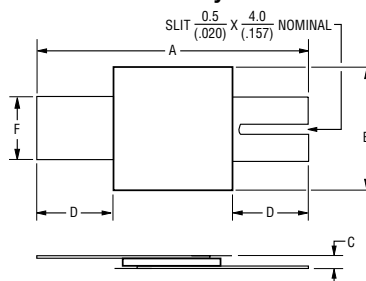

"RU" Style

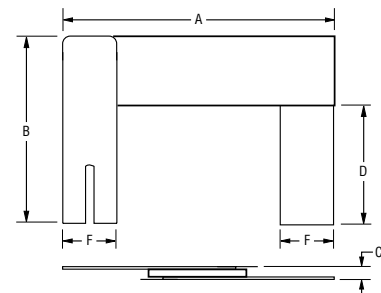

Terminal material: quarter-hard nickel

Typical Part Marking

Represents total content. Layout may vary.

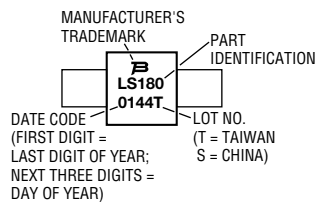

Specifications are subject to change without notice. Customers should verify actual device performance in their specific applications.

MF-LS Series - PTC Resettable Fuses

BOURNS®

Typical Time to Trip at 23 °C

MF-LS models offer trip temperatures lower than MF-S models for extra protection at elevated temperatures.

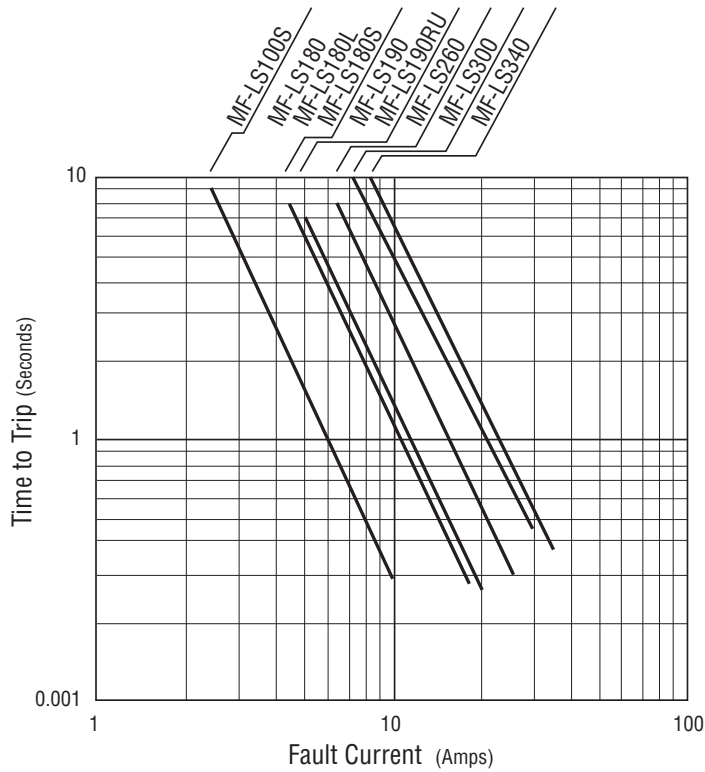

How to Order

MF - LS 100 S -

Multifuse® Product Designator _____

Series _____
 LS = Axial Leaded "Strap" Component

Hold Current, I_{hold} _____
 100-340 (1.0 Amps - 3.40 Amps)

Lead Option _____
 S = Slotted Lead Option
 RU = Radial Lead Option

Packaging Options _____
 - = Bulk Packaging
 - 2 = Tape and Reel*

*Packaged per EIA486-B

Taped Component Dimensions

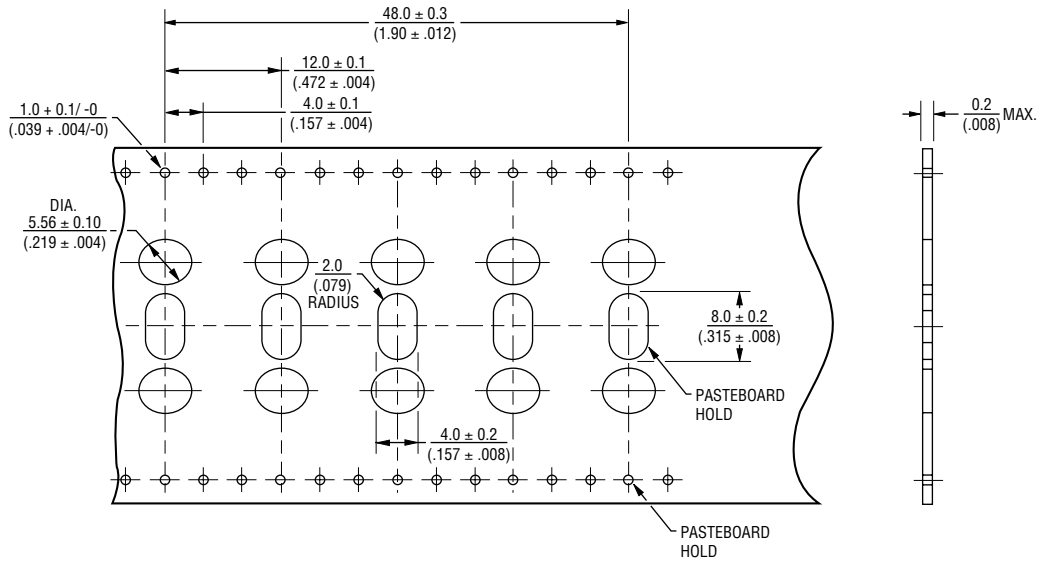

Reel Dimensions



DIMENSIONS: $\frac{\text{MM}}{\text{(INCHES)}}$

Компания «Life Electronics» занимается поставками электронных компонентов импортного и отечественного производства от производителей и со складов крупных дистрибьюторов Европы, Америки и Азии.

С конца 2013 года компания активно расширяет линейку поставок компонентов по направлению коаксиальный кабель, кварцевые генераторы и конденсаторы (керамические, пленочные, электролитические), за счёт заключения дистрибьюторских договоров

Мы предлагаем:

- Конкурентоспособные цены и скидки постоянным клиентам.
- Специальные условия для постоянных клиентов.
- Подбор аналогов.
- Поставку компонентов в любых объемах, удовлетворяющих вашим потребностям.
- Приемлемые сроки поставки, возможна ускоренная поставка.
- Доставку товара в любую точку России и стран СНГ.
- Комплексную поставку.
- Работу по проектам и поставку образцов.
- Формирование склада под заказчика.
- Сертификаты соответствия на поставляемую продукцию (по желанию клиента).
- Тестирование поставляемой продукции.
- Поставку компонентов, требующих военную и космическую приемку.
- Входной контроль качества.
- Наличие сертификата ISO.

В составе нашей компании организован Конструкторский отдел, призванный помогать разработчикам, и инженерам.

Конструкторский отдел помогает осуществить:

- Регистрацию проекта у производителя компонентов.
- Техническую поддержку проекта.
- Защиту от снятия компонента с производства.
- Оценку стоимости проекта по компонентам.
- Изготовление тестовой платы монтаж и пусконаладочные работы.



Тел: +7 (812) 336 43 04 (многоканальный)

Email: org@lifeelectronics.ru