

Distinctive Characteristics

Top or side actuation permits flexible board design.

Bright, LED illumination at tip of actuator.

Compact dimensions and low profile allow high density mounting and close stacking of PC boards.

Crisp actuation positively indicates circuit status.

Double molded thermoset base and thermoplastic housing prevent loosening of terminals due to high soldering temperatures.

Sliding twin contact mechanism with self-cleaning action provides smooth actuation and produces high contact reliability.

Insert molded terminals lock out flux, solvents, and other contaminants.

Inch terminal spacing for standard PC board grid (.100" x .100").

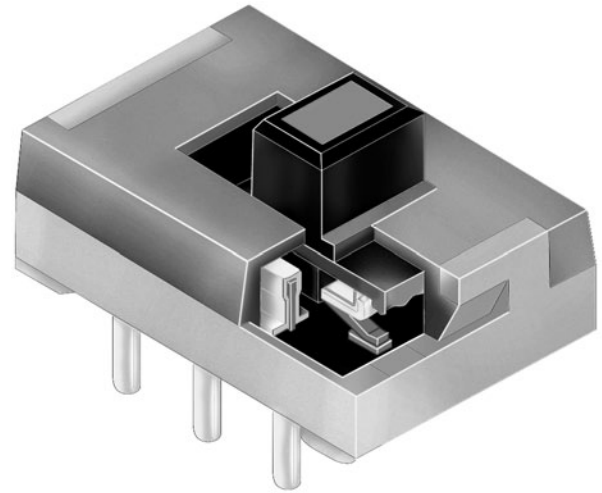

Actual Size



General Specifications

Electrical Capacity (Resistive Load)

Power Level: 0.1A @ 30V DC

Other Ratings

| | |
|-------------------------------|----------------------------------|
| Contact Resistance: | 20 milliohms maximum |
| Insulation Resistance: | 100 megohms minimum @ 500V DC |
| Dielectric Strength: | 500V AC minimum 1 minute minimum |
| Mechanical Life: | 10,000 operations minimum |
| Electrical Life: | 10,000 operations minimum |
| Contact Timing: | Shorting (make-before-break) |
| Total Travel: | .079" (2.0mm) |

Materials & Finishes

| | |
|---------------------------|---|
| Actuator: | Polyacetal |
| Upper Case: | Polyacetal |
| Lower Case: | Glass fiber reinforced polyester |
| Movable Contactor: | Phosphor bronze with silver plating |
| Interior Base: | Phenolic resin (thermoset) |
| Terminals: | Brass with silver plating over copper plating |

Environmental Data

| | |
|------------------------------|--|
| Operating Temp Range: | -15°C through +60°C (+5°F through +140°F) |
| Humidity: | 90 ~ 95% humidity for 96 hours @ 40°C (104°F) |
| Vibration: | 10 ~ 55Hz with peak-to-peak amplitude of 1.5mm traversing the frequency range & returning in 1 minute; 3 right angled directions for 2 hours |
| Shock: | 50G (490m/s ²) acceleration (tested in 6 right angled directions, with 5 shocks in each direction) |

PCB Processing

| | |
|-------------------|--|
| Soldering: | Wave Soldering: For non-supported through-hole, see Profile B in Supplement section. For supported through-hole, 5 seconds maximum @ 250°C maximum. Manual Soldering: See Profile B in Supplement section. |
| Cleaning: | These devices are not process sealed. Hand clean locally using alcohol based solution. |

Standards & Certifications

The SS series devices have not been tested for UL recognition and CSA certification. These switches are designed for use in a low-voltage, low-current circuit. When used as intended in a low-voltage, low-current circuit, the results do not produce hazardous energy.

TYPICAL SWITCH ORDERING EXAMPLE



DESCRIPTION FOR TYPICAL ORDERING EXAMPLE

SS12SDP2LC



POLES & CIRCUITS

| Pole | Model | Slide Position | | | Connected Terminals | | | Throw & Schematics |
|------|-------|----------------|--------|------|---------------------|--------|---------|--------------------|
| | | Right | Center | Left | Right | Center | Left | |
| SP | SS12S | ON | NONE | ON | 2-1 | NONE | 2-3 | SPDT |
| DP | SS22S | ON | NONE | ON | 2-1 5-4 | NONE | 2-3 5-6 | DPDT |

Note: Terminal numbers are not actually on switch. Isolated LED circuit requires external power source.

TERMINAL SPACING

D Inch .100" x .100"

Single Pole Models



Double Pole Models

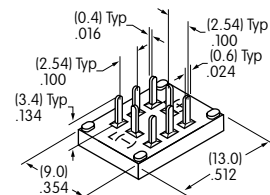

CONTACT MATERIALS & RATINGS

2

Silver over Phosphor Bronze

Power Level

0.1A @ 30V DC

TYPICAL SWITCH DIMENSIONS

Single & Double Pole

Top Actuated

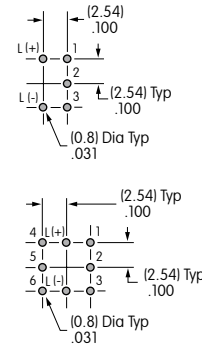
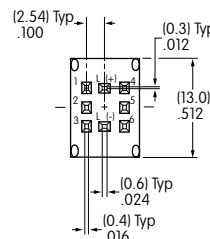
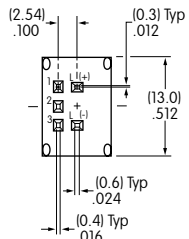
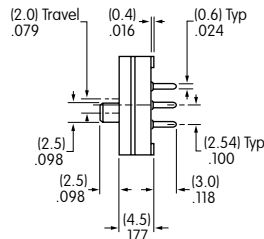
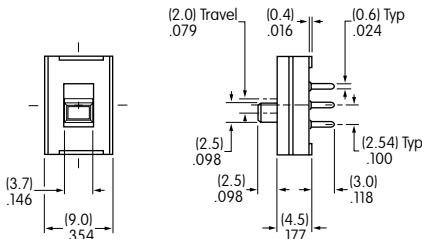

SS22SDP2LC

Single & Double Pole

Side Actuated

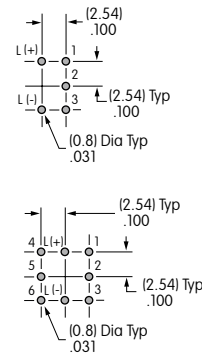
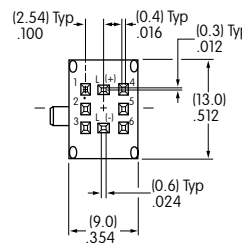
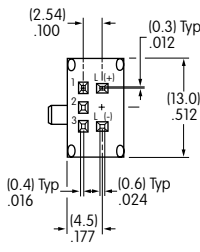
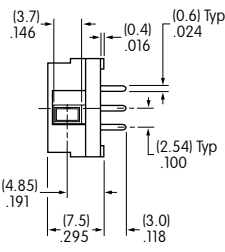
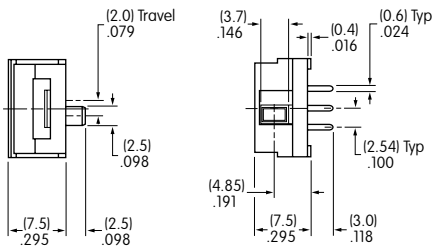

SS12SDH2LC

LED COLORS & SPECIFICATIONS

LEDs are supplied as an integral part of the switch (not available separately). The lamp circuit is independent of switch operation. Electrical specifications shown are determined at a basic temperature of 25°C. If the source voltage exceeds the rated voltage, a ballast resistor is required. The resistor value can be calculated by using the formula given in the Supplement.

| <div style="border: 1px solid black; padding: 2px;">L</div> Isolated, 1-element  | Color | <div style="border: 1px solid black; padding: 2px;">C</div> Red | <div style="border: 1px solid black; padding: 2px;">E</div> Yellow | <div style="border: 1px solid black; padding: 2px;">F</div> Green |
|--|----------------------|---|--|---|
| | Forward Peak Current | I_{FM} | 30mA | 30mA |
| Typical Forward Current | I_F | 16mA | 16mA | 16mA |
| Forward Voltage | V_F | 1.98V | 2.06V | 2.16V |
| Reverse Peak Voltage | V_{RM} | 5V | 5V | 5V |
| Current Reduction Rate Above 25°C | ΔI_F | 0.40mA/°C | 0.42mA/°C | 0.33mA/°C |
| Ambient Temperature Range | | -15° ~ +60°C | | |

OPTIONAL CAP

AT4065 Slide Cap

Material: Polycarbonate

Cap can be assembled on request

Cap Color: Black only

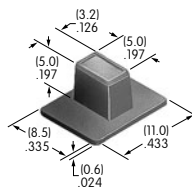

Window color should match LED color.

Colors Available:

C Red E Yellow F Green

Компания «Life Electronics» занимается поставками электронных компонентов импортного и отечественного производства от производителей и со складов крупных дистрибьюторов Европы, Америки и Азии.

С конца 2013 года компания активно расширяет линейку поставок компонентов по направлению коаксиальный кабель, кварцевые генераторы и конденсаторы (керамические, пленочные, электролитические), за счёт заключения дистрибьюторских договоров

Мы предлагаем:

- Конкурентоспособные цены и скидки постоянным клиентам.
- Специальные условия для постоянных клиентов.
- Подбор аналогов.
- Поставку компонентов в любых объемах, удовлетворяющих вашим потребностям.
- Приемлемые сроки поставки, возможна ускоренная поставка.
- Доставку товара в любую точку России и стран СНГ.
- Комплексную поставку.
- Работу по проектам и поставку образцов.
- Формирование склада под заказчика.
- Сертификаты соответствия на поставляемую продукцию (по желанию клиента).
- Тестирование поставляемой продукции.
- Поставку компонентов, требующих военную и космическую приемку.
- Входной контроль качества.
- Наличие сертификата ISO.

В составе нашей компании организован Конструкторский отдел, призванный помогать разработчикам, и инженерам.

Конструкторский отдел помогает осуществить:

- Регистрацию проекта у производителя компонентов.
- Техническую поддержку проекта.
- Защиту от снятия компонента с производства.
- Оценку стоимости проекта по компонентам.
- Изготовление тестовой платы монтаж и пусконаладочные работы.



Тел: +7 (812) 336 43 04 (многоканальный)

Email: org@lifeelectronics.ru