

## Slim and Space-saving Power Plug-in Relay

- Reduces wiring work by 60% when combined with the P2RF-□-PU Push-In Plus Socket (according to actual OMRON measurements).
- Lockable test button models available.
- Built-in mechanical operation indicator.
- Provided with nameplate.
- AC type is equipped with a coil-disconnection self-diagnostic function (LED type).
- High switching power (1-pole: 10 A).



For the most recent information on models that have been certified for safety standards, refer to your OMRON website.

## Model Number Structure

### Model Number Legend

G2R - □ - S □ □ (S)  
 1 2 3 4 5

**1. Number of Poles**

- 1: 1 pole
- 2: 2 poles

**2. Terminals**

- S: Plug-in

**3. Classification**

- Blank: General-purpose
- N: LED indicator
- D: Diode
- ND: LED indicator and diode
- NI: LED indicator with test button
- NDI: LED indicator and diode with test button

**4. Rated Coil Voltage**

**5. Mechanical operation indicator and Nameplate**

- (S): Models with mechanical operation indicator and Nameplate

**Note:** Contact your OMRON representative for Relays with gold-plated contacts.

## Ordering Information

When your order, specify the rated voltage.

### List of Models

Classification	Coil ratings	Contact form	
		SPDT	DPDT
General-purpose	AC 24, 110, 120, 230, 240 DC 6, 12, 24, 48	G2R-1-S (S)	G2R-2-S (S)
LED indicator		G2R-1-SN (S)	G2R-2-SN (S)
LED indicator with test button		G2R-1-SNI (S)	G2R-2-SNI (S)
Diode	DC 6, 12, 24, 48	G2R-1-SD (S)	G2R-2-SD (S)
LED indicator and diode		G2R-1-SND (S)	G2R-2-SND (S)
LED indicator and diode with test button		G2R-1-SNDI (S)	G2R-2-SNDI (S)

**Note:** 1. The standard models are compliant with UL/CSA and VDE standards. Also, an EC compliance declaration has been made for combinations with the P2RF-□-E, P2RF-□-S and P2RF-□-PU. The Relays bear the CE Marking.

2. Refer to *Connecting Sockets*, below, for applicable Socket models.

3. When ordering, add the rated coil voltage and "(S)" to the model number. Rated coil voltages are given in the coil ratings table.

Example: G2R-1-S 12 VDC (S)

Rated coil voltage

## Accessories (Order Separately)

### Connecting Sockets

Applicable Relay model		Track/surface-mounting Socket		Back-mounting Socket	
		Push-In Plus Terminal Blocks	Screw terminals *	PCB terminals	Solder terminals
		Model	Models	Models	Model
1 pole	G2R-1-S (S)	P2RF-05-PU	P2RF-05 P2RF-05-E	P2R-05P P2R-057P	P2R-05A
2 poles	G2R-2-S (S)	P2RF-08-PU	P2RF-08 P2RF-08-E	P2R-08P P2R-087P	P2R-08A

\* The structure of P2RF-□-E models provides finger protection. Round terminals cannot be used. Use forked crimp terminals.

### Accessories for Push-In Plus Terminal Block Sockets (P2RF-□-PU)

#### Short Bars

Pitch	No. of poles	Colors	Model *	Minimum order (quantity)
7.75 mm	2	Red (R) Blue (S) Yellow (Y)	PYDN-7.75-020□	10
	3		PYDN-7.75-030□	
	4		PYDN-7.75-040□	
	20		PYDN-7.75-200□	
15.5 mm	8		PYDN-15.5-080□	

**Note:** Use the Short Bars for crossover wiring within one Socket or between Sockets.

\* Replace the box (□) in the model number with the code for the covering color.

#### Labels

Model	Minimum order (sheet) (quantity per sheet)
XW5Z-P4.0LB1	5 1 sheet (60 pieces)

### Mounting Tracks

Applicable Socket	Description	Model	Minimum order (quantity)
Track-connecting Socket	Mounting track	50 cm (ℓ) × 7.3 mm (t):	PFP-50N
		1 m (ℓ) × 7.3 mm (t):	PFP-100N
		1 m (ℓ) × 16 mm (t):	PFP-100N2
	End plate *1	PFP-M	10
	Spacer	PFP-S	
Back-connecting Socket	Mounting plate *2	P2R-P	1

\*1. When mounting DIN rail, please use End Plate (PFP-M).

\*2. Used to mount several P2R-05A and P2R-08A Connecting Sockets side by side.

## Specifications

### Coil Ratings

Rated voltage		Rated current*		Coil resistance	Coil inductance (H) (ref. value)		Must operate voltage	Must release voltage	Max. voltage	Power consumption (approx.)
		50 Hz	60 Hz		Armature OFF	Armature ON				
AC	24 V	43.5 mA	37.4 mA	253 Ω	0.81	1.55	80% max.	30% max.	110%	0.9 VA at 60 Hz
	110 V	9.5 mA	8.2 mA	5,566 Ω	13.33	26.83				
	120 V	8.6 mA	7.5 mA	7,286 Ω	16.13	32.46				
	230 V	4.4 mA	3.8 mA	27,172 Ω	72.68	143.90				
	240 V	3.7 mA	3.2 mA	30,360 Ω	90.58	182.34				

Rated voltage		Rated current*		Coil resistance	Coil inductance (H) (ref. value)		Must operate voltage	Must release voltage	Max. voltage	Power consumption (approx.)
		50 Hz	60 Hz		Armature OFF	Armature ON				
DC	6 V	87.0 mA		69 Ω	0.25	0.48	70% max.	15% min.	110%	0.53 W
	12 V	43.2 mA		278 Ω	0.98	2.35				
	24 V	21.6 mA		1,113 Ω	3.60	8.25				
	48 V	11.4 mA		4,220 Ω	15.2	29.82				

- Note:**
1. The rated current and coil resistance are measured at a coil temperature of 23°C with tolerances of +15%/-20% for the AC rated current and ±10% for the DC coil resistance.
  2. The AC coil resistance and inductance values are reference values only (at 60 Hz).
  3. Operating characteristics were measured at a coil temperature of 23°C.
  4. The maximum voltage is the maximum possible value of the voltage that can be applied to the relay coil. It is not the maximum voltage that can be applied continuously.

### Contact Ratings

Number of poles	1 pole		2 poles	
	Resistive load (cosφ = 1)	Inductive load (cosφ = 0.4; L/R = 7 ms)	Resistive load (cosφ = 1)	Inductive load (cosφ = 0.4; L/R = 7 ms)
Rated load	10 A at 250 VAC; 10 A at 30 VDC	7.5 A at 250 VAC; 5 A at 30 VDC	5 A at 250 VAC; 5 A at 30 VDC	2 A at 250 VAC; 3 A at 30 VDC
Rated carry current	10 A		5 A	
Max. switching voltage	440 VAC, 125 VDC		380 VAC, 125 VDC	
Max. switching current	10 A		5 A	
Max. switching power	2,500 VA, 300 W	1,875 VA, 150 W	1,250 VA, 150 W	500 VA, 90 W
Failure rate (reference value) *	100 mA at 5 VDC		10 mA at 5 VDC	

**Note:** P level:  $\lambda_{60} = 0.1 \times 10^{-6}$ /operation

\* This value was measured at a switching frequency of 120 operations per minute.

## Characteristics

Item	1 pole	2 poles
Contact configuration	SPDT	
Contact structure	Single	
Contact resistance	100 mΩ max.	
Operate (set) time	15 ms max.	
Release (reset) time	AC: 10 ms max.; DC: 5 ms max. (w/built-in diode: 20 ms max.)	AC: 15 ms max.; DC: 10 ms max. (w/built-in diode: 20 ms max.)
Max. operating frequency	Mechanical: 18,000 operations/hr Electrical: 1,800 operations/hr (under rated load)	
Insulation resistance	1,000 MΩ min. (at 500 VDC)	
Dielectric strength *	5,000 VAC, 50/60 Hz for 1 min between coil and contacts; 1,000 VAC, 50/60 Hz for 1 min between contacts of same polarity	5,000 VAC, 50/60 Hz for 1 min between coil and contacts; 3,000 VAC, 50/60 Hz for 1 min between contacts of different polarity 1,000 VAC, 50/60 Hz for 1 min between contacts of same polarity
Vibration resistance	Destruction: 10 to 55 to 10 Hz, 0.75 mm single amplitude (1.5 mm double amplitude) Malfunction: 10 to 55 to 10 Hz, 0.75 mm single amplitude (1.5 mm double amplitude)	
Shock resistance	Destruction: 1,000 m/s <sup>2</sup> Malfunction: 200 m/s <sup>2</sup> when energized; 100 m/s <sup>2</sup> when not energized	
Endurance	Mechanical: AC coil: 10,000,000 operations min.; DC coil: 20,000,000 operations min. (at 18,000 operations/hr) Electrical: 100,000 operations min. (at 1,800 operations/hr under rated load)	
Ambient temperature	Operating: -40°C to 70°C (with no icing or condensation)	
Ambient humidity	Operating: 5% to 85%	
Weight	Approx. 20 g	

Note: Values in the above table are the initial values.

\*These values are relay only. Please refer to the "Products Related to Common Sockets and DIN Tracks Data Sheet" for connecting sockets.

## Approved Standards

### UL 508 (File No. E41643)

Model	Contact form	Coil ratings	Contact ratings	Operations
G2R-1-S (S)	SPDT	5 to 110 VDC 6 to 240 VAC	10 A, 30 VDC (resistive) 10 A, 250 VAC (general use)	100 × 10 <sup>3</sup>
			TV-3 (NO contact only)	25 × 10 <sup>3</sup>
G2R-2-S (S)	DPDT	5 to 110 VDC 6 to 240 VAC	5 A, 30 VDC (resistive) 5 A, 250 VAC (general use)	100 × 10 <sup>3</sup>
			TV-3 (NO contact only)	25 × 10 <sup>3</sup>

### CSA 22.2 No.0, No.14

#### (File No. LR31928)

Model	Contact form	Coil ratings	Contact ratings	Operations
G2R-1-S (S)	SPDT	5 to 110 VDC 6 to 240 VAC	10 A, 30 VDC (resistive) 10 A, 250 VAC (general use)	100 × 10 <sup>3</sup>
			TV-3 (NO contact only)	25 × 10 <sup>3</sup>
G2R-2-S (S)	DPDT	5 to 110 VDC 6 to 240 VAC	5 A, 30 VDC (resistive) 5 A, 250 VAC (general use)	100 × 10 <sup>3</sup>
			TV-3 (NO contact only)	25 × 10 <sup>3</sup>

### IEC/VDE (Certificate No. 40015012 EN 61810-1)

Contact form	Coil ratings	Contact ratings	Operations
1 pole	6, 12, 24, 48 VDC 24, 110, 120, 230, 240 VAC	5 A, 440 VAC (cosφ = 1.0) 10 A, 250 VAC (cosφ = 1.0) 10 A, 30 VDC (0 ms)	100 × 10 <sup>3</sup>
2 poles	6, 12, 24, 48 VDC 24, 110, 120, 230, 240 VAC	5 A, 250 VAC (cosφ = 1.0) 5 A, 30 VDC (0 ms)	100 × 10 <sup>3</sup>

### LR

Number of poles	Coil ratings	Contact ratings	Operations
1 pole	5 to 110 VDC 6 to 240 VDC	10 A, 250 VAC (general use) 7.5 A, 250 VAC (PF0.4) 10 A, 30 VDC (resistive) 5A, 30VDC (L/R=7ms)	100 × 10 <sup>3</sup>
2 poles	5 to 110 VDC 6 to 240 VDC	5 A, 250 VAC (general use) 2 A, 250 VAC (PF0.4) 5 A, 30 VDC (resistive) 3A, 30VDC (L/R=7ms)	100 × 10 <sup>3</sup>

# Engineering Data

## Maximum Switching Power

G2R-1-S (S)



G2R-2-S (S)



## Endurance

G2R-1-S (S)



G2R-2-S (S)



## Ambient Temperature vs Maximum Coil Voltage



# Dimensions

Note: All units are in millimeters unless otherwise indicated.

## SPDT Relays

G2R-1-S (S), G2R-1-SN (S), G2R-1-SNI (S)  
 G2R-1-SD (S), G2R-1-SND (S), G2R-1-SNDI (S)

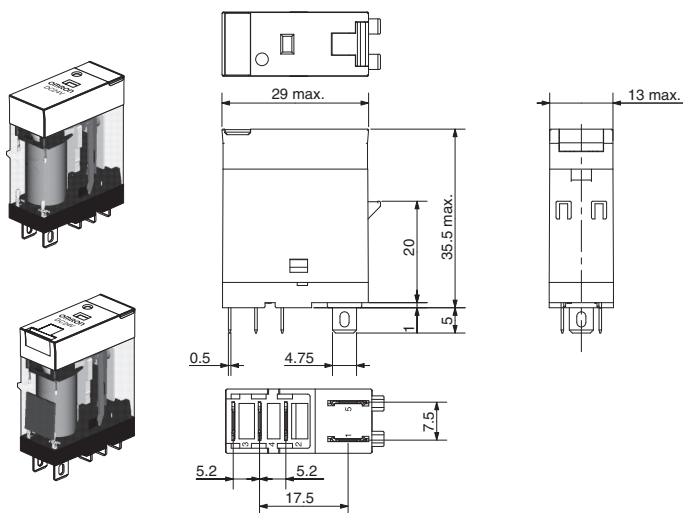

## Terminal Arrangement/Internal Connections (Bottom View)

G2R-1-S (S)

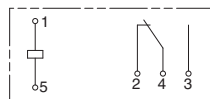

G2R-1-SD (S) (DC)

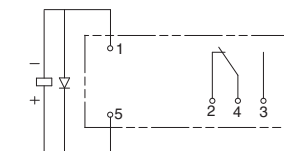

G2R-1-SN (S), G2R-1-SNI (S) (AC)

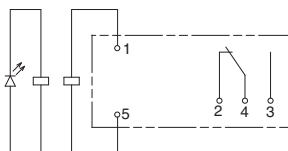

G2R-1-SN (S), G2R-1-SNI (S) (DC)

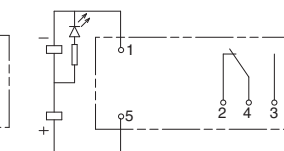

G2R-1-SND (S), G2R-1-SNDI (S) (DC)

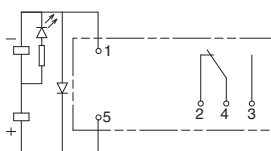

## DPDT Relays

G2R-2-S (S), G2R-2-SN (S), G2R-2-SNI (S)  
 G2R-2-SD (S), G2R-2-SND (S), G2R-2-SNDI (S)

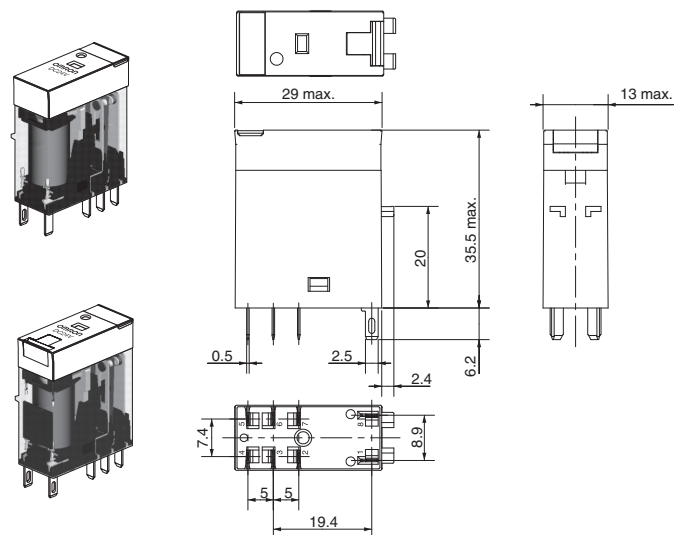

## Terminal Arrangement/Internal Connections (Bottom View)

G2R-2-S (S)

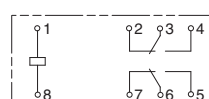

G2R-2-SD (S) (DC)

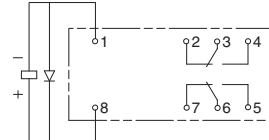

G2R-2-SN (S), G2R-2-SNI (S) (AC)

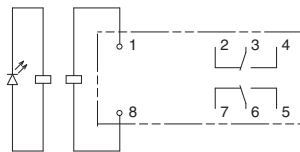

G2R-2-SN (S), G2R-2-SNI (S) (DC)

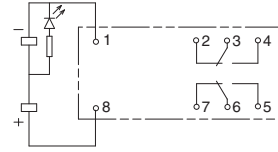

G2R-2-SND (S), G2R-2-SNDI (S) (DC)

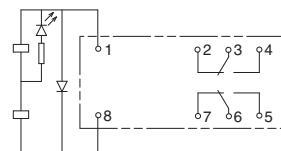

Track/Surface Mounting Sockets

P2RF-05-PU

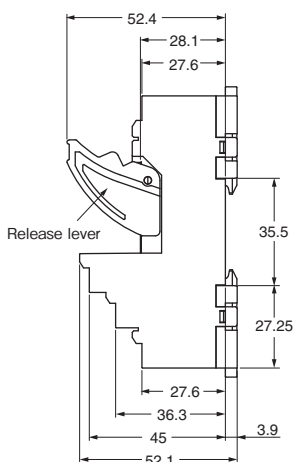
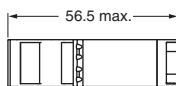
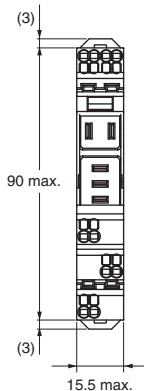
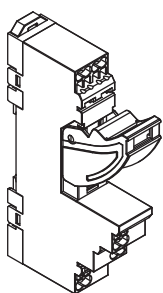

Terminal Arrangement/  
Internal Connection Diagram  
(Top View)

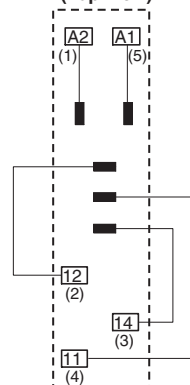

**Note:** The numbers in parentheses are traditionally used terminal numbers.

Mounting Hole Dimensions

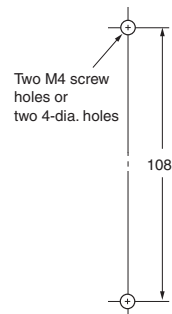

**Note:** Pull out the hooks to mount the Relay with screws.

P2RF-08-PU

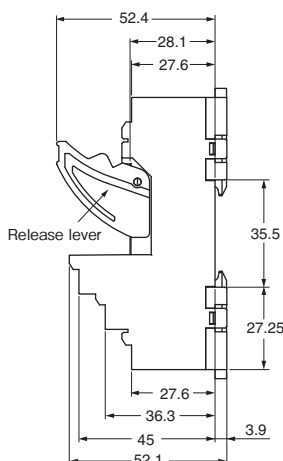
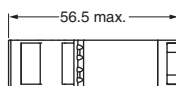
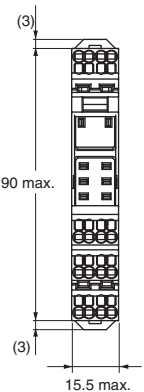
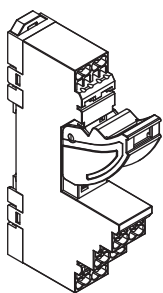

Terminal Arrangement/  
Internal Connection Diagram  
(Top View)

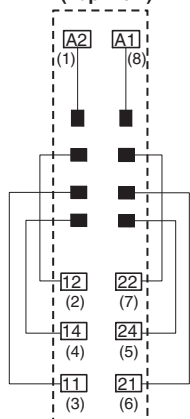

**Note:** The numbers in parentheses are traditionally used terminal numbers.

Mounting Hole Dimensions

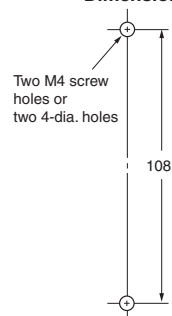

**Note:** Pull out the hooks to mount the Relay with screws.

Accessories for P2RF-□-PU  
Short Bars

PYDN-7.75-□□ (7.75 mm)

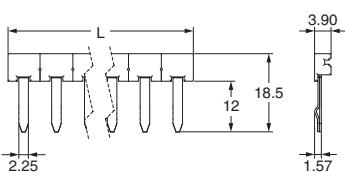

PYDN-15.5-080□ (15.5 mm)

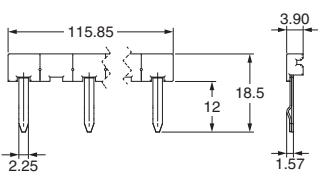

Application	Pitch	No. of poles	L (Length)	Colors	Model *	Maximum carry current
For Contact terminals (common)	7.75 mm	2	15.1	Red (R) Blue (S) Yellow (Y)	PYDN-7.75-020□	20 A
		3	22.85		PYDN-7.75-030□	
		4	30.6		PYDN-7.75-040□	
		20	154.6		PYDN-7.75-200□	
For Coil terminals	15.5 mm	8	115.85		PYDN-15.5-080□	

\* Replace the box (□) in the model number with the code for the covering color.

**Note:** 1. Use the Short Bars for crossover wiring within one Socket or between Sockets.  
2. When using short bar to coil terminals of P2RF-□□-PU, A1 terminal cannot be used. In case crossover wiring of A1 terminal side is needed, crossover wiring using A1 terminals by wire is possible.

Short bar correspondence table

	Contact terminal (Common)	Coil terminal	
		A1	A2
P2RF-□□-PU	Available	---	○

**P2RF-05-E**



**Terminal Arrangement (Top View)**



**Mounting Holes (for Surface Mounting)**

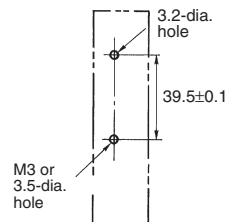

**Note:** Pin numbers in parentheses apply to DIN standard.

**P2RF-08-E**



**Terminal Arrangement (Top View)**



**Mounting Holes (for Surface Mounting)**

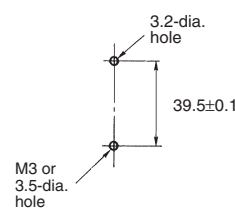

**P2RF-05**



**Terminal Arrangement (Top View)**

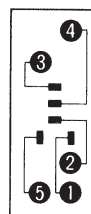

**Mounting Holes (for Surface Mounting)**



**P2RF-08**



**Terminal Arrangement (Top View)**

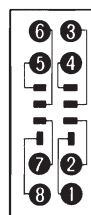

**Mounting Holes (for Surface Mounting)**

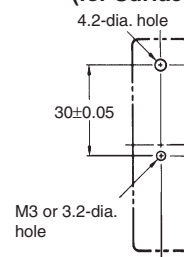



Mounting Height of Relay with Track/Surface Mounting Sockets

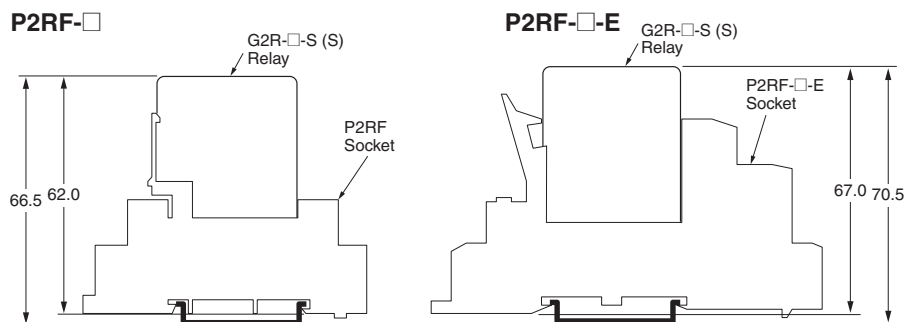
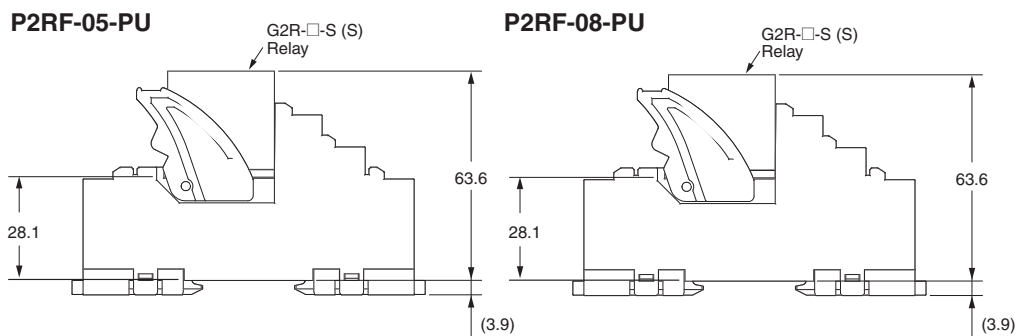

Back-connecting Sockets

P2R-05P (1-pole)

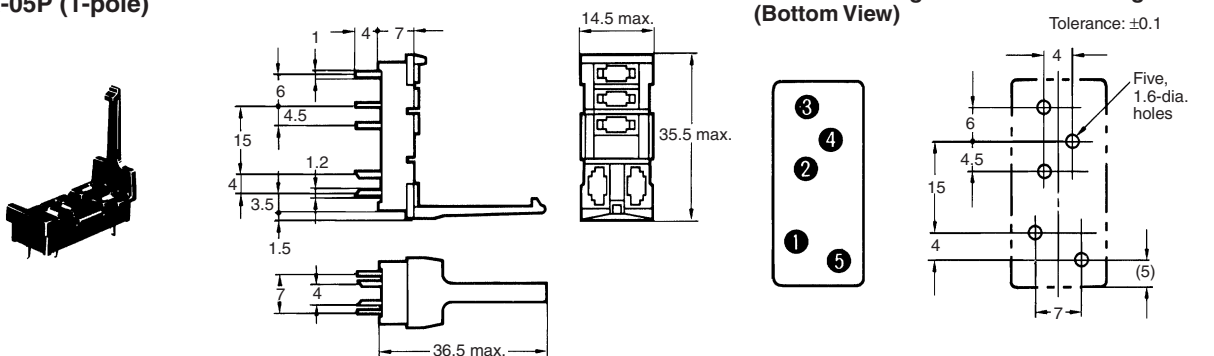

P2R-08P (2-pole)

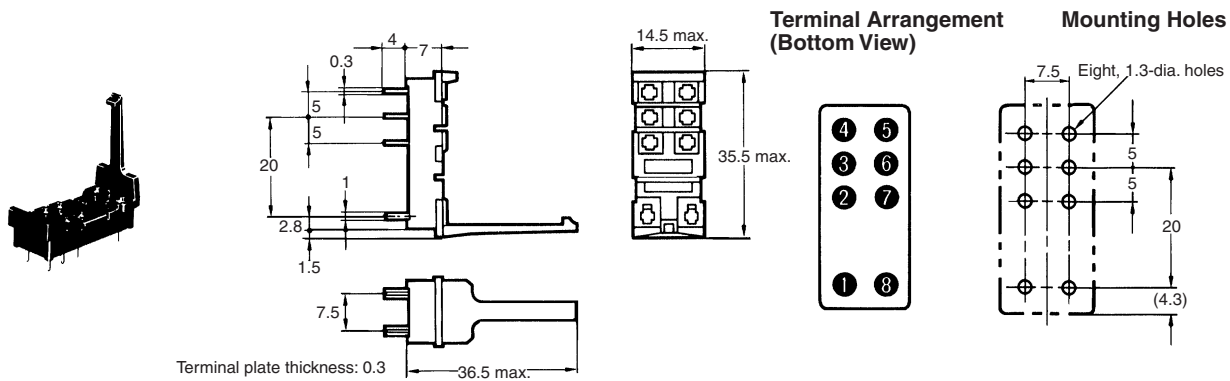

**P2R-05A (1-pole)**



**Terminal Arrangement (Bottom View)**



**Panel Cutout**

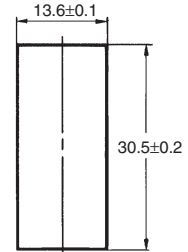

Recommended thickness of the panel is 1.6 to 2.0 mm

**P2R-08A (2-pole)**

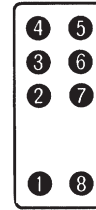

**P2R-057P (1-pole)**

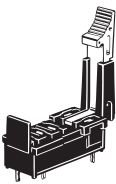

**Terminal Arrangement (Bottom View)**



**Mounting Holes**

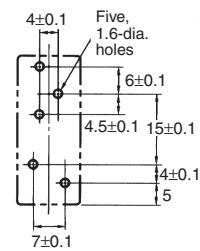

**P2R-087P (2-pole)**



**Terminal Arrangement (Bottom View)**



**Mounting Holes**

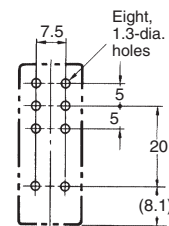

**Mounting Height of Relay with Back-connecting Sockets**

**P2R-□P**

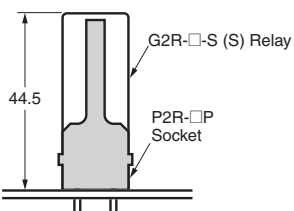

**P2R-□A**



**P2R-□7P**



## Mounting Tracks

PFP-100N, PFP-50N

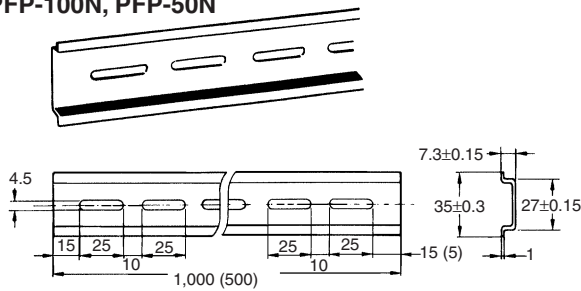

PFP-100N2

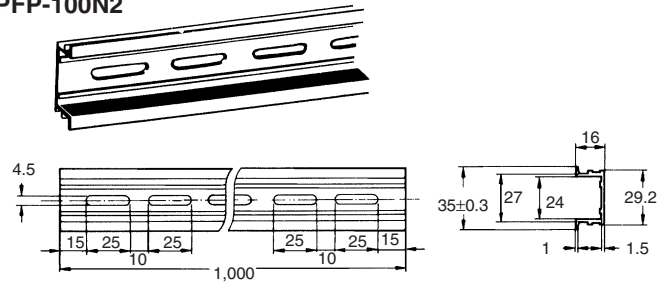

It is recommended to use a panel 1.6 to 2.0 mm thick.

## End Plate

PFP-M

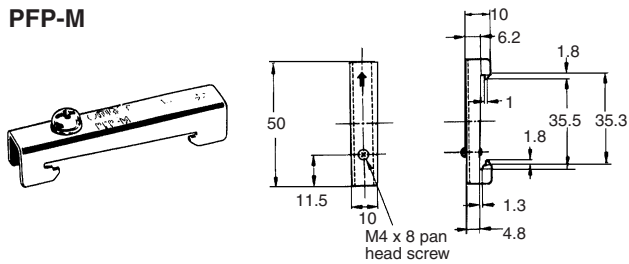

## Spacer

PFP-S

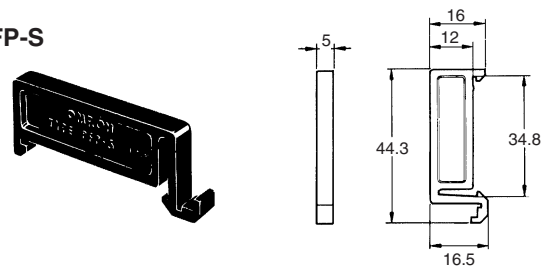

## Mounting Plate

P2R-P



## Safety Precautions

Be sure to read the *Common Precautions for All Relay* in the website at the following URL:

<http://www.ia.omron.com/>.

Refer to *Products Related to Common Sockets and DIN Tracks* for precautions on the applicable Sockets.

Refer to *PYF-□□-PU/P2RF-□□-PU* for precautions on Push-In Plus Terminal Block Sockets.

### Warning Indications



**CAUTION**

Indicates a potentially hazardous situation which, if not avoided, may result in minor or moderate injury or in property damage.



**Cation**

- Do not use the test button for any purpose other than testing. Be sure not to touch the test button accidentally as this will turn the contacts ON. Before using the test button, confirm that circuits, the load, and any other connected item will operate safely.
- Check that the test button is released before turning ON relay circuits.
- If the test button is pulled out too forcefully, it may bypass the momentary testing position and go straight into the locked position.
- Use an insulated tool when you operate the test button.

# Terms and Conditions of Sale

1. **Offer; Acceptance.** These terms and conditions (these "**Terms**") are deemed part of all quotes, agreements, purchase orders, acknowledgments, price lists, catalogs, manuals, brochures and other documents, whether electronic or in writing, relating to the sale of products or services (collectively, the "**Products**") by Omron Electronics LLC and its subsidiary companies ("**Omron**"). Omron objects to any terms or conditions proposed in Buyer's purchase order or other documents which are inconsistent with, or in addition to, these Terms.
2. **Prices; Payment Terms.** All prices stated are current, subject to change without notice by Omron. Omron reserves the right to increase or decrease prices on any unshipped portions of outstanding orders. Payments for Products are due net 30 days unless otherwise stated in the invoice.
3. **Discounts.** Cash discounts, if any, will apply only on the net amount of invoices sent to Buyer after deducting transportation charges, taxes and duties, and will be allowed only if (i) the invoice is paid according to Omron's payment terms and (ii) Buyer has no past due amounts.
4. **Interest.** Omron, at its option, may charge Buyer 1-1/2% interest per month or the maximum legal rate, whichever is less, on any balance not paid within the stated terms.
5. **Orders.** Omron will accept no order less than \$200 net billing.
6. **Governmental Approvals.** Buyer shall be responsible for, and shall bear all costs involved in, obtaining any government approvals required for the importation or sale of the Products.
7. **Taxes.** All taxes, duties and other governmental charges (other than general real property and income taxes), including any interest or penalties thereon, imposed directly or indirectly on Omron or required to be collected directly or indirectly by Omron for the manufacture, production, sale, delivery, importation, consumption or use of the Products sold hereunder (including customs duties and sales, excise, use, turnover and license taxes) shall be charged to and remitted by Buyer to Omron.
8. **Financial.** If the financial position of Buyer at any time becomes unsatisfactory to Omron, Omron reserves the right to stop shipments or require satisfactory security or payment in advance. If Buyer fails to make payment or otherwise comply with these Terms or any related agreement, Omron may (without liability and in addition to other remedies) cancel any unshipped portion of Products sold hereunder and stop any Products in transit until Buyer pays all amounts, including amounts payable hereunder, whether or not then due, which are owing to it by Buyer. Buyer shall in any event remain liable for all unpaid accounts.
9. **Cancellation; Etc.** Orders are not subject to rescheduling or cancellation unless Buyer indemnifies Omron against all related costs or expenses.
10. **Force Majeure.** Omron shall not be liable for any delay or failure in delivery resulting from causes beyond its control, including earthquakes, fires, floods, strikes or other labor disputes, shortage of labor or materials, accidents to machinery, acts of sabotage, riots, delay in or lack of transportation or the requirements of any government authority.
11. **Shipping; Delivery.** Unless otherwise expressly agreed in writing by Omron:
  - a. Shipments shall be by a carrier selected by Omron; Omron will not drop ship except in "break down" situations.
  - b. Such carrier shall act as the agent of Buyer and delivery to such carrier shall constitute delivery to Buyer;
  - c. All sales and shipments of Products shall be FOB shipping point (unless otherwise stated in writing by Omron), at which point title and risk of loss shall pass from Omron to Buyer; provided that Omron shall retain a security interest in the Products until the full purchase price is paid;
  - d. Delivery and shipping dates are estimates only; and
  - e. Omron will package Products as it deems proper for protection against normal handling and extra charges apply to special conditions.
12. **Claims.** Any claim by Buyer against Omron for shortage or damage to the Products occurring before delivery to the carrier must be presented in writing to Omron within 30 days of receipt of shipment and include the original transportation bill signed by the carrier noting that the carrier received the Products from Omron in the condition claimed.
13. **Warranties.** (a) **Exclusive Warranty.** Omron's exclusive warranty is that the Products will be free from defects in materials and workmanship for a period of twelve months from the date of sale by Omron (or such other period expressed in writing by Omron). Omron disclaims all other warranties, express or implied. (b) **Limitations.** OMRON MAKES NO WARRANTY OR REPRESENTATION, EXPRESS OR IMPLIED, ABOUT NON-INFRINGEMENT, MERCHANTABILITY OR FITNESS FOR A PARTICULAR PURPOSE OF THE PRODUCTS. BUYER ACKNOWLEDGES THAT IT ALONE HAS DETERMINED THAT THE PRODUCTS WILL SUITABLY MEET THE REQUIREMENTS OF THEIR INTENDED USE. Omron further disclaims all warranties and responsibility of any type for claims or expenses based on infringement by the Products or otherwise of any intellectual property right. (c) **Buyer Remedy.** Omron's sole obligation hereunder shall be, at Omron's election, to (i) replace (in the form originally shipped with Buyer responsible for labor charges for removal or replacement thereof) the non-complying Product, (ii) repair the non-complying Product, or (iii) repay or credit Buyer an amount equal to the purchase price of the non-complying Product; provided that in no event shall Omron be responsible for warranty, repair, indemnity or any other claims or expenses regarding the Products unless Omron's analysis confirms that the Products were properly handled, stored, installed and maintained and not subject to contamination, abuse, misuse or inappropriate modification. Return of any Products by Buyer must be approved in writing by Omron before shipment. Omron Companies shall not be liable for the suitability or unsuitability or the results from the use of Products in combination with any electrical or electronic components, circuits, system assemblies or any other materials or substances or environments. Any advice, recommendations or information given orally or in writing, are not to be construed as an amendment or addition to the above warranty. See <http://www.omron247.com> or contact your Omron representative for published information.
14. **Limitation on Liability; Etc.** OMRON COMPANIES SHALL NOT BE LIABLE FOR SPECIAL, INDIRECT, INCIDENTAL, OR CONSEQUENTIAL DAMAGES, LOSS OF PROFITS OR PRODUCTION OR COMMERCIAL LOSS IN ANY WAY CONNECTED WITH THE PRODUCTS, WHETHER SUCH CLAIM IS BASED IN CONTRACT, WARRANTY, NEGLIGENCE OR STRICT LIABILITY. Further, in no event shall liability of Omron Companies exceed the individual price of the Product on which liability is asserted.
15. **Indemnities.** Buyer shall indemnify and hold harmless Omron Companies and their employees from and against all liabilities, losses, claims, costs and expenses (including attorney's fees and expenses) related to any claim, investigation, litigation or proceeding (whether or not Omron is a party) which arises or is alleged to arise from Buyer's acts or omissions under these Terms or in any way with respect to the Products. Without limiting the foregoing, Buyer (at its own expense) shall indemnify and hold harmless Omron and defend or settle any action brought against such Companies to the extent based on a claim that any Product made to Buyer specifications infringed intellectual property rights of another party.
16. **Property; Confidentiality.** Any intellectual property in the Products is the exclusive property of Omron Companies and Buyer shall not attempt to duplicate it in any way without the written permission of Omron. Notwithstanding any charges to Buyer for engineering or tooling, all engineering and tooling shall remain the exclusive property of Omron. All information and materials supplied by Omron to Buyer relating to the Products are confidential and proprietary, and Buyer shall limit distribution thereof to its trusted employees and strictly prevent disclosure to any third party.
17. **Export Controls.** Buyer shall comply with all applicable laws, regulations and licenses regarding (i) export of products or information; (ii) sale of products to "forbidden" or other proscribed persons; and (iii) disclosure to non-citizens of regulated technology or information.
18. **Miscellaneous.** (a) **Waiver.** No failure or delay by Omron in exercising any right and no course of dealing between Buyer and Omron shall operate as a waiver of rights by Omron. (b) **Assignment.** Buyer may not assign its rights hereunder without Omron's written consent. (c) **Law.** These Terms are governed by the law of the jurisdiction of the home office of the Omron company from which Buyer is purchasing the Products (without regard to conflict of law principles). (d) **Amendment.** These Terms constitute the entire agreement between Buyer and Omron relating to the Products, and no provision may be changed or waived unless in writing signed by the parties. (e) **Severability.** If any provision hereof is rendered ineffective or invalid, such provision shall not invalidate any other provision. (f) **Setoff.** Buyer shall have no right to set off any amounts against the amount owing in respect of this invoice. (g) **Definitions.** As used herein, "including" means "including without limitation"; and "Omron Companies" (or similar words) mean Omron Corporation and any direct or indirect subsidiary or affiliate thereof.

## Certain Precautions on Specifications and Use

1. **Suitability of Use.** Omron Companies shall not be responsible for conformity with any standards, codes or regulations which apply to the combination of the Product in the Buyer's application or use of the Product. At Buyer's request, Omron will provide applicable third party certification documents identifying ratings and limitations of use which apply to the Product. This information by itself is not sufficient for a complete determination of the suitability of the Product in combination with the end product, machine, system, or other application or use. Buyer shall be solely responsible for determining appropriateness of the particular Product with respect to Buyer's application, product or system. Buyer shall take application responsibility in all cases but the following is a non-exhaustive list of applications for which particular attention must be given: (i) Outdoor use, uses involving potential chemical contamination or electrical interference, or conditions or uses not described in this document. (ii) Use in consumer products or any use in significant quantities. (iii) Energy control systems, combustion systems, railroad systems, aviation systems, medical equipment, amusement machines, vehicles, safety equipment, and installations subject to separate industry or government regulations. (iv) Systems, machines and equipment that could present a risk to life or property. Please know and observe all prohibitions of use applicable to this Product. NEVER USE THE PRODUCT FOR AN APPLICATION INVOLVING SERIOUS RISK TO LIFE OR PROPERTY OR IN LARGE QUANTITIES WITHOUT ENSURING THAT THE SYSTEM AS A WHOLE HAS BEEN DESIGNED TO ADDRESS THE RISKS, AND THAT THE OMRON'S PRODUCT IS PROPERLY RATED AND INSTALLED FOR THE INTENDED USE WITHIN THE OVERALL EQUIPMENT OR SYSTEM.
2. **Programmable Products.** Omron Companies shall not be responsible for the user's programming of a programmable Product, or any consequence thereof.
3. **Performance Data.** Data presented in Omron Company websites, catalogs and other materials is provided as a guide for the user in determining suitability and does not constitute a warranty. It may represent the result of Omron's test conditions, and the user must correlate it to actual application requirements. Actual performance is subject to the Omron's Warranty and Limitations of Liability.
4. **Change in Specifications.** Product specifications and accessories may be changed at any time based on improvements and other reasons. It is our practice to change part numbers when published ratings or features are changed, or when significant construction changes are made. However, some specifications of the Product may be changed without any notice. When in doubt, special part numbers may be assigned to fix or establish key specifications for your application. Please consult with your Omron's representative at any time to confirm actual specifications of purchased Product.
5. **Errors and Omissions.** Information presented by Omron Companies has been checked and is believed to be accurate; however, no responsibility is assumed for clerical, typographical or proofreading errors or omissions.

**OMRON AUTOMATION AMERICAS HEADQUARTERS** • Chicago, IL USA • 847.843.7900 • 800.556.6766 • [www.omron247.com](http://www.omron247.com)

**OMRON CANADA, INC. • HEAD OFFICE**

Toronto, ON, Canada • 416.286.6465 • 866.986.6766 • [www.omron247.com](http://www.omron247.com)

**OMRON ELECTRONICS DE MEXICO • HEAD OFFICE**

México DF • 52.55.59.01.43.00 • 01-800-226-6766 • [mela@omron.com](mailto:mela@omron.com)

**OMRON ELECTRONICS DE MEXICO • SALES OFFICE**

Apodaca, N.L. • 52.81.11.56.99.20 • 01-800-226-6766 • [mela@omron.com](mailto:mela@omron.com)

**OMRON ELETRÔNICA DO BRASIL LTDA • HEAD OFFICE**

São Paulo, SP, Brasil • 55.11.2101.6300 • [www.omron.com.br](http://www.omron.com.br)

**OMRON ARGENTINA • SALES OFFICE**

Cono Sur • 54.11.4783.5300

**OMRON CHILE • SALES OFFICE**

Santiago • 56.9.9917.3920

**OTHER OMRON LATIN AMERICA SALES**

54.11.4783.5300

**OMRON EUROPE B.V.** • Wegalaan 67-69, NL-2132 JD, Hoofddorp, The Netherlands. • +31 (0) 23 568 13 00 • [www.industrial.omron.eu](http://www.industrial.omron.eu)

*Authorized Distributor:*

**Controllers & I/O**

- Machine Automation Controllers (MAC) • Motion Controllers
- Programmable Logic Controllers (PLC) • Temperature Controllers • Remote I/O

**Robotics**

- Industrial Robots • Mobile Robots

**Operator Interfaces**

- Human Machine Interface (HMI)

**Motion & Drives**

- Machine Automation Controllers (MAC) • Motion Controllers • Servo Systems
- Frequency Inverters

**Vision, Measurement & Identification**

- Vision Sensors & Systems • Measurement Sensors • Auto Identification Systems

**Sensing**

- Photoelectric Sensors • Fiber-Optic Sensors • Proximity Sensors
- Rotary Encoders • Ultrasonic Sensors

**Safety**

- Safety Light Curtains • Safety Laser Scanners • Programmable Safety Systems
- Safety Mats and Edges • Safety Door Switches • Emergency Stop Devices
- Safety Switches & Operator Controls • Safety Monitoring/Force-guided Relays

**Control Components**

- Power Supplies • Timers • Counters • Programmable Relays
- Digital Panel Meters • Monitoring Products

**Switches & Relays**

- Limit Switches • Pushbutton Switches • Electromechanical Relays
- Solid State Relays

**Software**

- Programming & Configuration • Runtime

Компания «Life Electronics» занимается поставками электронных компонентов импортного и отечественного производства от производителей и со складов крупных дистрибьюторов Европы, Америки и Азии.

С конца 2013 года компания активно расширяет линейку поставок компонентов по направлению коаксиальный кабель, кварцевые генераторы и конденсаторы (керамические, пленочные, электролитические), за счёт заключения дистрибьюторских договоров

Мы предлагаем:

- Конкуренспособные цены и скидки постоянным клиентам.
- Специальные условия для постоянных клиентов.
- Подбор аналогов.
- Поставку компонентов в любых объемах, удовлетворяющих вашим потребностям.
- Приемлемые сроки поставки, возможна ускоренная поставка.
- Доставку товара в любую точку России и стран СНГ.
- Комплексную поставку.
- Работу по проектам и поставку образцов.
- Формирование склада под заказчика.
- Сертификаты соответствия на поставляемую продукцию (по желанию клиента).
- Тестирование поставляемой продукции.
- Поставку компонентов, требующих военную и космическую приемку.
- Входной контроль качества.
- Наличие сертификата ISO.

В составе нашей компании организован Конструкторский отдел, призванный помогать разработчикам, и инженерам.

Конструкторский отдел помогает осуществить:

- Регистрацию проекта у производителя компонентов.
- Техническую поддержку проекта.
- Защиту от снятия компонента с производства.
- Оценку стоимости проекта по компонентам.
- Изготовление тестовой платы монтаж и пусконаладочные работы.



Тел: +7 (812) 336 43 04 (многоканальный)

Email: [org@lifeelectronics.ru](mailto:org@lifeelectronics.ru)