

Single, High Current, LED Driver Demoboard

General Description

The AT9919DB1 demoboard is a high current LED driver designed to drive one LED at 1.0A from a 9.0 - 16VDC input. The demoboard uses Supertex's AT9919 hysteretic buck LED driver IC.

The AT9919DB1 includes two PWM dimming modes. The analog control of the PWM dimming mode allows the user to dim the LED using a 0 - 2.0V analog signal applied between the ADIM and GND pins (0V gives 0% and 2.0V gives 100%). In this mode, the PWM dimming frequency is set to 1kHz on the board. The digital control of PWM dimming mode allows the user to dim the LEDs using an external, TTL-compatible square wave source applied between DIM and GND. In this case, the PWM dimming frequency and duty ratio are set by the external square wave source.

Specifications

Parameter	Value
Input voltage	9.0 - 16VDC (steady state) 40V max (transient)
Reverse polarity protection	60V (max)
Output voltage	2.0 - 5.0V
Output current	1.0A ± 5%
Output current ripple (@13.5V input and 3.3V output)	16% (peak to peak)
Full load efficiency (@13.5V input)	84%
Open LED protection	Yes
Output short circuit protection	Yes
Dimensions	25.4mm X 25.4mm

Connection Diagram

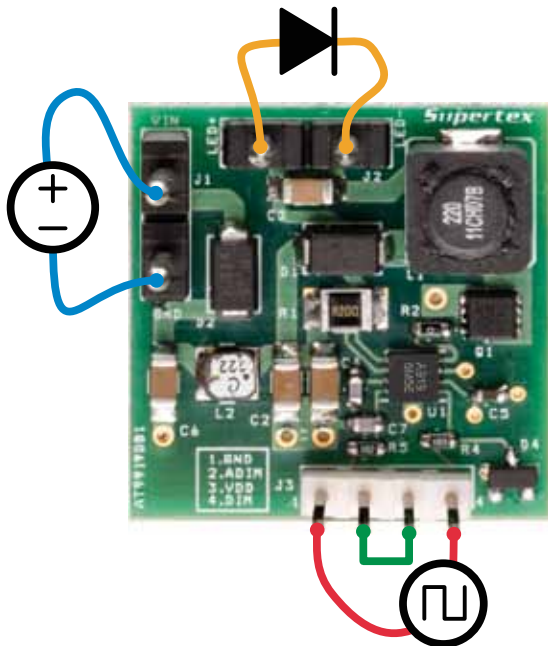

Silk Screen

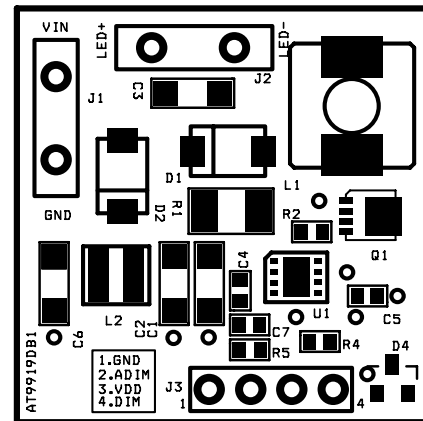

Connections

Input Connection: Connect the input DC voltage between VIN and GND terminals of connector J1 as shown in the connection diagram.

Output Connection: Connect the LEDs between LED+ (anode of LED string) and LED- (cathode of LED string) of connector J2.

PWM Dimming Connection:

1. If no PWM dimming is required, short DIM, VDD and ADIM terminals of connector J3.

2. If dimming using an external PWM dimming source, connect the PWM source between the DIM and GND terminals of connector J3 and short terminals ADIM and VDD. The recommended PWM dimming frequency is $\leq 1.0\text{kHz}$.
3. If dimming using an external analog voltage source, connect the source between the ADIM and GND terminals of connector J3 and short terminals DIM and VDD. The voltage range for control of the PWM dimming is 0 - 2.0V.

Typical Results

Fig. 1. Efficiency vs. Input Voltage Plot

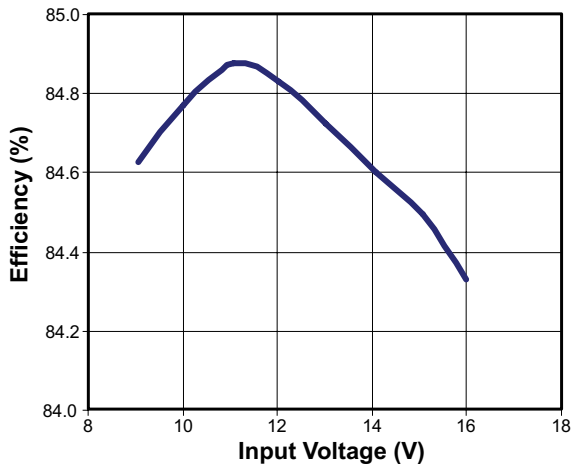

Fig. 2. Line Regulation of LED Current Plot

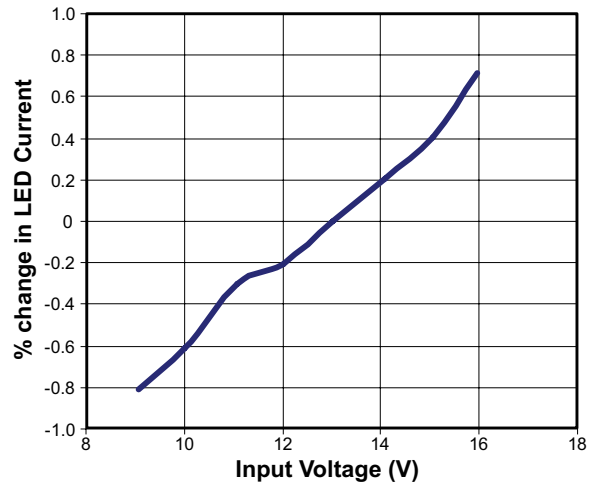

Fig. 3. Efficiency vs. Load Voltage Plot
(@13.5V input)

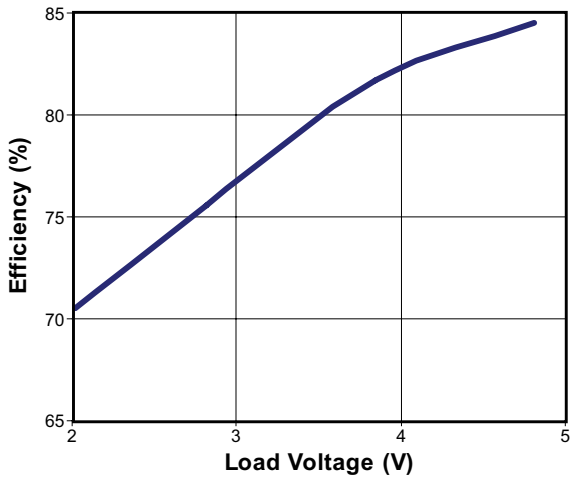

Fig. 4. Load Regulation of LED Current Plot

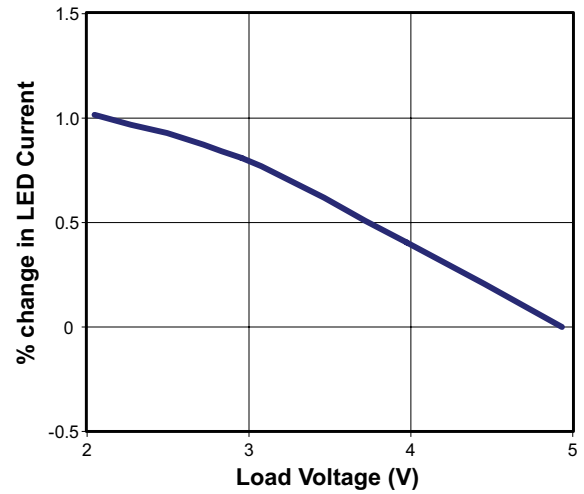

Fig. 5. Switching Frequency vs. Input Voltage Plot
(Full Load)

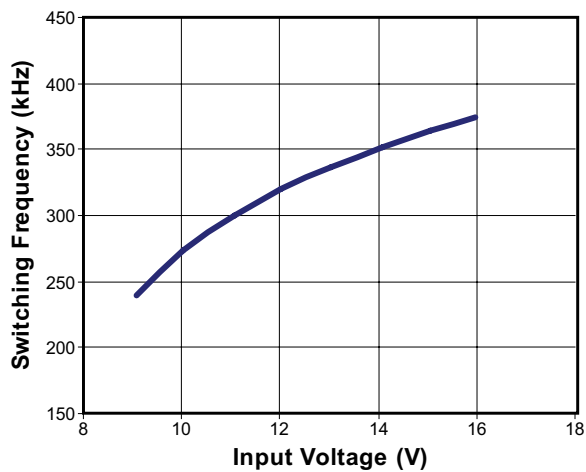
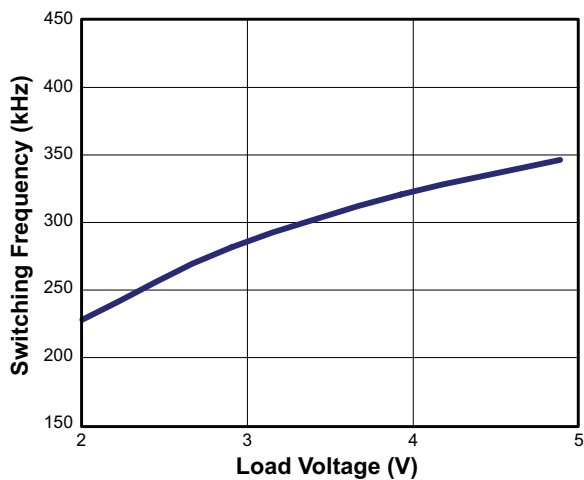
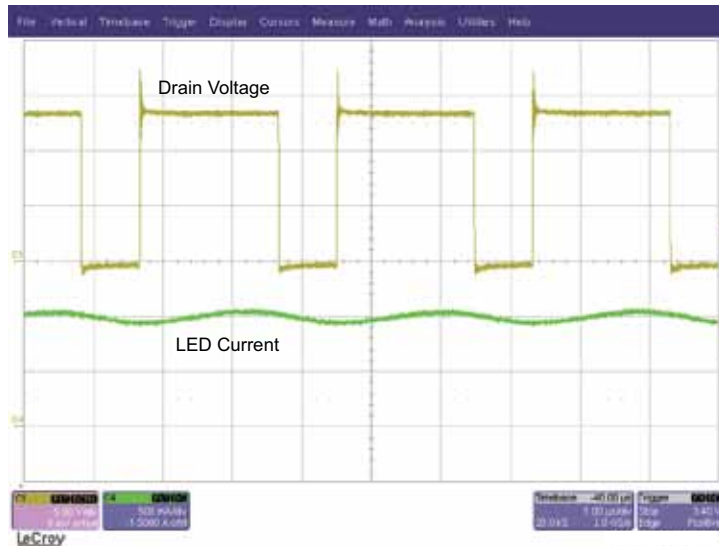

Fig. 6. Switching Frequency vs. Load Voltage Plot
(@13.5V input)



Typical Waveforms (All waveforms are at 13.5V input and 3.3V LED Voltage unless otherwise noted)

Figure 7. Steady State Waveforms



C1 (Yellow) : Drain Voltage (5V/div)
 C4 (Green) : LED Current (500mA/div)
 Time Scale : 1µs/div

Figure 8. Transient Response of the LED Current

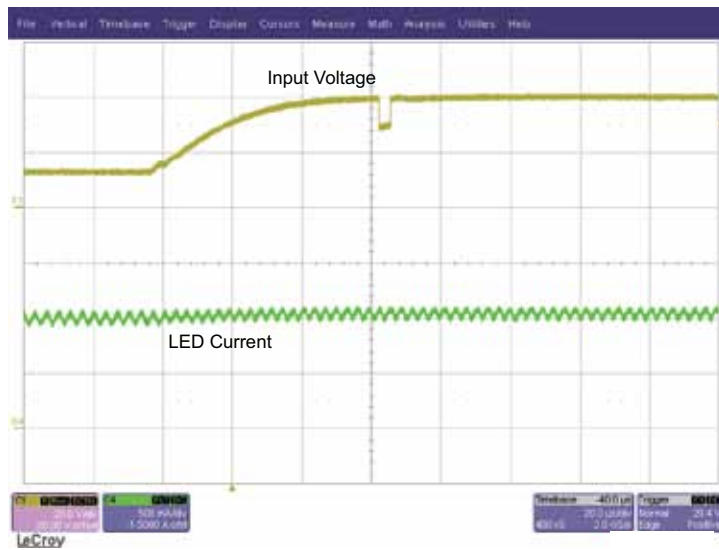

C1 (Yellow) : Input Voltage (20V/div)
 C4 (Green) : LED Current (500mA/div)
 Time Scale : 20µs/div

Typical Waveforms (All waveforms are at 13.5V input and 3.3V LED Voltage unless otherwise noted)

Figure 9. PWM Dimming using the DIM input

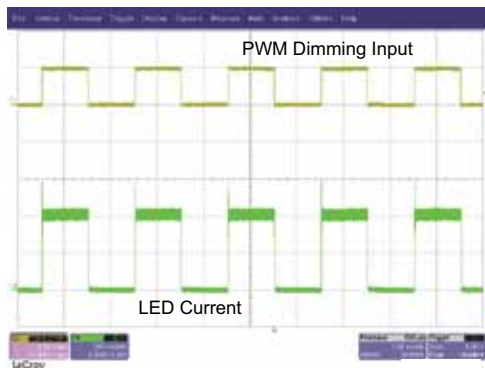

(a) PWM Dimming Performance

Time Scale : 1ms/div

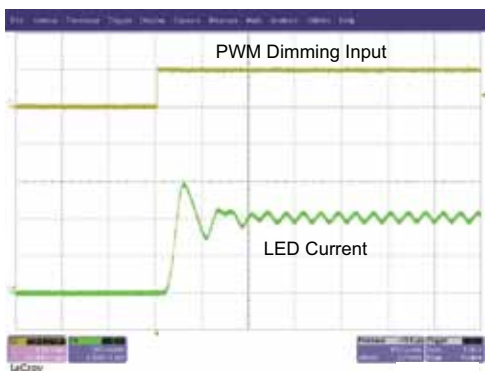

(b) PWM Dimming Rise Time

Time Scale : 10µs/div

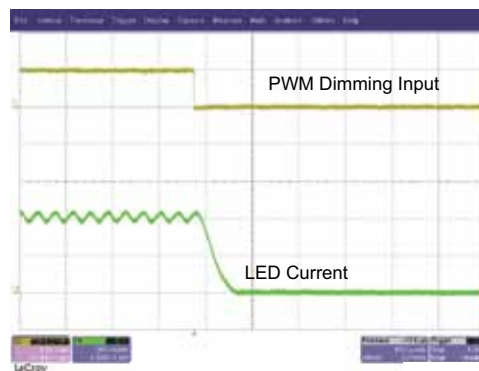

(c) PWM Dimming Fall Time

Time Scale : 10µs/div

C1 (Yellow) : PWMD Input Voltage (5V/div)
 C4 (Green) : LED Current (500mA/div)

Figure 10. PWM Dimming using the ADIM pin

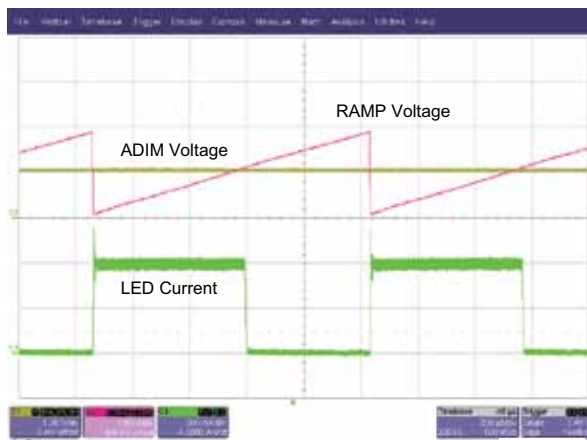

C1 (Yellow) : ADIM Voltage (1V/div)
 C2 (Pink) : RAMP Voltage (1V/div)
 C4 (Green) : LED Current (500mA/div)
 Time Scale : 200µs/div

AT9919DB1 Schematic Diagram

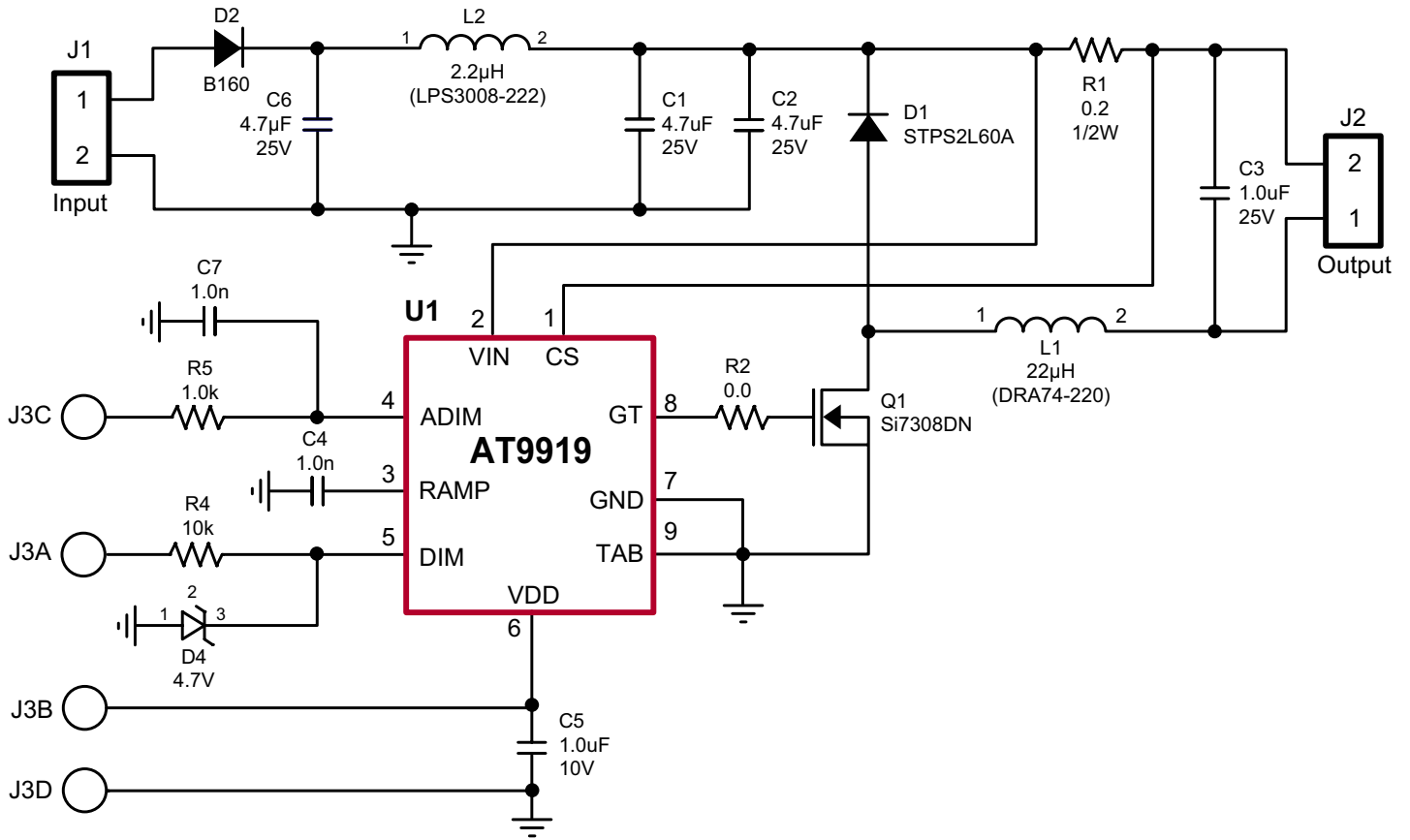

Bill of Materials

Item #	Qty	RefDes	Description	Package	Manufacturer	Manufacturer's Part Number
1	3	C1, C2, C6	4.7 μ F, 25V, 10% X7R ceramic capacitor	SMD1206	Murata	GRM31CR71E475KA88L
2	1	C3	1.0 μ F, 25V, 10% X7R ceramic capacitor	SMD1206	Kemet	C1206C105K3RACTU
3	2	C4, C7	1.0nF, 50V, 5%, C0G ceramic capacitor	SMD0603	TDK Corp	C1608C0G1H102J
4	1	C5	1.0 μ F, 10V, 10% X7R ceramic capacitor	SMD0603	Taiyo Yuden	LMK107B7105KA-T
5	1	D1	60V, 2A schottky diode	SMA	ST Micro	STPS2L60A
6	1	D2	60V, 1A schottky diode	SMA	ST Micro	STPS1L60A
7	1	D4	4.7V, 350mW zener diode	SOT-23	Diodes Inc	BZX84C4V7-7-F
8	2	J1, J2	2 position, 5mm pitch, vertical header	Thru-Hole	On Shore Tech	EDSTL130/02
9	1	J3	4 position, 0.100" pitch, vertical header	Thru-Hole	Molex	22-03-2041
10	1	L1	22 μ H, 1.8A rms, 1.7A sat inductor	SMT	Coiltronics	DRA74-220-R
11	1	L2	2.2 μ H, 1.0A rms, 1.0A sat inductor	SMT	Coilcraft	LPS3008-222
12	1	Q1	60V, 72m Ω , 9nC N-channel FET	Powerpak 1212-8	Vishay	SI7308DN-T1-E3
13	1	R1	0.2 Ω , 1/2W, 1% chip resistor	SMD1210	Rohm	MCR25JZHFLR200
14	1	R2	0.0 Ω , 1/10W, 5% chip resistor	SMD0603	Panasonic	ERJ-3GEY0R00V
15	1	R4	10k Ω , 1/10W, 5% chip resistor	SMD0603	Panasonic	ERJ-3GEYJ103V
16	1	R5	1k Ω , 1/10W, 5% chip resistor	SMD0603	Panasonic	ERJ-3GEYJ102V
17	1	U1	Hysteretic Buck LED Driver	DFN-8	Supertex	AT9919

Supertex inc. does not recommend the use of its products in life support applications, and will not knowingly sell them for use in such applications unless it receives an adequate "product liability indemnification insurance agreement." **Supertex inc.** does not assume responsibility for use of devices described, and limits its liability to the replacement of the devices determined defective due to workmanship. No responsibility is assumed for possible omissions and inaccuracies. Circuitry and specifications are subject to change without notice. For the latest product specifications refer to the **Supertex inc.** (website: <http://www.supertex.com>)

Компания «Life Electronics» занимается поставками электронных компонентов импортного и отечественного производства от производителей и со складов крупных дистрибьюторов Европы, Америки и Азии.

С конца 2013 года компания активно расширяет линейку поставок компонентов по направлению коаксиальный кабель, кварцевые генераторы и конденсаторы (керамические, пленочные, электролитические), за счёт заключения дистрибьюторских договоров

Мы предлагаем:

- Конкурентоспособные цены и скидки постоянным клиентам.
- Специальные условия для постоянных клиентов.
- Подбор аналогов.
- Поставку компонентов в любых объемах, удовлетворяющих вашим потребностям.
- Приемлемые сроки поставки, возможна ускоренная поставка.
- Доставку товара в любую точку России и стран СНГ.
- Комплексную поставку.
- Работу по проектам и поставку образцов.
- Формирование склада под заказчика.
- Сертификаты соответствия на поставляемую продукцию (по желанию клиента).
- Тестирование поставляемой продукции.
- Поставку компонентов, требующих военную и космическую приемку.
- Входной контроль качества.
- Наличие сертификата ISO.

В составе нашей компании организован Конструкторский отдел, призванный помогать разработчикам, и инженерам.

Конструкторский отдел помогает осуществить:

- Регистрацию проекта у производителя компонентов.
- Техническую поддержку проекта.
- Защиту от снятия компонента с производства.
- Оценку стоимости проекта по компонентам.
- Изготовление тестовой платы монтаж и пусконаладочные работы.



Тел: +7 (812) 336 43 04 (многоканальный)
Email: org@lifeelectronics.ru