

## Features

- Low Insertion Loss: 0.55 dB @ 2.45 GHz
- High P1dB: 35 dBm @ 2.6 V
- 0.5 micron GaAs pHEMT Process
- Lead-Free 2 mm 8-Lead PDFN Package
- Halogen-Free “Green” Mold Compound
- 260°C Reflow Compatible
- Low gate lag for timing sensitive applications
- 1.8 V Operation with 1.8 V on Voltage Pull Up

## Description

M/A-COM’s MASW-008955 is a GaAs pHEMT MMIC single pole three throw (SP3T) switch in a lead-free 2 mm 8-lead PDFN package. The MASW-008955 is ideally suited for applications where low control voltage, low insertion loss, high isolation, small size, and low cost are required.

Typical applications are for filter and antenna switching in WLAN or Bluetooth systems that connect separate receive functions to a common antenna. This part can be used in all systems operating up to 3.5 GHz requiring low control voltage.

The MASW-008955 is fabricated using a 0.5 micron gate length GaAs pHEMT process. The process features full passivation for performance and reliability.

## Application Schematic

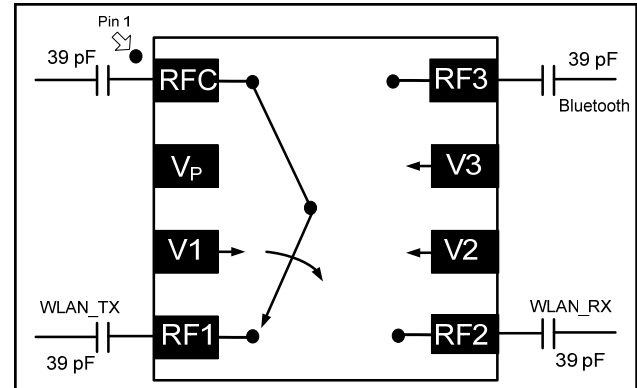

## Pin Configuration

Pin No.	Function	Description
1	RFC	RF In/Out
2	V <sub>P</sub> <sup>3,4</sup>	Optional Voltage Pull Up
3	V1 <sup>3</sup>	Control 1
4	RF1	RF In/Out
5	RF2	RF In/Out
6	V2 <sup>3</sup>	Control 2
7	V3 <sup>3</sup>	Control 3
8	RF3	RF In/Out

3. Depending on system sensitivity optional DC line bypass capacitors (22 pF) may be used.
4. Improved linearity at low control voltage can be obtained by tying pin 2 to the most positive control voltage. Otherwise, leave pin 2 unconnected.

## Ordering Information<sup>1,2</sup>

Part Number	Package
MASW-008955-TR1000	1000 piece reel
MASW-008955-TR3000	3000 piece reel
MASW-008955-001SMB	Sample Test Board

1. Reference Application Note M513 for reel size information.
2. All sample boards include 5 loose parts.

## Absolute Maximum Ratings<sup>5,6</sup>

Parameter	Absolute Maximum
Max Input Power (0.5-3.5 GHz, 2.6 V Control)	35 dBm
RFC – RF1	31 dBm
RFC – RF2	31 dBm
RFC – RF3	31 dBm
V <sub>HI</sub> -V <sub>LO</sub>	8.5 volts
Operating Temperature	-40°C to +85°C
Storage Temperature	-65°C to +150°C

5. Exceeding any one or combination of these limits may cause permanent damage to this device.
6. M/A-COM does not recommend sustained operation near these survivability limits.

\* Restrictions on Hazardous Substances, European Union Directive 2002/95/EC.

## GaAs SP3T Switch DC - 3.5 GHz

Rev. V2

### Electrical Specifications: $T_A = 25^\circ\text{C}$ , $V_C = 0\text{ V} / 2.6\text{ V}$ , $Z_0 = 50\ \Omega$ <sup>7,9</sup>

Parameter	Test Conditions	Units	Min.	Typ.	Max.
Insertion Loss <sup>8</sup>	2.45 GHz, RFC - RF1	dB	—	0.55	0.85
	2.45 GHz, RFC - RF2		—	0.6	0.85
	2.45 GHz, RFC - RF3		—	0.6	0.85
Isolation	2.45 GHz, RFC - RF1	dB	20	22	—
	2.45 GHz, RFC - RF2		20	22	—
	2.45 GHz, RFC - RF3		19	20	—
Return Loss	2.45 GHz	dB	—	20	—
IP3	Two Tone, +10 dBm/tone, 10 MHz Spacing, 2.45 GHz	dBm	—	54	—
IP2	Two Tone, +10 dBm/tone, 10 MHz Spacing, 2.45 GHz	dBm	—	98	—
P0.1dB	2.45 GHz (RF1), 2.6 V	dBm	—	29	—
	2.45 GHz (RF2), 2.6 V			25	
	2.45 GHz (RF3), 2.6 V			25	
	2.45 GHz (RF1), 3 V			32	
	2.45 GHz (RF2), 3 V			28	
	2.45 GHz (RF3), 3 V			28	
P1dB	2.45 GHz (RF1), 2.6 V	dBm	—	35	—
	2.45 GHz (RF2), 2.6 V			31	
	2.45 GHz (RF3), 2.6 V			31	
	2.45 GHz (RF1), 3 V			36	
	2.45 GHz (RF2), 3 V			34	
	2.45 GHz (RF3), 3 V			34	
2nd Harmonic	900 MHz, 2.6 V, +10 dBm	dBc	—	-94	—
	900 MHz, 2.6 V, +20 dBm			-75	
	900 MHz, 3 V, +20 dBm			-80	
	2.45 GHz, 2.6 V, +10 dBm			-86	
	2.45 GHz, 2.6 V, +20 dBm			-70	
	2.45 GHz, 3 V, +20 dBm			-99	
3rd Harmonic	900 MHz, 2.6 V, +10 dBm	dBc	—	-102	—
	900 MHz, 2.6 V, +20 dBm			-80	
	900 MHz, 3 V, +20 dBm			-100	
	2.45 GHz, 2.6 V, +10 dBm			-94	
	2.45 GHz, 2.6 V, +20 dBm			-70	
	2.45 GHz, 3 V, +20 dBm			-78	
Trise, Tfall	10% to 90% RF	ns	—	25	—
	90% to 10% RF			14	
Ton, Toff	50% control to 90% RF	ns	—	30	—
	50% control to 10% RF			26	
Gate Lag	50% control to 100% RF	μs	—	4	—
Control Current	$ V_C  = 2.6\text{V}$	μA	—	4	20
Thermal Resistance	Junction to case	°C/W	—	96	—

7. For positive control voltage, external DC blocking capacitors are required on all RF ports.

8. Insertion loss can be optimized by varying the DC blocking capacitor value, e.g. 100 pF for 100 - 500 MHz, 39 pF for 2.45 GHz.

9. Specifications apply with no connection to pin 2 ( $V_P$ ).

2

**ADVANCED:** Data Sheets contain information regarding a product M/A-COM Technology Solutions is considering for development. Performance is based on target specifications, simulated results, and/or prototype measurements. Commitment to develop is not guaranteed.

**PRELIMINARY:** Data Sheets contain information regarding a product M/A-COM Technology Solutions has under development. Performance is based on engineering tests. Specifications are typical. Mechanical outline has been fixed. Engineering samples and/or test data may be available. Commitment to produce in volume is not guaranteed.

• **North America** Tel: 800.366.2266 / Fax: 978.366.2266

• **Europe** Tel: 44.1908.574.200 / Fax: 44.1908.574.300

• **Asia/Pacific** Tel: 81.44.844.8296 / Fax: 81.44.844.8298

Visit [www.macontech.com](http://www.macontech.com) for additional data sheets and product information.

M/A-COM Technology Solutions Inc. and its affiliates reserve the right to make changes to the product(s) or information contained herein without notice.

## Typical Performance Curves

### Insertion Loss

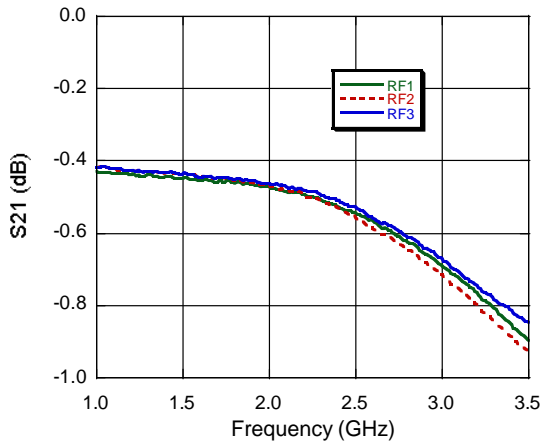

### Isolation

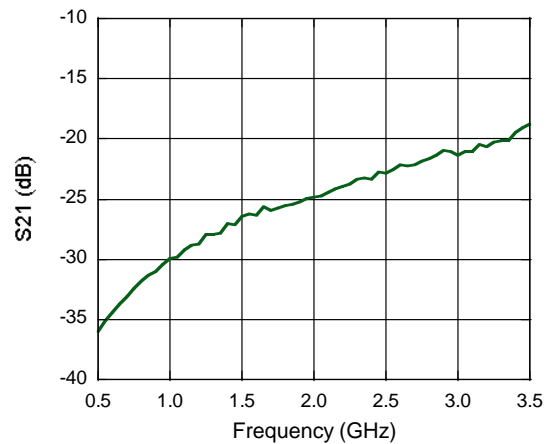

### Return Loss

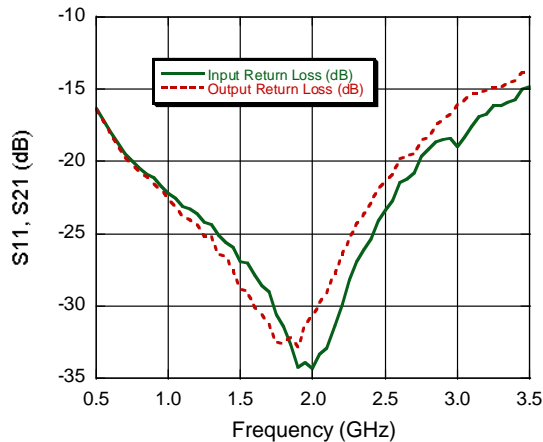

## Handling Procedures

Please observe the following precautions to avoid damage:

## Static Sensitivity

Gallium Arsenide Integrated Circuits are sensitive to electrostatic discharge (ESD) and can be damaged by static electricity. Proper ESD control techniques should be used when handling these devices.

## Truth Table <sup>10,11,12</sup>

V1	V2	V3	RFC - RF1	RFC - RF2	RFC - RF3
1	0	0	On	Off	Off
0	1	0	Off	On	Off
0	0	1	Off	Off	On

10. 0 = 0 V  $\pm$  0.2 V, 1 = 1.8 V to +5 V, minimum  $V_{HI} - V_{LO} = 1.8$  V, maximum  $V_{HI} - V_{LO} = 8.5$  V.

11. For use at low voltage, M/A-COM recommends connecting pin 2 to a voltage equal to the most positive control voltage.

12. Negative control voltage may be used. The '1' in the table would be the most positive (0 V) and the '0' would be the most negative (-3 V for example).

## GaAs SP3T Switch DC - 3.5 GHz

Rev. V2

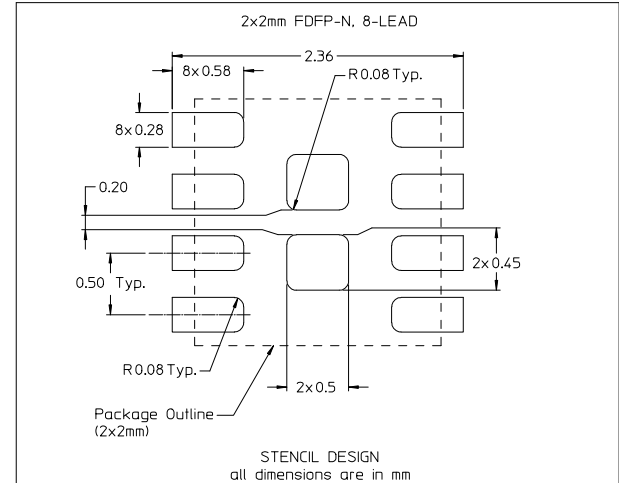
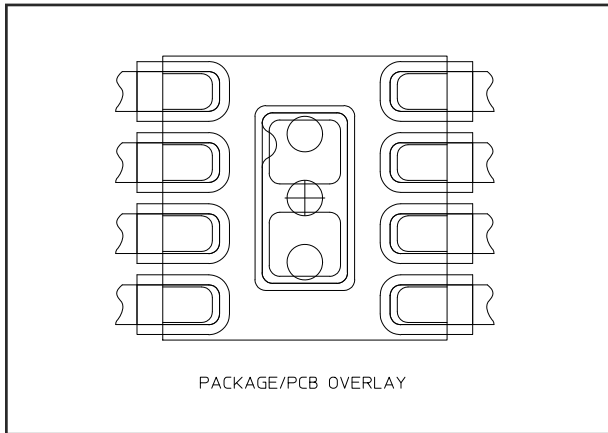
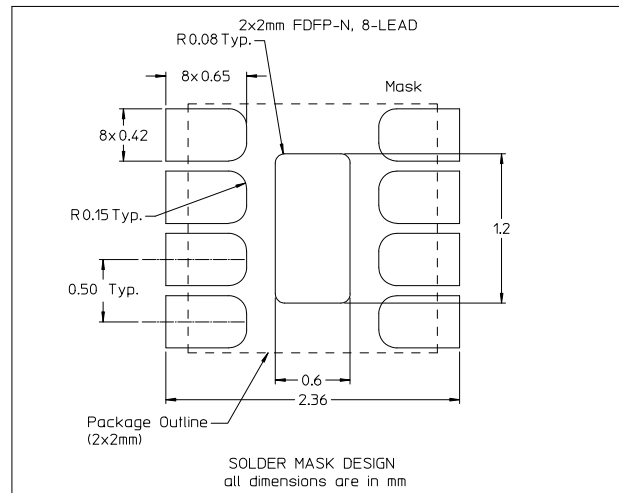
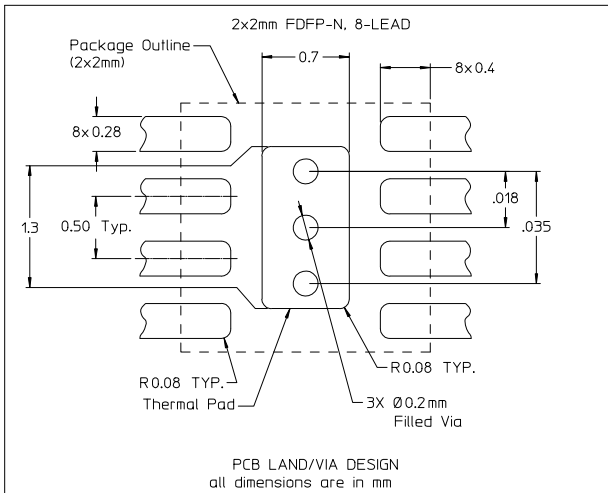

### Lead Free 2 mm 8-lead PDFN<sup>†</sup>

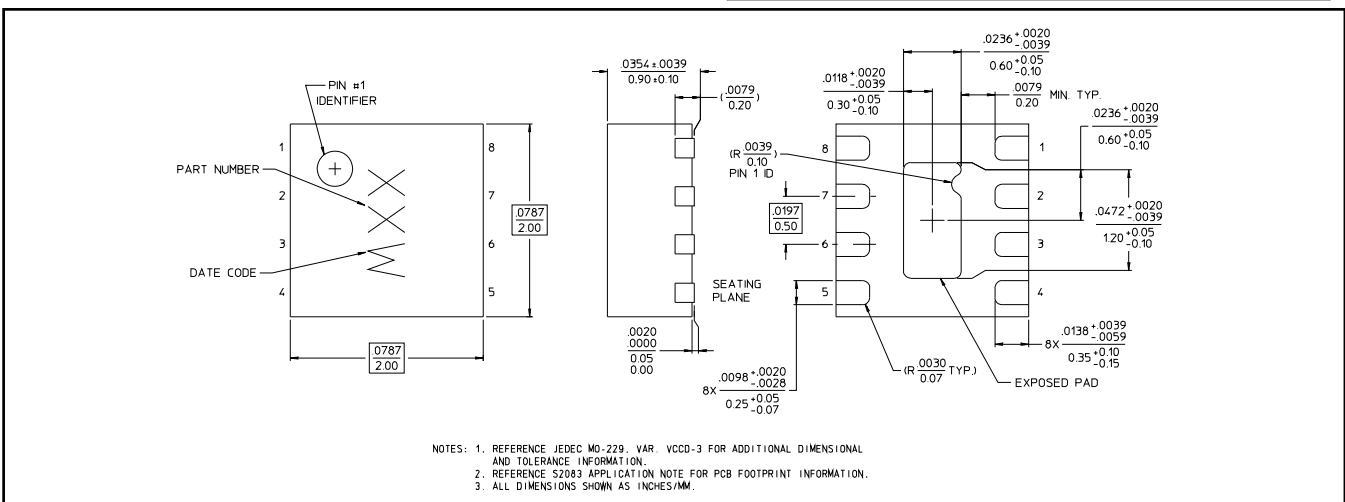

<sup>†</sup> Reference Application Note S2083 for lead-free solder reflow recommendations.  
Meets JEDEC moisture sensitivity level 1 requirements.  
Plating is 100% matte tin over copper.

**ADVANCED:** Data Sheets contain information regarding a product M/A-COM Technology Solutions is considering for development. Performance is based on target specifications, simulated results, and/or prototype measurements. Commitment to develop is not guaranteed.  
**PRELIMINARY:** Data Sheets contain information regarding a product M/A-COM Technology Solutions has under development. Performance is based on engineering tests. Specifications are typical. Mechanical outline has been fixed. Engineering samples and/or test data may be available. Commitment to produce in volume is not guaranteed.

- North America Tel: 800.366.2266 / Fax: 978.366.2266
- Europe Tel: 44.1908.574.200 / Fax: 44.1908.574.300
- Asia/Pacific Tel: 81.44.844.8296 / Fax: 81.44.844.8298

Visit [www.macomtech.com](http://www.macomtech.com) for additional data sheets and product information.

M/A-COM Technology Solutions Inc. and its affiliates reserve the right to make changes to the product(s) or information contained herein without notice.

Компания «Life Electronics» занимается поставками электронных компонентов импортного и отечественного производства от производителей и со складов крупных дистрибьюторов Европы, Америки и Азии.

С конца 2013 года компания активно расширяет линейку поставок компонентов по направлению коаксиальный кабель, кварцевые генераторы и конденсаторы (керамические, пленочные, электролитические), за счёт заключения дистрибьюторских договоров

Мы предлагаем:

- Конкурентоспособные цены и скидки постоянным клиентам.
- Специальные условия для постоянных клиентов.
- Подбор аналогов.
- Поставку компонентов в любых объемах, удовлетворяющих вашим потребностям.
- Приемлемые сроки поставки, возможна ускоренная поставка.
- Доставку товара в любую точку России и стран СНГ.
- Комплексную поставку.
- Работу по проектам и поставку образцов.
- Формирование склада под заказчика.
- Сертификаты соответствия на поставляемую продукцию (по желанию клиента).
- Тестирование поставляемой продукции.
- Поставку компонентов, требующих военную и космическую приемку.
- Входной контроль качества.
- Наличие сертификата ISO.

В составе нашей компании организован Конструкторский отдел, призванный помогать разработчикам, и инженерам.

Конструкторский отдел помогает осуществить:

- Регистрацию проекта у производителя компонентов.
- Техническую поддержку проекта.
- Защиту от снятия компонента с производства.
- Оценку стоимости проекта по компонентам.
- Изготовление тестовой платы монтаж и пусконаладочные работы.



Тел: +7 (812) 336 43 04 (многоканальный)

Email: [org@lifeelectronics.ru](mailto:org@lifeelectronics.ru)