

FEATURES

- Complies with ANSI TIA/EIA-485-A-1998 and ISO 8482: 1987(E)
- 250 kbps data rate
- ±4 kV HBM ESD protection on all pins
- Single 5 V ± 10% supply
- 7 V to +12 V bus common-mode range
- Connect up to 32 nodes on the bus
- Reduced slew rate for low EM interference
- Short-circuit protection
- 30 µA supply current

APPLICATIONS

- Low power RS-485 and RS-422 systems
- DTE-DCE interface
- Packet switching
- Local area networks
- Data concentration
- Data multiplexers
- Integrated services digital network (ISDN)

GENERAL DESCRIPTION

The [ADM488A](#) and [ADM489A](#) are low power, differential line transceivers suitable for communication on multipoint bus transmission lines. They are intended for balanced data transmission and comply with both RS-485 and RS-422 standards of the Electronics Industries Association (EIA). Both products contain a single differential line driver and a single differential line receiver, making them suitable for full-duplex data transfer. The [ADM489A](#) contains an additional receiver and driver enable control.

The input impedance is 12 kΩ, allowing 32 transceivers to be connected on the bus. The [ADM488A/ADM489A](#) operate from a single 5 V ± 10% power supply.

FUNCTIONAL BLOCK DIAGRAMS

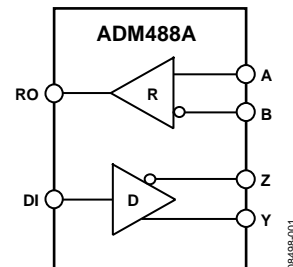

Figure 1. [ADM488A](#)

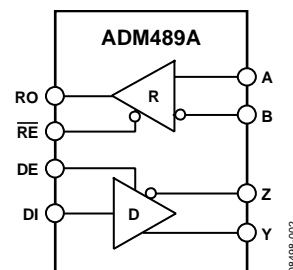

Figure 2. [ADM489A](#)

Excessive power dissipation that is caused by bus contention or output shorting is prevented by a thermal shutdown circuit. This feature forces the driver output into a high impedance state if, during fault conditions, a significant temperature increase is detected in the internal driver circuitry.

The receiver contains a fail-safe feature that results in a logic high output state if the inputs are unconnected (floating).

The [ADM488A/ADM489A](#) are fabricated on BiCMOS, an advanced mixed technology process combining low power CMOS with fast switching bipolar technology.

The [ADM488A/ADM489A](#) are fully specified over the industrial temperature range and are available in SOIC and MSOP packages.

TABLE OF CONTENTS

Features	1	Typical Performance Characteristics	8
Applications.....	1	Test Circuits.....	9
General Description	1	Switching Characteristics	10
Functional Block Diagrams.....	1	Theory of Operation	11
Revision History	2	Applications Information	13
Specifications.....	3	Differential Data Transmission	13
Timing Specifications	4	Cable and Data Rate.....	13
Absolute Maximum Ratings.....	5	Outline Dimensions	14
ESD Caution.....	5	Ordering Guide	15
Pin Configurations and Function Descriptions	6		

REVISION HISTORY

6/14—Rev. A to Rev. B

Changes to Features Section.....	1
Changes to Table 3.....	5

11/10—Rev. 0 to Rev. A

Changes to Table 2.....	4
Changes to Figure 20.....	11
Changes to Figure 21.....	12
Added New Figure 23, Renumbered Subsequent Figures, Moved Old Figure 23 to New Figure 25	14
Changes to Ordering Guide	15

10/09—Revision 0: Initial Version

SPECIFICATIONS

$V_{CC} = 5\text{ V} \pm 10\%$; all specifications T_{MIN} to T_{MAX} , unless otherwise noted.

Table 1.

Parameter	Symbol	Min	Typ	Max	Unit	Test Conditions/Comments
DRIVER						
Differential Output Voltage	V_{OD}			5.0	V	$R = \infty$, see Figure 11
		2.0		5.0	V	$V_{CC} = 5\text{ V}$, $R = 50\ \Omega$ (RS-422), see Figure 11
		1.5		5.0	V	$R = 27\ \Omega$ (RS-485), see Figure 11
		1.5		5.0	V	$V_{TST} = -7\text{ V to } +12\text{ V}$, see Figure 12, $V_{CC} = 5\text{ V} \pm 5\%$
$\Delta V_{OD} $ for Complementary Output States				0.2	V	$R = 27\ \Omega$ or $50\ \Omega$, see Figure 11
Common-Mode Output Voltage	V_{OC}			3.0	V	$R = 27\ \Omega$ or $50\ \Omega$, see Figure 11
$\Delta V_{OC} $ for Complementary Output States				0.2	V	$R = 27\ \Omega$ or $50\ \Omega$
Output Short-Circuit Current				250	mA	$-7\text{ V} \leq V_O \leq +12\text{ V}$
V_{OUT}						
CMOS Input Logic Threshold Low	V_{INL}		1.4	0.8	V	
CMOS Input Logic Threshold High	V_{INH}	2.0	1.4		V	
Logic Input Current (DE, DI)				± 1.0	μA	
RECEIVER						
Differential Input Threshold Voltage	V_{TH}	-0.2		+0.2	V	$-7\text{ V} \leq V_{CM} \leq +12\text{ V}$
Input Voltage Hysteresis	ΔV_{TH}		70		mV	$V_{CM} = 0\text{ V}$
Input Resistance		12			k Ω	$-7\text{ V} \leq V_{CM} \leq +12\text{ V}$
Input Current (A, B)				1	mA	$V_{IN} = 12\text{ V}$
				-0.8	mA	$V_{IN} = -7\text{ V}$
Logic Enable Input Current (\overline{RE})				± 1	μA	
CMOS Output Voltage Low	V_{OL}			0.4	V	$I_{OUT} = +4.0\text{ mA}$
CMOS Output Voltage High	V_{OH}	4.0			V	$I_{OUT} = -4.0\text{ mA}$
Short-Circuit Output Current		7		85	mA	$V_{OUT} = \text{GND or } V_{CC}$
Three-State Output Leakage Current				± 1.0	μA	$0.4\text{ V} \leq V_{OUT} \leq 2.4\text{ V}$
POWER SUPPLY CURRENT						
	I_{CC}		30	60	μA	Outputs unloaded, receivers enabled
			37	74	μA	DE = 0 V (disabled)
						DE = 5 V (enabled)

TIMING SPECIFICATIONS

$V_{CC} = 5\text{ V} \pm 10\%$. All specifications T_{MIN} to T_{MAX} , unless otherwise noted.

Table 2.

Parameter	Symbol	Min	Typ	Max	Unit	Test Conditions/Comments
DRIVER						
Propagation Delay Input to Output	t_{PLH}, t_{PHL}	250		2000	ns	R_L differential = 54 Ω , $C_{L1} = C_{L2} = 100$ pF, see Figure 15, Figure 16
Driver Output Skew	t_{SKEW}		100	800	ns	R_L differential = 54 Ω , $C_{L1} = C_{L2} = 100$ pF, see Figure 15
Driver Rise/Fall Time	t_{DR}, t_{DF}	250		2000	ns	R_L differential = 54 Ω , $C_{L1} = C_{L2} = 100$ pF, see Figure 15, Figure 16
Driver Enable to Output Valid	t_{ZL}, t_{ZH}	250		2000	ns	$R_L = 500$ Ω , $C_L = 100$ pF, see Figure 12, Figure 18
Driver Disable Timing	t_{LZ}, t_{HZ}	300		3000	ns	$R_L = 500$ Ω , $C_L = 15$ pF, see Figure 12, Figure 18
Maximum Data Rate		250			kbps	
RECEIVER						
Propagation Delay Input to Output	t_{PLH}, t_{PHL}	250		2000	ns	$C_L = 15$ pF, see Figure 15, Figure 17
Skew	$ t_{PLH} - t_{PHL} $		100		ns	
Receiver Enable	t_{EN1}		10	50	ns	$R_L = 1$ k Ω , $C_L = 15$ pF, see Figure 14, Figure 19
Receiver Disable	t_{EN2}		10	50	ns	$R_L = 1$ k Ω , $C_L = 15$ pF, see Figure 14, Figure 19
Maximum Data Rate		250			kbps	

ABSOLUTE MAXIMUM RATINGS

$T_A = 25^\circ\text{C}$, unless otherwise noted.

Table 3.

Parameter	Rating
V_{CC}	7 V
Inputs	
Driver Input (DI)	$-0.3\text{ V to }V_{CC} + 0.3\text{ V}$
Control Inputs (DE, $\overline{\text{RE}}$)	$-0.3\text{ V to }V_{CC} + 0.3\text{ V}$
Receiver Inputs (A, B)	$-14\text{ V to }+14\text{ V}$
Outputs	
Driver Outputs	$-14\text{ V to }+12.5\text{ V}$
Receiver Output	$-0.5\text{ V to }V_{CC} + 0.5\text{ V}$
Power Dissipation 8-Lead SOIC	520 mW
θ_{JA} , Thermal Impedance	110°C/W
Power Dissipation 14-Lead SOIC	800 mW
θ_{JA} , Thermal Impedance	120°C/W
Operating Temperature Range	
Industrial (A Version)	$-40^\circ\text{C to }+85^\circ\text{C}$
Storage Temperature Range	$-65^\circ\text{C to }+150^\circ\text{C}$
Lead Temperature (Soldering, 10 sec)	300°C
Vapor Phase (60 sec)	215°C
Infrared (15 sec)	220°C
ESD Protection on All Pins	
Human Body Model (HBM)	$\pm 4\text{ kV}$

Stresses above those listed under Absolute Maximum Ratings may cause permanent damage to the device. This is a stress rating only; functional operation of the device at these or any other conditions above those indicated in the operational section of this specification is not implied. Exposure to absolute maximum rating conditions for extended periods may affect device reliability.

ESD CAUTION



ESD (electrostatic discharge) sensitive device. Charged devices and circuit boards can discharge without detection. Although this product features patented or proprietary protection circuitry, damage may occur on devices subjected to high energy ESD. Therefore, proper ESD precautions should be taken to avoid performance degradation or loss of functionality.

PIN CONFIGURATIONS AND FUNCTION DESCRIPTIONS

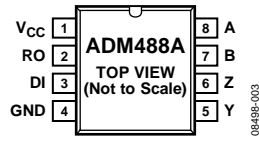

Figure 3. ADM488A SOIC_N and MSOP Pin Configuration

Table 4. ADM488A Pin Function Descriptions

Pin No.	Mnemonic	Description
1	V _{CC}	Power Supply, 5 V ± 10%.
2	RO	Receiver Output. When A > B by 200 mV, RO = high. If A < B by 200 mV, RO = low.
3	DI	Driver Input. A logic low on DI forces Y low and Z high, whereas a logic high on DI forces Y high and Z low.
4	GND	Ground Connection, 0 V.
5	Y	Noninverting Driver, Differential Output Y.
6	Z	Inverting Driver, Differential Output Z.
7	B	Inverting Receiver, Input B.
8	A	Noninverting Receiver, Input A.

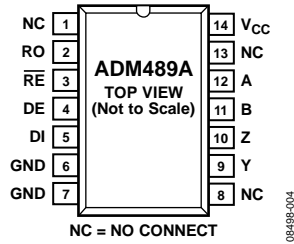

Figure 4. ADM489A SOIC_N Pin Configuration

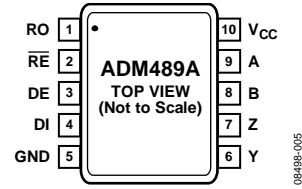

Figure 5. ADM489A MSOP Pin Configuration

Table 5. ADM489A Pin Function Descriptions

Pin No.		Mnemonic	Description
SOIC_N	MSOP		
1, 8, 13	N/A ¹	NC	No Connect. No connections are required to this pin.
2	1	RO	Receiver Output. When enabled, if A > B by 200 mV, RO = high. If A < B by 200 mV, RO = low.
3	2	RE	Receiver Output Enable. A low level enables the receiver output, RO. A high level places the ADM489A in a high impedance state.
4	3	DE	Driver Output Enable. A high level enables the driver differential outputs (Y and Z). A low level places the ADM489A in a high impedance state.
5	4	DI	Driver Input. When the driver is enabled, a logic low on DI forces Y low and Z high, whereas a logic high on DI forces Y high and Z low.
6, 7	5	GND	Ground Connection, 0 V.
9	6	Y	Noninverting Driver, Differential Output Y.
10	7	Z	Inverting Driver, Differential Output Z.
11	8	B	Inverting Receiver, Input B.
12	9	A	Noninverting Receiver, Input A.
14	10	V _{CC}	Power Supply, 5 V ± 10%.

¹ N/A means not applicable.

TYPICAL PERFORMANCE CHARACTERISTICS

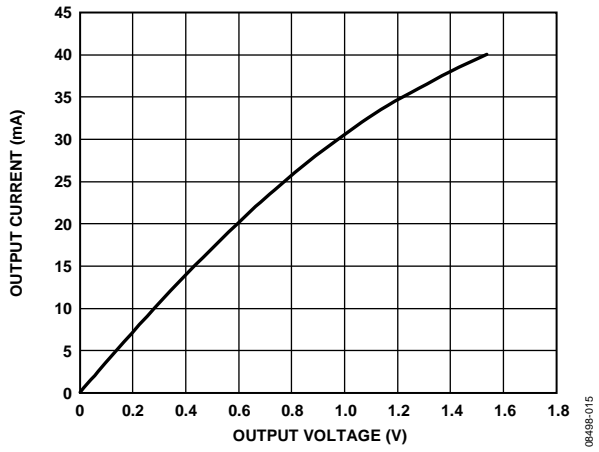

Figure 6. Output Current vs. Receiver Output Low Voltage

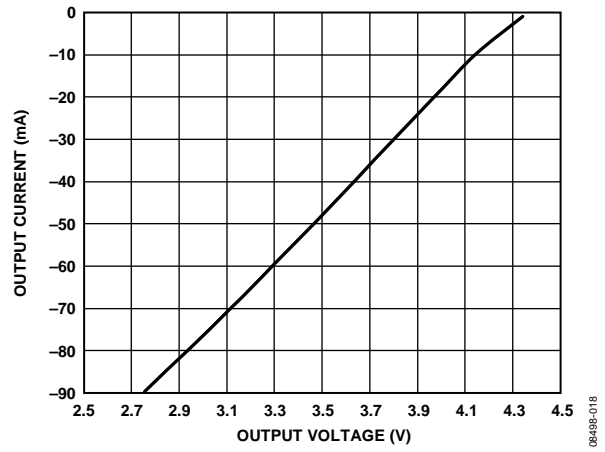

Figure 9. Output Current vs. Driver Output High Voltage

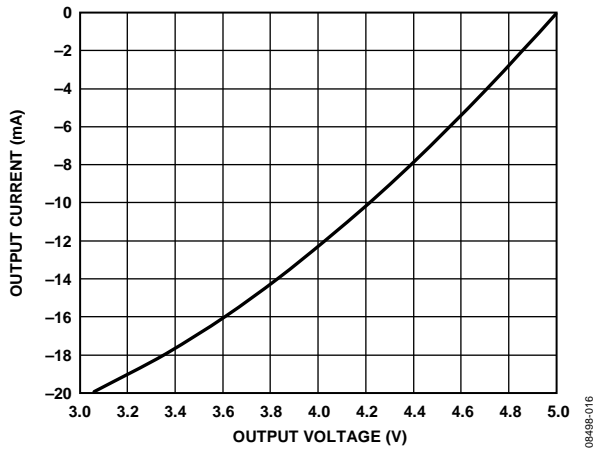

Figure 7. Output Current vs. Receiver Output High Voltage

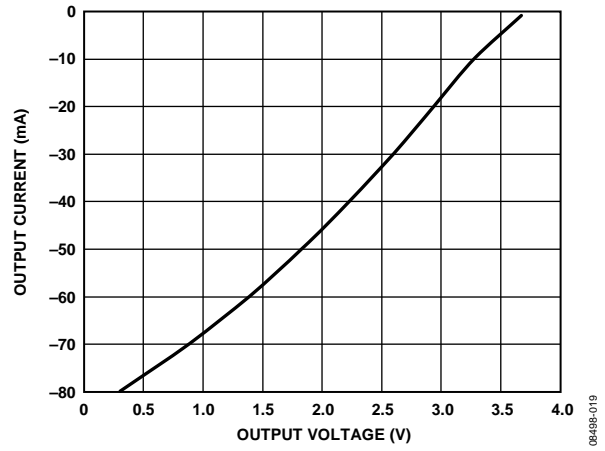

Figure 10. Output Current vs. Driver Differential Output Voltage

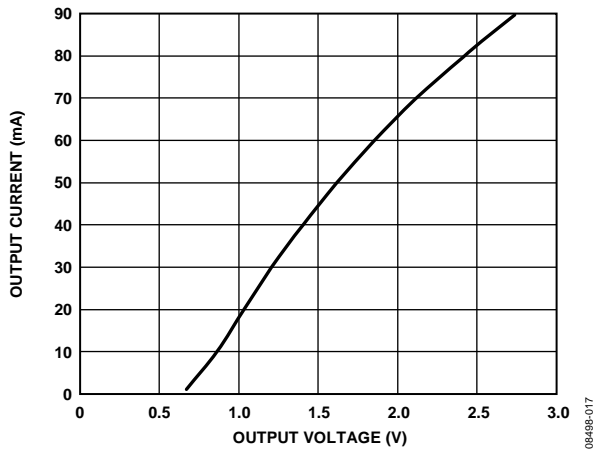

Figure 8. Output Current vs. Driver Output Low Voltage

TEST CIRCUITS

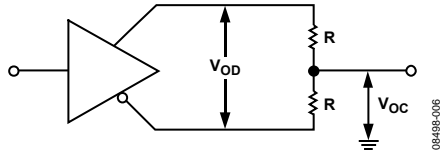

Figure 11. Driver Voltage Measurement Test Circuit

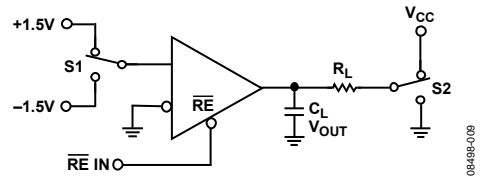

Figure 14. Receiver Enable/Disable Test Circuit

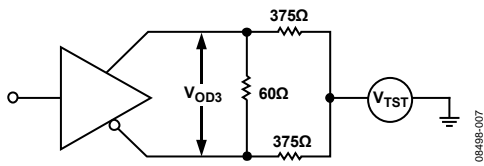

Figure 12. Driver Enable/Disable Test Circuit

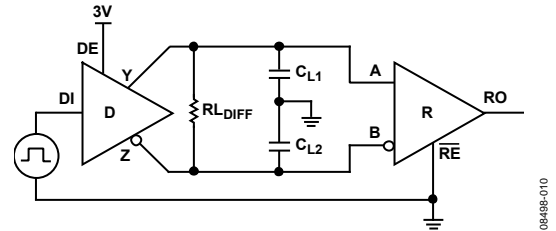

Figure 15. Driver/Receiver Propagation Delay Test Circuit

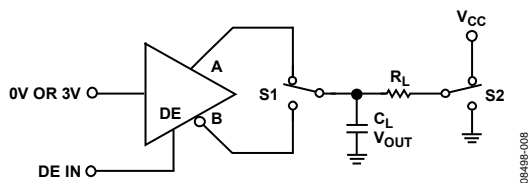

Figure 13. Driver Voltage Measurement Test Circuit

SWITCHING CHARACTERISTICS

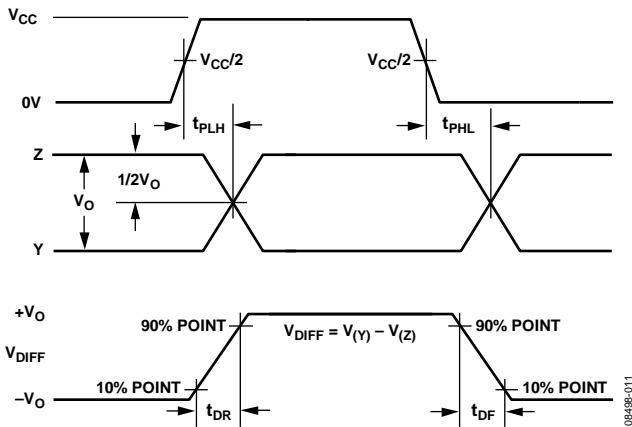

Figure 16. Driver Propagation Delay, Rise/Fall Timing

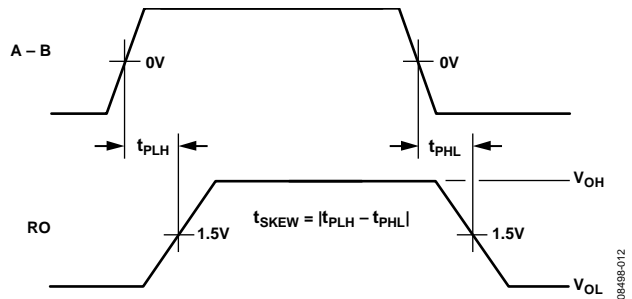

Figure 17. Receiver Propagation Delay

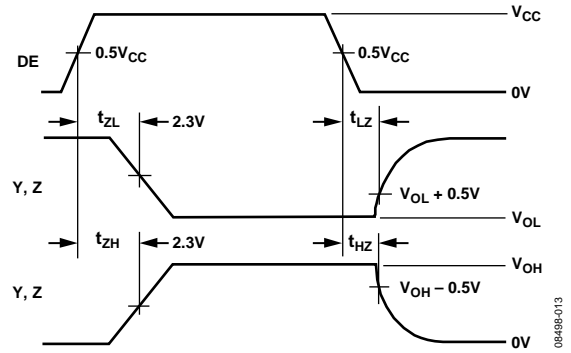

Figure 18. Driver Enable/Disable Timing

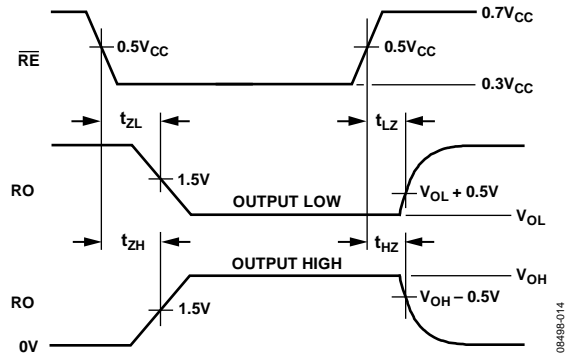

Figure 19. Receiver Enable/Disable Timing

THEORY OF OPERATION

The ADM488A/ADM489A are ruggedized RS-485 transceivers that operate from a single 5 V supply. They contain protection against radiated and conducted interference and are ideally suited for operation in electrically harsh environments or where cables can be plugged/unplugged. They are also immune to high RF field strengths without special shielding precautions.

The ADM488A/ADM489A are intended for balanced data transmission and comply with both EIA RS-485 and RS-422 standards. They contain a differential line driver and a differential line receiver, and are suitable for full-duplex data transmission.

The input impedance on the ADM488A/ADM489A is 12 k Ω , allowing up to 32 transceivers on the differential bus. The ADM488A/ADM489A operate from a single 5 V \pm 10% power supply. A thermal shutdown circuit prevents excessive power dissipation caused by bus contention or by output shorting. This feature forces the driver output into a high impedance state if, during fault conditions, a significant temperature increase is detected in the internal driver circuitry.

The receiver contains a fail-safe feature that results in a logic high output state if the inputs are unconnected (floating).

The ADM488A/ADM489A can transmit at data rates up to 250 kbps. Figure 20 shows a typical application for the ADM488A/ADM489A, a full-duplex link where data transfers at rates of up to 250 kbps. A terminating resistor is shown at both ends of the link. This termination is not critical because

the slew rate is controlled by the ADM488A/ADM489A and reflections are minimized.

The communications network can be extended to include multipoint connections, as shown in Figure 22. As many as 32 transceivers can be connected to the bus.

Table 6 and Table 7 show the truth tables for transmitting and receiving.

Table 6. Transmitting Truth Table

Inputs			Outputs	
RE	DE	DI	Z	Y
X ¹	1	1	0	1
X ¹	1	0	1	0
0	0	X ¹	High-Z	High-Z
1	0	X ¹	High-Z	High-Z

¹ X is don't care.

Table 7. Receiving Truth Table

Inputs			Output
RE	DE	A to B	RO
0	0	$\geq +0.2$ V	1
0	0	≤ -0.2 V	0
0	0	Inputs open circuit	1
1	0	X ¹	High-Z

¹ X is don't care.

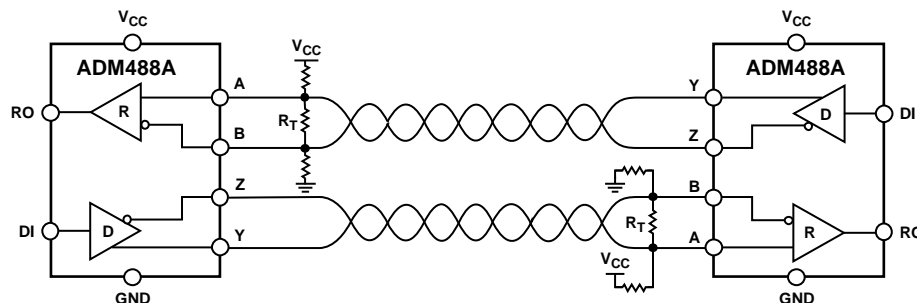

NOTES
1. MAXIMUM NUMBER OF NODES = 32.

Figure 20. ADM488A/ADM489A Full-Duplex Data Link

084488-021

MAXIMUM NUMBER OF NODES = 32

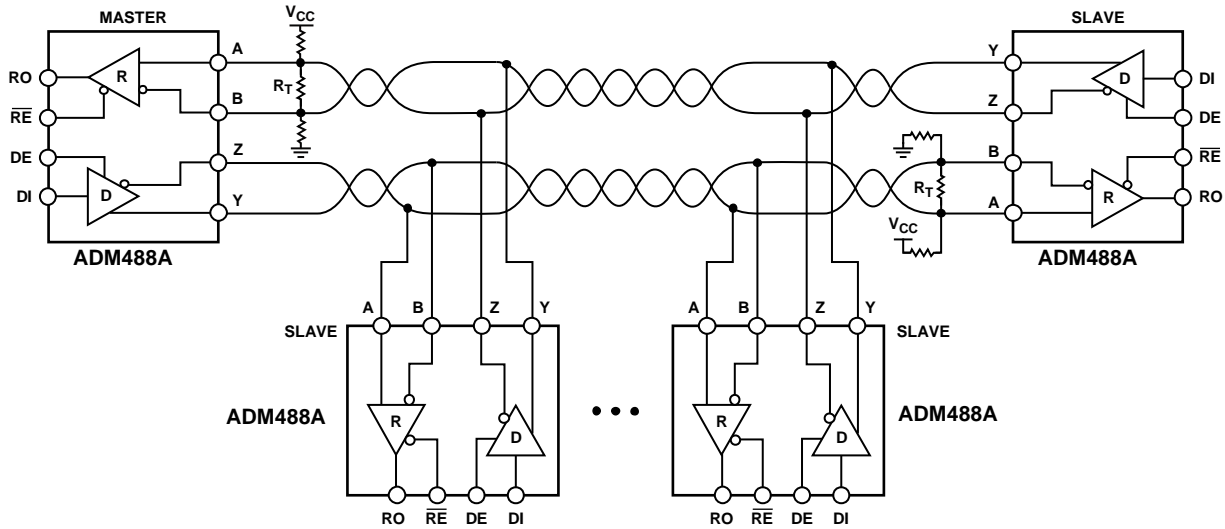

NOTES
 1. R_T IS EQUAL TO THE CHARACTERISTIC IMPEDANCE OF THE CABLE.

Figure 21. Typical RS-485 Full-Duplex Application

08488-023

APPLICATIONS INFORMATION

DIFFERENTIAL DATA TRANSMISSION

Differential data transmission reliably transmits data at high rates over long distances and through noisy environments. Differential transmission nullifies the effects of ground shifts and noise signals, which appear as common-mode voltages on the line. Two main standards that specify the electrical characteristics of transceivers used in differential data transmission are approved by the EIA.

The RS-422 standard specifies data rates up to 10 Mbps and line lengths up to 4000 ft. A single driver can drive a transmission line with up to 10 receivers.

To cater to true multipoint communications, the RS-485 standard was defined to meet or exceed the requirements of RS-422. It also allows up to 32 drivers and 32 receivers to be connected to a single bus. An extended common-mode range of -7 V to $+12\text{ V}$ is defined. The most significant difference between the RS-422 and RS-485 is that the RS-485 drivers can be disabled, thereby allowing up to 32 receivers to be connected to a single line. Only one driver should be enabled at a time, but the RS-485 standard contains additional specifications to guarantee device safety in the event of line contention.

CABLE AND DATA RATE

The transmission line of choice for RS-485 communications is a twisted pair. Twisted pair cable tends to cancel common-mode noise and causes cancellation of the magnetic fields generated by the current flowing through each wire, thereby reducing the effective inductance of the pair.

The ADM488A/ADM489A are designed for bidirectional data communications on multipoint transmission lines. A typical application with a multipoint transmission network is illustrated in Figure 22. An RS-485 transmission line can have up to 32 transceivers on the bus. Only one driver can transmit at a particular time, but multiple receivers can be simultaneously enabled.

As with any transmission line, it is important to minimize reflections. This can be achieved by terminating the extreme ends of the line using resistors equal to the characteristic impedance of the line. Keep stub lengths of the main line as short as possible. A properly terminated transmission line appears purely resistive to the driver.

Table 8. Comparison of RS-422 and RS-485 Interface Standards

Specification	RS-422	RS-485
Transmission Type	Differential	Differential
Maximum Data Rate	10 Mbps	10 Mbps
Maximum Cable Length	4000 ft.	4000 ft.
Minimum Driver Output Voltage	$\pm 2\text{ V}$	$\pm 1.5\text{ V}$
Driver Load Impedance	$100\ \Omega$	$54\ \Omega$
Receiver Input Resistance	4 k Ω minimum	12 k Ω minimum
Receiver Input Sensitivity	$\pm 200\text{ mV}$	$\pm 200\text{ mV}$
Receiver Input Voltage Range	-7 V to $+7\text{ V}$	-7 V to $+12\text{ V}$
Number of Drivers/Receivers per Line	1/10	32/32

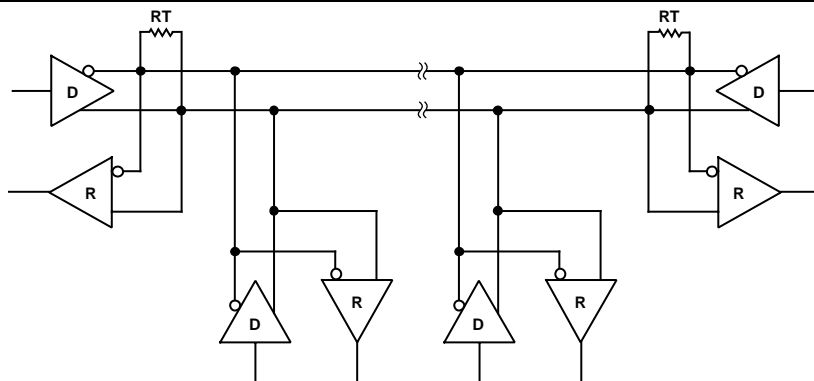
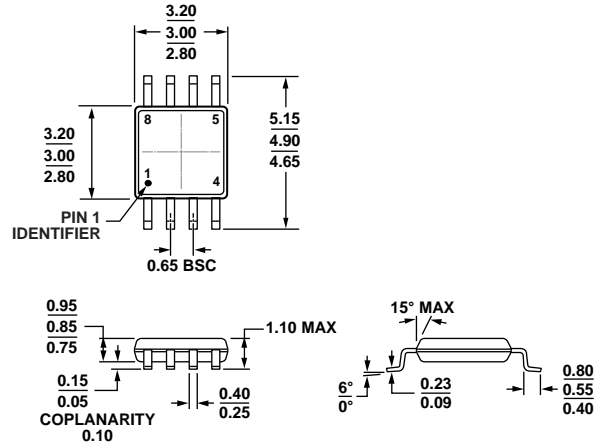

Figure 22. Typical RS-485 Network

09488-022

OUTLINE DIMENSIONS



COMPLIANT TO JEDEC STANDARDS MO-187-AA
 Figure 23. 8-Lead Mini Small Outline Package [MSOP]
 (RM-8)
 Dimensions shown in millimeters

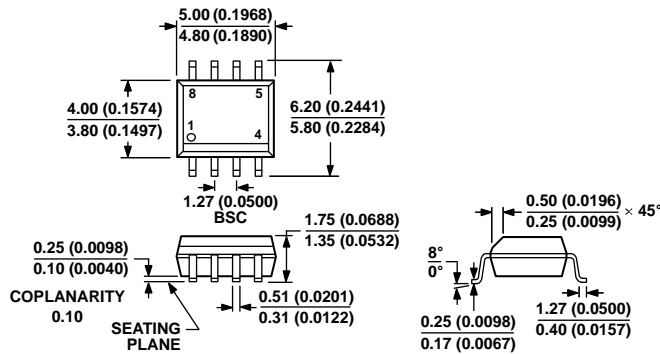

COMPLIANT TO JEDEC STANDARDS MS-012-AA
 CONTROLLING DIMENSIONS ARE IN MILLIMETERS; INCH DIMENSIONS
 (IN PARENTHESES) ARE ROUNDED-OFF MILLIMETER EQUIVALENTS FOR
 REFERENCE ONLY AND ARE NOT APPROPRIATE FOR USE IN DESIGN.
 Figure 24. 8-Lead Standard Small Outline Package [SOIC_N]
 Narrow Body
 (R-8)
 Dimensions shown in millimeters and (inches)

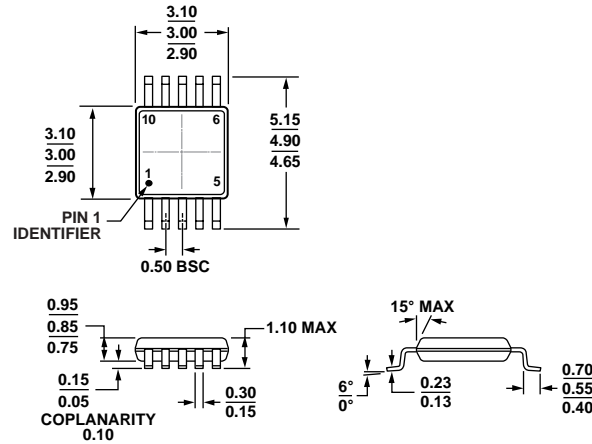

COMPLIANT TO JEDEC STANDARDS MO-187-BA

Figure 25. 10-Lead Mini Small Outline Package [MSOP] (RM-10)

Dimensions shown in millimeters

001708-A

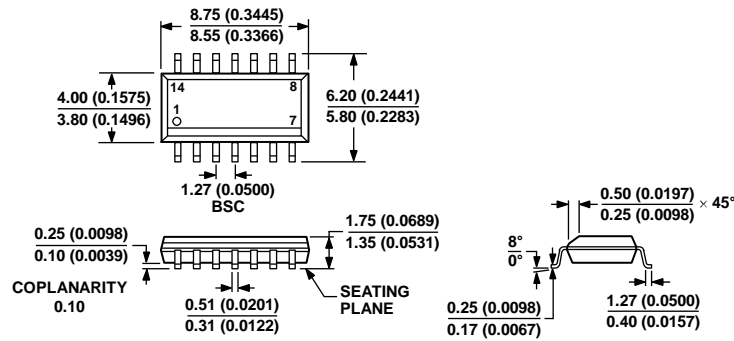

COMPLIANT TO JEDEC STANDARDS MS-012-AB

CONTROLLING DIMENSIONS ARE IN MILLIMETERS; INCH DIMENSIONS (IN PARENTHESES) ARE ROUNDED-OFF MILLIMETER EQUIVALENTS FOR REFERENCE ONLY AND ARE NOT APPROPRIATE FOR USE IN DESIGN.

Figure 26. 14-Lead Standard Small Outline Package [SOIC_N] Narrow Body (R-14)

Dimensions shown in millimeters and (inches)

060608-A

ORDERING GUIDE

Model ¹	Temperature Range	Package Description	Package Option	Branding
ADM488ABRMZ	-40°C to +85°C	8-Lead Mini Small Outline Package [MSOP]	RM-8	FOF
ADM488ABRMZ-REEL7	-40°C to +85°C	8-Lead Mini Small Outline Package [MSOP]	RM-8	FOF
ADM488ABRZ	-40°C to +85°C	8-Lead Standard Small Outline Package, Narrow Body [SOIC_N]	R-8	
ADM488ABRZ-REEL7	-40°C to +85°C	8-Lead Standard Small Outline Package, Narrow Body [SOIC_N]	R-8	
ADM489ABRMZ	-40°C to +85°C	10-Lead Mini Small Outline Package [MSOP]	RM-10	FOG
ADM489ABRMZ-REEL7	-40°C to +85°C	10-Lead Mini Small Outline Package [MSOP]	RM-10	FOG
ADM489ABRZ	-40°C to +85°C	14-Lead Standard Small Outline Package, Narrow Body [SOIC_N]	R-14	
ADM489ABRZ-REEL7	-40°C to +85°C	14-Lead Standard Small Outline Package, Narrow Body [SOIC_N]	R-14	

¹ Z = RoHS Compliant Part.

NOTES

Компания «Life Electronics» занимается поставками электронных компонентов импортного и отечественного производства от производителей и со складов крупных дистрибьюторов Европы, Америки и Азии.

С конца 2013 года компания активно расширяет линейку поставок компонентов по направлению коаксиальный кабель, кварцевые генераторы и конденсаторы (керамические, пленочные, электролитические), за счёт заключения дистрибьюторских договоров

Мы предлагаем:

- Конкурентоспособные цены и скидки постоянным клиентам.
- Специальные условия для постоянных клиентов.
- Подбор аналогов.
- Поставку компонентов в любых объемах, удовлетворяющих вашим потребностям.
- Приемлемые сроки поставки, возможна ускоренная поставка.
- Доставку товара в любую точку России и стран СНГ.
- Комплексную поставку.
- Работу по проектам и поставку образцов.
- Формирование склада под заказчика.
- Сертификаты соответствия на поставляемую продукцию (по желанию клиента).
- Тестирование поставляемой продукции.
- Поставку компонентов, требующих военную и космическую приемку.
- Входной контроль качества.
- Наличие сертификата ISO.

В составе нашей компании организован Конструкторский отдел, призванный помогать разработчикам, и инженерам.

Конструкторский отдел помогает осуществить:

- Регистрацию проекта у производителя компонентов.
- Техническую поддержку проекта.
- Защиту от снятия компонента с производства.
- Оценку стоимости проекта по компонентам.
- Изготовление тестовой платы монтаж и пусконаладочные работы.



Тел: +7 (812) 336 43 04 (многоканальный)

Email: org@lifeelectronics.ru