

Micropower quad CMOS voltage comparators

Datasheet - production data

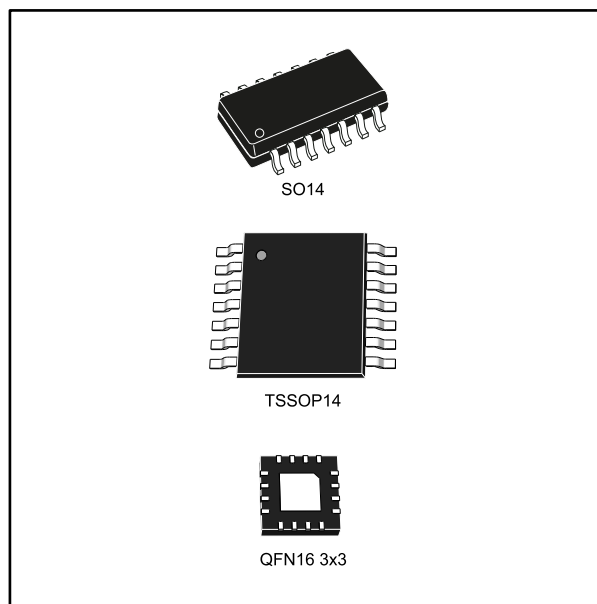

Related products

- Pin-to-pin and functionally compatible with the dual CMOS TS3704 comparators
- See TSX339 for open drain output

Applications

- Automotive
- Industrial

Description

The TSX3704 is a micropower CMOS quad voltage comparator which exhibits a very low current consumption of 5 μ A typical per comparator. This device was designed as the improvement of the TS3704: it shows a lower current consumption, a better input offset voltage, and an enhanced ESD tolerance. The TSX3704 is fully specified over a wide temperature range and is proposed in automotive grade for the TSSOP14 package. It is fully compatible with the TS3704 CMOS comparator and is available with similar packages. The new tiny package, QFN16 3x3, is also proposed for the TSX3704 thus allowing even more integration on applications.

Features

- Low supply current: 5 μ A typ. per comparator
- Wide single supply range 2.7 V to 16 V or dual supplies (± 1.35 V to ± 8 V)
- Extremely low input bias current: 1 pA typ.
- Input common-mode voltage range includes ground
- Push-pull output
- High input impedance: 10^{12} Ω typ
- Fast response time: 2.7 μ s typ. for 5 mV overdrive
- ESD tolerance: 4 kV HBM, 200 V MM

Contents

1 Schematic diagram..... 3

2 Package pin connections..... 4

3 Absolute maximum ratings and operating conditions 5

4 Electrical characteristics 6

5 Electrical characteristic curves 10

6 Application information 13

 6.1 Input voltages..... 13

 6.2 For unused channel 14

 6.3 Bypass capacitor..... 14

7 Package information 15

 7.1 SO14 package information..... 16

 7.2 TSSOP14 package information..... 17

 7.3 QFN16 3x3 package information..... 18

8 Ordering information..... 20

9 Revision history 21

1 Schematic diagram

Figure 1: Schematic diagram (one operator)

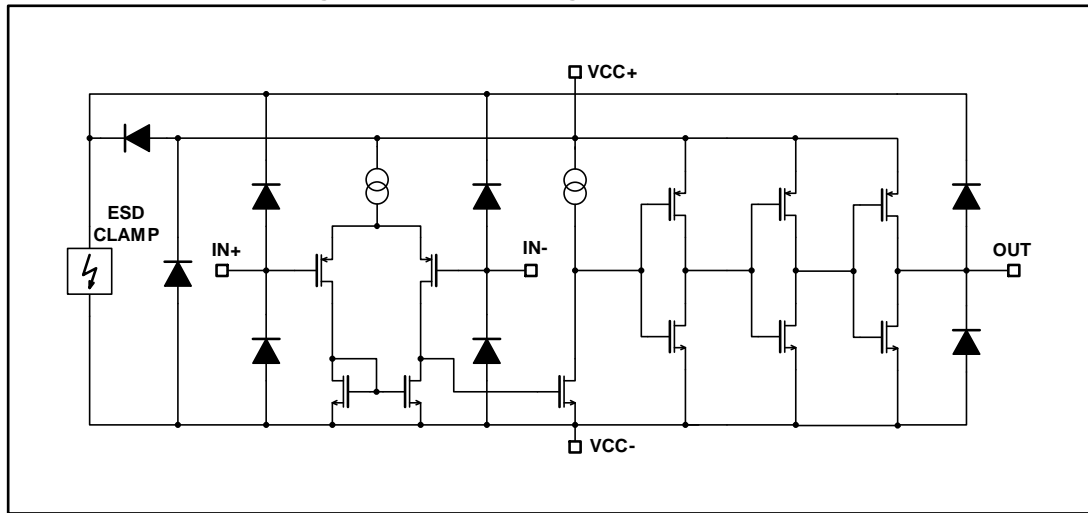

2 Package pin connections

Figure 2: Pin connections (top view)

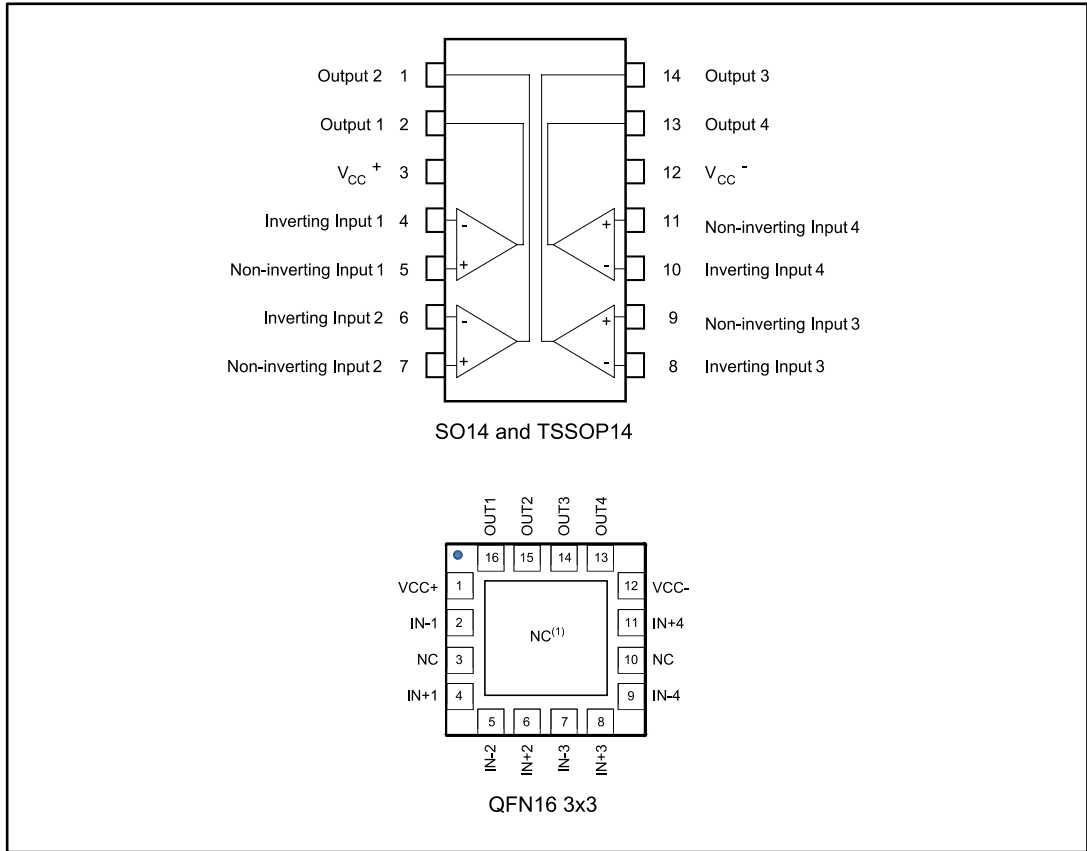

1. NC = not connected
2. The exposed pad of the QFN16 3x3 can be connected to VCC- or left floating.

3 Absolute maximum ratings and operating conditions

Table 1: Absolute maximum ratings (AMR)

| Symbol | Parameter | Value | Unit | |
|------------|---|------------|------|------|
| V_{CC}^+ | Supply voltage ⁽¹⁾ | 18 | V | |
| V_{id} | Differential input voltage ⁽²⁾ | ±18 | | |
| V_{in} | Input voltage | -0.3 to 18 | | |
| V_o | Output voltage | 18 | | |
| I_o | Output current | 20 | mA | |
| I_F | Forward current in ESD protection diodes on inputs ⁽³⁾ | 50 | | |
| T_j | Maximum junction temperature | 150 | °C | |
| T_{stg} | Storage temperature range | -65 to 150 | | |
| R_{thja} | Thermal resistance junction to ambient ⁽⁴⁾ | SO14 | 105 | °C/W |
| | | TSSOP14 | 100 | |
| | | QFN16 3x3 | 39 | |
| ESD | HBM: human body model ⁽⁵⁾ | 4000 | V | |
| | MM: machine model ⁽⁶⁾ | 200 | | |
| | CDM: charged device model ⁽⁷⁾ | 1500 | | |
| | Latch-up immunity | 200 | mA | |

Notes:

- ⁽¹⁾All voltage values, except the differential voltage, are with respect to network ground terminal
⁽²⁾Differential voltages are the non-inverting input terminal with respect to the inverting input terminal
⁽³⁾Guaranteed by design
⁽⁴⁾Short-circuits can cause excessive heating and destructive dissipation. Values are typical
⁽⁵⁾According to JEDEC standard JESD22-A114F
⁽⁶⁾According to JEDEC standard JESD22-A115A
⁽⁷⁾According to ANSI/ESD STM5.3.1

Table 2: Operating conditions

| Symbol | Parameter | Value | Unit |
|-----------------|--------------------------------------|-------------------------|------|
| V_{CC}^+ | Supply voltage | 2.7 to 16 | V |
| $V_{icm}^{(1)}$ | Common mode input voltage range | 0 to $(V_{CC}^+) - 1.5$ | |
| | $T_{min} \leq T_{amb} \leq T_{max}$ | 0 to $(V_{CC}^+) - 2$ | |
| T_{oper} | Operating free-air temperature range | -40 to 125 | °C |

Notes:

- ⁽¹⁾The output state is guaranteed as long as one input remains with this common mode input voltage range, and the other input remains between -0.3 V and 16 V (meaning that one input can be driven above V_{CC}^+).

4 Electrical characteristics

Table 3: $V_{CC+} = 3\text{ V}$, $V_{CC-} = 0\text{ V}$, $T_{amb} = 25\text{ }^{\circ}\text{C}$ (unless otherwise specified)

| Symbol | Parameter | Condition | Min. | Typ. | Max. | Unit |
|-----------|-------------------------------------|---|------|------|------|------|
| V_{io} | Input offset voltage ⁽¹⁾ | $V_{icm} = 0\text{ V}$ | -5 | 0.1 | 5 | mV |
| | | $T_{min} \leq T_{amb} \leq T_{max}$ | -6 | | 6 | |
| I_{io} | Input offset current ⁽²⁾ | $V_{icm} = V_{CC}/2$ | | 1 | 10 | pA |
| | | $T_{min} \leq T_{amb} \leq T_{max}$ | | | 600 | |
| I_{ib} | Input bias current ⁽²⁾ | $V_{icm} = V_{CC}/2$ | | 1 | 10 | |
| | | $T_{min} \leq T_{amb} \leq T_{max}$ | | | 1200 | |
| CMR | Common-mode rejection ratio | $V_{icm} = 0\text{ to max } V_{icm}$ | 58 | 73 | | dB |
| | | $T_{min} \leq T_{amb} \leq T_{max}$ | 55 | | | |
| SVR | Supply voltage rejection ratio | $V_{CC+} = 3\text{ V to } 5\text{ V}$, $V_{icm} = V_{CC}/2$ | 69 | 88 | | |
| | | $T_{min} \leq T_{amb} \leq T_{max}$ | 69 | | | |
| V_{OH} | High-level output voltage drop | $V_{id} = 1\text{ V}$, $I_{OH} = 4\text{ mA}$ | | 300 | 400 | mV |
| | | $T_{min} \leq T_{amb} \leq T_{max}$ | | | 600 | |
| V_{OL} | Low-level output voltage | $V_{id} = -1\text{ V}$, $I_{OL} = 4\text{ mA}$ | | 300 | 400 | mV |
| | | $T_{min} \leq T_{amb} \leq T_{max}$ | | | 600 | |
| I_{CC} | Supply current per comparator | No load - outputs low | | 5 | 6 | μA |
| | | $T_{min} \leq T_{amb} \leq T_{max}$ | | | 7 | |
| | | No load - outputs high | | 8 | 9 | |
| | | $T_{min} \leq T_{amb} \leq T_{max}$ | | | 11 | |
| t_{PLH} | Response time low to high | $V_{icm} = 0\text{ V}$, $f = 10\text{ kHz}$, $R_L = 5.1\text{ k}\Omega$, $C_L = 50\text{ pF}$, overdrive = 5 mV | | 2.4 | | μs |
| | | Overdrive = 100 mV | | 0.5 | 0.6 | |
| | | $T_{min} \leq T_{amb} \leq T_{max}$ | | | 0.77 | |
| t_{PHL} | Response time high to low | $V_{icm} = 0\text{ V}$, $f = 10\text{ kHz}$, $R_L = 5.1\text{ k}\Omega$, $C_L = 50\text{ pF}$, overdrive = 5 mV | | 2 | | μs |
| | | Overdrive = 100 mV | | 0.45 | 0.6 | |
| | | $T_{min} \leq T_{amb} \leq T_{max}$ | | | 0.65 | |
| t_r | Rise time | $f = 10\text{ kHz}$, $C_L = 50\text{ pF}$, $R_L = 5.1\text{ k}\Omega$, overdrive 50 mV | | 39 | | ns |
| t_f | Fall time | $f = 10\text{ kHz}$, $C_L = 50\text{ pF}$, $R_L = 5.1\text{ k}\Omega$, overdrive 50 mV | | 39 | | |

Notes:

⁽¹⁾The specified offset voltage is the maximum value required to drive the output up to 2.5 V or down to 0.3 V.

⁽²⁾Guaranteed by design.

Table 4: VCC+ = 5 V, VCC- = 0 V, Tamb = 25 °C (unless otherwise specified)

| Symbol | Parameter | Condition | Min. | Typ. | Max. | Unit |
|------------------|-------------------------------------|---|------|------|------|------|
| V _{io} | Input offset voltage ⁽¹⁾ | V _{icm} = V _{CC} /2 | -5 | 0.1 | 5 | mV |
| | | T _{min} ≤ T _{amb} ≤ T _{max} | -6 | | 6 | |
| I _{io} | Input offset current ⁽²⁾ | V _{icm} = V _{CC} /2 | | 1 | 10 | pA |
| | | T _{min} ≤ T _{amb} ≤ T _{max} | | | 600 | |
| I _{ib} | Input bias current ⁽²⁾ | V _{icm} = V _{CC} /2 | | 1 | 10 | |
| | | T _{min} ≤ T _{amb} ≤ T _{max} | | | 1200 | |
| CMR | Common-mode rejection ratio | V _{icm} = 0 to max V _{icm} | 66 | 85 | | dB |
| | | T _{min} ≤ T _{amb} ≤ T _{max} | 65 | | | |
| SVR | Supply voltage rejection ratio | V _{CC} ⁺ = 5 V to 10 V, V _{icm} = V _{CC} /2 | 71 | 89 | | |
| | | T _{min} ≤ T _{amb} ≤ T _{max} | 70 | | | |
| V _{OH} | High-level output voltage drop | V _{id} = 1 V, I _{OH} = 4 mA | | 180 | 250 | mV |
| | | T _{min} ≤ T _{amb} ≤ T _{max} | | | 400 | |
| V _{OL} | Low-level output voltage | V _{id} = -1 V, I _{OL} = 4 mA | | 180 | 250 | |
| | | T _{min} ≤ T _{amb} ≤ T _{max} | | | 400 | |
| I _{CC} | Supply current per comparator | No load - outputs low | | 5 | 8 | μA |
| | | T _{min} ≤ T _{amb} ≤ T _{max} | | | 9 | |
| | | No load - outputs high | | 9 | 10 | |
| | | T _{min} ≤ T _{amb} ≤ T _{max} | | | 11 | |
| t _{PLH} | Response time low to high | V _{icm} = 0 V, f = 10 kHz, R _L = 5.1 kΩ, C _L = 50 pF, overdrive = 5 mV | | 2.4 | | μs |
| | | Overdrive = 10 mV | | 1.5 | | |
| | | Overdrive = 20 mV | | 0.9 | | |
| | | Overdrive = 40 mV | | 0.6 | | |
| | | Overdrive = 100 mV | | 0.35 | 0.55 | |
| | | T _{min} ≤ T _{amb} ≤ T _{max} | | | 0.6 | |
| | | TTL input ⁽³⁾ | | 0.45 | 0.6 | |
| | | T _{min} ≤ T _{amb} ≤ T _{max} | | | 0.65 | |
| t _{PHL} | Response time high to low | V _{icm} = 0 V, f = 10 kHz, R _L = 5.1 kΩ, C _L = 50 pF, overdrive = 5 mV | | 2.8 | | μs |
| | | Overdrive = 10 mV | | 1.8 | | |
| | | Overdrive = 20 mV | | 1 | | |
| | | Overdrive = 40 mV | | 0.7 | | |
| | | Overdrive = 100 mV | | 0.46 | 0.6 | |
| | | T _{min} ≤ T _{amb} ≤ T _{max} | | | 0.7 | |
| | | TTL input ⁽³⁾ | | 0.3 | 0.4 | |
| | | T _{min} ≤ T _{amb} ≤ T _{max} | | | 0.5 | |
| t _r | Rise time | f = 10 kHz, C _L = 50 pF, R _L = 5.1 kΩ, overdrive 50 mV | | 30 | | ns |
| t _f | Fall time | f = 10 kHz, C _L = 50 pF, R _L = 5.1 kΩ, overdrive 50 mV | | 30 | | |

Notes:

- ⁽¹⁾The specified offset voltage is the maximum value required to drive the output up to 2.5 V or down to 0.3 V.
- ⁽²⁾Guaranteed by design.
- ⁽³⁾A step from 0 V to 3 V is applied on one input while the other is fixed at 1.4 V. The response time is the time interval between the application of the input voltage step and the moment the output voltage reaches 50 % of its final value.

Table 5: $V_{CC+} = 16\text{ V}$, $V_{CC-} = 0\text{ V}$, $T_{amb} = 25\text{ °C}$ (unless otherwise specified)

| Symbol | Parameter | Condition | Min. | Typ. | Max. | Unit |
|-----------|-------------------------------------|--|------|------|------|---------------|
| V_{io} | Input offset voltage ⁽¹⁾ | $V_{icm} = V_{CC}/2$ | -5 | 0.1 | 5 | mV |
| | | $T_{min} \leq T_{amb} \leq T_{max}$ | -6 | | 6 | |
| I_{io} | Input offset current ⁽²⁾ | $V_{icm} = V_{CC}/2$ | | 1 | 10 | pA |
| | | $T_{min} \leq T_{amb} \leq T_{max}$ | | | 600 | |
| I_{ib} | Input bias current ⁽²⁾ | $V_{icm} = V_{CC}/2$ | | 1 | 10 | pA |
| | | $T_{min} \leq T_{amb} \leq T_{max}$ | | | 1200 | |
| CMR | Common-mode rejection ratio | $V_{icm} = 0$ to $\max V_{icm}$ | 72 | 90 | | dB |
| | | $T_{min} \leq T_{amb} \leq T_{max}$ | 70 | | | |
| SVR | Supply voltage rejection ratio | $V_{CC}^+ = 5\text{ V}$ to 16 V , $V_{icm} = V_{CC}/2$ | 73 | 90 | | dB |
| | | $T_{min} \leq T_{amb} \leq T_{max}$ | 72 | | | |
| V_{OH} | High level output voltage drop | $V_{id} = 1\text{ V}$, $I_{OH} = 4\text{ mA}$ | | 90 | 150 | mV |
| | | $T_{min} \leq T_{amb} \leq T_{max}$ | | | 250 | |
| V_{OL} | Low level output voltage | $V_{id} = -1\text{ V}$, $I_{OL} = 4\text{ mA}$ | | 90 | 150 | mV |
| | | $T_{min} \leq T_{amb} \leq T_{max}$ | | | 250 | |
| I_{CC} | Supply current per comparator | No load - outputs low | | 7 | 9 | μA |
| | | $T_{min} \leq T_{amb} \leq T_{max}$ | | | 10 | |
| | | No load - outputs high | | 11 | 13 | |
| | | $T_{min} \leq T_{amb} \leq T_{max}$ | | | 14 | |
| t_{PLH} | Response time low to high | $V_{icm} = 0\text{ V}$, $f = 10\text{ kHz}$, $R_L = 5.1\text{ k}\Omega$, $C_L = 50\text{ pF}$, overdrive = 5 mV | | 2.2 | | μs |
| | | Overdrive = 10 mV | | 1.4 | | |
| | | Overdrive = 20 mV | | 0.9 | | |
| | | Overdrive = 40 mV | | 0.6 | | |
| | | Overdrive = 100 mV | | 0.34 | 0.55 | |
| | | $T_{min} \leq T_{amb} \leq T_{max}$ | | | | |
| t_{PHL} | Response time high to low | $V_{icm} = 0\text{ V}$, $f = 10\text{ kHz}$, $R_L = 5.1\text{ k}\Omega$, $C_L = 50\text{ pF}$, overdrive = 5 mV | | 2.4 | | μs |
| | | Overdrive = 10 mV | | 1.6 | | |
| | | Overdrive = 20 mV | | 1 | | |
| | | Overdrive = 40 mV | | 0.7 | | |
| | | Overdrive = 100 mV | | 0.55 | 0.7 | |
| | | $T_{min} \leq T_{amb} \leq T_{max}$ | | | | |
| t_r | Rise time | $f = 10\text{ kHz}$, $C_L = 50\text{ pF}$, $R_L = 5.1\text{ k}\Omega$, overdrive 50 mV | | 11 | | ns |
| t_f | Fall time | $f = 10\text{ kHz}$, $C_L = 50\text{ pF}$, $R_L = 5.1\text{ k}\Omega$, overdrive 50 mV | | 11 | | |

Notes:

⁽¹⁾The specified offset voltage is the maximum value required to drive the output up to 2.5 V or down to 0.3 V .

⁽²⁾Guaranteed by design.

5 Electrical characteristic curves

Figure 3: Current consumption vs. supply voltage, output high

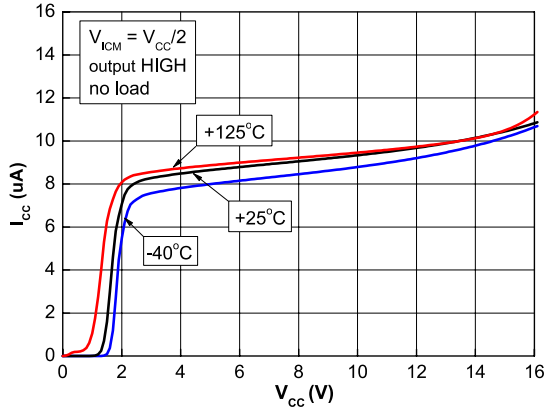

Figure 4: Current consumption vs. supply voltage, output low

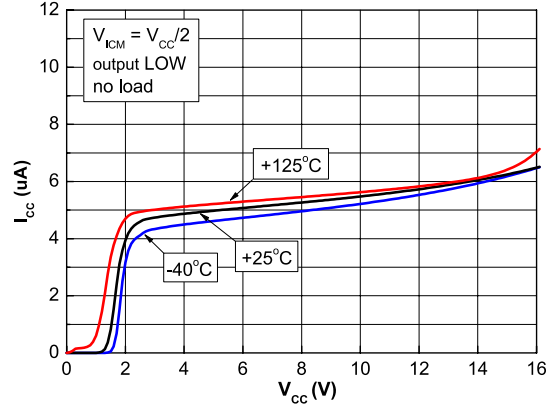

Figure 5: Current consumption vs. input common-mode voltage, output high

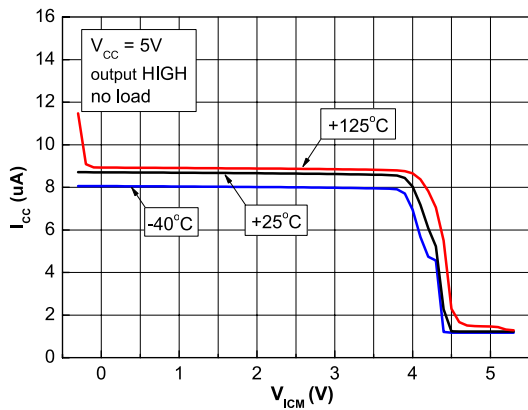

Figure 6: Current consumption vs. common-mode voltage, output low

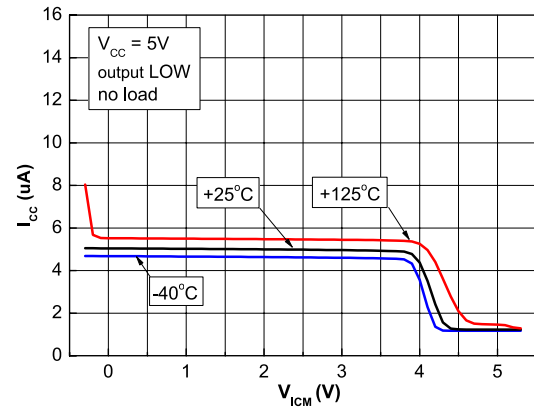

Figure 7: Output voltage drop vs. output source current, VCC = 5 V

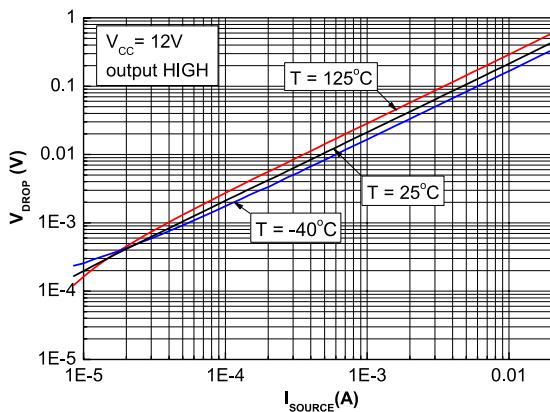

Figure 8: Output voltage drop vs. output source current, VCC = 12 V

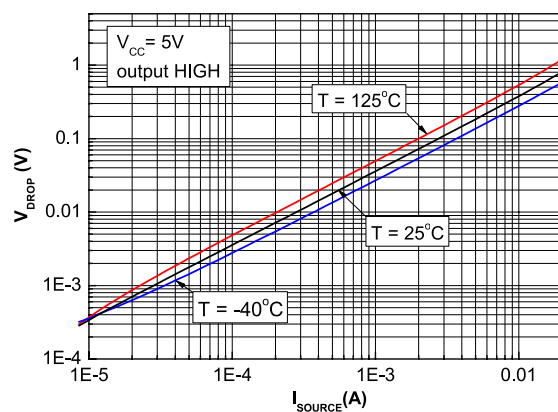

Figure 9: Output voltage drop vs. output sink current, VCC = 5 V

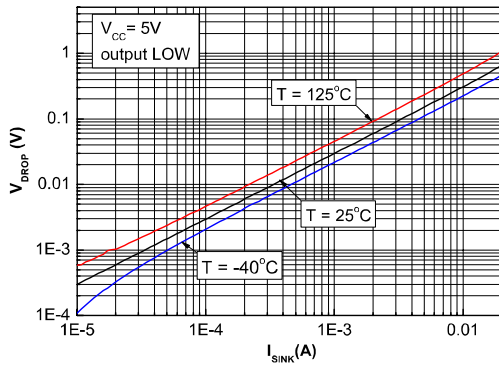

Figure 10: Output voltage drop vs. output sink current, VCC = 12 V

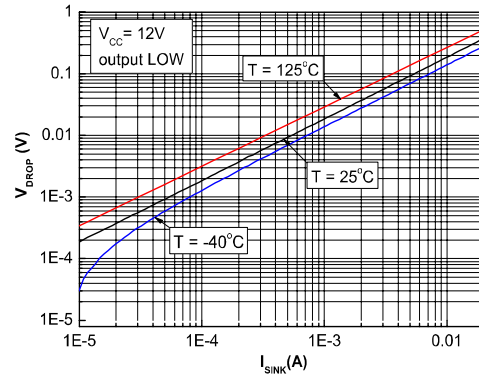

Figure 11: Input offset voltage distribution, VCC = 5 V

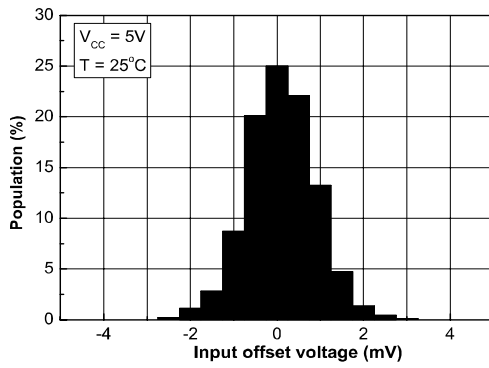

Figure 12: Input current vs input voltage, VCC = 5 V

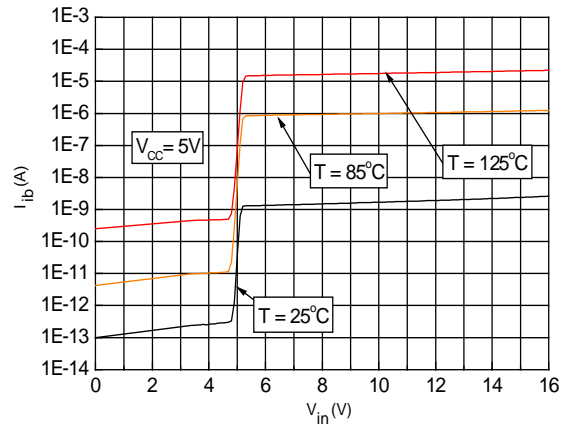

Figure 13: Propagation delay tPLH vs. input signal overdrive, VCC = 5 V

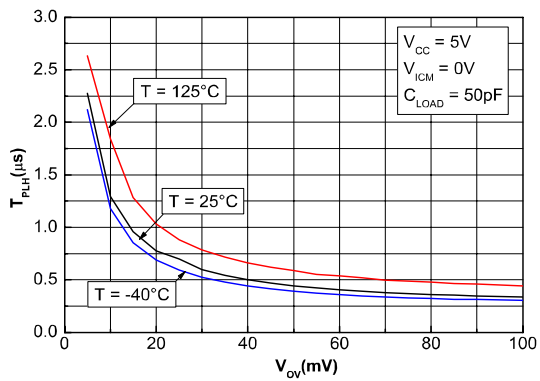

Figure 14: Propagation delay tPHL vs. input signal overdrive, VCC = 5 V

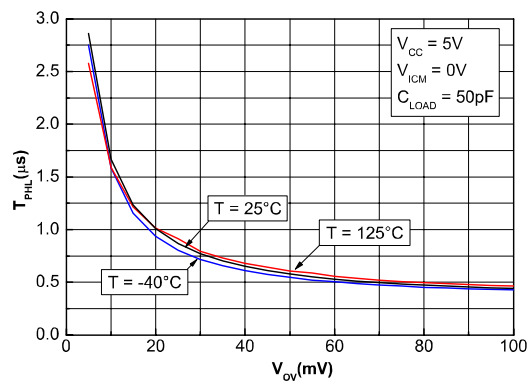

Figure 15: Propagation delay tPLH vs. supply voltage

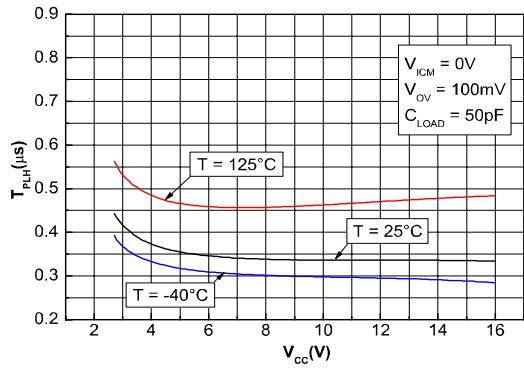
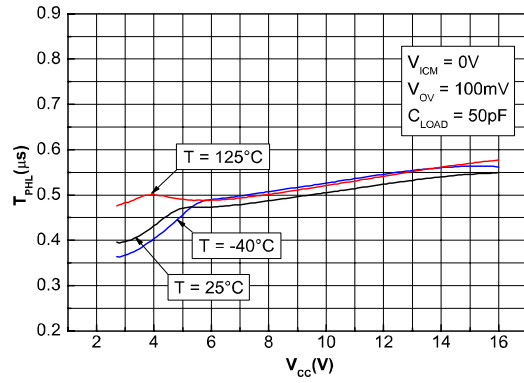

Figure 16: Propagation delay tPHL vs. supply voltage



6 Application information

6.1 Input voltages

The output state is guaranteed as long as one input remains within the common mode input voltage range (defined in the operating conditions table), and the other input remains between -0.3 V and 16 V (meaning that one input can be driven above VCC+).

If one input voltage is beyond the range 0 V to 16 V, this input of the comparator should be protected according to [Figure 17](#).

If the input is lower than Vcc-, a significant current may go through the ESD diode. To protect the circuit, this current must be limited to 10 mA by using the Rg+ or Rg- resistors.

If the input is bigger than 16 V, it has to be voltage limited. This is achieved using the D- or D+ additional, external diodes. To protect these diodes, the current is limited using the Rg resistor. D- and D+ diodes can be connected to another power supply with a maximum value of 16 V. The device is designed to prevent phase reversal.

Figure 17: Additional, external, protection schematic



6.2 For unused channel

An unused comparator has to be configured to avoid unexpected additional consumption. A simple solution is to connect the input to the power supply pins as shown in [Figure 18](#). This keeps the circuit in a stable state.

Figure 18: Input configuration for unused channel

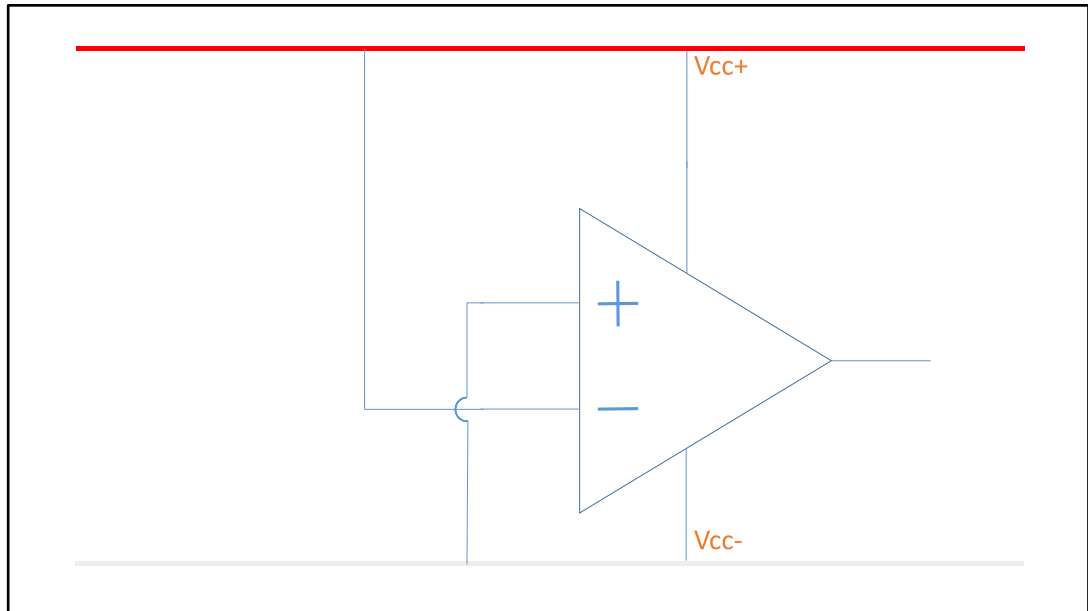

6.3 Bypass capacitor

To maintain proper coupling of the power supply, it is strongly recommended to place a 0.1 μF capacitor as close as possible to the supply pins.

7 Package information

In order to meet environmental requirements, ST offers these devices in different grades of ECOPACK[®] packages, depending on their level of environmental compliance. ECOPACK[®] specifications, grade definitions and product status are available at: www.st.com. ECOPACK[®] is an ST trademark.

7.1 SO14 package information

Figure 19: SO14 package outline

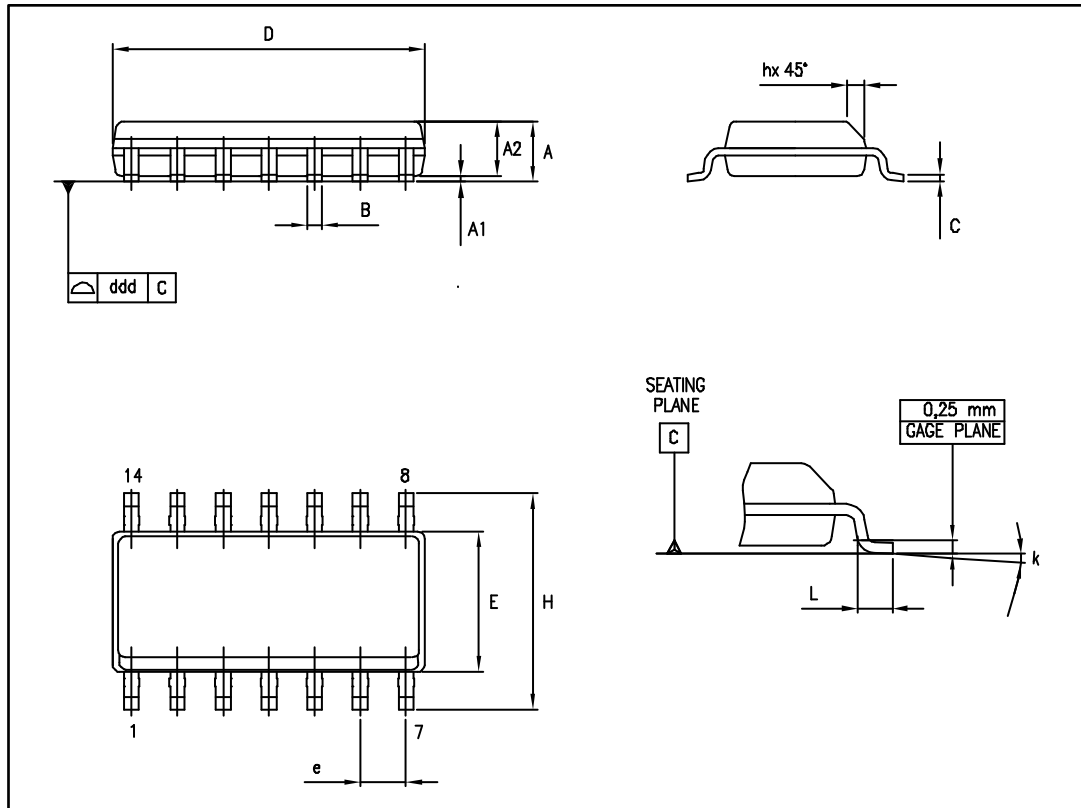

Table 6: SO14 mechanical data

| Ref. | Dimensions | | | | | |
|------|-------------|------|------|--------|------|-------|
| | Millimeters | | | Inches | | |
| | Min. | Typ. | Max. | Min. | Typ. | Max. |
| A | 1.35 | | 1.75 | 0.05 | | 0.068 |
| A1 | 0.10 | | 0.25 | 0.004 | | 0.009 |
| A2 | 1.10 | | 1.65 | 0.04 | | 0.06 |
| B | 0.33 | | 0.51 | 0.01 | | 0.02 |
| C | 0.19 | | 0.25 | 0.007 | | 0.009 |
| D | 8.55 | | 8.75 | 0.33 | | 0.34 |
| E | 3.80 | | 4.0 | 0.15 | | 0.15 |
| e | | 1.27 | | | 0.05 | |
| H | 5.80 | | 6.20 | 0.22 | | 0.24 |
| h | 0.25 | | 0.50 | 0.009 | | 0.02 |
| L | 0.40 | | 1.27 | 0.015 | | 0.05 |
| k | 8° (max) | | | | | |
| ddd | | | 0.10 | | | 0.004 |

7.2 TSSOP14 package information

Figure 20: TSSOP14 package outline

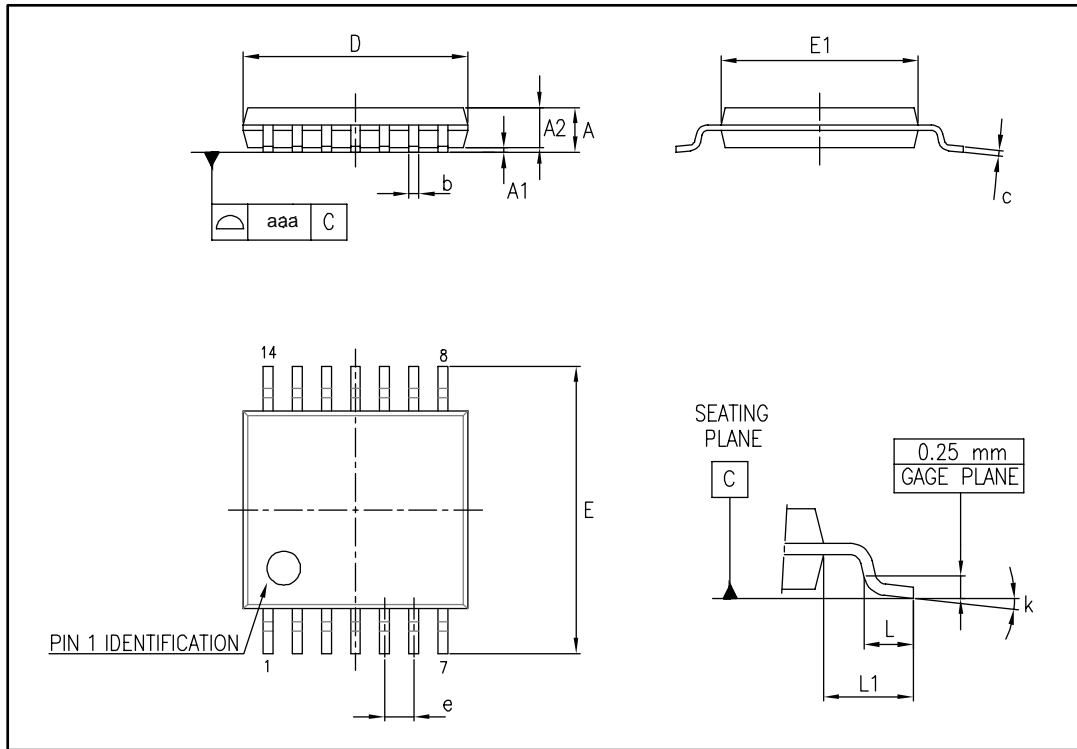

Table 7: TSSOP14 mechanical data

| Ref. | Dimensions | | | | | |
|------|-------------|------|------|--------|--------|--------|
| | Millimeters | | | Inches | | |
| | Min. | Typ. | Max. | Min. | Typ. | Max. |
| A | | | 1.20 | | | 0.047 |
| A1 | 0.05 | | 0.15 | 0.002 | 0.004 | 0.006 |
| A2 | 0.80 | 1.00 | 1.05 | 0.031 | 0.039 | 0.041 |
| b | 0.19 | | 0.30 | 0.007 | | 0.012 |
| c | 0.09 | | 0.20 | 0.004 | | 0.0089 |
| D | 4.90 | 5.00 | 5.10 | 0.193 | 0.197 | 0.201 |
| E | 6.20 | 6.40 | 6.60 | 0.244 | 0.252 | 0.260 |
| E1 | 4.30 | 4.40 | 4.50 | 0.169 | 0.173 | 0.176 |
| e | | 0.65 | | | 0.0256 | |
| L | 0.45 | 0.60 | 0.75 | 0.018 | 0.024 | 0.030 |
| L1 | | 1.00 | | | 0.039 | |
| k | 0° | | 8° | 0° | | 8° |
| aaa | | | 0.10 | | | 0.004 |

7.3 QFN16 3x3 package information

Figure 21: QFN16 3x3 package outline



The exposed pad is not internally connected and can be set to ground or left floating.

Table 8: QFN16 3x3 mechanical data

| Ref. | Dimensiones | | | | | |
|------|-------------|------|------|--------|-------|-------|
| | Millimeters | | | Inches | | |
| | Min. | Typ. | Max. | Min. | Typ. | Max. |
| A | 0.80 | 0.90 | 1.00 | 0.031 | 0.035 | 0.039 |
| A1 | 0 | | 0.05 | 0 | | 0.002 |
| A3 | | 0.20 | | | 0.008 | |
| b | 0.18 | | 0.30 | 0.007 | | 0.012 |
| D | 2.90 | 3.00 | 3.10 | 0.114 | 0.118 | 0.122 |
| D2 | 1.50 | | 1.80 | 0.059 | | 0.071 |
| E | 2.90 | 3.00 | 3.10 | 0.114 | 0.118 | 0.122 |
| E2 | 1.50 | | 1.80 | 0.059 | | 0.071 |
| e | | 0.50 | | | 0.020 | |
| L | 0.30 | | 0.50 | 0.012 | | 0.020 |

Figure 22: QFN16 3x3 recommended footprint

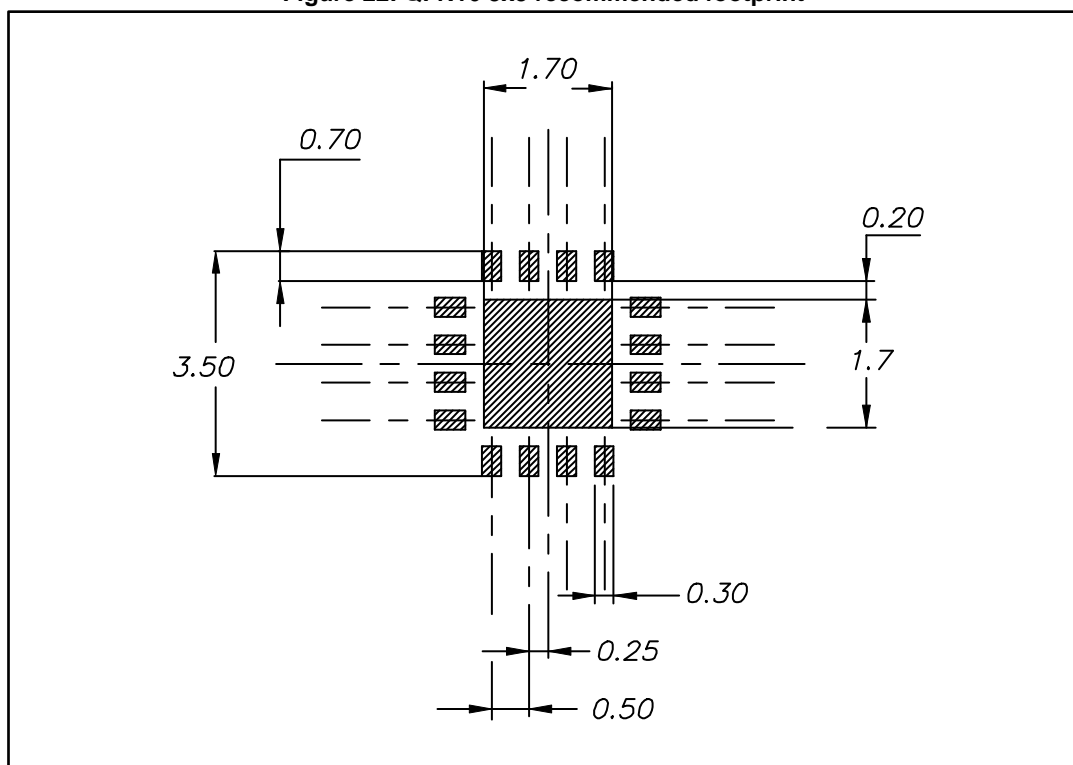

8 Ordering information

Table 9: Order codes

| Order code | Temperature range | Package | Packing | Marking |
|----------------------------|-------------------|-------------------------------|---------------|-----------|
| TSX3704IDT | -40 °C to 125 °C | SO14 | Tape and reel | TSX3704ID |
| TSX3704IPT | | TSSOP14 | | TSX3704I |
| TSX3704IQ4T | | QFN16 3x3 | | K533 |
| TSX3704IYPT ⁽¹⁾ | | TSSOP14 (automotive grade) | | TSX3704IY |

Notes:

⁽¹⁾Qualification and characterization according to AEC Q100 and Q003 or equivalent, advanced screening according to AEC Q001 & Q 002 or equivalent are on-going.

9 Revision history

Table 10: Document revision history

| Date | Revision | Changes |
|-------------|----------|--|
| 16-Dec-2015 | 1 | Initial release |
| 29-Feb-2016 | 2 | Table 3 , Table 4 , and Table 5 : updated V_{OH} and V_{OL} condition $I_{OH}/I_{OL} = 4$ mA (not 6mA). |

IMPORTANT NOTICE – PLEASE READ CAREFULLY

STMicroelectronics NV and its subsidiaries ("ST") reserve the right to make changes, corrections, enhancements, modifications, and improvements to ST products and/or to this document at any time without notice. Purchasers should obtain the latest relevant information on ST products before placing orders. ST products are sold pursuant to ST's terms and conditions of sale in place at the time of order acknowledgement.

Purchasers are solely responsible for the choice, selection, and use of ST products and ST assumes no liability for application assistance or the design of Purchasers' products.

No license, express or implied, to any intellectual property right is granted by ST herein.

Resale of ST products with provisions different from the information set forth herein shall void any warranty granted by ST for such product.

ST and the ST logo are trademarks of ST. All other product or service names are the property of their respective owners.

Information in this document supersedes and replaces information previously supplied in any prior versions of this document.

© 2016 STMicroelectronics – All rights reserved

Компания «Life Electronics» занимается поставками электронных компонентов импортного и отечественного производства от производителей и со складов крупных дистрибьюторов Европы, Америки и Азии.

С конца 2013 года компания активно расширяет линейку поставок компонентов по направлению коаксиальный кабель, кварцевые генераторы и конденсаторы (керамические, пленочные, электролитические), за счёт заключения дистрибьюторских договоров

Мы предлагаем:

- Конкурентоспособные цены и скидки постоянным клиентам.
- Специальные условия для постоянных клиентов.
- Подбор аналогов.
- Поставку компонентов в любых объемах, удовлетворяющих вашим потребностям.
- Приемлемые сроки поставки, возможна ускоренная поставка.
- Доставку товара в любую точку России и стран СНГ.
- Комплексную поставку.
- Работу по проектам и поставку образцов.
- Формирование склада под заказчика.
- Сертификаты соответствия на поставляемую продукцию (по желанию клиента).
- Тестирование поставляемой продукции.
- Поставку компонентов, требующих военную и космическую приемку.
- Входной контроль качества.
- Наличие сертификата ISO.

В составе нашей компании организован Конструкторский отдел, призванный помогать разработчикам, и инженерам.

Конструкторский отдел помогает осуществить:

- Регистрацию проекта у производителя компонентов.
- Техническую поддержку проекта.
- Защиту от снятия компонента с производства.
- Оценку стоимости проекта по компонентам.
- Изготовление тестовой платы монтаж и пусконаладочные работы.



Тел: +7 (812) 336 43 04 (многоканальный)

Email: org@lifeelectronics.ru