

FEATURES

- Passive, wideband I/Q mixer
- RF and local oscillator (LO) range: 6 GHz to 26.5 GHz
- Wide IF of dc to 5 GHz
- Single-ended RF, LO, and IF
- Conversion loss: -10 dB
- Input IP3: 24 dBm (typical)
- Image rejection: 25 dBm (typical)
- High LO to RF isolation: 35 dB
- High LO to IF isolation: 37 dB
- Phase balance: $\pm 5^\circ$
- Exposed paddle, 4 mm \times 4 mm, 24-lead LFCSP package

APPLICATIONS

- Test and measurement instrumentation
- Military, aerospace, and defense applications
- Microwave point-to-point base stations

FUNCTIONAL BLOCK DIAGRAM

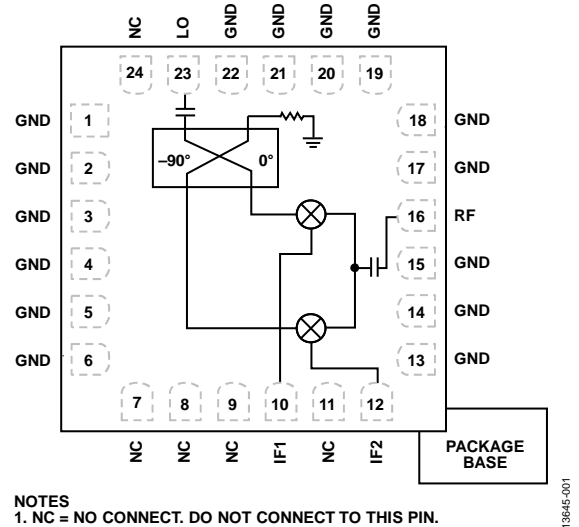

Figure 1.

GENERAL DESCRIPTION

HMC8191 is a passive wideband I/Q MMIC mixer that can be used either as an image reject mixer for receiver operations or as a single sideband upconverter for transmitter operations. With an RF and LO range of 6 GHz to 26.5 GHz, and an IF bandwidth of dc to 5 GHz, the **HMC8191** is ideal for applications requiring wide frequency range, excellent RF performance, and a simpler design with fewer parts and a smaller printed circuit board (PCB) footprint. A single **HMC8191** can replace multiple narrowband mixers in a design. The inherent I/Q architecture of the **HMC8191** offers excellent image rejection and thereby eliminates the need for expensive filtering for unwanted sidebands. The mixer also provides

excellent LO to RF and LO to IF isolation and reduces the effect of LO leakage to ensure signal integrity

Being a passive mixer, the **HMC8191** does not require any dc power sources. It offers a lower noise figure compared to an active mixer, ensuring superior dynamic range for high performance and precision applications.

The **HMC8191** is fabricated on a GaAs MESFET process and uses Analog Devices, Inc., mixer cells and a 90-degree hybrid. It is available in a compact 4 mm \times 4 mm, 24-lead LFCSP package and operates over a -40°C to +85°C temperature range. An evaluation board for this device is also available.

TABLE OF CONTENTS

Features	1	Pin Configuration and Function Descriptions.....	5
Applications.....	1	Typical Performance Characteristics	6
Functional Block Diagram	1	f_{RFIN} at 100 MHz	6
General Description	1	f_{RFIN} at 2.5 GHz	7
Specifications.....	3	f_{RFIN} at 5 GHz	8
Absolute Maximum Ratings.....	4	Evaluation Board	9
ESD Caution.....	4	Outline Dimensions	11

SPECIFICATIONS

$f_{IF\ OUT} = f_{RF\ IN} - f_{LO}$ (downconverter, upper sideband), $f_{RF\ IN} = 0.1\ \text{GHz to } 5\ \text{GHz}$, $P_{RF\ IN} = -10\ \text{dBm}$, $P_{LO} = 18\ \text{dBm}$, $T_A = 25^\circ\text{C}$.

Table 1.

Parameter	Test Conditions	Min	Typ	Max	Unit
RF INPUT INTERFACE					
Return Loss		7	10		dB
Input Impedance			50		Ω
RF Input Frequency Range		6000		26,500	MHz
IF INTERFACE					
Return Loss		7	10		dB
IF Impedance			50		Ω
IF Frequency Range		DC		5000	MHz
LO INTERFACE					
LO Power			18		dBm
Return Loss		9	10		dB
Input Impedance			50		Ω
LO Frequency Range		6000		26,500	MHz
DOWNCONVERTER DYNAMIC PERFORMANCE at $f_{IF\ OUT} = 100\ \text{MHz}$					
Conversion Loss			10		dB
Input Third-Order Intercept		19	25		dBm
Image Rejection		18	26		dB
LO to RF Isolation ¹			35		dB
LO to IF Isolation ¹			35		dB
RF to IF Isolation ¹			18		dB
Phase Balance			TBD		Degrees
Amplitude Balance			TBD		dB
DOWNCONVERTER DYNAMIC PERFORMANCE at $f_{IF\ OUT} = 2.5\ \text{GHz}$					
Conversion Loss			10		dB
Input Third-Order Intercept		20	24		dBm
Image Rejection		25	30		dB
LO to RF Isolation ¹			35		dB
LO to IF Isolation ¹			35		dB
RF to IF Isolation ¹			18		dB
Phase Balance		-10			Degrees
Amplitude Balance		-0.5	0	+0.6	dB
DOWNCONVERTER DYNAMIC PERFORMANCE at $f_{IF\ OUT} = 5\ \text{GHz}$					
Conversion Loss			11		dB
Input Third-Order Intercept		20	25		dBm
Image Rejection		18	24		dB
LO to RF Isolation ¹			35		dB
LO to IF Isolation ¹			35		dB
RF to IF Isolation ¹			18		dB
Balance			TBD		Degrees
Amplitude Balance			TBD		dB

¹ See the Typical Performance Characteristics section.

ABSOLUTE MAXIMUM RATINGS

Table 2.

Parameter	Rating
RFIN Power	TBD
LO Drive	TBD
Channel Temperature	TBD
Continuous P_{DISS} ($T = 85^{\circ}\text{C}$) (Derate 9.8 mW/ $^{\circ}\text{C}$ above 85 $^{\circ}\text{C}$)	TBD
Thermal Resistance ($R_{\theta JH}$) (Junction to Die Bottom)	TBD
Operating Temperature Range	-40 $^{\circ}\text{C}$ to +85 $^{\circ}\text{C}$
Storage Temperature Range	-65 $^{\circ}\text{C}$ to +150 $^{\circ}\text{C}$
ESD Sensitivity (HBM)	TBD

Stresses above those listed under Absolute Maximum Ratings may cause permanent damage to the device. This is a stress rating only; functional operation of the device at these or any other conditions above those indicated in the operational section of this specification is not implied. Exposure to absolute maximum rating conditions for extended periods may affect device reliability.

ESD CAUTION



ESD (electrostatic discharge) sensitive device. Charged devices and circuit boards can discharge without detection. Although this product features patented or proprietary protection circuitry, damage may occur on devices subjected to high energy ESD. Therefore, proper ESD precautions should be taken to avoid performance degradation or loss of functionality.

PIN CONFIGURATION AND FUNCTION DESCRIPTIONS

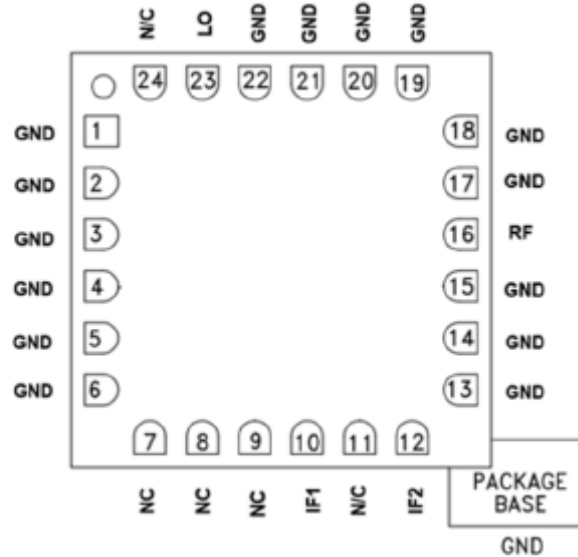

Figure 2. Pin Configuration

Table 3. Pin Function Descriptions

Pin No.	Mnemonic	Description
7 to 9, 11, 24	NC	No Connect. These pins may be connected to RF/dc ground without affecting performance.
1 to 6, 13, 14, 17 to 22 10, 12	GND IF1, IF2	Ground. These pins and package bottom must be connected to RF/dc ground. These pins are dc-coupled. For applications not requiring operations to dc, this port should be dc blocked externally using a series capacitor whose value is selected to pass the necessary IF frequency range. For operations to dc, this pin must not source/sink more than 3 mA of current, otherwise, the device does not function and may fail.
16	RF	This pin is dc-coupled and matched to 50 Ω.
23	LO	This pin is dc-coupled and matched to 50 Ω.

TYPICAL PERFORMANCE CHARACTERISTICS

f_{RFIN} at 100 MHz

$f_{IFOUT} = f_{LO} - f_{RFIN}$ (downconverter, lower sideband), $f_{RFIN} = 100$ MHz, $P_{RFIN} = -10$ dBm, $P_{LO} = 18$ dBm, $T_A = 25^\circ\text{C}$.

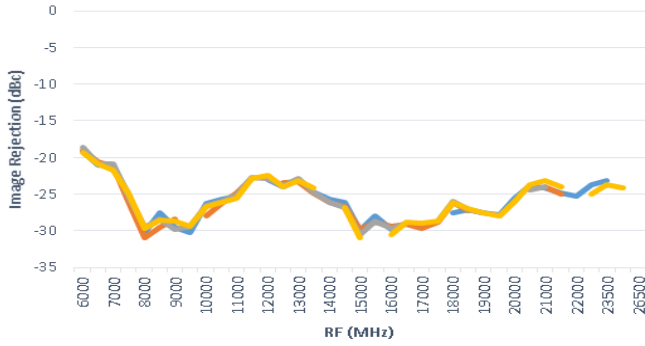

Figure 3. Image Rejection, Downconverter

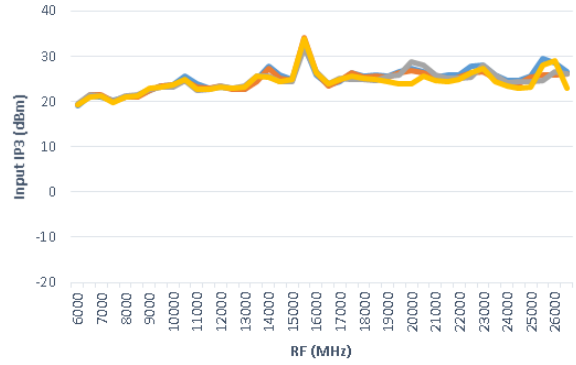

Figure 5. Input IP3, Downconverter

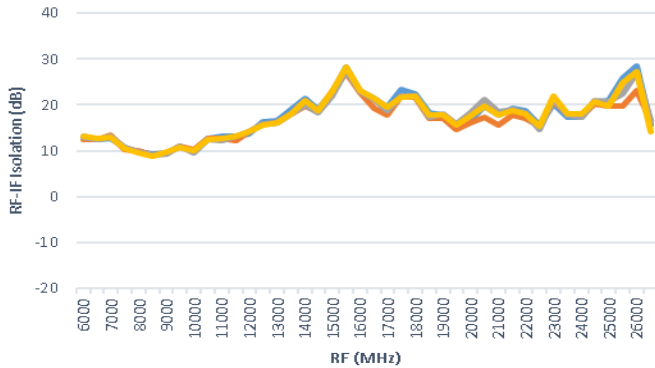

Figure 4. RF to IF Isolation, Downconverter

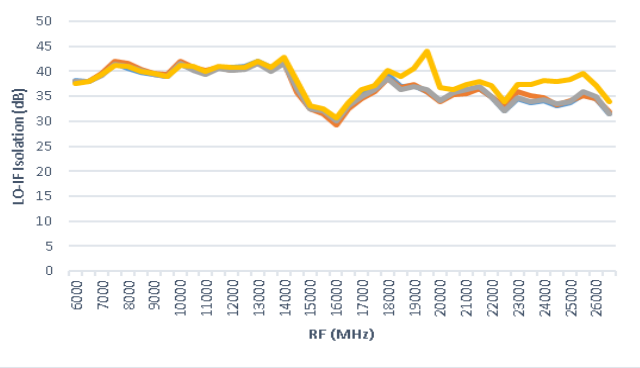

Figure 6. LO to IF Isolation, Downconverter

f_{RFIN} at 2.5 GHz

f_{IFOUT} = f_{LO} - f_{RFIN} (downconverter, lower sideband), f_{RFIN} = 2.5 GHz, P_{RFIN} = -10dBm, P_{LO} = 14 dBm, 16 dBm, 18 dBm, 20 dBm, T_A = 25°C.

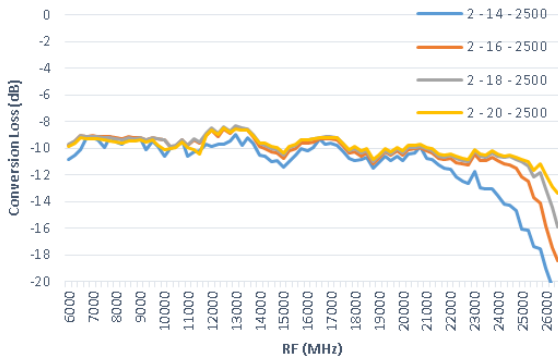

Figure 7. Conversion Loss, Downconverter

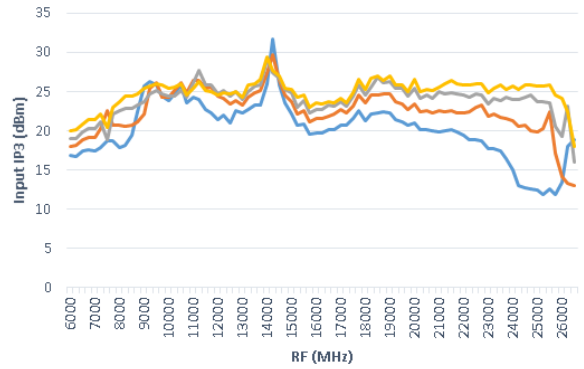

Figure 10. Input IP3, Downconverter

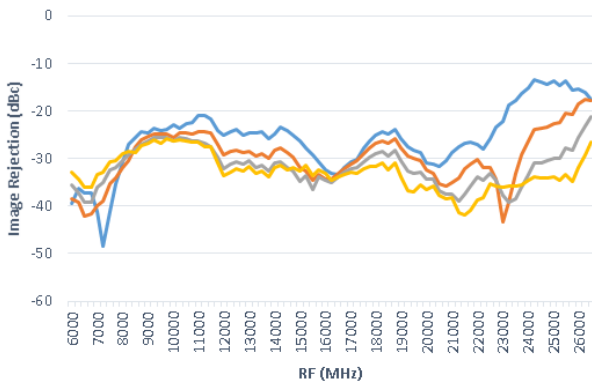

Figure 8. Image Rejection, Downconverter

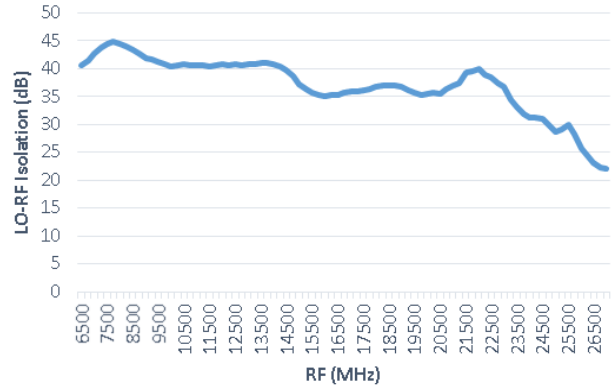

Figure 11. LO to RF Isolation, Downconverter

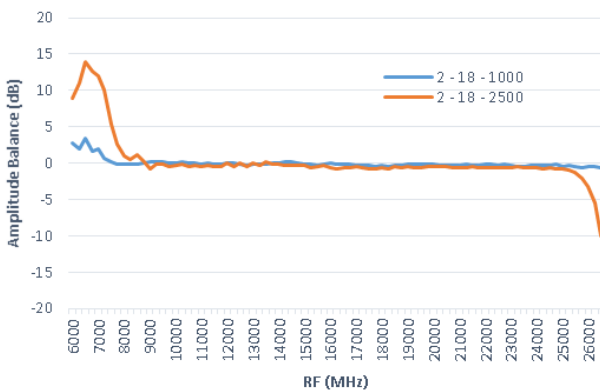

Figure 9. Amplitude Balance, Downconverter

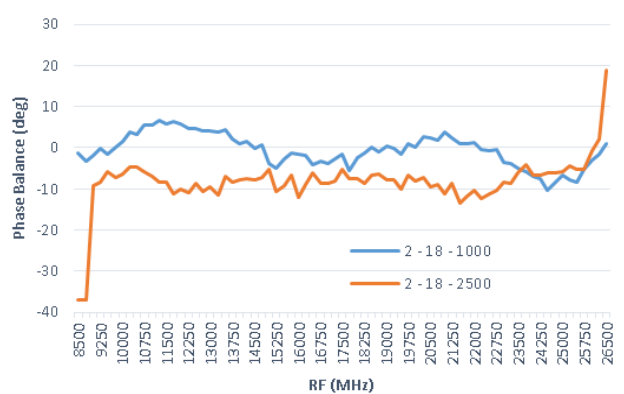

Figure 12. Phase Balance, Downconverter

f_{RFIN} at 5 GHz

$f_{IFOUT} = f_{LO} - f_{RFIN}$ (downconverter, lower sideband), $f_{RFIN} = 5$ GHz, $P_{RFIN} = -10$ dBm, $P_{LO} = 14$ dBm, 16 dBm, 18 dBm, 20 dBm, $T_A = 25^\circ\text{C}$.

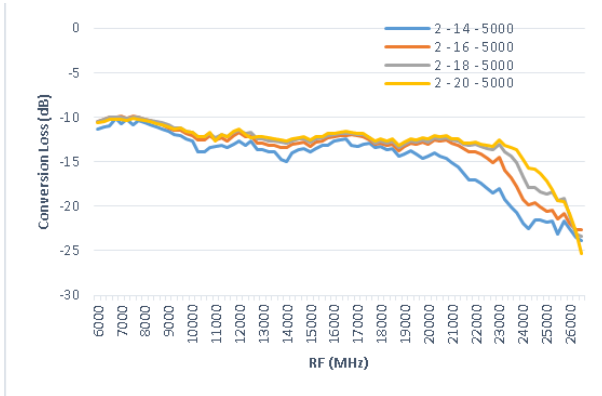

Figure 13. Conversion Loss, Downconverter

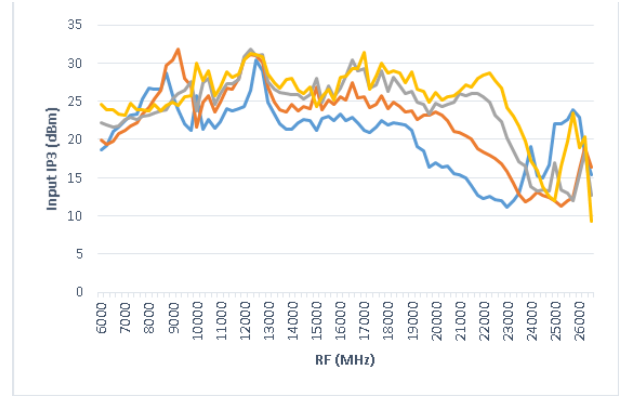

Figure 15. Input IP3, Downconverter

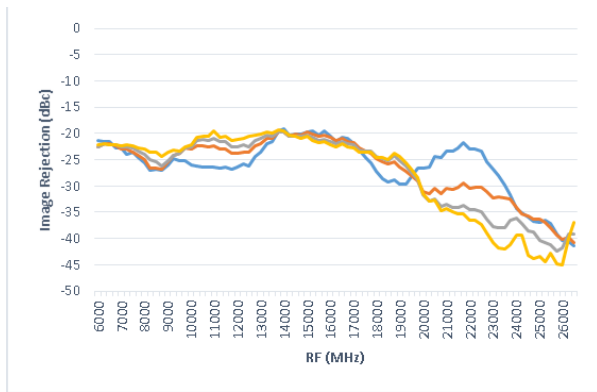

Figure 14. Image Rejection, Downconverter

EVALUATION BOARD

An evaluation board is available for the [HMC8191](#). The standard evaluation board is fabricated using Rogers® RO4003C material. The schematic for the evaluation board is shown in Figure 16.

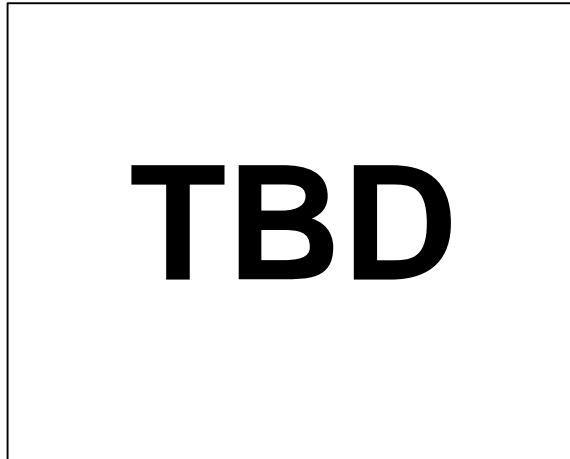

Figure 16. Evaluation Board Schematic

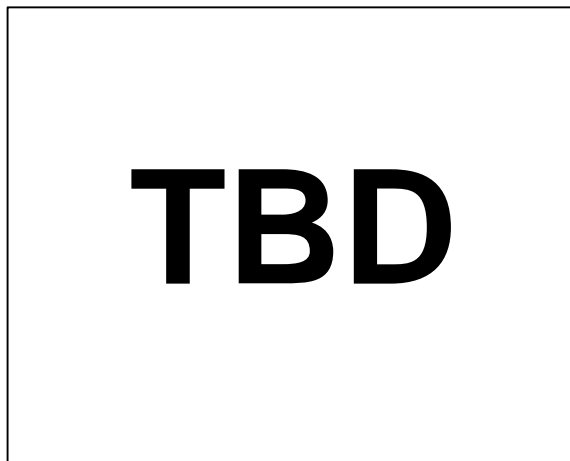

Figure 17. Evaluation Board, Top Layer

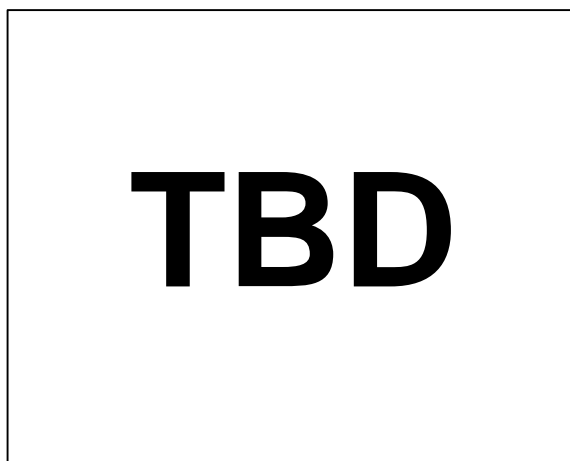

Figure 18. Evaluation Board, Bottom Layer

Table 4 describes the various configuration options for the evaluation board. Layouts for the board are shown in Figure 17 and Figure 18.

Table 4. Evaluation Board Configuration

Components	Function	Default Conditions
TBD		

OUTLINE DIMENSIONS

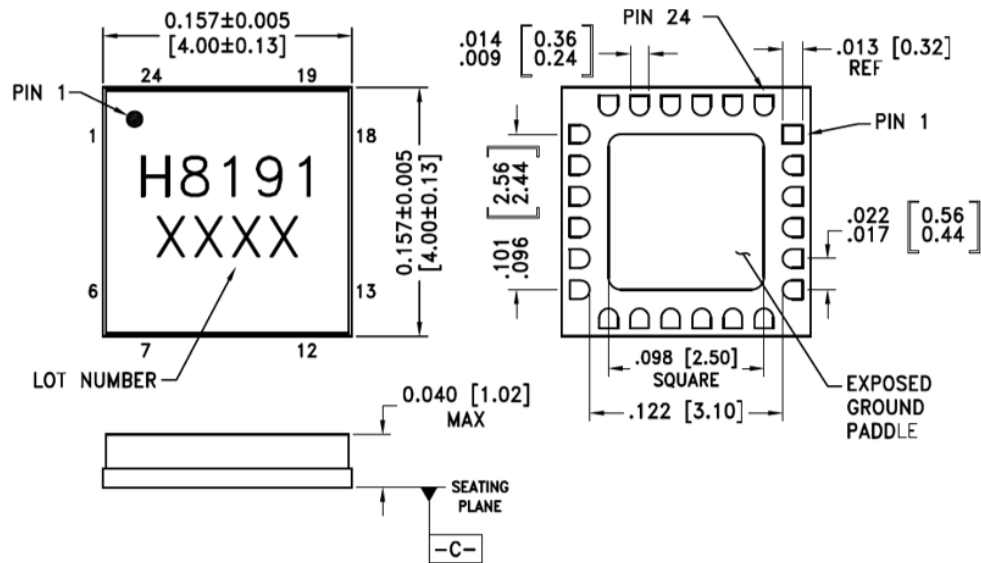

Figure 19. HMC8191 Outline Drawing and Dimensions

Компания «Life Electronics» занимается поставками электронных компонентов импортного и отечественного производства от производителей и со складов крупных дистрибьюторов Европы, Америки и Азии.

С конца 2013 года компания активно расширяет линейку поставок компонентов по направлению коаксиальный кабель, кварцевые генераторы и конденсаторы (керамические, пленочные, электролитические), за счёт заключения дистрибьюторских договоров

Мы предлагаем:

- Конкурентоспособные цены и скидки постоянным клиентам.
- Специальные условия для постоянных клиентов.
- Подбор аналогов.
- Поставку компонентов в любых объемах, удовлетворяющих вашим потребностям.
- Приемлемые сроки поставки, возможна ускоренная поставка.
- Доставку товара в любую точку России и стран СНГ.
- Комплексную поставку.
- Работу по проектам и поставку образцов.
- Формирование склада под заказчика.
- Сертификаты соответствия на поставляемую продукцию (по желанию клиента).
- Тестирование поставляемой продукции.
- Поставку компонентов, требующих военную и космическую приемку.
- Входной контроль качества.
- Наличие сертификата ISO.

В составе нашей компании организован Конструкторский отдел, призванный помогать разработчикам, и инженерам.

Конструкторский отдел помогает осуществить:

- Регистрацию проекта у производителя компонентов.
- Техническую поддержку проекта.
- Защиту от снятия компонента с производства.
- Оценку стоимости проекта по компонентам.
- Изготовление тестовой платы монтаж и пусконаладочные работы.



Тел: +7 (812) 336 43 04 (многоканальный)

Email: org@lifeelectronics.ru