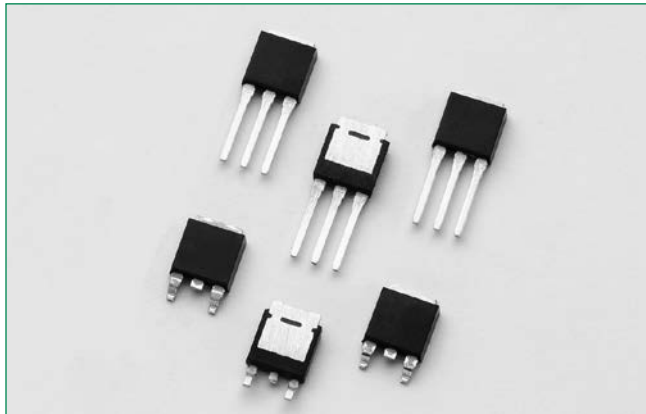


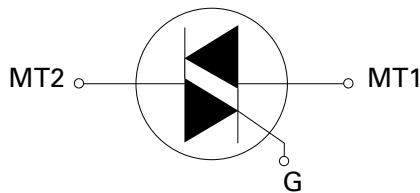
### LJxx06xx & QJxx06xHx series



#### Main Features

Symbol	Value	Unit
$I_{T(RMS)}$	6	A
$V_{DRM}/V_{RRM}$	400 or 600	V
$I_{GT(Q1)}$	10 to 35	mA

#### Schematic Symbol



#### Description

This 6 A High Temperature Alternistor Triac solid state switch series is designed for AC switching and phase control applications such as motor speed and temperature modulation controls, lighting controls, and static switching relays.

**Sensitive** type components guarantee gate control in Quadrants I & IV as needed for digital control circuitry.

**Alternistor** type components only operate in quadrants I, II, & III and are used in circuits requiring high dv/dt capability.

#### Features & Benefits

- 150°C maximum junction temperature
- Voltage capability up to 600V
- Surge capability up to 72A at 60Hz half cycle
- Solid-state switching eliminates arcing or contact bounce that create voltage transients
- No contacts to wear out from reaction of switching events
- Restricted (or limited) RFI generation, depending on activation point of sine wave
- Requires only a short gate activation pulse in each half-cycle
- Halogen free and RoHS compliant

#### Applications

Excellent for AC switching and phase control applications such as heating, lighting, and motor speed controls.

Typical applications are AC solid-state switches, light dimmers, power tools, home/brown goods and white goods appliances.

Alternistor Triacs (no snubber required) are used in applications with high inductive loads requiring the highest commutation performance.

Internally constructed isolated packages are offered for ease of heat sinking with highest isolation voltage.

#### Absolute Maximum Ratings — Sensitive Triac (4 Quadrants)

Symbol	Parameter	Value	Unit
$V_{DSM}/V_{RSM}$	Peak non-repetitive blocking voltage	PW=100 $\mu$ s	700 V
$I_{T(RMS)}$	RMS on-state current (full sine wave)	LJxx06Vy/LJxx06Dy	$T_c = 125^\circ\text{C}$ 6 A
$I_{TSM}$	Non repetitive surge peak on-state current (full cycle, $T_j$ initial = 25°C)	f = 50 Hz t = 20 ms	60 A
		f = 60 Hz t = 16.7 ms	72 A
$I^2t$	$I^2t$ Value for fusing	$t_p = 8.3$ ms	21.5 A <sup>2</sup> s
di/dt	Critical rate of rise of on-state current $I_g = 50$ mA with 0.1 $\mu$ s rise time	f = 60 Hz	$T_j = 150^\circ\text{C}$ 70 A/ $\mu$ s
$I_{GTM}$	Peak gate trigger current	$t_p = 20$ $\mu$ s	$T_j = 150^\circ\text{C}$ 4 A
$P_{G(AV)}$	Average gate power dissipation	$T_j = 150^\circ\text{C}$	0.4 W
$T_{stg}$	Storage temperature range		-40 to 150 °C
$T_j$	Operating junction temperature range		-40 to 150 °C

Note: xx=voltage/10,  $\gamma$  = sensitivity

### Absolute Maximum Ratings — Alternistor Triac (3 Quadrants)

Symbol	Parameter		Value	Unit		
$V_{DSM}/N_{RSM}$	Peak non-repetitive blocking voltage		PW=100 $\mu$ s	700	V	
$I_{T(RMS)}$	RMS on-state current (full sine wave)		QJxx06VHy/QJxx06DHy	$T_C = 130^\circ\text{C}$	6	A
$I_{TSM}$	Non repetitive surge peak on-state current (full cycle, $T_J$ initial = $25^\circ\text{C}$ )	f = 50 Hz	t = 20 ms	QJxx06VHy QJxx06DHy	60	A
		f = 60 Hz	t = 16.7 ms	QJxx06VHy QJxx06DHy	72	
$I^2t$	$I^2t$ Value for fusing	$t_p = 8.3$ ms	QJxx06VHy QJxx06DHy	21.5	A <sup>2</sup> s	
di/dt	Critical rate of rise of on-state current	f = 60 Hz	$T_J = 150^\circ\text{C}$	70	A/ $\mu$ s	
$I_{GTM}$	Peak gate trigger current	$t_p = 20$ $\mu$ s	$T_J = 150^\circ\text{C}$	4	A	
$P_{G(AV)}$	Average gate power dissipation		$T_J = 150^\circ\text{C}$	0.3	W	
$T_{stg}$	Storage temperature range			-40 to 150	$^\circ\text{C}$	
$T_J$	Operating junction temperature range			-40 to 150	$^\circ\text{C}$	

Note: xx=voltage/10, y = sensitivity

### Electrical Characteristics ( $T_J = 25^\circ\text{C}$ , unless otherwise specified) — Sensitive Triac (4 Quadrants)

Symbol	Test Conditions	Quadrant		Value	Unit
				LJxx06x8	
$I_{GT}$	$V_D = 12\text{V}$ $R_L = 60\ \Omega$	I – II – III IV	MAX.	10 20	mA
$V_{GT}$		ALL	MAX.	1.2	V
$V_{GD}$	$V_D = V_{DRM}$ $R_L = 3.3\ \text{k}\Omega$ $T_J = 150^\circ\text{C}$	ALL	MIN.	0.15	V
$I_H$	$I_T = 100\text{mA}$		MAX.	25	mA
dv/dt	$V_D = V_{DRM}$ Gate Open $T_J = 150^\circ\text{C}$	400V	TYP.	80	V/ $\mu$ s
		600V		50	
(dv/dt)c	(di/dt)c = 3.2 A/ms $T_J = 150^\circ\text{C}$		TYP.	2	V/ $\mu$ s
$t_{gt}$	$I_G = 2 \times I_{GT}$ PW = 15 $\mu$ s $I_T = 8.5\ \text{A(pk)}$		TYP.	12	$\mu$ s

Note: xx=voltage/10, x = package

### Electrical Characteristics ( $T_J = 25^\circ\text{C}$ , unless otherwise specified) — Alternistor Triac (3 Quadrants)

Symbol	Test Conditions	Quadrant		Value			Unit	
				QJxx06xH2	QJxx06xH3	QJxx06xH4		
$I_{GT}$	$V_D = 12\text{V}$ $R_L = 60\ \Omega$	I – II – III	MAX.	10	20	35	mA	
$V_{GT}$		I – II – III	MAX.	1.3			V	
$V_{GD}$	$V_D = V_{DRM}$ $R_L = 3.3\ \text{k}\Omega$ $T_J = 150^\circ\text{C}$	I – II – III	MIN.	0.15			V	
$I_H$	$I_T = 100\text{mA}$		MAX.	25	30	35	mA	
dv/dt	$V_D = V_{DRM}$ Gate Open $T_J = 150^\circ\text{C}$	QJxx06VHY/ QJxx06DHy	MIN.	400V	150	250	350	V/ $\mu$ s
				600V	100	200	250	
(dv/dt)c	(di/dt)c = 3.2 A/ms $T_J = 150^\circ\text{C}$		MIN.	15	18	20	V/ $\mu$ s	
$t_{gt}$	$I_G = 2 \times I_{GT}$ PW = 15 $\mu$ s $I_T = 8.5\ \text{A(pk)}$		TYP.	10	10	10	$\mu$ s	

Note: xx=voltage/10, x = package

### Static Characteristics

Symbol	Test Conditions		Value	Unit			
$V_{TM}$	$I_{TM} = 8.4 \text{ A}$ $t_p = 380 \mu\text{s}$		MAX.	1.40	V		
$I_{DRM} / I_{RRM}$	$V_{DRM} = V_{RRM}$	LJxx06xy	$T_j = 25^\circ\text{C}$	400 - 600V	MAX.	10	$\mu\text{A}$
			$T_j = 125^\circ\text{C}$	400 - 600V		0.5	mA
			$T_j = 150^\circ\text{C}$	400 - 600V		3	
		QJxx06xHy	$T_j = 25^\circ\text{C}$	400 - 600V	MAX.	10	$\mu\text{A}$
			$T_j = 125^\circ\text{C}$	400 - 600V		0.5	mA
			$T_j = 150^\circ\text{C}$	400 - 600V		3	

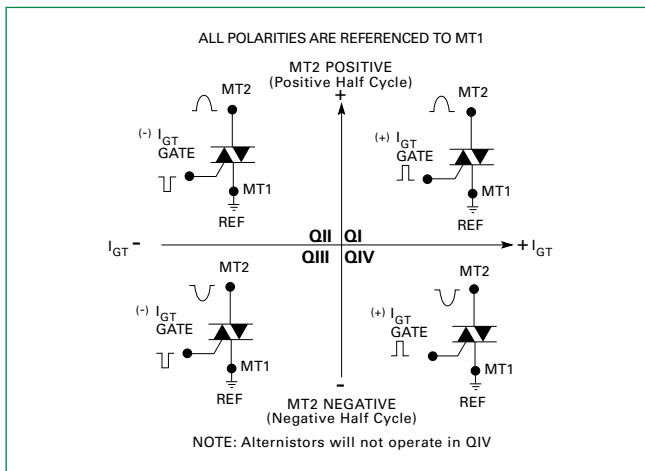
Note: xx=voltage/10, x = package, y = sensitivity

### Thermal Resistances

Symbol	Parameter	Value	Unit
$R_{\theta UC}$	Junction to case (AC) LJ/QJxx06Vyy LJ/QJxx06Dyy	1.3	$^\circ\text{C/W}$
$R_{\theta UA}$	Junction to ambient LJ/QJxx06Vyy LJ/QJxx06Dyy	70	$^\circ\text{C/W}$

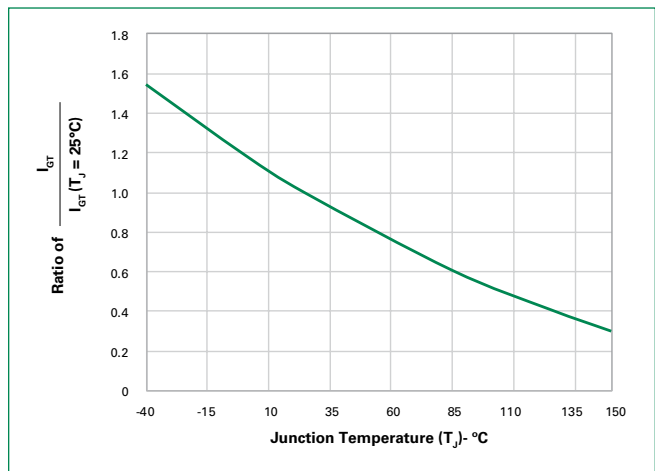
Note: xx=voltage/10, y = sensitivity

Figure 1: Definition of Quadrants



Note: Alternistors will not operate in QIV

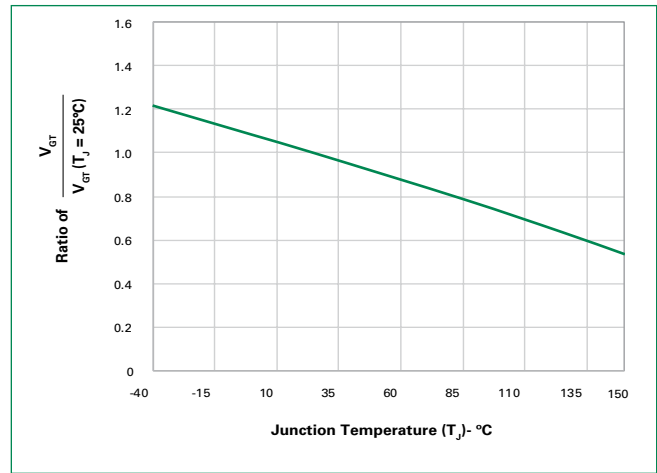
Figure 2: Normalized DC Gate Trigger Current for All Quadrants vs. Junction Temperature



**Figure 3: Normalized DC Holding Current vs. Junction Temperature**



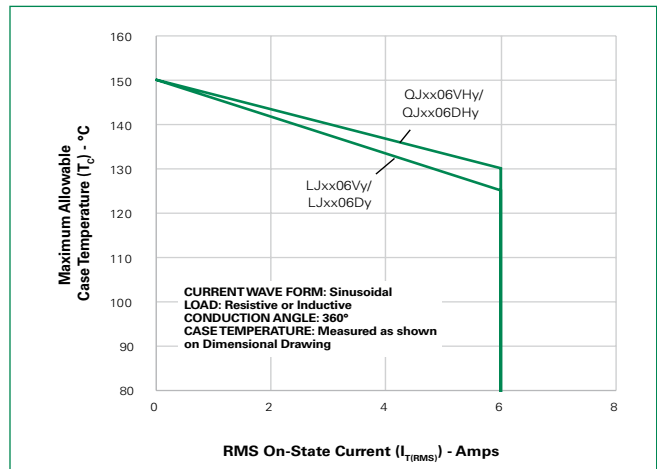
**Figure 4: Normalized DC Gate Trigger Voltage for All Quadrants vs. Junction Temperature**



**Figure 5: Power Dissipation (Typical) vs. RMS On-State Current**



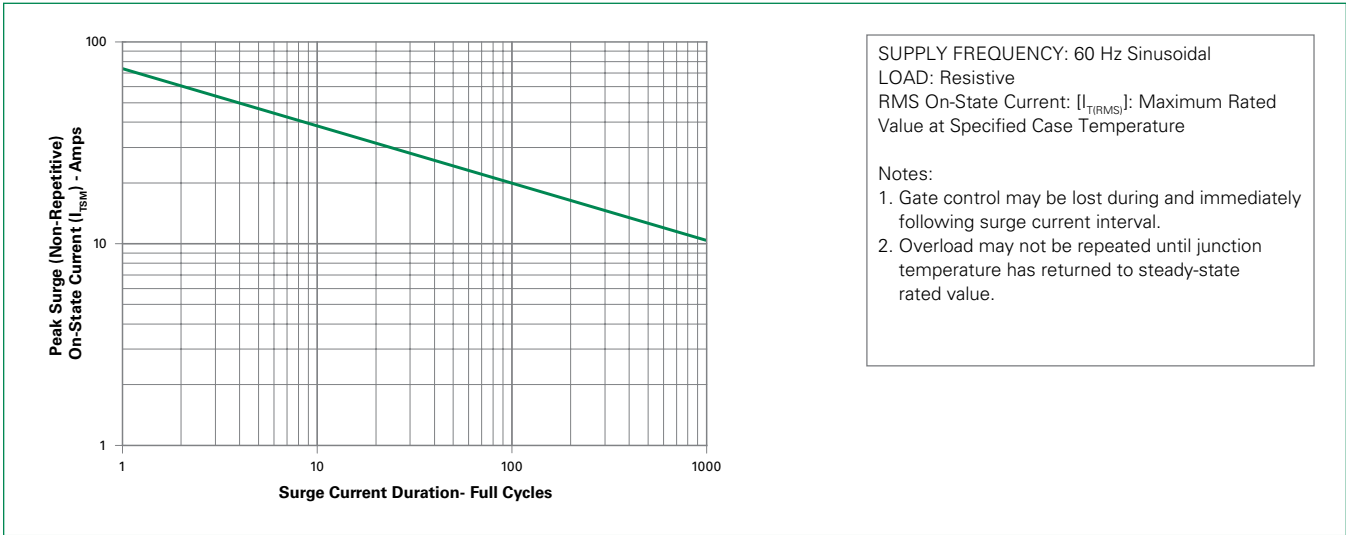
**Figure 6: Maximum Allowable Case Temperature vs. On-State Current**



**Figure 7: On-State Current vs. On-State Voltage (Typical)**

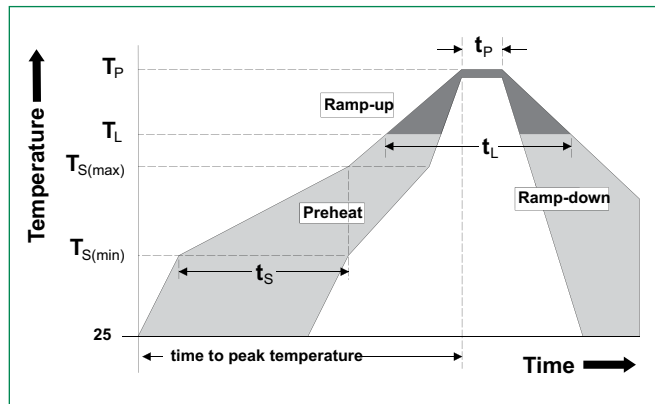


**Figure 8: Surge Peak On-State Current vs. Number of Cycles**



**Soldering Parameters**

<b>Reflow Condition</b>		Pb – Free assembly
<b>Pre Heat</b>	- Temperature Min ( $T_{s(min)}$ )	150°C
	- Temperature Max ( $T_{s(max)}$ )	200°C
	- Time (min to max) ( $t_s$ )	60 – 180 secs
<b>Average ramp up rate (Liquidus Temp) (<math>T_L</math>) to peak</b>		5°C/second max
<b><math>T_{s(max)}</math> to <math>T_L</math> - Ramp-up Rate</b>		5°C/second max
<b>Reflow</b>	- Temperature ( $T_L$ ) (Liquidus)	217°C
	- Time ( $t_L$ )	60 – 150 seconds
<b>Peak Temperature (<math>T_p</math>)</b>		$260^{+0/-5}$ °C
<b>Time within 5°C of actual peak Temperature (<math>t_p</math>)</b>		20 – 40 seconds
<b>Ramp-down Rate</b>		5°C/second max
<b>Time 25°C to peak Temperature (<math>T_p</math>)</b>		8 minutes Max.
<b>Do not exceed</b>		280°C



### Physical Specifications

<b>Terminal Finish</b>	100% Matte Tin-plated
<b>Body Material</b>	UL Recognized compound meeting flammability rating V-0.
<b>Terminal Material</b>	Copper Alloy

### Design Considerations

Careful selection of the correct component for the application's operating parameters and environment will go a long way toward extending the operating life of the Thyristor. Good design practice should limit the maximum continuous current through the main terminals to 75% of the component rating. Other ways to ensure long life for a power discrete semiconductor are proper heat sinking and selection of voltage ratings for worst case conditions. Overheating, overvoltage (including dv/dt), and surge currents are the main killers of semiconductors. Correct mounting, soldering, and forming of the leads also help protect against component damage.

### Environmental Specifications

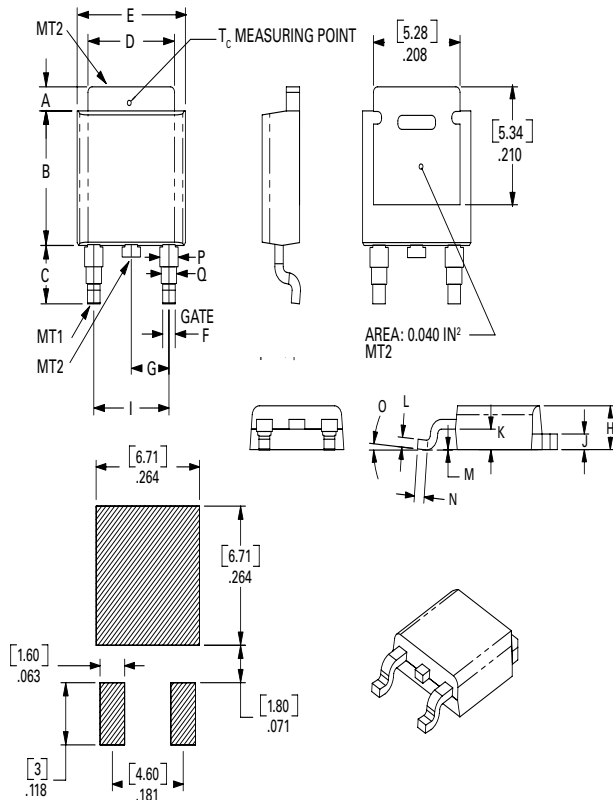
Test	Specifications and Conditions
<b>AC Blocking (<math>V_{DRM}</math>)</b>	MIL-STD-750, M-1040, Cond A Applied Peak AC voltage @ 150°C for 1008 hours
<b>Temperature Cycling</b>	MIL-STD-750, M-1051, 1000 cycles; -55°C to +150°C; 15-min dwell-time
<b>Temperature/Humidity</b>	EIA / JEDEC, JESD22-A101 1008 hours; 160V - DC: 85°C; 85% rel humidity
<b>High Temp Storage</b>	MIL-STD-750, M-1031, 1008 hours; 150°C
<b>Low-Temp Storage</b>	1008 hours; -40°C
<b>Resistance to Solder Heat</b>	MIL-STD-750 Method 2031
<b>Solderability</b>	ANSI/J-STD-002, category 3, Test A
<b>Lead Bend</b>	MIL-STD-750, M-2036 Cond E

### Dimensions – TO-251AA (V-Package) – V-PAK Through Hole



Dimension	Inches			Millimeters		
	Min	Typ	Max	Min	Typ	Max
A	0.037	0.040	0.043	0.94	1.01	1.09
B	0.235	0.242	0.245	5.97	6.15	6.22
C	0.350	0.361	0.375	8.89	9.18	9.53
D	0.205	0.208	0.213	5.21	5.29	5.41
E	0.255	0.262	0.265	6.48	6.66	6.73
F	0.027	0.031	0.033	0.69	0.80	0.84
G	0.087	0.090	0.093	2.21	2.28	2.36
H	0.085	0.092	0.095	2.16	2.34	2.41
I	0.176	0.180	0.184	4.47	4.57	4.67
J	0.018	0.020	0.023	0.46	0.51	0.58
K	0.035	0.037	0.039	0.90	0.95	1.00
L	0.018	0.020	0.023	0.46	0.52	0.58
P	0.042	0.047	0.052	1.06	1.20	1.32
Q	0.034	0.039	0.044	0.86	1.00	1.11
R	0.034	0.039	0.044	0.86	1.00	1.11
S	0.074	0.079	0.084	1.86	2.00	2.11

### Dimensions — TO-252AA (D-Package) — D-PAK Surface mount



Dimension	Inches			Millimeters		
	Min	Typ	Max	Min	Typ	Max
A	0.037	0.040	0.043	0.94	1.01	1.09
B	0.235	0.243	0.245	5.97	6.16	6.22
C	0.106	0.108	0.113	2.69	2.74	2.87
D	0.205	0.208	0.213	5.21	5.29	5.41
E	0.255	0.262	0.265	6.48	6.65	6.73
F	0.027	0.031	0.033	0.69	0.80	0.84
G	0.087	0.090	0.093	2.21	2.28	2.36
H	0.085	0.092	0.095	2.16	2.33	2.41
I	0.176	0.179	0.184	4.47	4.55	4.67
J	0.018	0.020	0.023	0.46	0.51	0.58
K	0.035	0.037	0.039	0.90	0.95	1.00
L	0.018	0.020	0.023	0.46	0.51	0.58
M	0.000	0.000	0.004	0.00	0.00	0.10
N	0.021	0.026	0.027	0.53	0.67	0.69
O	0°	0°	5°	0°	0°	5°
P	0.042	0.047	0.052	1.06	1.20	1.32
Q	0.034	0.039	0.044	0.86	1.00	1.11

### Product Selector

Part Number	Voltage		Gate Sensitivity Quadrants		Type	Package
	400V	600V	I - II - III	IV		
LJxx06D8	x	x	10	20	Sensitive Triac	TO-252 D-PAK
LJxx06V8	x	x	10	20	Sensitive Triac	TO-251 V-PAK
QJxx06DH2	x	x	10	-	Alternistor Triac	TO-252 D-PAK
QJxx06VH2	x	x	10	-	Alternistor Triac	TO-251 V-PAK
QJxx06DH3	x	x	20	-	Alternistor Triac	TO-252 D-PAK
QJxx06VH3	x	x	20	-	Alternistor Triac	TO-251 V-PAK
QJxx06DH4	x	x	35	-	Alternistor Triac	TO-252 D-PAK
QJxx06VH4	x	x	35	-	Alternistor Triac	TO-251 V-PAK

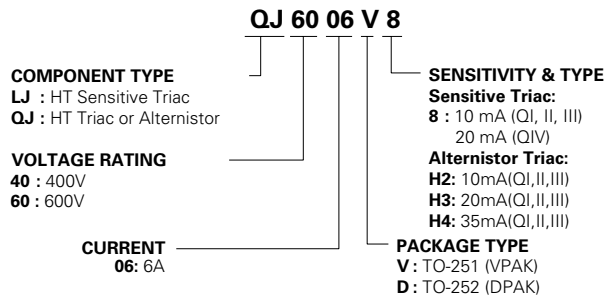
Note: xx = voltage/10

### Packing Options

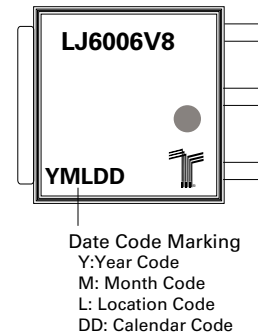
Part Number	Marking	Weight	Packing Mode	Base Quantity
LJxx06D8TP	LJxx06D8	0.3g	Tube Pack	750(75 per tube)
LJxx06D8RP	LJxx06D8	0.3g	Embossed Carrier	2500
QJxx06DH2TP	QJxx06DH2	0.3g	Tube Pack	750(75 per tube)
QJxx06DH2RP	QJxx06DH2	0.3g	Embossed Carrier	2500
QJxx06VH2TP	QJxx06VH2	0.3g	Tube Pack	750(75 per tube)
LJxx06V8TP	LJxx06V8	0.4g	Tube Pack	750(75 per tube)
QJxx06DH3TP	QJxx06DH3	0.3g	Tube Pack	750(75 per tube)
QJxx06DH3RP	QJxx06DH3	0.3g	Embossed Carrier	2500
QJxx06VH3TP	QJxx06VH3	0.4g	Tube Pack	750(75 per tube)
QJxx06DH4TP	QJxx06DH4	0.3g	Tube Pack	750(75 per tube)
QJxx06DH4RP	QJxx06DH4	0.3g	Embossed Carrier	2500
QJxx06VH4TP	QJxx06VH4	0.4g	Tube Pack	750(75 per tube)

Note: xx = voltage/10

### Part Numbering System

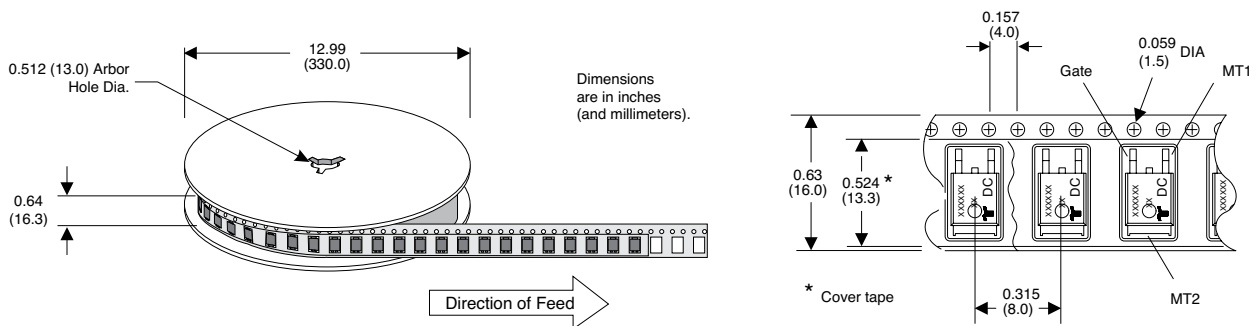


### Part Marking System



### TO-252 Embossed Carrier Reel Pack (RP) Specifications

Meets all EIA-481-2 Standards



**Disclaimer Notice** - Information furnished is believed to be accurate and reliable. However, users should independently evaluate the suitability of and test each product selected for their own applications. Littelfuse products are not designed for, and may not be used in, all applications. Read complete Disclaimer Notice at <http://www.littelfuse.com/disclaimer-electronics>.



Компания «Life Electronics» занимается поставками электронных компонентов импортного и отечественного производства от производителей и со складов крупных дистрибьюторов Европы, Америки и Азии.

С конца 2013 года компания активно расширяет линейку поставок компонентов по направлению коаксиальный кабель, кварцевые генераторы и конденсаторы (керамические, пленочные, электролитические), за счёт заключения дистрибьюторских договоров

Мы предлагаем:

- Конкуренспособные цены и скидки постоянным клиентам.
- Специальные условия для постоянных клиентов.
- Подбор аналогов.
- Поставку компонентов в любых объемах, удовлетворяющих вашим потребностям.
- Приемлемые сроки поставки, возможна ускоренная поставка.
- Доставку товара в любую точку России и стран СНГ.
- Комплексную поставку.
- Работу по проектам и поставку образцов.
- Формирование склада под заказчика.
- Сертификаты соответствия на поставляемую продукцию (по желанию клиента).
- Тестирование поставляемой продукции.
- Поставку компонентов, требующих военную и космическую приемку.
- Входной контроль качества.
- Наличие сертификата ISO.

В составе нашей компании организован Конструкторский отдел, призванный помогать разработчикам, и инженерам.

Конструкторский отдел помогает осуществить:

- Регистрацию проекта у производителя компонентов.
- Техническую поддержку проекта.
- Защиту от снятия компонента с производства.
- Оценку стоимости проекта по компонентам.
- Изготовление тестовой платы монтаж и пусконаладочные работы.



Тел: +7 (812) 336 43 04 (многоканальный)  
Email: [org@lifeelectronics.ru](mailto:org@lifeelectronics.ru)