

## Bicolor Symbol LED in 2.5 x 5 mm Untinted Top-Diffused Package

Color	Type	Technology	Angle of Half Intensity $\pm\varphi$
High efficiency red	TLSV5100	GaAsP on GaP	50°
Green	TLSV5100G	GaP on GaP	50°

### Features

- Even luminance of the emitting surface
- Ideal as flush mounted panel indicators
- For DC and pulse operation
- Color mixing possible due to separate anode terminals
- Luminous intensity selected into groups
- Categorized for green color
- Wide viewing angle
- Common cathode

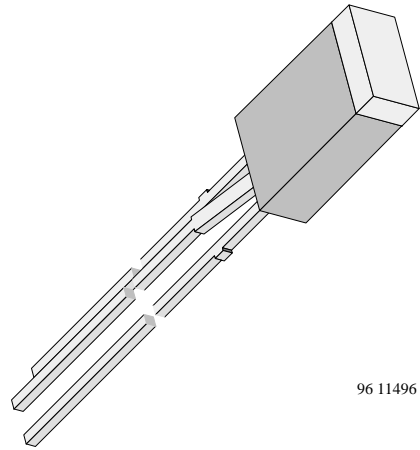

96 11496

### Applications

Indicating and illumination purposes

### Absolute Maximum Ratings

$T_{amb} = 25^{\circ}\text{C}$ , unless otherwise specified

**TLSV5100 , TLSV5100G ,**

Parameter	Test Conditions	Symbol	Value	Unit
Reverse voltage per diode		$V_R$	6	V
DC forward current per diode		$I_F$	30	mA
Surge forward current per diode	$t_p \leq 10 \mu\text{s}$	$I_{FSM}$	1	A
Power dissipation per diode	$T_{amb} \leq 55^{\circ}\text{C}$	$P_V$	100	mW
Total power dissipation	$T_{amb} \leq 55^{\circ}\text{C}$	$P_{tot}$	150	mW
Junction temperature		$T_j$	100	$^{\circ}\text{C}$
Storage temperature range		$T_{stg}$	-55 to +100	$^{\circ}\text{C}$
Soldering temperature	$t \leq 5 \text{ s}$ , 2 mm from body	$T_{sd}$	260	$^{\circ}\text{C}$
Thermal resistance junction/ambient per diode		$R_{thJA}$	450	K/W
Thermal resistance junction/ambient total		$R_{thJA}$	300	K/W

### Optical and Electrical Characteristics

$T_{amb} = 25^{\circ}\text{C}$ , unless otherwise specified

#### High efficiency red (TLSV5100)

Parameter	Test Conditions	Type	Symbol	Min	Typ	Max	Unit
Per diode							
Luminous intensity	$I_F = 10\text{ mA}$ , $I_{Vmin}/I_{Vmax} \geq 0.5$		$I_V$	0.63	1		mcd
Dominant wavelength	$I_F = 10\text{ mA}$		$\lambda_d$	612		625	nm
Peak wavelength	$I_F = 10\text{ mA}$		$\lambda_p$		635		nm
Angle of half intensity	$I_F = 10\text{ mA}$		$\phi$		$\pm 50$		deg
Forward voltage	$I_F = 20\text{ mA}$		$V_F$		2	3	V
Reverse voltage	$I_R = 10\text{ }\mu\text{A}$		$V_R$	6	15		V
Junction capacitance	$V_R = 0$ , $f = 1\text{ MHz}$		$C_j$		50		pF

#### Green (TLSV5100G)

Parameter	Test Conditions	Type	Symbol	Min	Typ	Max	Unit
Per diode							
Luminous intensity	$I_F = 10\text{ mA}$ , $I_{Vmin}/I_{Vmax} \geq 0.5$		$I_V$	0.63	1		mcd
Dominant wavelength	$I_F = 10\text{ mA}$		$\lambda_d$	562		575	nm
Peak wavelength	$I_F = 10\text{ mA}$		$\lambda_p$		565		nm
Angle of half intensity	$I_F = 10\text{ mA}$		$\phi$		$\pm 50$		deg
Forward voltage	$I_F = 20\text{ mA}$		$V_F$		2.4	3	V
Reverse voltage	$I_R = 10\text{ }\mu\text{A}$		$V_R$	6	15		V
Junction capacitance	$V_R = 0$ , $f = 1\text{ MHz}$		$C_j$		50		pF

### Typical Characteristics ( $T_{amb} = 25^{\circ}\text{C}$ , unless otherwise specified)

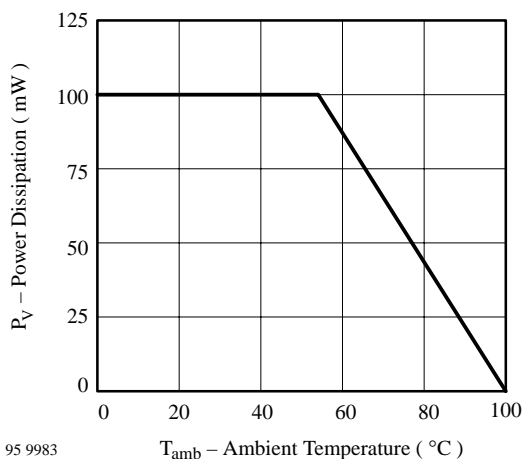

Figure 1 Power Dissipation vs. Ambient Temperature

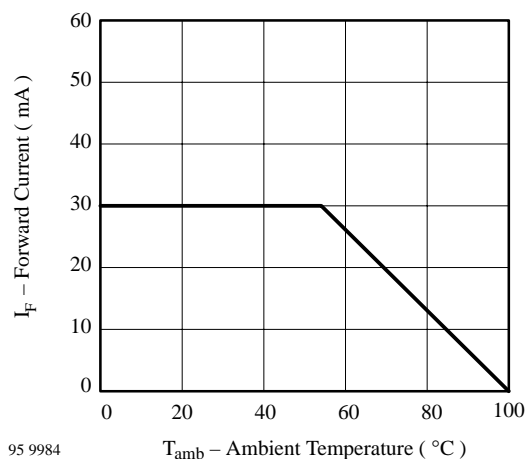
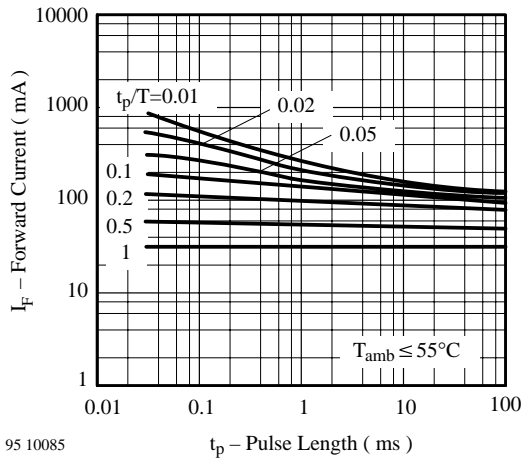
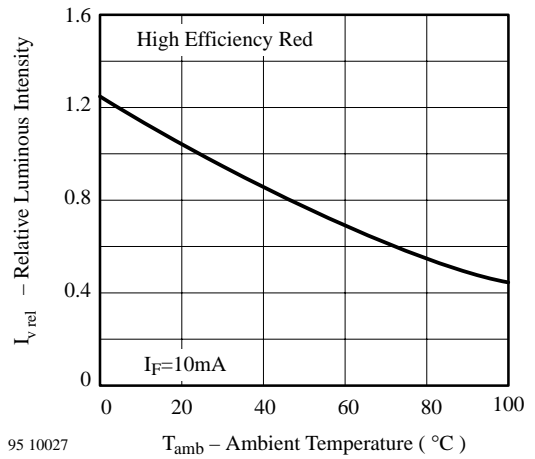

Figure 2 Forward Current vs. Ambient Temperature



95 10085

Figure 3 Forward Current vs. Pulse Length



95 10027

Figure 6 Rel. Luminous Intensity vs. Ambient Temperature

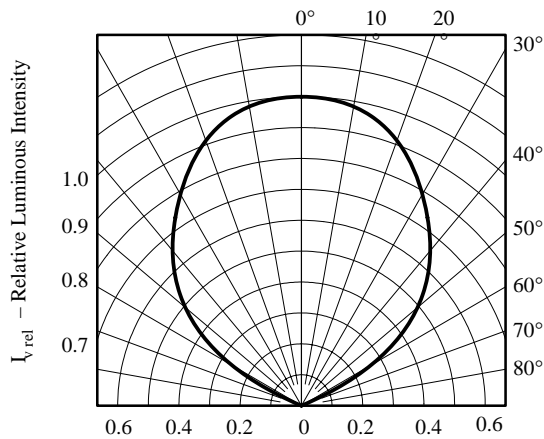

95 10082

Figure 4 Rel. Luminous Intensity vs. Angular Displacement

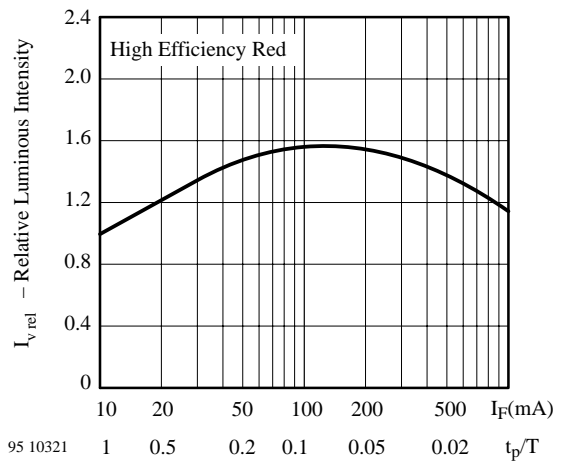

95 10321

Figure 7 Rel. Lumin. Intensity vs. Forw. Current/Duty Cycle

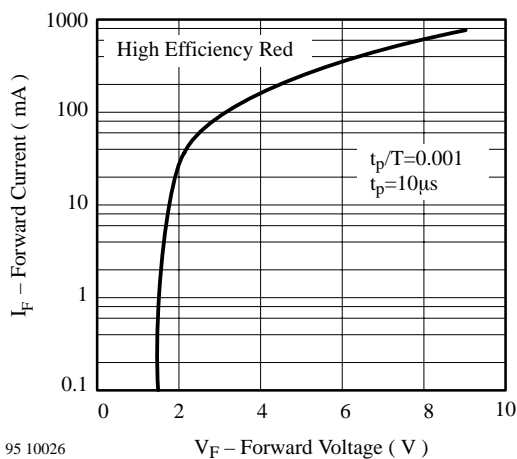

95 10026

Figure 5 Forward Current vs. Forward Voltage

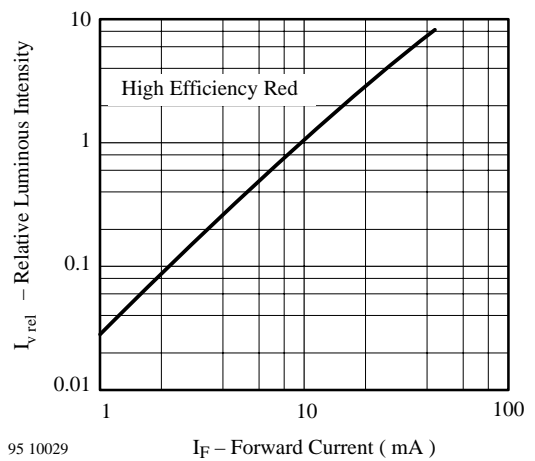

95 10029

Figure 8 Relative Luminous Intensity vs. Forward Current

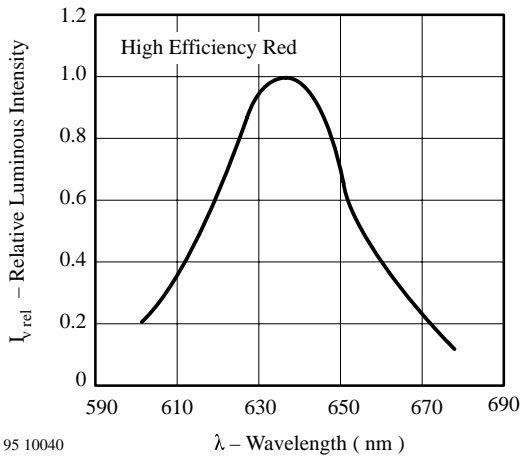

95 10040

Figure 9 Relative Luminous Intensity vs. Wavelength

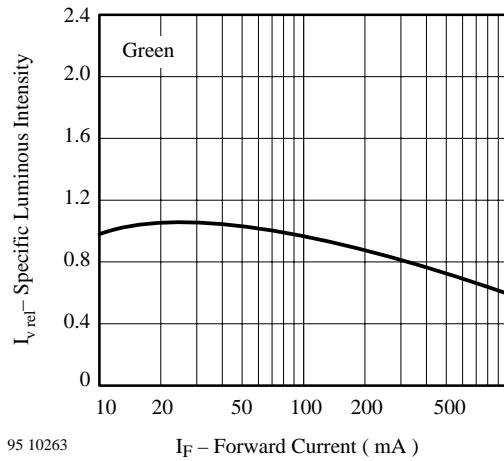

95 10263

Figure 12 Specific Luminous Intensity vs. Forward Current

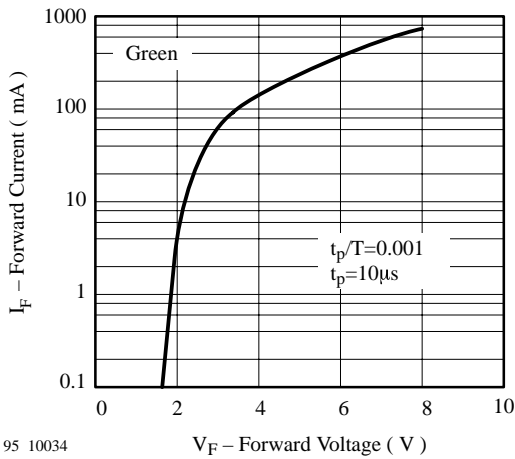

95 10034

Figure 10 Forward Current vs. Forward Voltage

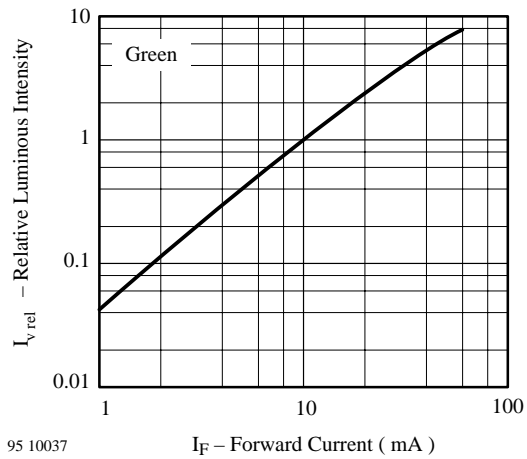

95 10037

Figure 13 Relative Luminous Intensity vs. Forward Current

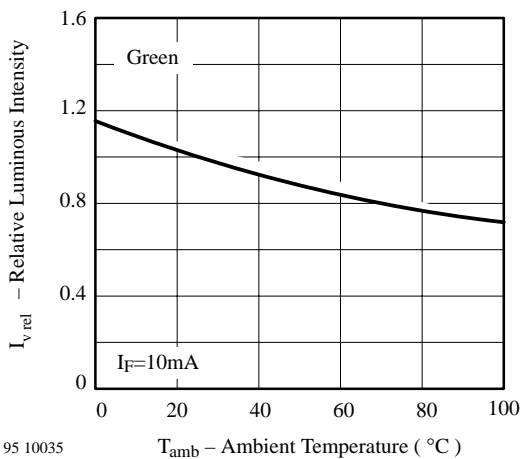

95 10035

Figure 11 Rel. Luminous Intensity vs. Ambient Temperature

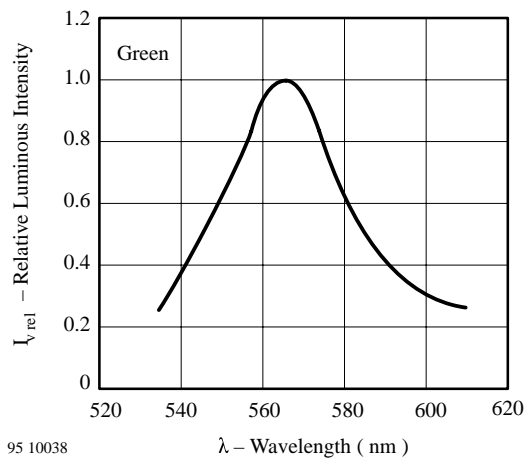

95 10038

Figure 14 Relative Luminous Intensity vs. Wavelength

**Dimensions in mm**

95 11327

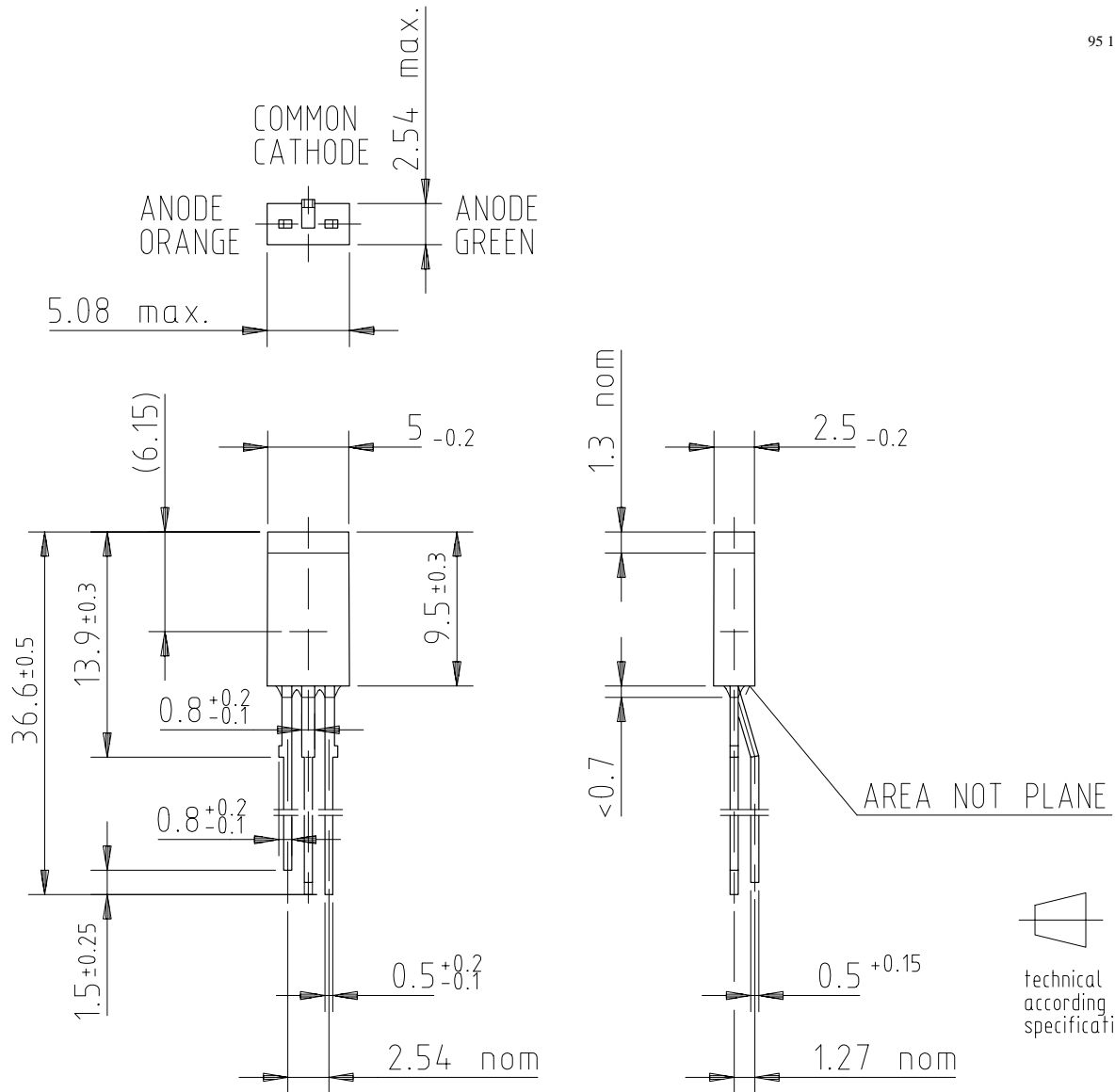

### Ozone Depleting Substances Policy Statement

It is the policy of **Vishay Semiconductor GmbH** to

1. Meet all present and future national and international statutory requirements.
2. Regularly and continuously improve the performance of our products, processes, distribution and operating systems with respect to their impact on the health and safety of our employees and the public, as well as their impact on the environment.

It is particular concern to control or eliminate releases of those substances into the atmosphere which are known as ozone depleting substances (ODSs).

The Montreal Protocol (1987) and its London Amendments (1990) intend to severely restrict the use of ODSs and forbid their use within the next ten years. Various national and international initiatives are pressing for an earlier ban on these substances.

**Vishay Semiconductor GmbH** has been able to use its policy of continuous improvements to eliminate the use of ODSs listed in the following documents.

1. Annex A, B and list of transitional substances of the Montreal Protocol and the London Amendments respectively
2. Class I and II ozone depleting substances in the Clean Air Act Amendments of 1990 by the Environmental Protection Agency (EPA) in the USA
3. Council Decision 88/540/EEC and 91/690/EEC Annex A, B and C (transitional substances) respectively.

**Vishay Semiconductor GmbH** can certify that our semiconductors are not manufactured with ozone depleting substances and do not contain such substances.

**We reserve the right to make changes to improve technical design and may do so without further notice.**

Parameters can vary in different applications. All operating parameters must be validated for each customer application by the customer. Should the buyer use Vishay-Telefunken products for any unintended or unauthorized application, the buyer shall indemnify Vishay-Telefunken against all claims, costs, damages, and expenses, arising out of, directly or indirectly, any claim of personal damage, injury or death associated with such unintended or unauthorized use.

Vishay Semiconductor GmbH, P.O.B. 3535, D-74025 Heilbronn, Germany  
Telephone: 49 (0) 7131 67 2831, Fax number: 49 (0) 7131 67 2423

Компания «Life Electronics» занимается поставками электронных компонентов импортного и отечественного производства от производителей и со складов крупных дистрибьюторов Европы, Америки и Азии.

С конца 2013 года компания активно расширяет линейку поставок компонентов по направлению коаксиальный кабель, кварцевые генераторы и конденсаторы (керамические, пленочные, электролитические), за счёт заключения дистрибьюторских договоров

Мы предлагаем:

- Конкурентоспособные цены и скидки постоянным клиентам.
- Специальные условия для постоянных клиентов.
- Подбор аналогов.
- Поставку компонентов в любых объемах, удовлетворяющих вашим потребностям.
- Приемлемые сроки поставки, возможна ускоренная поставка.
- Доставку товара в любую точку России и стран СНГ.
- Комплексную поставку.
- Работу по проектам и поставку образцов.
- Формирование склада под заказчика.
- Сертификаты соответствия на поставляемую продукцию (по желанию клиента).
- Тестирование поставляемой продукции.
- Поставку компонентов, требующих военную и космическую приемку.
- Входной контроль качества.
- Наличие сертификата ISO.

В составе нашей компании организован Конструкторский отдел, призванный помогать разработчикам, и инженерам.

Конструкторский отдел помогает осуществить:

- Регистрацию проекта у производителя компонентов.
- Техническую поддержку проекта.
- Защиту от снятия компонента с производства.
- Оценку стоимости проекта по компонентам.
- Изготовление тестовой платы монтаж и пусконаладочные работы.



Тел: +7 (812) 336 43 04 (многоканальный)

Email: [org@lifeelectronics.ru](mailto:org@lifeelectronics.ru)