



Typical Applications

The HMC631LP3(E) is ideal for:

- Cellular/3G & WiMAX Systems
- Wireless Infrastructure HPA & MCPA Error Correction
- Pre-Distortion or Feed-Forward Linearization
- Beam Forming & Nulling Circuits

Features

- Continuous Phase Control: 360°
- Continuous Gain Control: 40 dB
- Output Noise Floor: -160 dBm/Hz
- Input IP3: +35 dBm
- 16 Lead 3x3mm SMT Package: 9mm²

Functional Diagram

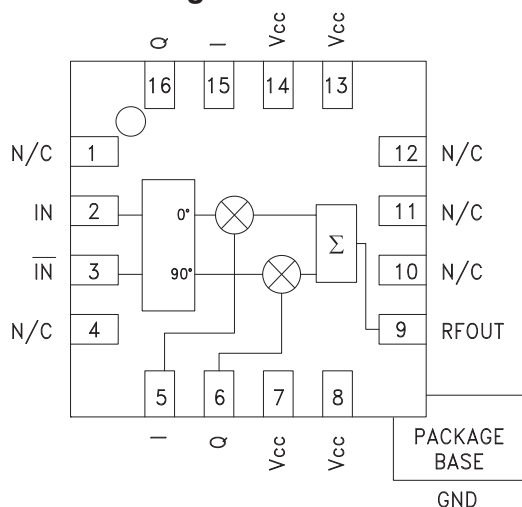

General Description

The HMC631LP3 & HMC631LP3E are high dynamic range Vector Modulator RFICs which are targeted for RF predistortion and feed-forward cancellation circuits, as well as RF cancellation, beam forming and amplitude/phase correction circuits. The I & Q ports of the HMC631LP3(E) can be used to continuously vary the phase and amplitude of RF signals by up to 360 degrees and 40 dB respectively, while supporting a 3 dB modulation bandwidth of 200 MHz. With an output IP3 of +26 dBm and output noise floor of -160 dBm/Hz (at maximum gain setting), the IP3/noise floor ratio is 186 dB.

10

MODULATORS - SMT

Electrical Specifications, $T_A = +25^\circ\text{C}$, $V_{CC} = +8\text{V}$

Parameter	Min.	Typ.	Max.	Min.	Typ.	Max.	Units
Frequency Range		1.8 - 2.2		2.2 - 2.7			GHz
Maximum Gain ⁽¹⁾	-11	-9			-11		dB
Gain Variation Over Temperature		0.016	0.025		0.016		dB / °C
Gain Flatness Across Any 60 MHz Bandwidth		0.15			0.4		dB
Gain Range		40			40		dB
Input Return Loss		9			9		dB
Output Return Loss		13			10		dB
Input Power for 1dB Compression (P1dB)	15	18			21		dBm
Input Third Order Intercept (IP3)		35			37		dBm
Output Noise		-160			-160		dBm/Hz
Control Port Bandwidth (-3 dB)		200			200		MHz
Control Port Impedance		1.45k			1.45k		Ohms
Control Port Capacitance		0.22			0.22		pF
Control Voltage Range		+0.5 to +2.5			+0.5 to +2.5		Vdc
Group Delay Variation Over 60 MHz Bandwidth		20			20		ps
Supply Current (I _{cc})		93			93		mA

Unless otherwise noted, measurements are made @ max. gain setting and 45° phase setting. See application circuit for details.

⁽¹⁾Includes loss of input balun (0.8 dB typ.)



**GaAs HBT VECTOR
MODULATOR 1.8 - 2.7 MHz**

Maximum Gain vs. Temperature

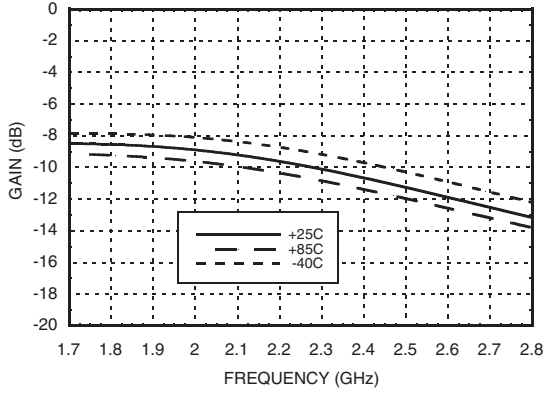

Maximum Gain vs. Supply Voltage

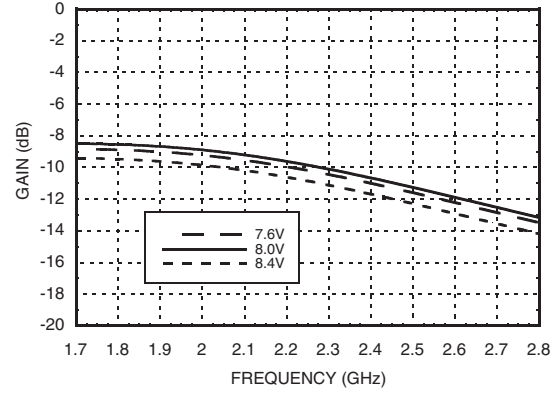

Gain vs. Phase Settings @ F= 2 GHz

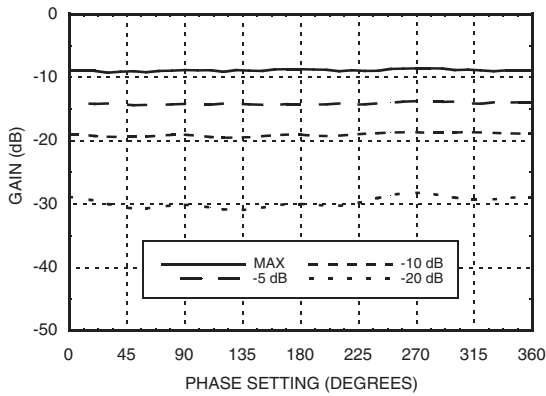

**Phase vs. Phase Settings @ F= 2 GHz
vs. Various Gain Settings**

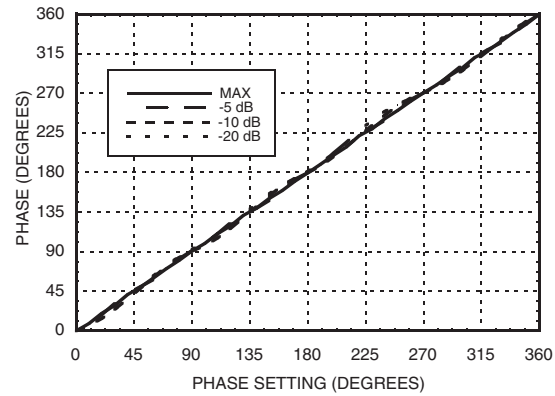

Input Return Loss vs. Temperature

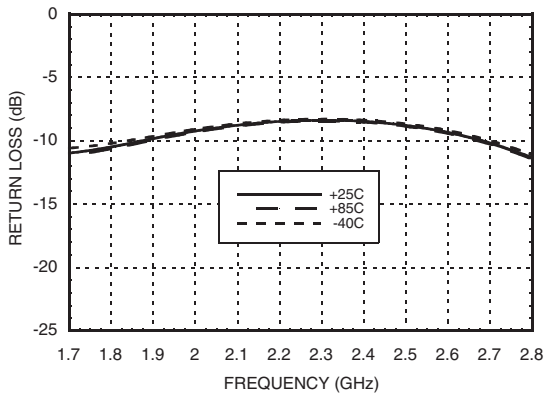

Output Return Loss vs. Temperature

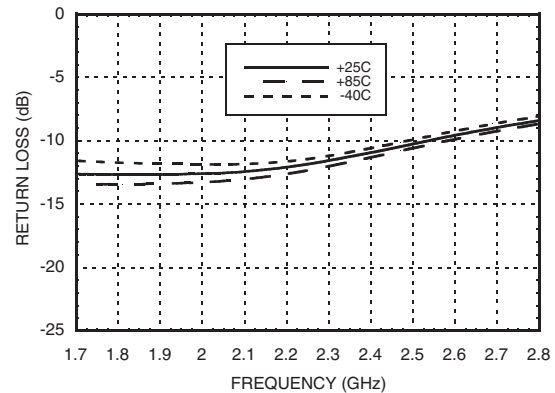

Information furnished by Analog Devices is believed to be accurate and reliable. However, no responsibility is assumed by Analog Devices for its use, nor for any infringements of patents or other rights of third parties that may result from its use. Specifications subject to change without notice. No license is granted by implication or otherwise under any patent or patent rights of Analog Devices. Trademarks and registered trademarks are the property of their respective owners.

For price, delivery, and to place orders: Analog Devices, Inc., One Technology Way, P.O. Box 9106, Norwood, MA 02062-9106 Phone: 781-329-4700 • Order online at www.analog.com Application Support: Phone: 1-800-ANALOG-D



**GaAs HBT VECTOR
MODULATOR 1.8 - 2.7 MHz**

Output Noise vs. Temperature

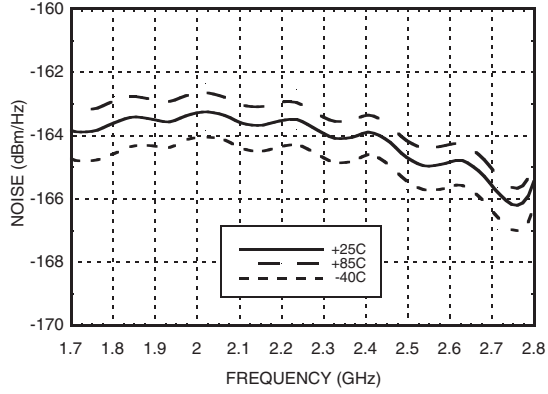

Output Noise vs. Phase Settings @ F= 2 GHz

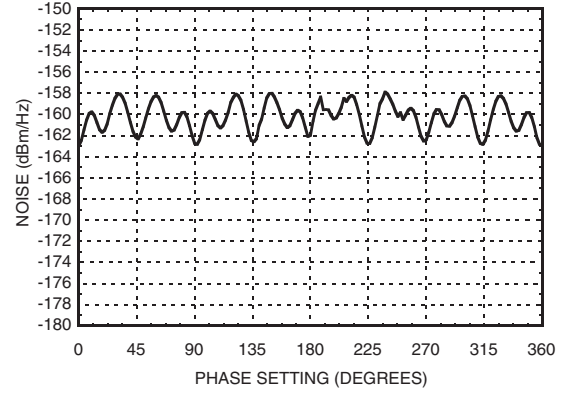

Input P1dB vs. Temperature

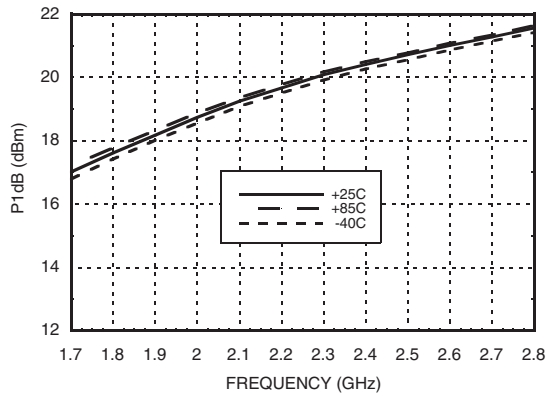

Input IP3 vs. Temperature

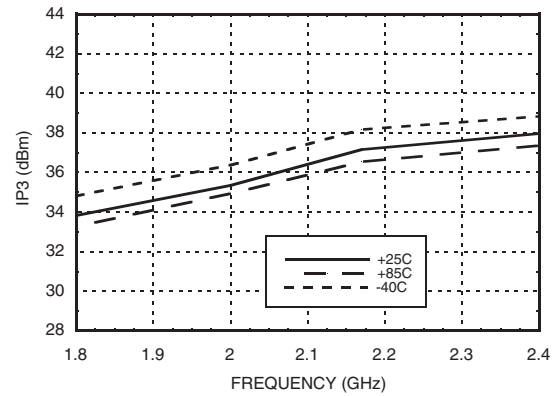

Group Delay

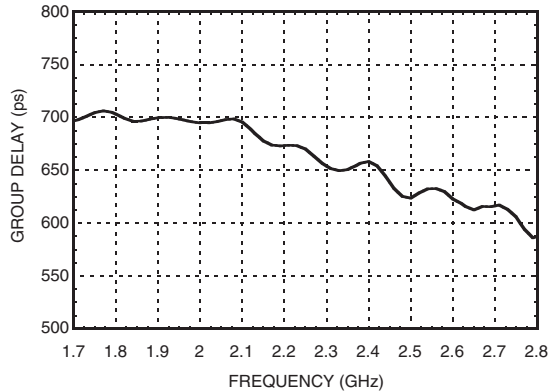

Linear Gain vs. Phase Setting

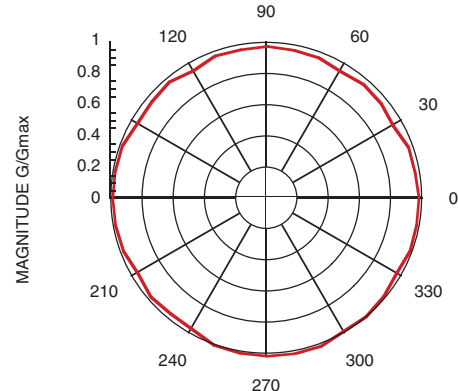

Information furnished by Analog Devices is believed to be accurate and reliable. However, no responsibility is assumed by Analog Devices for its use, nor for any infringements of patents or other rights of third parties that may result from its use. Specifications subject to change without notice. No license is granted by implication or otherwise under any patent or patent rights of Analog Devices. Trademarks and registered trademarks are the property of their respective owners.

For price, delivery, and to place orders: Analog Devices, Inc., One Technology Way, P.O. Box 9106, Norwood, MA 02062-9106 Phone: 781-329-4700 • Order online at www.analog.com Application Support: Phone: 1-800-ANALOG-D



Typical Supply Current vs. Vcc

Vcc (V)	Icc (mA)
7.6	88
8.0	93
8.4	99

Note:
Modulator will operate over full voltage range shown above.



**ELECTROSTATIC SENSITIVE DEVICE
OBSERVE HANDLING PRECAUTIONS**

Absolute Maximum Ratings

RF Input (Vcc = +8V)	27 dBm
Supply Voltage (Vcc)	+10V
I & Q Input	-0.5V to +5V
Junction Temperature (Tc)	135 °C
Continuous P _{diss} (T = 85°C) (Derate 34 mW/°C above 85°C)	1.7 W
Thermal Resistance (R _{th}) (junction to ground paddle)	29.6 °C/W
Storage Temperature	-65 to +150 °C
Operating Temperature	-40 to +85 °C

Outline Drawing

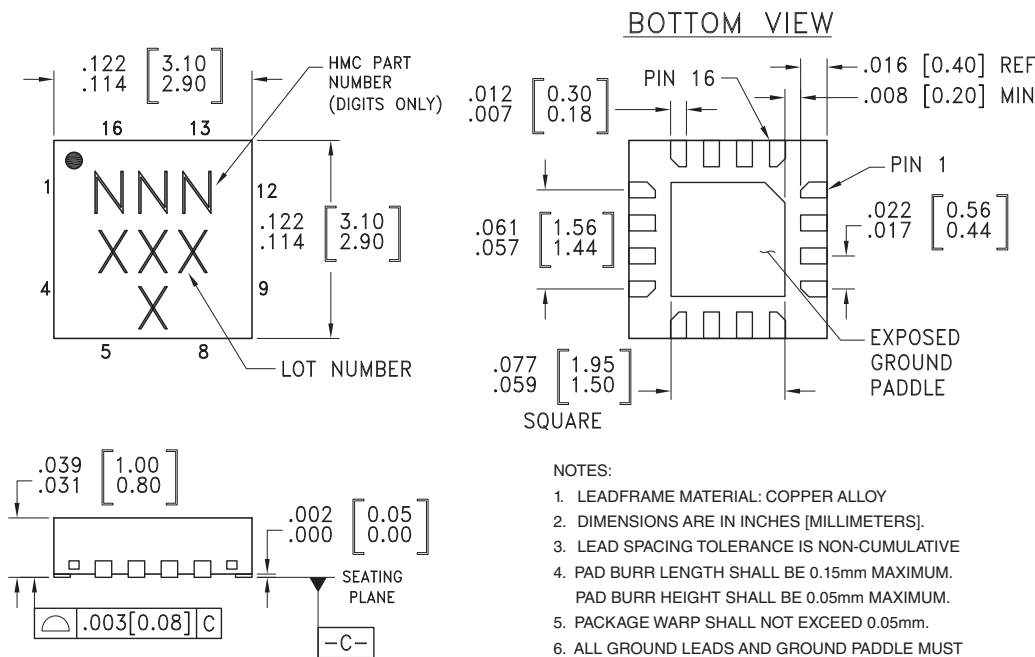

Package Information

Part Number	Package Body Material	Lead Finish	MSL Rating	Package Marking ^[3]
HMC631LP3	Low Stress Injection Molded Plastic	Sn/Pb Solder	MSL1 ^[1]	631 XXXX
HMC631LP3E	RoHS-compliant Low Stress Injection Molded Plastic	100% matte Sn	MSL1 ^[2]	631 XXXX

[1] Max peak reflow temperature of 235 °C

[2] Max peak reflow temperature of 260 °C

[3] 4-Digit lot number XXXX



Pin Description

Pin Number	Function	Description	Interface Schematic
1, 4, 10 - 12	N/C	No connection. These pins may be connected to RF ground. Performance will not be affected	
2, 3	IN, \bar{IN}	Differential RF inputs, 100 Ohms differential impedance. (i.e. each pin is 50 Ohms to ground). Must be DC blocked.	
5, 15	I	In-phase control input. Pins 5 and 15 are redundant. Either input can be used.	
6, 16	Q	Quadrature control input. Pins 6 and 16 are redundant. Either input can be used.	
7, 8, 13, 14	Vcc	Supply Voltage, pins are DC connected on-chip. It is only necessary to supply Vcc to any 1 of the 4 pins, but all 4 pins must be bypassed to ground. (See application circuit).	
9	RFOUT	RF Output: Must be DC blocked.	
	GND	Ground: Backside of package has exposed metal ground paddle which must be connected to RF/DC ground.	



Application Circuit

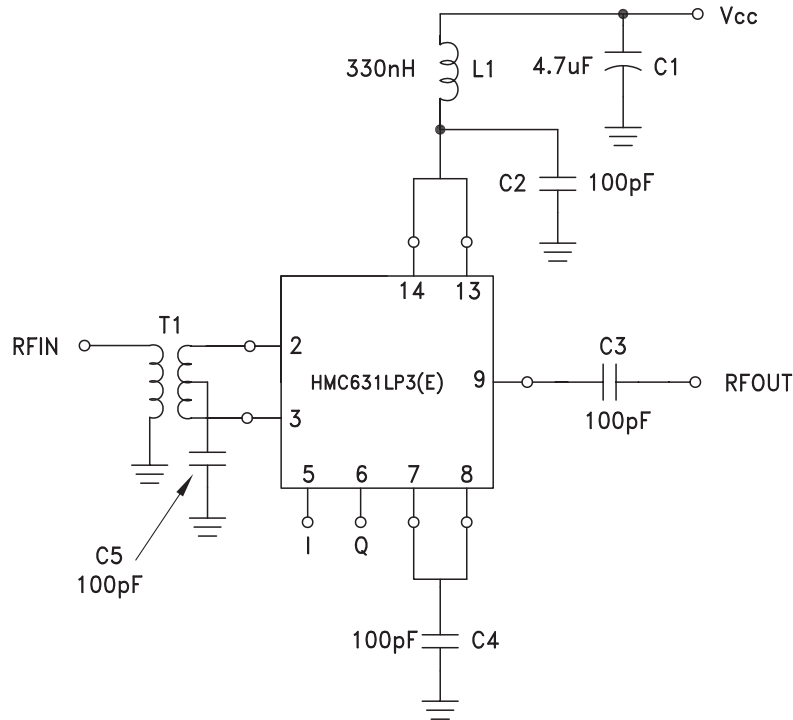

* Pins 15 & 16 are redundant I & Q inputs.

Gain and Phase control are applied through the I and Q control ports. For a given linear gain (G) and phase (θ) setting, the voltages applied to these ports in all measurements are calculated as follows:

$$I(G, \theta) = V_{mi} + 1.0V \frac{G}{G_{max}} \cos(\theta)$$

$$Q(G, \theta) = V_{mq} + 1.0V \frac{G}{G_{max}} \sin(\theta)$$

Where V_{mi} and V_{mq} are the I and Q voltage settings corresponding to maximum isolation at room temperature and $F = 2$ GHz.

Note that $G = 10^x$ and $G_{max} = 10^y$ where $x = \frac{\text{Gain Setting (dB)}}{20}$ and $y = \frac{\text{Max Gain Setting (dB)}}{20}$. Nominally $V_{mi} = V_{mq} = 1.5V$, $G_{max} = 0.316$.



GaAs HBT VECTOR MODULATOR 1.8 - 2.7 MHz

Evaluation PCB

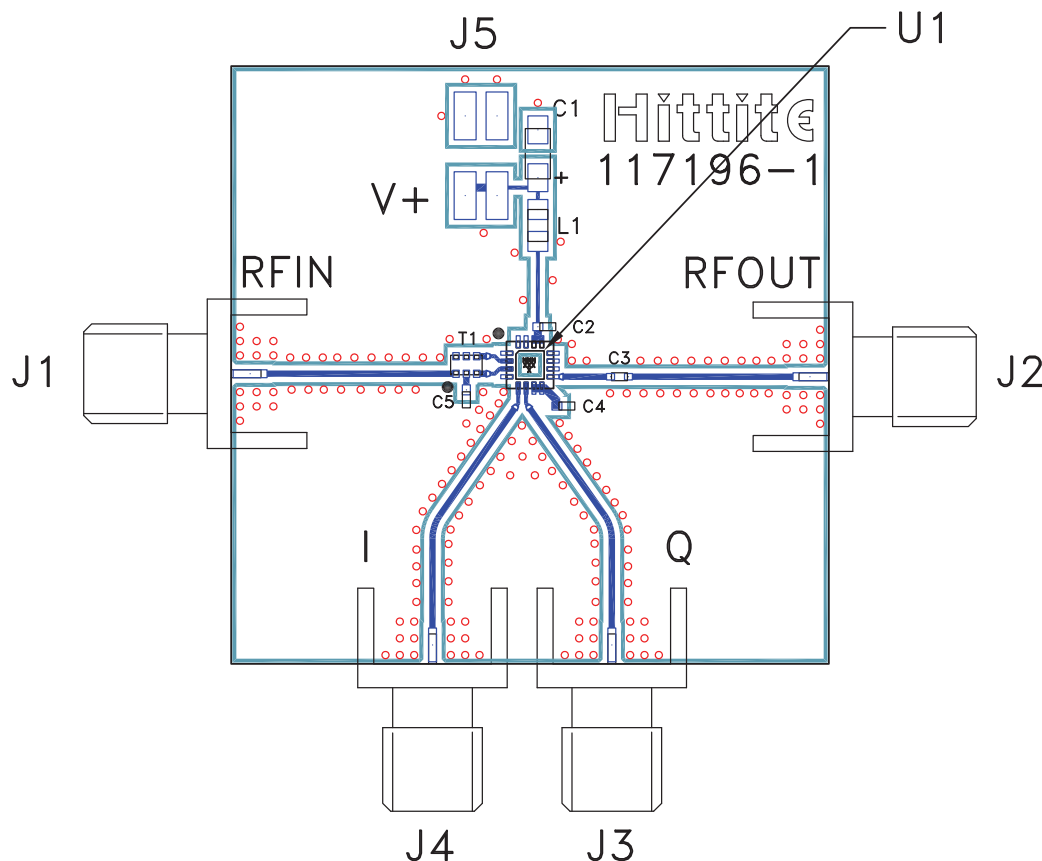

List of Materials for Evaluation PCB 117201 [1]

Item	Description
J1 - J4	PCB Mount SMA Connector
J5	2 mm DC Header
C1	4.7 μ F Capacitor, Tantalum
C2 - C5	100 pF Capacitor, 0402 Pkg.
T1	Balun, 0805 Pkg. ANAREN BD1722J50100A
L1	330 nH Inductor, 0805 Pkg.
U1	HMC631LP3(E) Vector Modulator
PCB [2]	117196 Evaluation PCB

[1] Reference this number when ordering complete evaluation PCB

[2] Circuit Board Material: Rogers 4350, Er = 3.48

The circuit board used in the final application should use RF circuit design techniques. Signal lines should have 50 ohm impedance while the package ground leads and exposed paddle should be connected directly to the ground plane similar to that shown. A sufficient number of via holes should be used to connect the top and bottom ground planes. The evaluation board should be mounted to an appropriate heat sink. The evaluation circuit board shown is available from Hittite upon request.



Notes:

HMC631LP3 / 631LP3E

v00.1007

**GaAs HBT VECTOR
MODULATOR 1.8 - 2.7 MHz**

10

MODULATORS - SMT

Information furnished by Analog Devices is believed to be accurate and reliable. However, no responsibility is assumed by Analog Devices for its use, nor for any infringements of patents or other rights of third parties that may result from its use. Specifications subject to change without notice. No license is granted by implication or otherwise under any patent or patent rights of Analog Devices. Trademarks and registered trademarks are the property of their respective owners.

For price, delivery, and to place orders: Analog Devices, Inc.,
One Technology Way, P.O. Box 9106, Norwood, MA 02062-9106
Phone: 781-329-4700 • Order online at www.analog.com
Application Support: Phone: 1-800-ANALOG-D

Компания «Life Electronics» занимается поставками электронных компонентов импортного и отечественного производства от производителей и со складов крупных дистрибьюторов Европы, Америки и Азии.

С конца 2013 года компания активно расширяет линейку поставок компонентов по направлению коаксиальный кабель, кварцевые генераторы и конденсаторы (керамические, пленочные, электролитические), за счёт заключения дистрибьюторских договоров

Мы предлагаем:

- Конкурентоспособные цены и скидки постоянным клиентам.
- Специальные условия для постоянных клиентов.
- Подбор аналогов.
- Поставку компонентов в любых объемах, удовлетворяющих вашим потребностям.
- Приемлемые сроки поставки, возможна ускоренная поставка.
- Доставку товара в любую точку России и стран СНГ.
- Комплексную поставку.
- Работу по проектам и поставку образцов.
- Формирование склада под заказчика.
- Сертификаты соответствия на поставляемую продукцию (по желанию клиента).
- Тестирование поставляемой продукции.
- Поставку компонентов, требующих военную и космическую приемку.
- Входной контроль качества.
- Наличие сертификата ISO.

В составе нашей компании организован Конструкторский отдел, призванный помогать разработчикам, и инженерам.

Конструкторский отдел помогает осуществить:

- Регистрацию проекта у производителя компонентов.
- Техническую поддержку проекта.
- Защиту от снятия компонента с производства.
- Оценку стоимости проекта по компонентам.
- Изготовление тестовой платы монтаж и пусконаладочные работы.



Тел: +7 (812) 336 43 04 (многоканальный)
Email: org@lifeelectronics.ru