

### Applications

- Defense & Aerospace
- Broadband Wireless

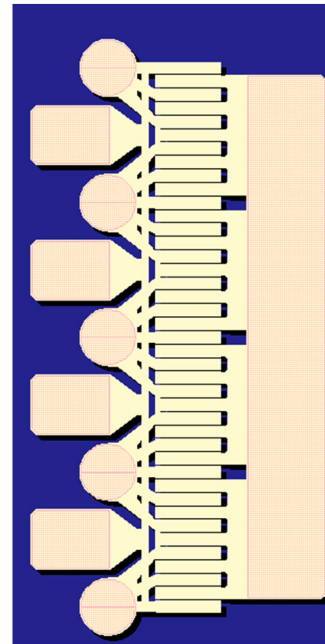

### Product Features

- Frequency Range: DC - 18 GHz
- 44.3 dBm Nominal  $P_{SAT}$  at 6 GHz
- 64.4% Maximum PAE at 6 GHz
- 17.6 dB Linear Gain at 6 GHz
- Bias:  $V_D = 12 - 32$  V,  $I_{DQ} = 100 - 250$  mA
- Technology: QGaN25 on SiC
- Chip Dimensions: 0.82 x 1.44 x 0.10 mm

### Functional Block Diagram

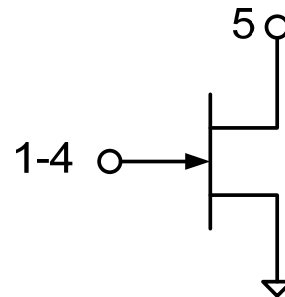

### General Description

The Qorvo TGF2023-2-05 is a discrete 5 mm GaN on SiC HEMT which operates from DC-18 GHz. The TGF2023-2-05 is designed using Qorvo's proven QGaN25 production process. This process features advanced field plate techniques to optimize microwave power and efficiency at high drain bias operating conditions.

The TGF2023-2-05 typically provides 44.3 dBm of saturated output power with power gain of 14.6 dB at 6 GHz. The maximum power added efficiency is 64.4 % which makes the TGF2023-2-05 appropriate for high efficiency applications.

Lead-free and RoHS compliant

### Pad Configuration

Pad No.	Symbol
1-4	$V_G$ / RF IN
5	$V_D$ / RF OUT
Backside	Source / Ground

### Ordering Information

Part	ECCN	Description
TGF2023-2-05	3A001b.3.b	25 Watt GaN HEMT

### Absolute Maximum Ratings

Parameter	Value
Drain to Gate Voltage ( $V_{DG}$ )	100 V
Gate Voltage Range ( $V_G$ )	-10 to 0 V
Drain Current ( $I_D$ )	5 A
Gate Current ( $I_G$ )	-5 to 14 mA
Power Dissipation, CW ( $P_D$ )	See graph on pg.5.
CW Input Power ( $P_{IN}$ )	+37 dBm
Channel Temperature ( $T_{CH}$ )	275 °C
Mounting Temperature	320 °C
Storage Temperature	-65 to 150 °C

Operation of this device outside the parameter ranges given above may cause permanent damage. These are stress ratings only, and functional operation of the device at these conditions is not implied.

### Recommended Operating Conditions<sup>(1)</sup>

Parameter	Value
Drain Voltage Range ( $V_D$ )	12 - 40 V
Drain Quiescent Current ( $I_{DQ}$ )	250 mA
Drain Current Under RF Drive ( $I_D$ ) <sup>2</sup>	0.5 A (Typ.)
Gate Voltage ( $V_G$ )	-3.0 V (Typ.)
Channel Temperature ( $T_{CH}$ )	225 °C (Max.)
Dissipation Power, CW ( $P_D$ )	16 W
Dissipation Power, Pulsed ( $P_D$ ) <sup>2,3</sup>	17.5 W

1. Electrical specifications are measured at specified test conditions. Specifications are not guaranteed over all recommended operating conditions.

2. 2.66 mS Pulse Width, 10% Duty Cycle

3. Carrier plate temperature is at 85 °C.

### Model RF Characterization – Optimum Power Tune

Simulation conditions: T = 25 °C, Signal Duty Cycle = 10%

Parameter	Typical Value								Units
	3		6		8		10		
Frequency (F)	3		6		8		10		GHz
Drain Voltage ( $V_D$ )	28	28	28	28	28	28	28	28	V
Bias Current ( $I_{DQ}$ )	100	250	100	250	100	250	100	250	mA
Output P3dB ( $P_{3dB}$ )	44.2	44.1	44.4	44.3	44.4	44.3	44.4	44.3	dBm
PAE @ P3dB ( $PAE_{3dB}$ )	61.7	60.9	60	59.2	57.4	57.5	55.3	55.4	%
Gain @ P3dB ( $G_{3dB}$ )	19.1	20	13.8	14.6	11.5	12.2	9.7	10.4	dB
Parallel Resistance <sup>(1)</sup> ( $R_p$ )	63.5	63.6	61.4	60.6	57.9	58	53.1	52.6	$\Omega$ ·mm
Parallel Capacitance <sup>(1)</sup> ( $C_p$ )	0.268	0.275	0.297	0.303	0.297	0.303	0.320	0.325	pF/mm
Load Reflection Coefficient <sup>(2)</sup> ( $\Gamma_L$ )	0.44 $\angle$ 17°	0.44 $\angle$ 17°	0.46 $\angle$ 37°	0.45 $\angle$ 37°	0.46 $\angle$ 48°	0.46 $\angle$ 49°	0.47 $\angle$ 62°	0.47 $\angle$ 63°	--

Notes:

1. Large signal equivalent output network (normalized).
2. Characteristic Impedance ( $Z_0$ ) = 5  $\Omega$ .

### Model RF Characterization – Optimum Efficiency Tune

Simulation conditions: T = 25 °C, Signal Duty Cycle = 10%

Parameter	Typical Value								Units
	3		6		8		10		
Frequency (F)	3		6		8		10		GHz
Drain Voltage ( $V_D$ )	28	28	28	28	28	28	28	28	V
Bias Current ( $I_{DQ}$ )	100	250	100	250	100	250	100	250	mA
Output P3dB ( $P_{3dB}$ )	42.7	42.7	43.1	43.1	43.1	43.1	43.3	43.3	dBm
PAE @ P3dB ( $PAE_{3dB}$ )	67.1	65.9	65.1	64.4	63	62.7	60.3	60.4	%
Gain @ P3dB ( $G_{3dB}$ )	20.8	21.5	15.2	15.8	12.8	13.3	10.8	11.5	dB
Parallel Resistance <sup>(1)</sup> ( $R_p$ )	115	112	103	98.6	98.9	93.9	84.5	82.7	$\Omega$ ·mm
Parallel Capacitance <sup>(1)</sup> ( $C_p$ )	0.347	0.340	0.361	0.359	0.368	0.369	0.368	0.373	pF/mm
Load Reflection Coefficient <sup>(2)</sup> ( $\Gamma_L$ )	0.65 $\angle$ 19°	0.64 $\angle$ 19°	0.64 $\angle$ 40°	0.63 $\angle$ 40°	0.66 $\angle$ 48°	0.64 $\angle$ 52°	0.64 $\angle$ 63°	0.64 $\angle$ 64°	--

Notes:

1. Large signal equivalent output network (normalized).
2. Characteristic Impedance ( $Z_0$ ) = 5  $\Omega$ .

### Thermal and Reliability - CW <sup>(1)</sup>

Parameter	Test Conditions	Value	Units
Thermal Resistance, $\theta_{JC}$	$P_D = 3\text{ W}$ , $T_{\text{baseplate}} = 85^\circ\text{C}$	9.3	$^\circ\text{C/W}$
Channel Temperature, $T_{CH}$		113	$^\circ\text{C}$
Median Lifetime, $T_M$		2.5E11	Hrs
Thermal Resistance, $\theta_{JC}$	$P_D = 6\text{ W}$ , $T_{\text{baseplate}} = 85^\circ\text{C}$	10	$^\circ\text{C/W}$
Channel Temperature, $T_{CH}$		145	$^\circ\text{C}$
Median Lifetime, $T_M$		4.4E9	Hrs
Thermal Resistance, $\theta_{JC}$	$P_D = 9\text{ W}$ , $T_{\text{baseplate}} = 85^\circ\text{C}$	10.8	$^\circ\text{C/W}$
Channel Temperature, $T_{CH}$		182	$^\circ\text{C}$
Median Lifetime, $T_M$		8.6E7	Hrs
Thermal Resistance, $\theta_{JC}$	$P_D = 12\text{ W}$ , $T_{\text{baseplate}} = 85^\circ\text{C}$	11.8	$^\circ\text{C/W}$
Channel Temperature, $T_{CH}$		226	$^\circ\text{C}$
Median Lifetime, $T_M$		1.7E6	Hrs
Thermal Resistance, $\theta_{JC}$	$P_D = 15\text{ W}$ , $T_{\text{baseplate}} = 85^\circ\text{C}$	12.9	$^\circ\text{C/W}$
Channel Temperature, $T_{CH}$		278	$^\circ\text{C}$
Median Lifetime, $T_M$		3.6E4	Hrs

Notes:

1. Assumes eutectic attach using 1.5 mil thick 80/20 AuSn mounted to a 10 mm x 10 mm x 40 mil CuMo Carrier Plate.

### Thermal and Reliability - Pulsed <sup>(1)</sup>

Parameter	Test Conditions	Value	Units
Thermal Resistance, $\theta_{JC}$	$P_D = 17.5\text{ W}$ , $T_{\text{baseplate}} = 85^\circ\text{C}$ Pulse Width = 100 $\mu\text{s}$ Duty Cycle = 5%	4.7	$^\circ\text{C/W}$
Channel Temperature, $T_{CH}$		168	$^\circ\text{C}$
Median Lifetime, $T_M$		7.1E9	Hrs
Thermal Resistance, $\theta_{JC}$	$P_D = 17.5\text{ W}$ , $T_{\text{baseplate}} = 85^\circ\text{C}$ Pulse Width = 100 $\mu\text{s}$ Duty Cycle = 10%	5.0	$^\circ\text{C/W}$
Channel Temperature, $T_{CH}$		172	$^\circ\text{C}$
Median Lifetime, $T_M$		2.3E9	Hrs
Thermal Resistance, $\theta_{JC}$	$P_D = 17.5\text{ W}$ , $T_{\text{baseplate}} = 85^\circ\text{C}$ Pulse Width = 100 $\mu\text{s}$ Duty Cycle = 20%	5.3	$^\circ\text{C/W}$
Channel Temperature, $T_{CH}$		177	$^\circ\text{C}$
Median Lifetime, $T_M$		6.9E8	Hrs
Thermal Resistance, $\theta_{JC}$	$P_D = 17.5\text{ W}$ , $T_{\text{baseplate}} = 85^\circ\text{C}$ Pulse Width = 100 $\mu\text{s}$ Duty Cycle = 50%	6.6	$^\circ\text{C/W}$
Channel Temperature, $T_{CH}$		200	$^\circ\text{C}$
Median Lifetime, $T_M$		3.1E7	Hrs

Notes:

1. Assumes eutectic attach using 1.5 mil thick 80/20 AuSn mounted to a 10 mm x 10 mm x 40 mil CuMo Carrier Plate.

Median Lifetime

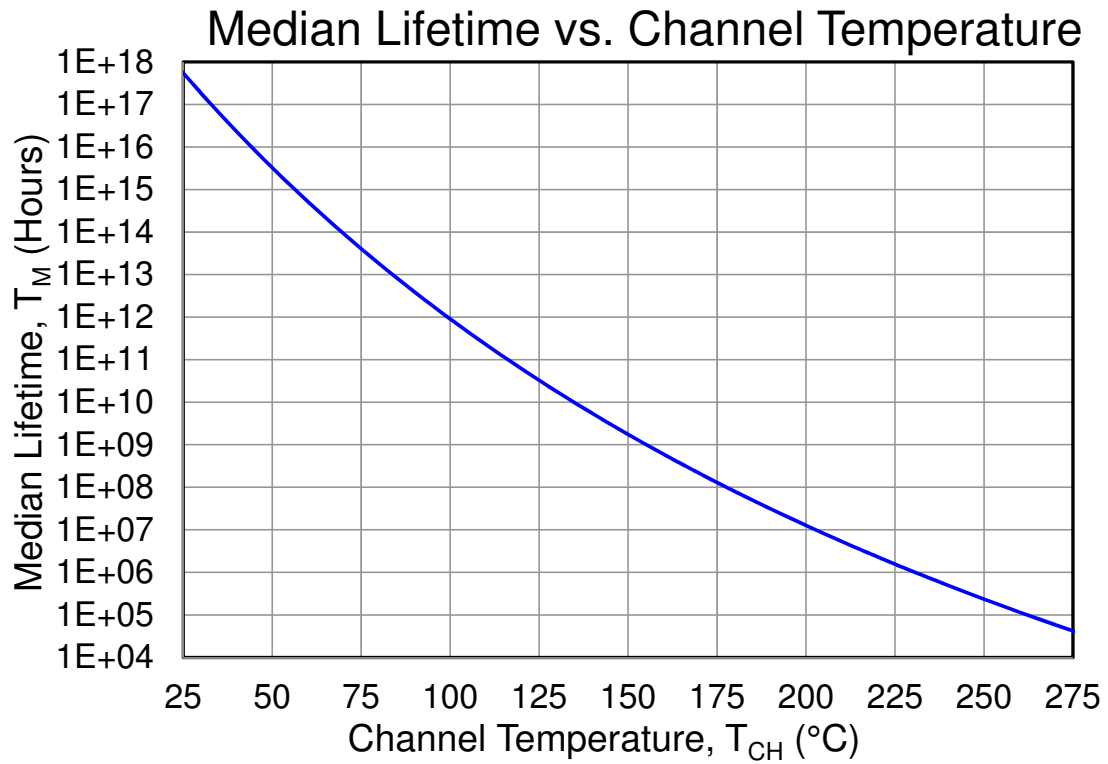

Maximum Channel Temperature - CW

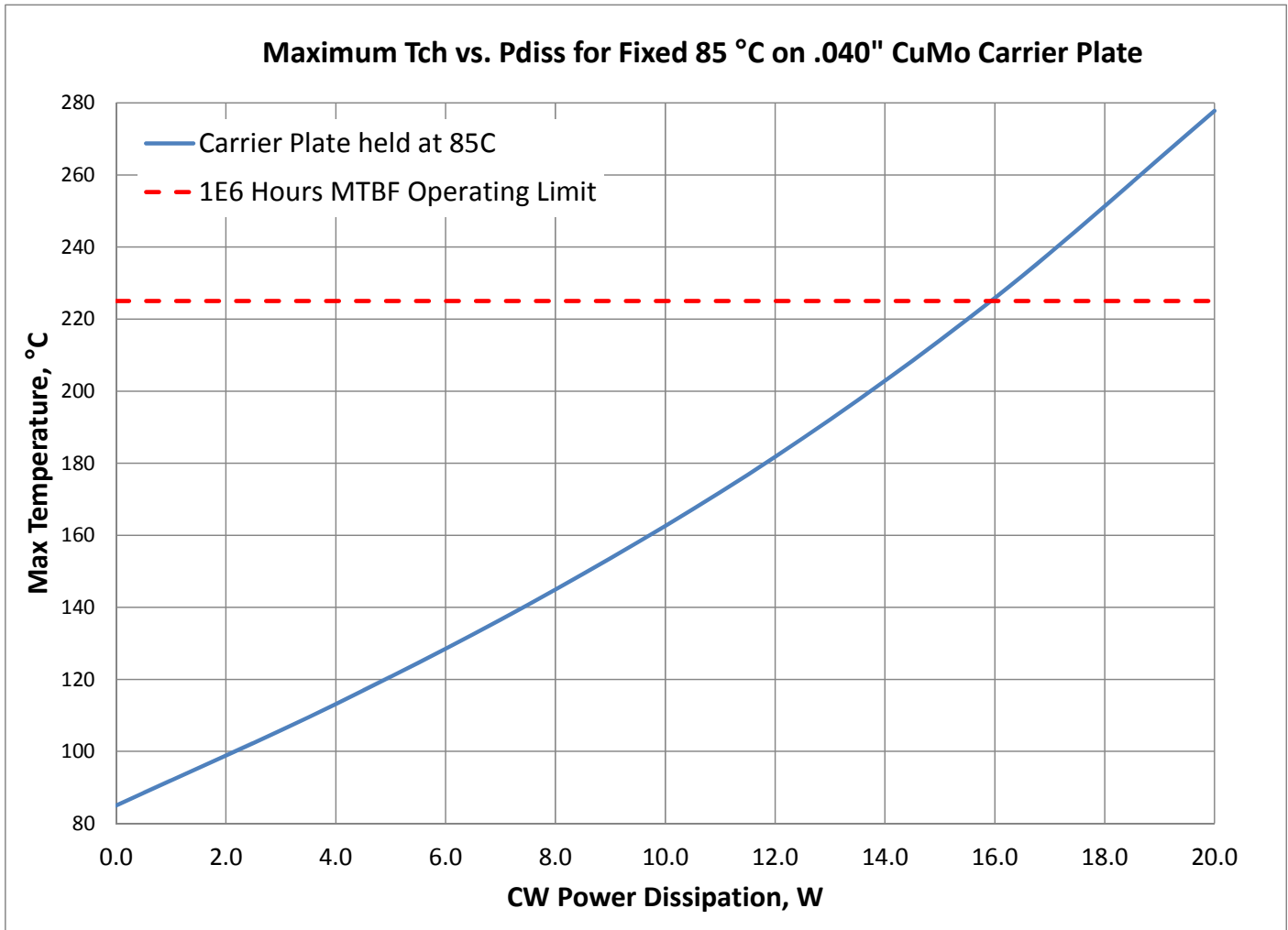

Peak Channel Temperature - Pulsed

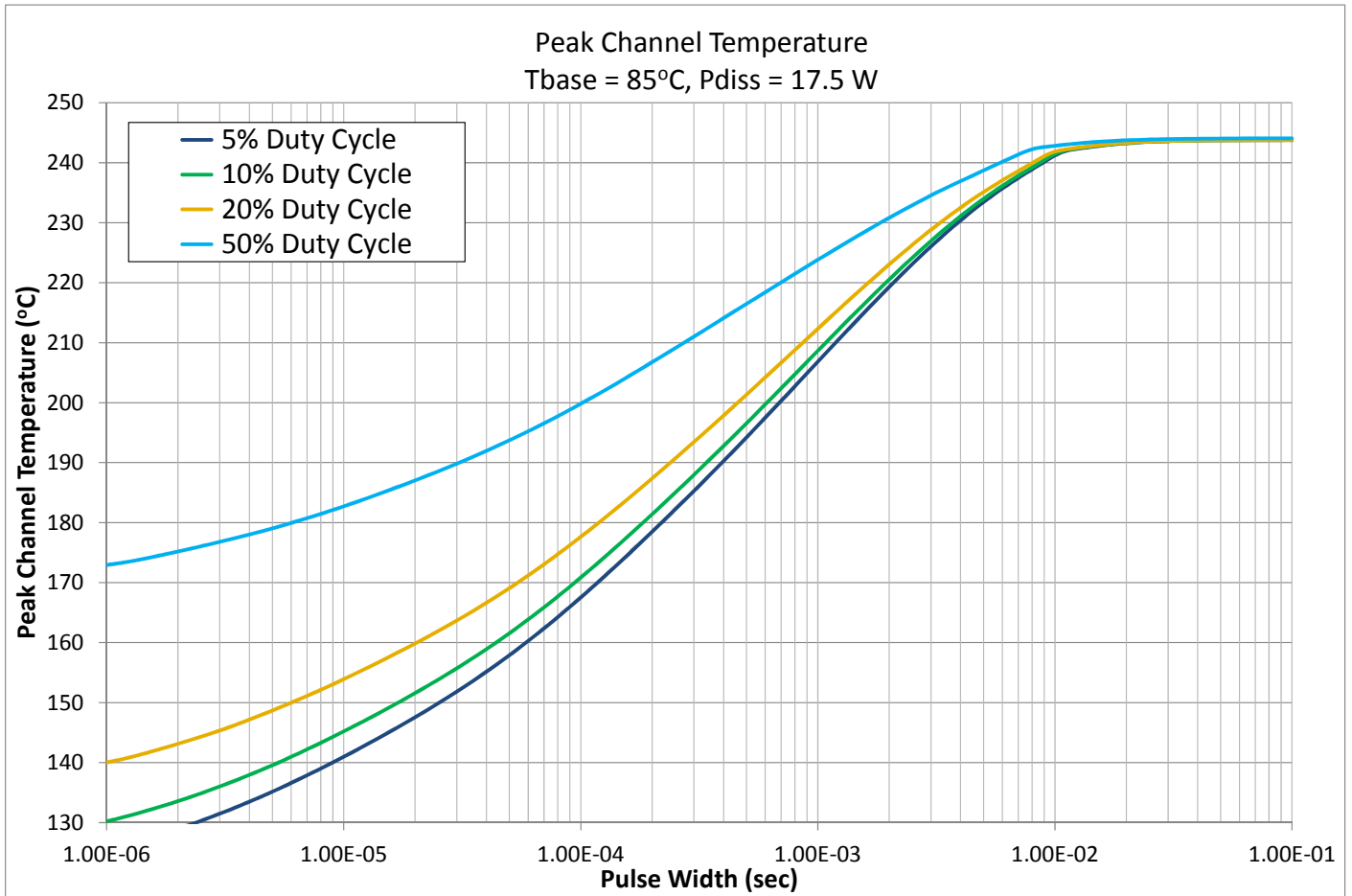

### Maximum Gain Performance

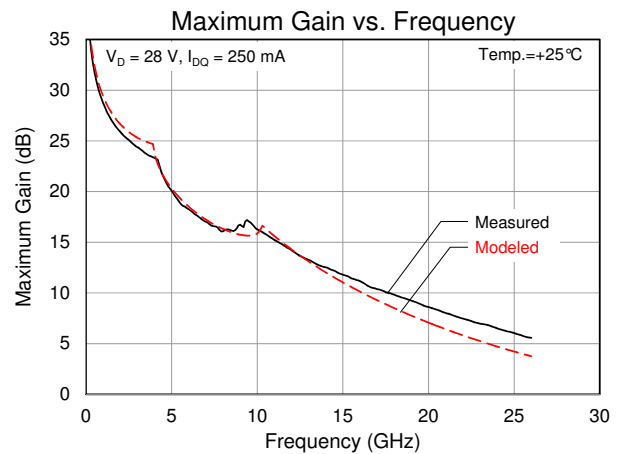
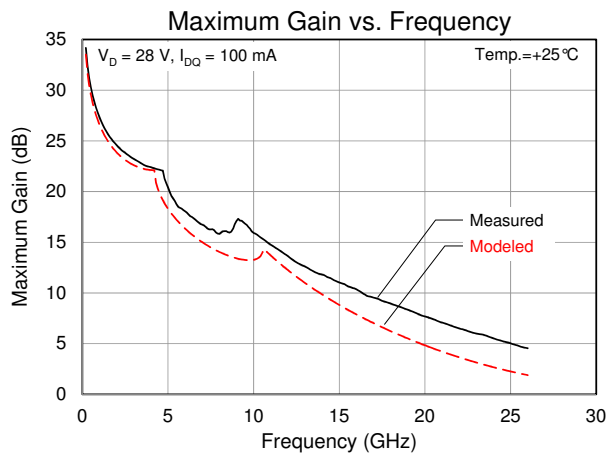
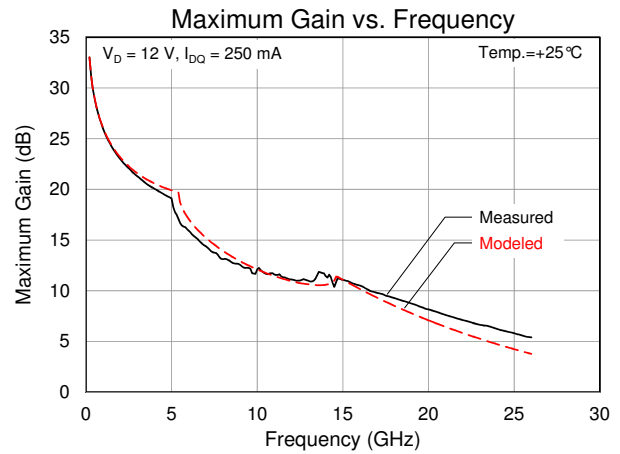
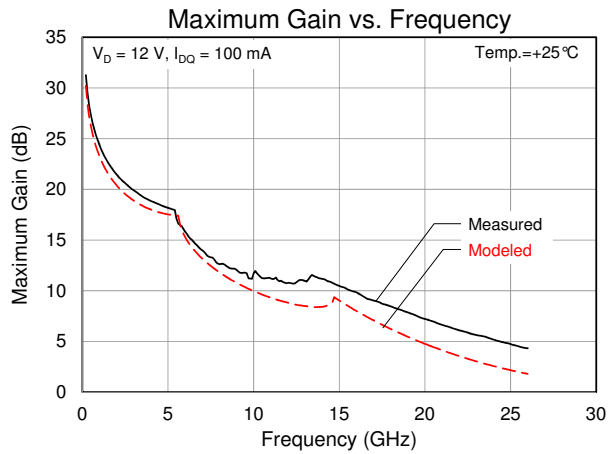

**Model Load Pull Contours – 3 GHz**

Simulated signal: 10% pulses  
 Vd = 28 V, Idq = 100 mA

**3GHz, Load-pull**

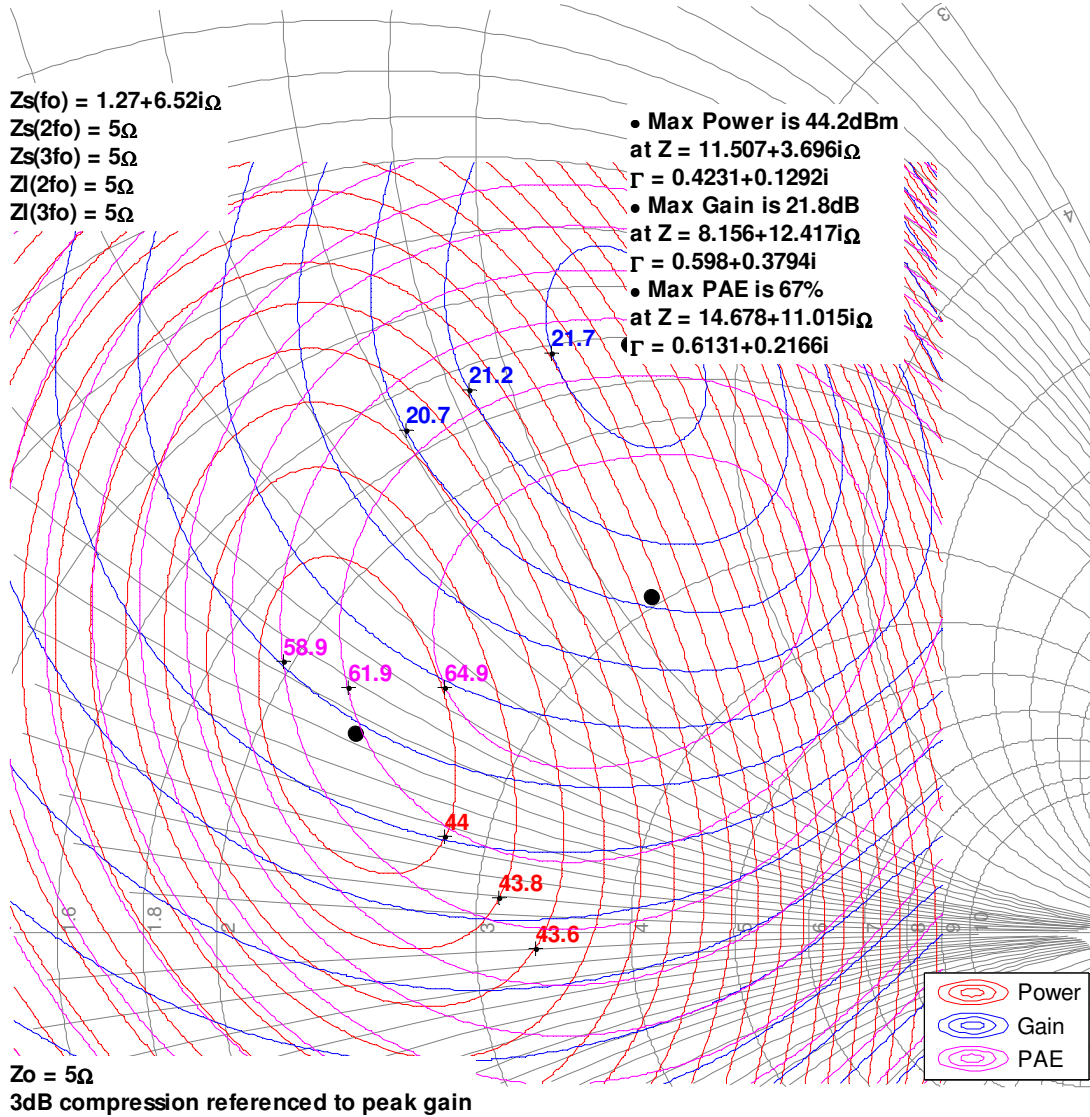



**Model Load Pull Contours – 6 GHz**

Simulated signal: 10% pulses  
 Vd = 28 V, Idq = 100 mA

6GHz, Load-pull

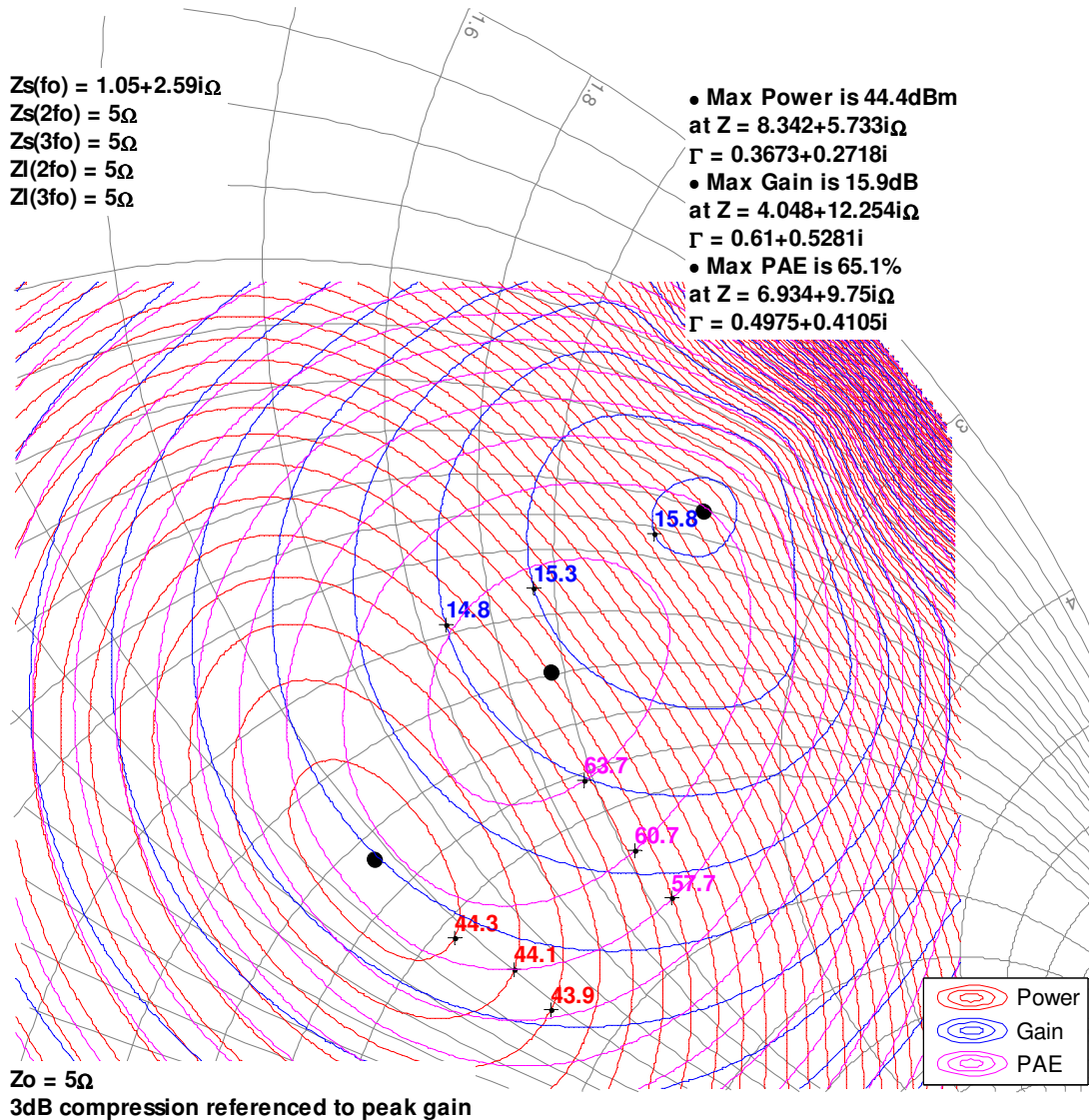

Model Load Pull Contours – 8 GHz

Simulated signal: 10% pulses  
Vd = 28 V, Idq = 100 mA

8GHz, Load-pull

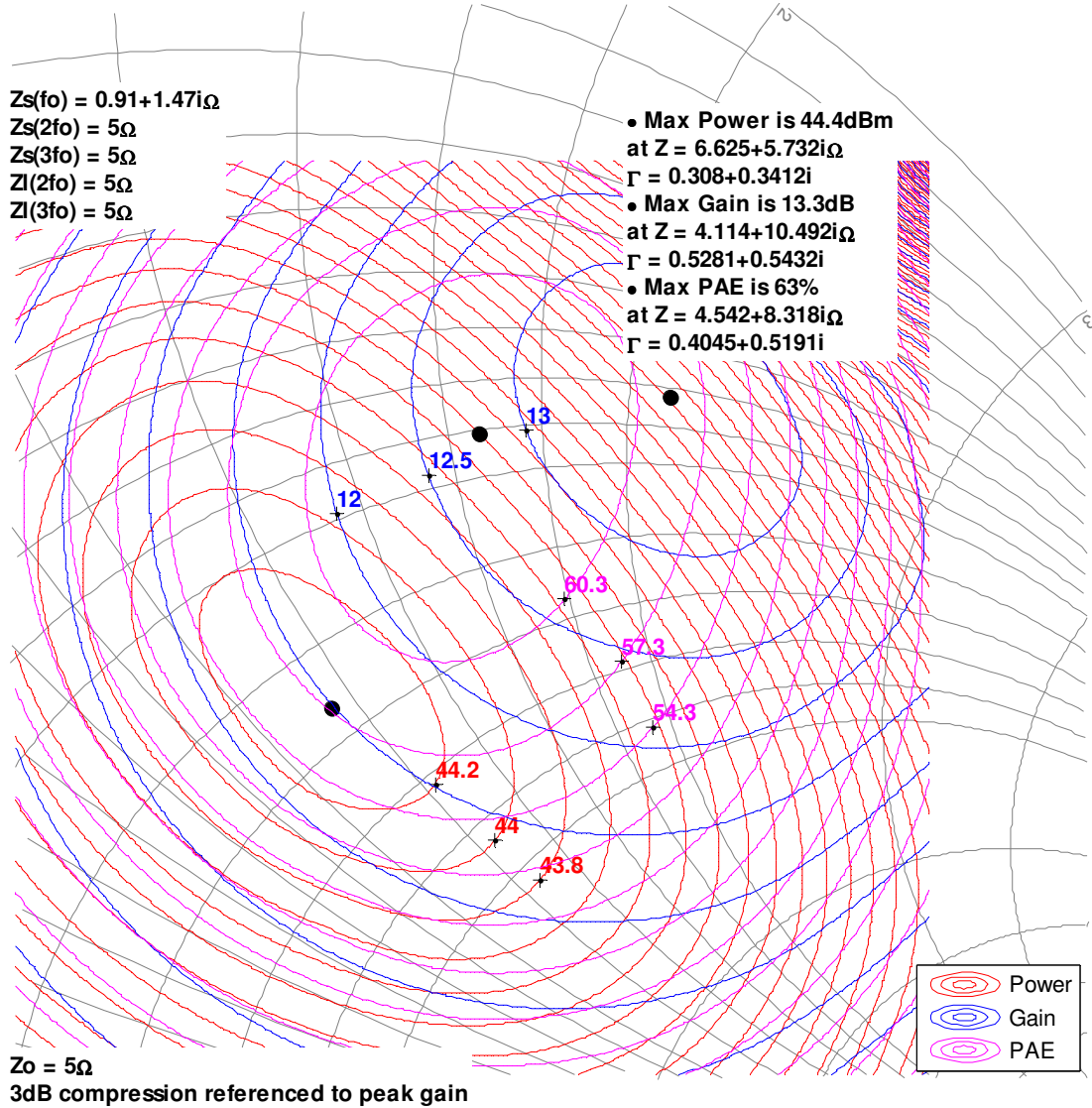

**Model Load Pull Contours – 10 GHz**

Simulated signal: 10% pulses  
 Vd = 28 V, Idq = 100 mA

10GHz, Load-pull

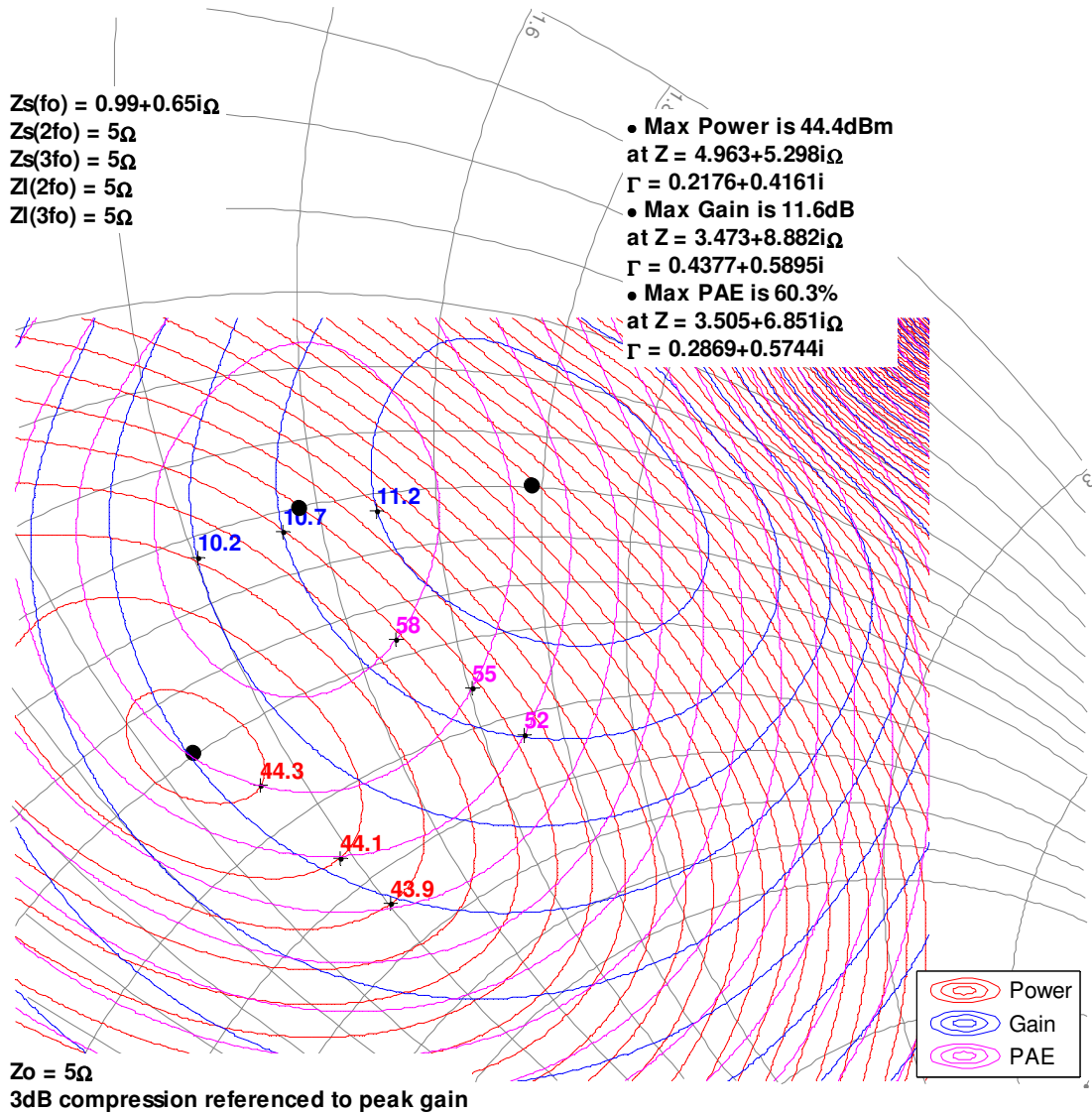

**Model Load Pull Contours – 3 GHz**

Simulated signal: 10% pulses  
 Vd = 28 V, Idq = 250 mA

**3GHz, Load-pull**

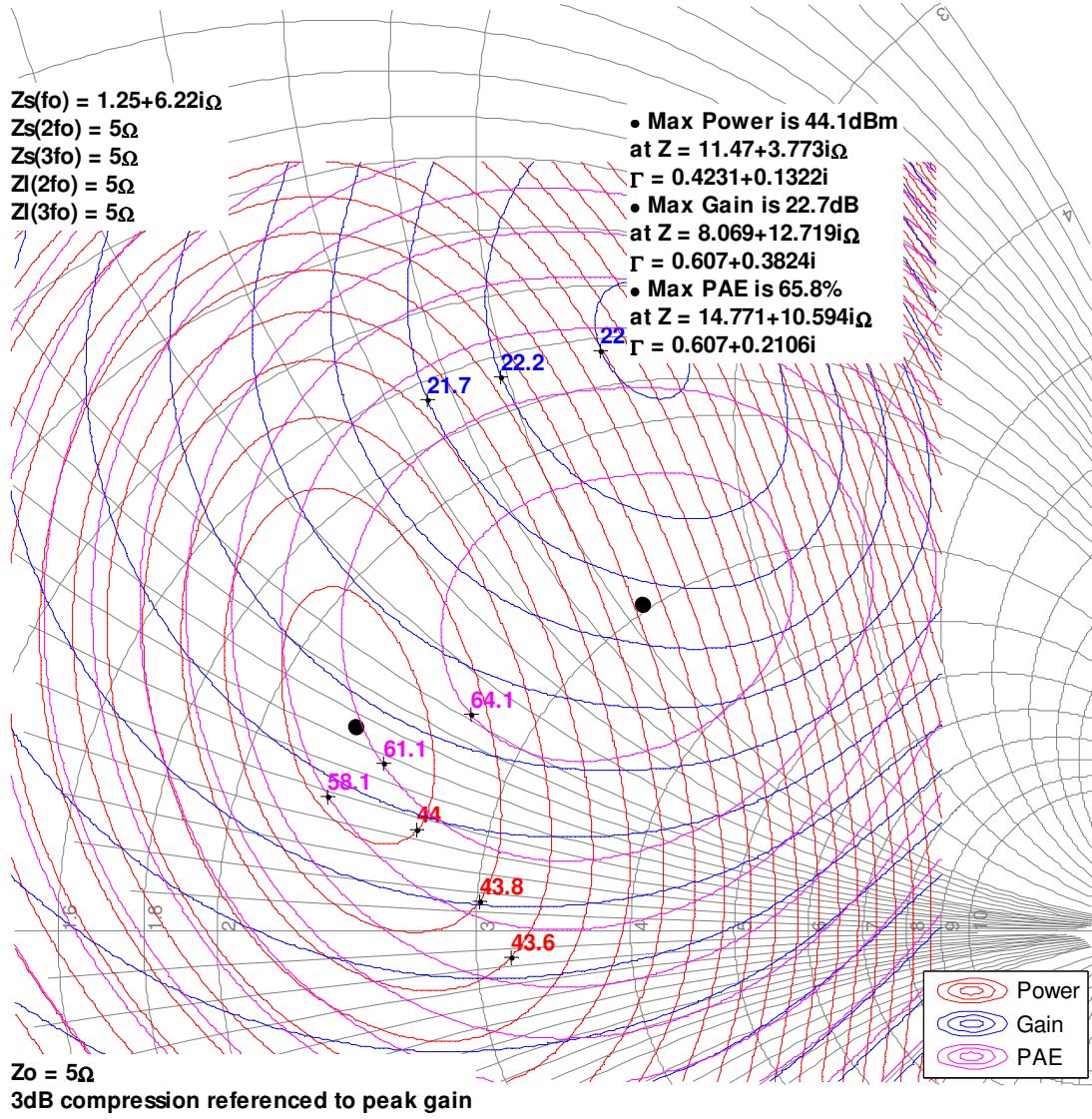

**Model Load Pull Contours – 6 GHz**

Simulated signal: 10% pulses  
 Vd = 28 V, Idq = 250 mA

6GHz, Load-pull

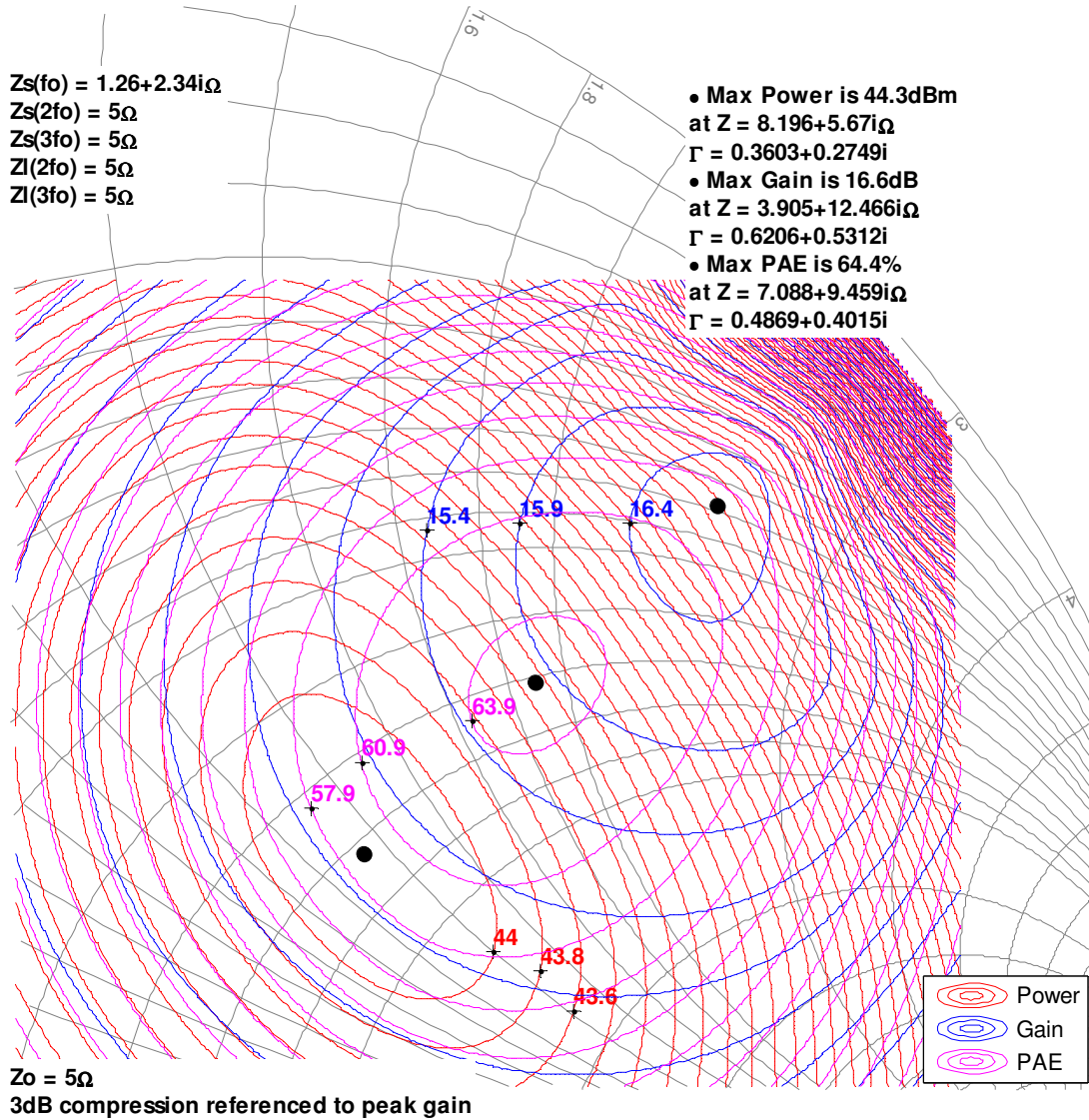



Model Load Pull Contours – 8 GHz

Simulated signal: 10% pulses  
Vd = 28 V, Idq = 250 mA

8GHz, Load-pull

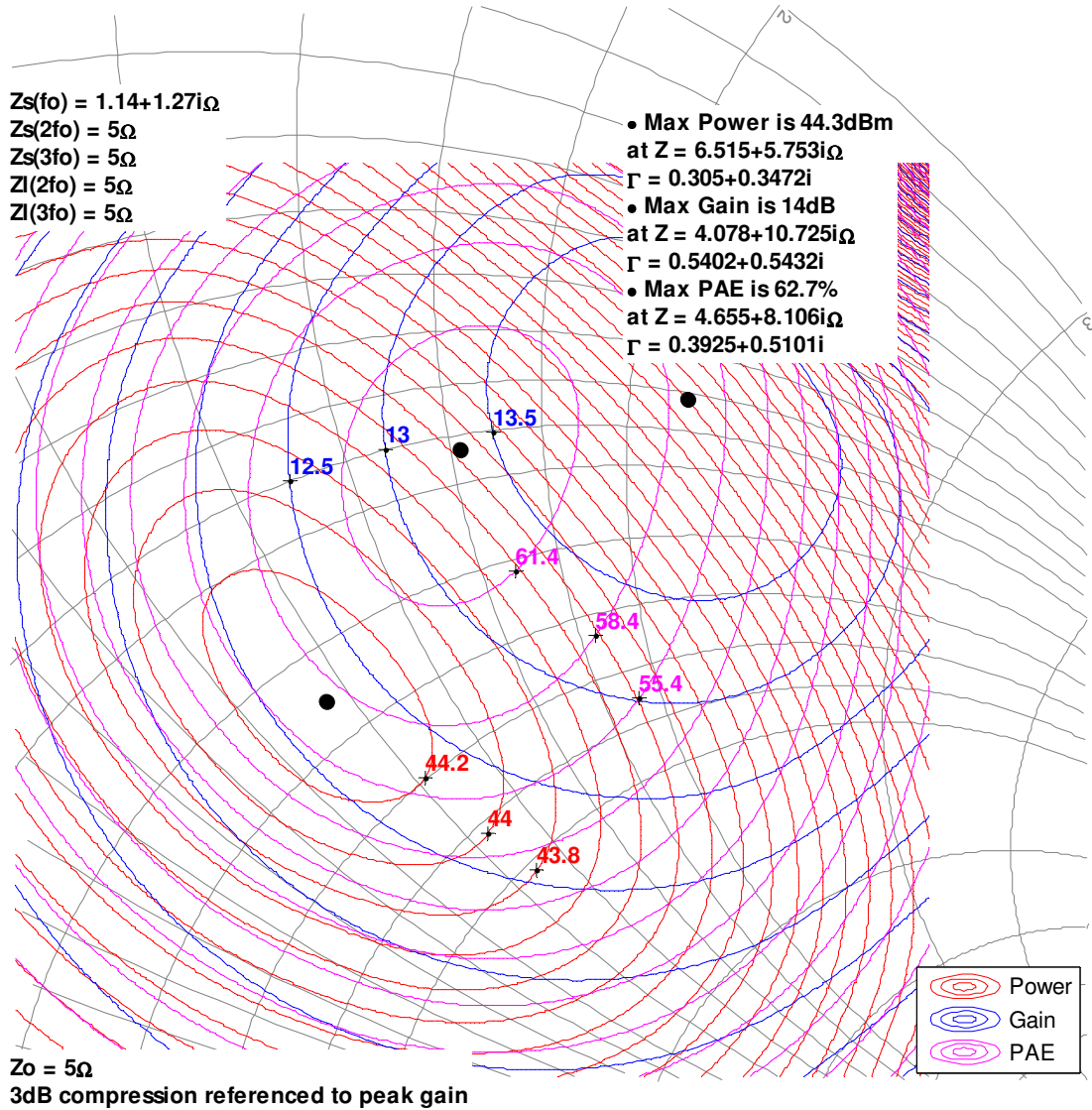

**Model Load Pull Contours – 10 GHz**

Simulated signal: 10% pulses  
 Vd = 28 V, Idq = 250 mA

10GHz, Load-pull

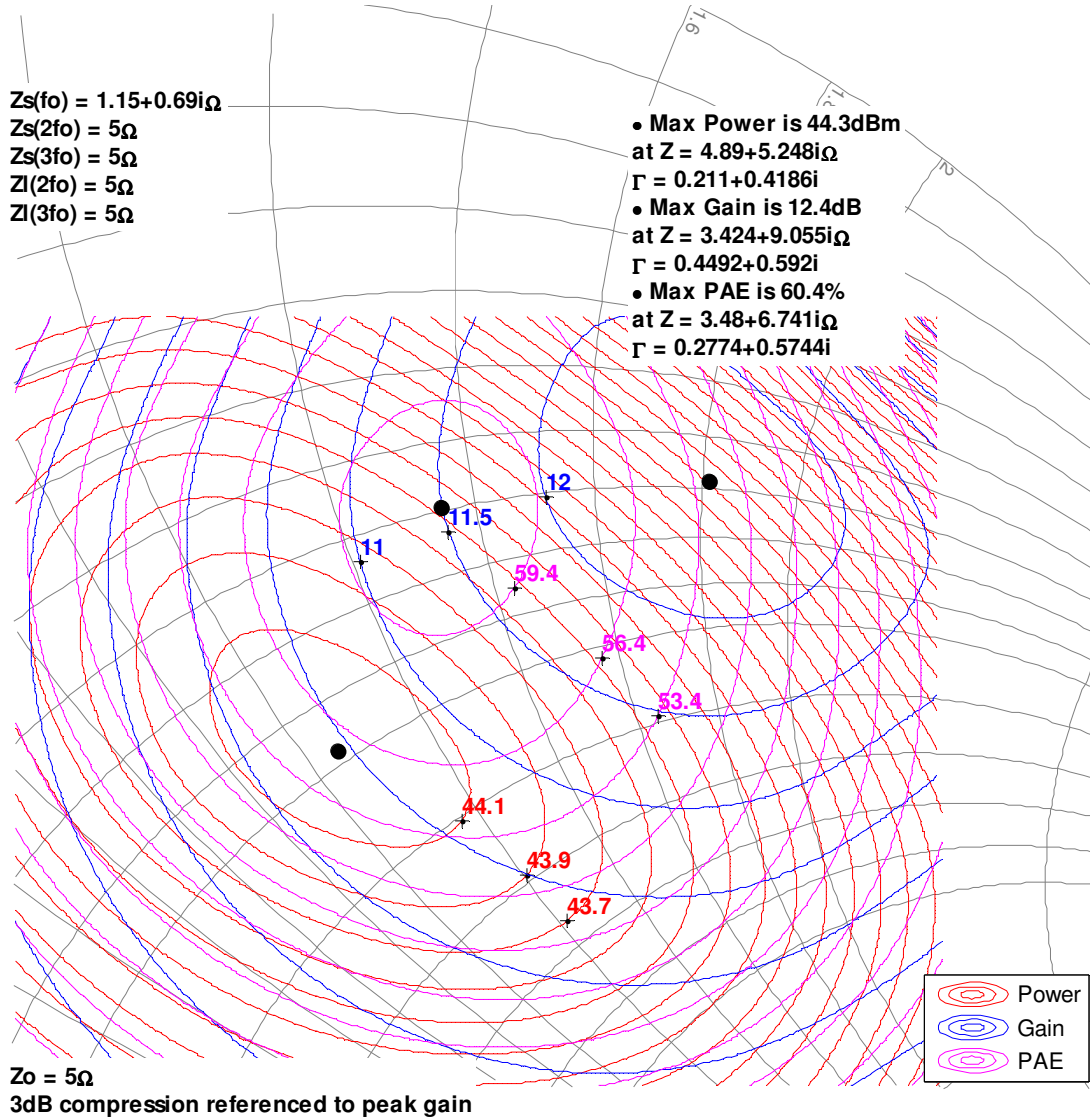

### Model Drive-up Data – 3 GHz

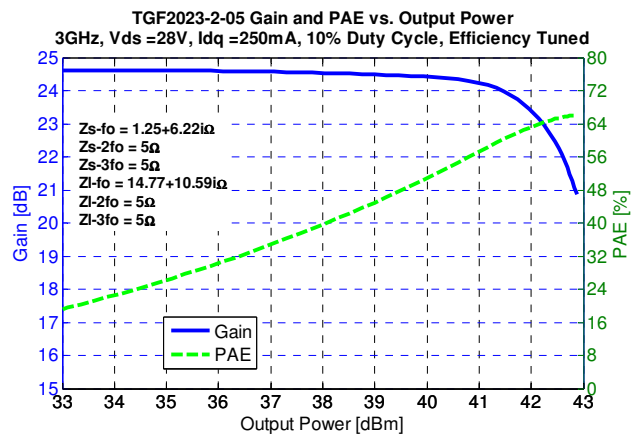
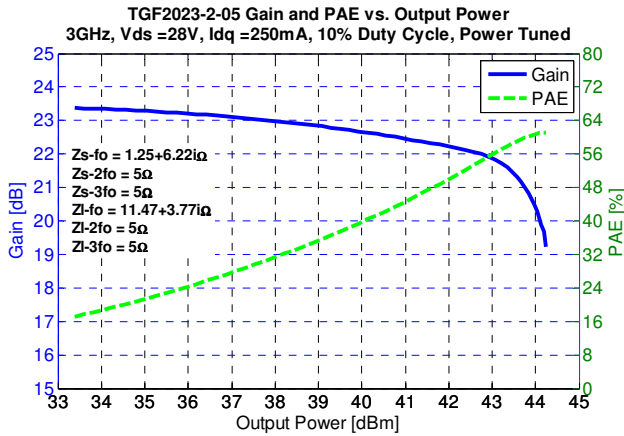
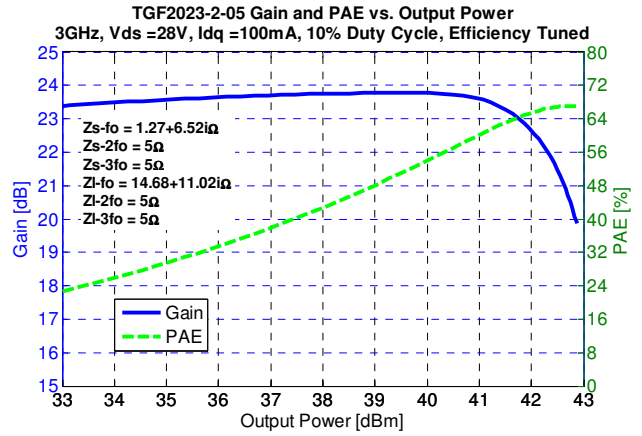
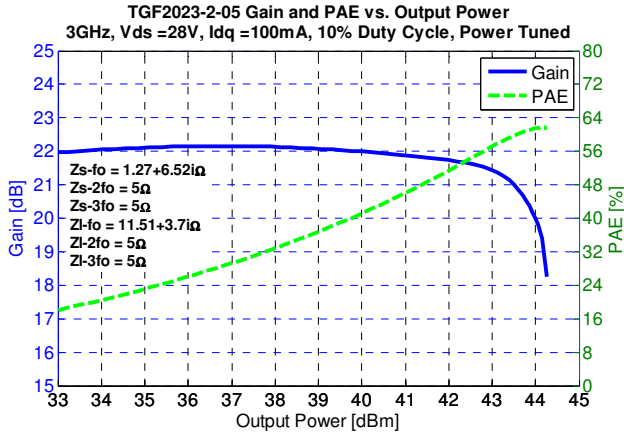



### Model Drive-up Data – 6 GHz

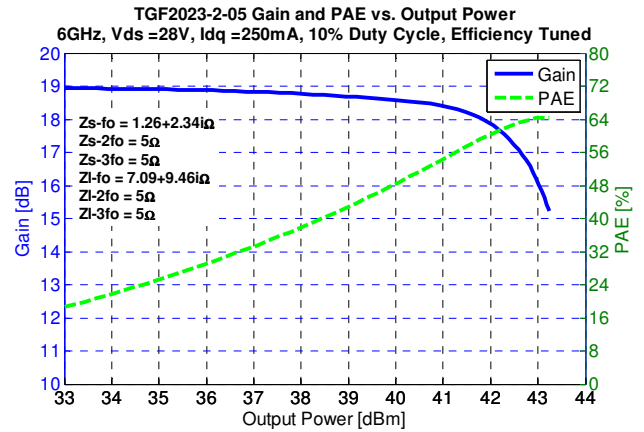
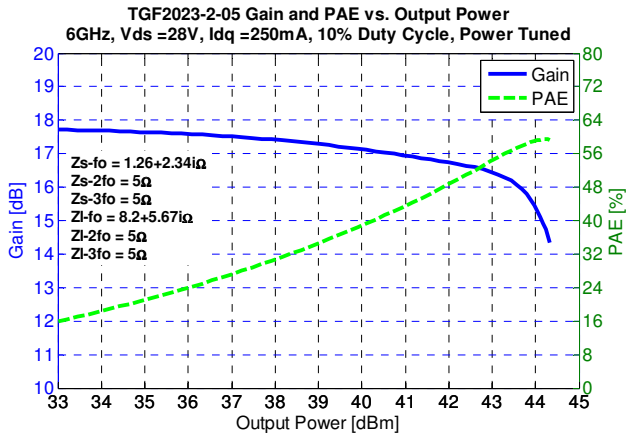
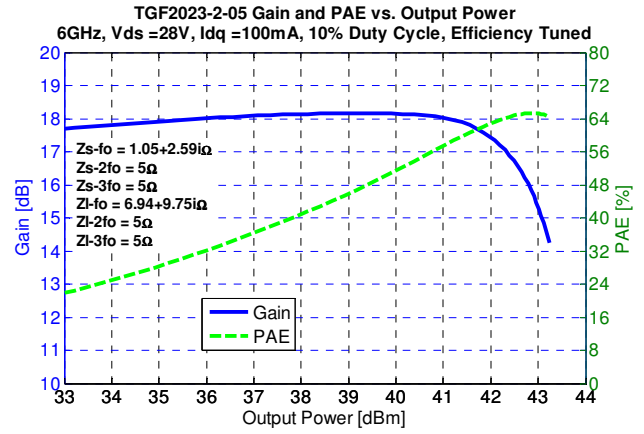
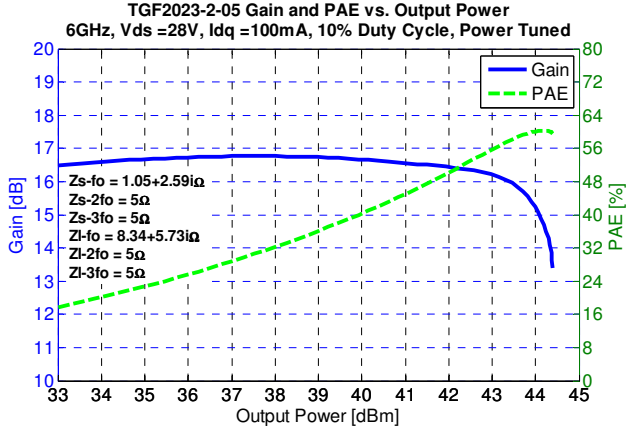

### Model Drive-up Data – 8 GHz

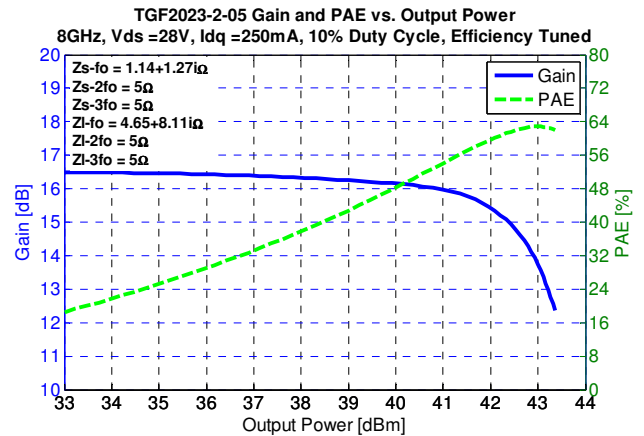
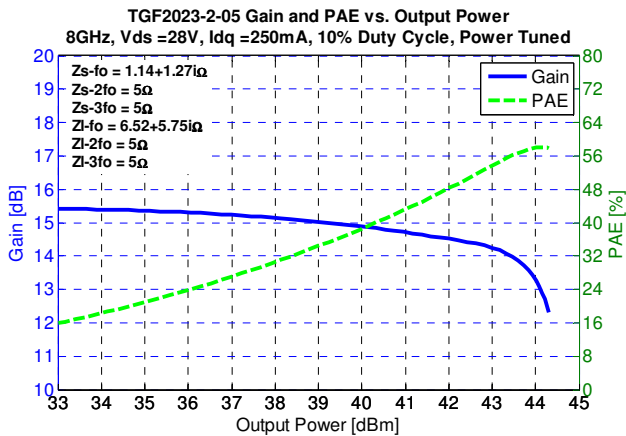
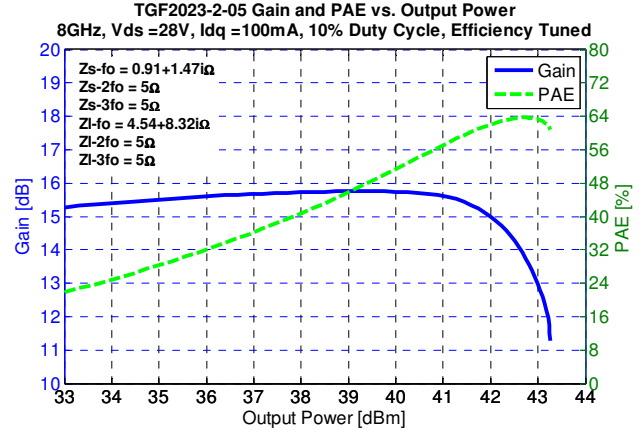
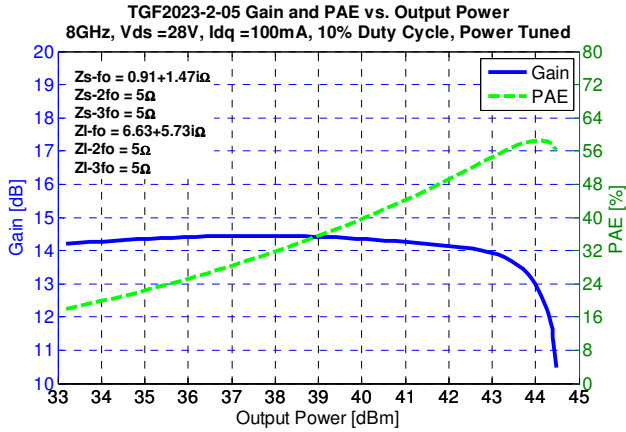

Model Drive-up Data – 10 GHz

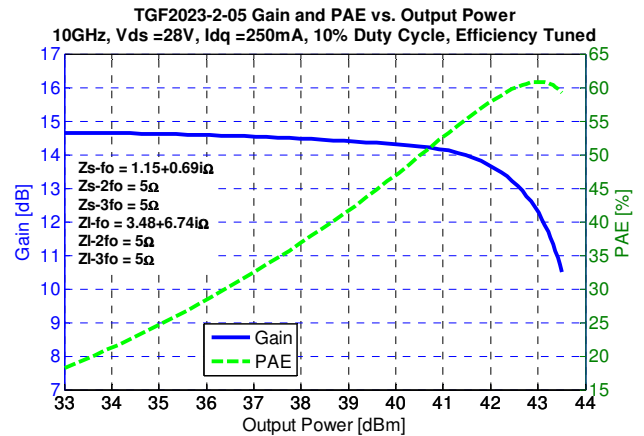
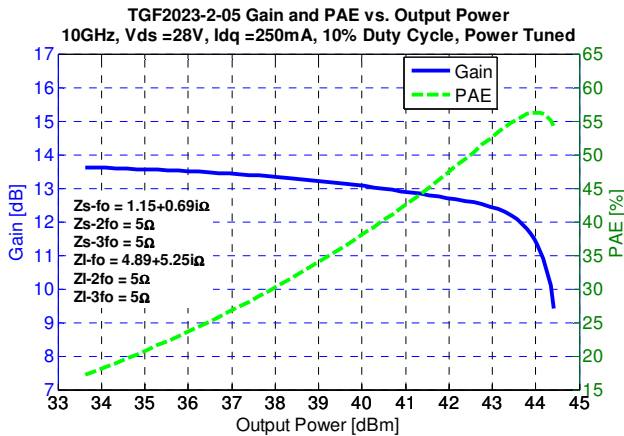
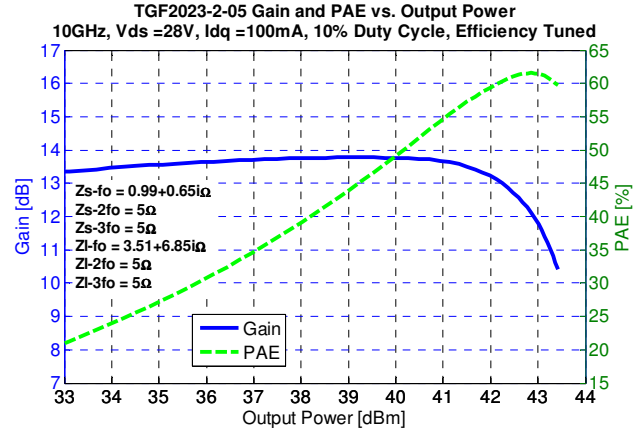
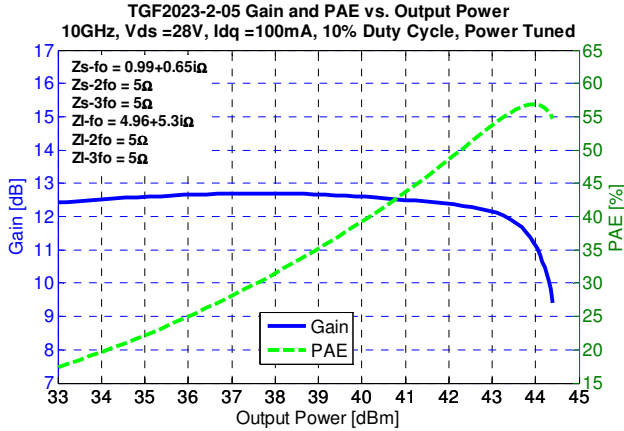

### Model

A non-linear model is available for download from Modelithics (at <http://www.modelithics.com/mvp/Qorvo&tab=3>) by approved Qorvo customers. The model is compatible with the industry's most popular design software including Agilent ADS and National Instruments/AWR applications. Once on the Modelithics web page, the user will need to register for a free license before being granted the download.

### Mechanical Drawing

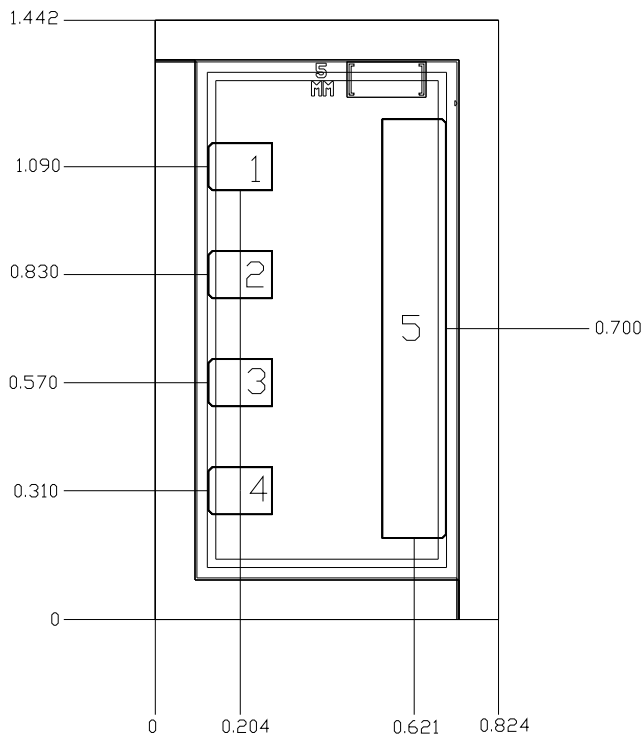

### Bond Pads

Pad No.	Description	Dimensions
1-4	Gate	0.154 x 0.115
5	Drain	0.154 x 1.01
Die Backside	Source / Ground	0.824 x 1.442

#### Notes:

1. Units: millimeters
2. Thickness: 0.100 mm
3. Die x,y size tolerance: +/- 0.050 mm

## Assembly Notes

Component placement and adhesive attachment assembly notes:

- Vacuum pencils and/or vacuum collets are the preferred method of pick up.
- Air bridges must be avoided during placement.
- The force impact is critical during auto placement.
- Organic attachment (i.e. epoxy) not recommended.

Reflow process assembly notes:

- Use AuSn (80/20) solder and limit exposure to temperatures above 300°C to 3-4 minutes, maximum.
- An alloy station or conveyor furnace with reducing atmosphere should be used.
- Do not use any kind of flux.
- Coefficient of thermal expansion matching is critical for long-term reliability.
- Devices must be stored in a dry nitrogen atmosphere.

Interconnect process assembly notes:

- Ball bonding is the preferred interconnect technique, except where noted on the assembly diagram.
- Force, time, and ultrasonics are critical bonding parameters.
- Aluminum wire should not be used.
- Devices with small pad sizes should be bonded with 0.0007-inch wire.

## Disclaimer

GaN/SiC devices are susceptible to damage from Electrostatic Discharge. Proper precautions should be observed during handling, assembly and test.

### Bias-up Procedure

1. Set  $V_G$  to -5 V.
2. Set  $I_D$  limit to 280 mA.
3. Set  $V_D$  to 28 V.
4. Adjust  $V_G$  more positive until quiescent  $I_D$  is 250 mA.
5. Set  $I_D$  limit to 2 A.
6. Apply RF signal.

### Bias-down Procedure

1. Turn off RF signal.
2. Turn off  $V_D$  and wait 1 second to allow drain capacitor dissipation.
3. Turn off  $V_G$ .

## Product Compliance Information

### ESD Sensitivity Ratings



Caution! ESD-Sensitive Device

GaN devices are susceptible to damage from Electrostatic Discharge. Proper precautions should be observed during handling, assembly and test.

Not HAST compliant.

### Solderability

Compatible with gold/tin (320°C maximum reflow temperature) soldering processes.

### RoHS Compliance

This part is compliant with EU 2002/95/EC RoHS directive (Restrictions on the Use of Certain Hazardous Substances in Electrical and Electronic Equipment).

This product also has the following attributes:

- Lead Free
- Halogen Free (Chlorine, Bromine)
- Antimony Free
- TBBP-A (C<sub>15</sub>H<sub>12</sub>Br<sub>4</sub>O<sub>2</sub>) Free
- PFOS Free
- SVHC Free

## Contact Information

For the latest specifications, additional product information, worldwide sales and distribution locations, and information about Qorvo:

**Web:** [www.qorvo.com](http://www.qorvo.com)      **Tel:** +1.972.994.8465  
**Email:** [info-sales@qorvo.com](mailto:info-sales@qorvo.com) **Fax:** +1.972.994.8504

For technical questions and application information:      **Email:** [info-products@qorvo.com](mailto:info-products@qorvo.com)

## Important Notice

The information contained herein is believed to be reliable. Qorvo makes no warranties regarding the information contained herein. Qorvo assumes no responsibility or liability whatsoever for any of the information contained herein. Qorvo assumes no responsibility or liability whatsoever for the use of the information contained herein. The information contained herein is provided "AS IS, WHERE IS" and with all faults, and the entire risk associated with such information is entirely with the user. All information contained herein is subject to change without notice. Customers should obtain and verify the latest relevant information before placing orders for Qorvo products. The information contained herein or any use of such information does not grant, explicitly or implicitly, to any party any patent rights, licenses, or any other intellectual property rights, whether with regard to such information itself or anything described by such information.

Qorvo products are not warranted or authorized for use as critical components in medical, life-saving, or life-sustaining applications, or other applications where a failure would reasonably be expected to cause severe personal injury or death.

Компания «Life Electronics» занимается поставками электронных компонентов импортного и отечественного производства от производителей и со складов крупных дистрибьюторов Европы, Америки и Азии.

С конца 2013 года компания активно расширяет линейку поставок компонентов по направлению коаксиальный кабель, кварцевые генераторы и конденсаторы (керамические, пленочные, электролитические), за счёт заключения дистрибьюторских договоров

Мы предлагаем:

- Конкурентоспособные цены и скидки постоянным клиентам.
- Специальные условия для постоянных клиентов.
- Подбор аналогов.
- Поставку компонентов в любых объемах, удовлетворяющих вашим потребностям.
- Приемлемые сроки поставки, возможна ускоренная поставка.
- Доставку товара в любую точку России и стран СНГ.
- Комплексную поставку.
- Работу по проектам и поставку образцов.
- Формирование склада под заказчика.
- Сертификаты соответствия на поставляемую продукцию (по желанию клиента).
- Тестирование поставляемой продукции.
- Поставку компонентов, требующих военную и космическую приемку.
- Входной контроль качества.
- Наличие сертификата ISO.

В составе нашей компании организован Конструкторский отдел, призванный помогать разработчикам, и инженерам.

Конструкторский отдел помогает осуществить:

- Регистрацию проекта у производителя компонентов.
- Техническую поддержку проекта.
- Защиту от снятия компонента с производства.
- Оценку стоимости проекта по компонентам.
- Изготовление тестовой платы монтаж и пусконаладочные работы.



Тел: +7 (812) 336 43 04 (многоканальный)

Email: [org@lifeelectronics.ru](mailto:org@lifeelectronics.ru)