

NCV2393, TS393

Micropower Dual CMOS Voltage Comparator

The NCV2393 and TS393 are micropower CMOS dual voltage comparators. They feature extremely low consumption of 6 μA typical per comparator and operate over a wide temperature range of $T_A = -40$ to 125°C . The NCV2393 and TS393 are available in an SOIC-8 package.

Features

- Extremely Low Supply Current: 6 μA Typical Per Channel
- Wide Supply Range: 2.7 to 16 V
- Extremely Low Input Bias Current: 1 pA Typical
- Extremely Low Input Offset Current: 1 pA Typical
- Input Common Mode Range Includes V_{SS}
- High Input Impedance: $10^{12} \Omega$
- Pin-to-Pin Compatibility with Dual Bipolar LM393
- NCV Prefix for Automotive and Other Applications Requiring Unique Site and Control Change Requirements; AEC-Q100 Qualified and PPAP Capable
- These Devices are Pb-Free, Halogen Free/BFR Free and are RoHS Compliant



ON Semiconductor[®]

<http://onsemi.com>

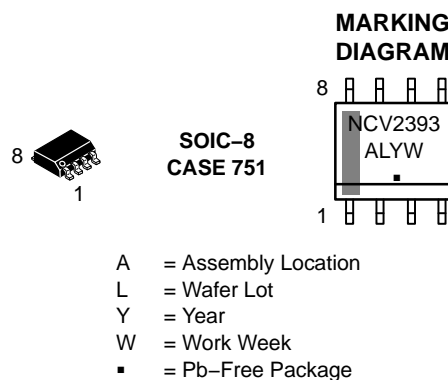

PIN CONNECTIONS

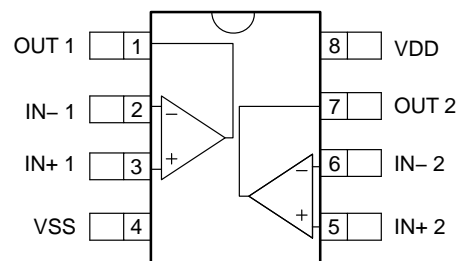

ORDERING INFORMATION

Device	Package	Shipping [†]
NCV2393DR2G	SOIC-8 (Pb-Free)	2500 / Tape & Reel
TS393DR2G	SOIC-8 (Pb-Free)	2500 / Tape & Reel

[†]For information on tape and reel specifications, including part orientation and tape sizes, please refer to our Tape and Reel Packaging Specifications Brochure, BRD8011/D.

NCV2393, TS393

PIN DESCRIPTION

Pin	Name	Type	Description
1	OUT 1	Output	Output of comparator 1. The open-drain output requires an external pull-up resistor.
2	IN- 1	Input	Inverting input of comparator 1
3	IN+ 1	Input	Non-inverting input of comparator 1
4	VSS	Power	Negative supply
5	IN+ 2	Input	Non-inverting input of comparator 2
6	IN- 2	Input	Inverting input of comparator 2
7	OUT 2	Output	Output of comparator 2. The open-drain output requires an external pull-up resistor.
8	VDD	Power	Positive supply

ABSOLUTE MAXIMUM RATINGS (Note 1)

Over operating free-air temperature, unless otherwise stated

Parameter	Limit	Unit
Supply Voltage, V_S ($V_{DD}-V_{SS}$)	18	V

INPUT AND OUTPUT PINS

Input Voltage (Note 2)	18	V
Input Differential Voltage, V_{ID} (Note 3)	± 18	V
Input Current (through ESD protection diodes)	50	mA
Output Voltage	18	V
Output Current	20	mA

TEMPERATURE

Storage Temperature	-65 to +150	°C
Junction Temperature	150	°C

ESD RATINGS

Human Body Model	1500	V
Machine Model	50	V

LATCH-UP RATINGS

Latch-up Current	100	mA
------------------	-----	----

Stresses exceeding those listed in the Maximum Ratings table may damage the device. If any of these limits are exceeded, device functionality should not be assumed, damage may occur and reliability may be affected.

- Stresses beyond the absolute maximum ratings can lead to reduced reliability and damage.
- Excursions of input voltages may exceed the power supply level. As long as the common mode voltage [$V_{CM} = (V_{IN+} + V_{IN-})/2$] remains within the specified range, the comparator will provide a stable output state. However, the maximum current through the ESD diodes of the input stage must strictly be observed.
- Input differential voltage is the non-inverting input terminal with respect to the inverting input terminal. To prevent damage to the gates, each comparator includes back-to-back zener diodes between input terminals. When differential voltage exceeds 6.2 V, the diodes turn on. Input resistors of 1 k Ω have been integrated to limit the current in this event.
- This device series incorporates ESD protection and is tested by the following methods:
ESD Human Body Model tested per AEC-Q100-002 (JEDEC standard: JESD22-A114)
ESD Machine Model tested per AEC-Q100-003 (JEDEC standard: JESD22-A115)
Latch-up Current tested per JEDEC standard: JESD78.

THERMAL INFORMATION (Note 5)

Thermal Metric	Symbol	Value	Unit
Junction-to-Ambient (Note 6)	θ_{JA}	190	°C/W
Junction-to-Case Top	Ψ_{JT}	107	°C/W

- Short-circuits can cause excessive heating and destructive dissipation. Values are typical.
- Multilayer board, 1 oz. copper, 400 mm² copper area, both junctions heated equally

NCV2393, TS393

OPERATING CONDITIONS

Parameter	Symbol	Limit	Unit
Supply Voltage ($V_{DD} - V_{SS}$)	V_S	+2.7 to +16	V
Operating Free Air Temperature Range	T_A	-40 to +125	°C

Functional operation above the stresses listed in the Recommended Operating Ranges is not implied. Extended exposure to stresses beyond the Recommended Operating Ranges limits may affect device reliability.

ELECTRICAL CHARACTERISTICS: $V_S = +3\text{ V}$

(**Boldface** limits apply over the specified temperature range, $T_A = -40^\circ\text{C}$ to $+125^\circ\text{C}$.)

Parameter	Symbol	Conditions	Min	Typ	Max	Unit
-----------	--------	------------	-----	-----	-----	------

INPUT CHARACTERISTICS

Offset Voltage	V_{OS}	$V_{CM} = \text{mid-supply}$		1.4		mV
Input Bias Current (Note 7)	I_{IB}	$V_{CM} = \text{mid-supply}$		1		pA
					600	pA
Input Offset Current (Note 7)	I_{OS}	$V_{CM} = \text{mid-supply}$		1		pA
					300	pA
Input Common Mode Range	V_{CM}		V_{SS}		$V_{DD} - 1.5$	V
			V_{SS}		$V_{DD} - 2$	V
Common Mode Rejection Ratio	CMRR	$V_{CM} = V_{SS}$ to $V_{CM} = V_{DD} - 1.5\text{ V}$		70		dB

OUTPUT CHARACTERISTICS

Output Voltage Low	V_{OL}	$V_{ID} = -1\text{ V}$, $I_{OL} = +6\text{ mA}$		$V_{SS} + 300$	$V_{SS} + 450$	mV
					$V_{SS} + 700$	mV
Output Current High	I_{OH}	$V_{ID} = +1\text{ V}$, $V_{OH} = +3\text{ V}$		2	40	nA
					1000	nA

DYNAMIC PERFORMANCE

Propagation Delay Low to High	t_{PLH}	$V_{CM} = \text{mid-supply}$, $f = 10\text{ kHz}$, $R_{PU} = 5.1\text{ k}\Omega$, $C_L = 50\text{ pF}$	5 mV overdrive		2.1		μs
			TTL input		0.6		μs
Propagation Delay High to Low	t_{PHL}	$V_{CM} = \text{mid-supply}$, $f = 10\text{ kHz}$, $R_{PU} = 5.1\text{ k}\Omega$, $C_L = 50\text{ pF}$	5 mV overdrive		3.9		μs
			TTL input		0.2		μs

POWER SUPPLY

Power Supply Rejection Ratio	PSRR	$V_S = +3\text{ V}$ to $+5\text{ V}$		70		dB
Quiescent Current	I_{DD}	Per channel, no load, output = LOW		6	15	μA
					20	μA

Product parametric performance is indicated in the Electrical Characteristics for the listed test conditions, unless otherwise noted. Product performance may not be indicated by the Electrical Characteristics if operated under different conditions.

7. Guaranteed by characterization and/or design.

NCV2393, TS393

ELECTRICAL CHARACTERISTICS: $V_S = +5\text{ V}$, unless otherwise noted
(Boldface limits apply over the specified temperature range, $T_A = -40^\circ\text{C}$ to $+125^\circ\text{C}$.)

Parameter	Symbol	Conditions	Min	Typ	Max	Unit
-----------	--------	------------	-----	-----	-----	------

INPUT CHARACTERISTICS

Offset Voltage	V_{OS}	$V_{CM} = \text{mid-supply V}$, $V_S = 5\text{ V to }10\text{ V}$		1.4		mV
Input Bias Current (Note 8)	I_{IB}	$V_{CM} = \text{mid-supply}$		1		pA
					600	pA
Input Offset Current (Note 8)	I_{OS}	$V_{CM} = \text{mid-supply}$		1		pA
					300	pA
Input Common Mode Range	V_{CM}		V_{SS}		$V_{DD} - 1.5$	V
			V_{SS}		$V_{DD} - 2$	V
Common Mode Rejection Ratio	CMRR	$V_{CM} = V_{SS}$ to $V_{CM} = V_{DD} - 1.5\text{ V}$		71		dB

OUTPUT CHARACTERISTICS

Output Voltage Low	V_{OL}	$V_{ID} = -1\text{ V}$, $I_{OL} = +6\text{ mA}$		$V_{SS} + 260$	$V_{SS} + 350$	mV
					$V_{SS} + 550$	mV
Output Current High	I_{OH}	$V_{ID} = +1\text{ V}$, $V_{OH} = +5\text{ V}$		2	40	nA
					1000	nA

DYNAMIC PERFORMANCE

Fall Time	t_{FALL}	50 mV overdrive, $f = 10\text{ kHz}$, $R_{PU} = 5.1\text{ k}\Omega$, $C_L = 50\text{ pF}$			25		ns
Propagation Delay Low to High	t_{PLH}	$V_{CM} = \text{mid-supply}$, $f = 10\text{ kHz}$, $R_{PU} = 5.1\text{ k}\Omega$, $C_L = 50\text{ pF}$	5 mV overdrive		2.1		μs
			10 mV overdrive		1.2		μs
			20 mV overdrive		0.8		μs
			40 mV overdrive		0.5		μs
			TTL input		0.6		μs
Propagation Delay High to Low	t_{PHL}	$V_{CM} = \text{mid-supply}$, $f = 10\text{ kHz}$, $R_{PU} = 5.1\text{ k}\Omega$, $C_L = 50\text{ pF}$	5 mV overdrive		5.8		μs
			10 mV overdrive		3.2		μs
			20 mV overdrive		1.7		μs
			40 mV overdrive		1.0		μs
			TTL input		0.3		μs

POWER SUPPLY

Power Supply Rejection Ratio	PSRR	$V_S = +5\text{ V to }+10\text{ V}$		80		dB
Quiescent Current	I_{DD}	Per channel, no load, output = LOW		6	15	μA
					20	μA

Product parametric performance is indicated in the Electrical Characteristics for the listed test conditions, unless otherwise noted. Product performance may not be indicated by the Electrical Characteristics if operated under different conditions.

8. Guaranteed by characterization and/or design

NCV2393, TS393

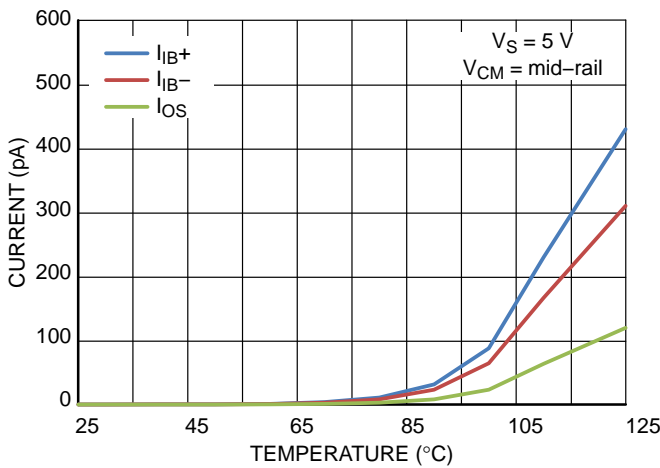

Figure 1. I_{IB} and I_{OS} vs. Temperature

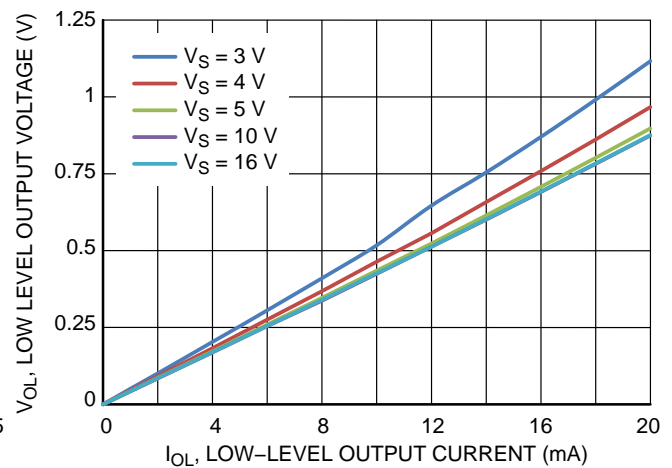

Figure 2. V_{OL} vs. I_{OL}

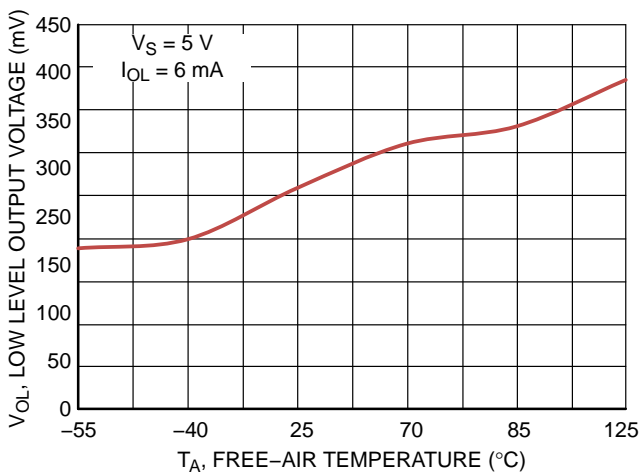

Figure 3. V_{OL} vs. Temperature

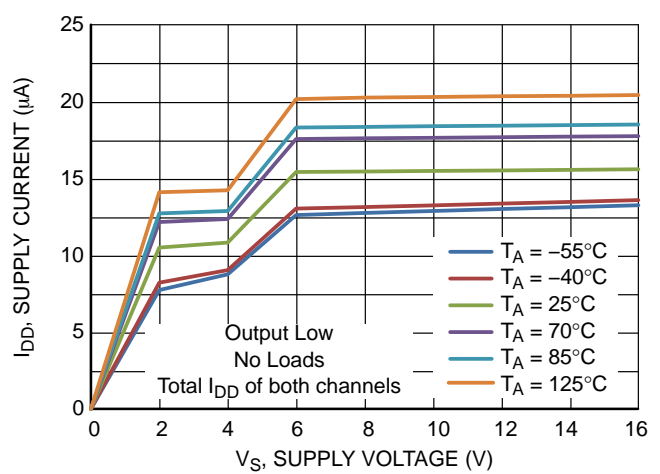

Figure 4. I_{DD} vs. V_S

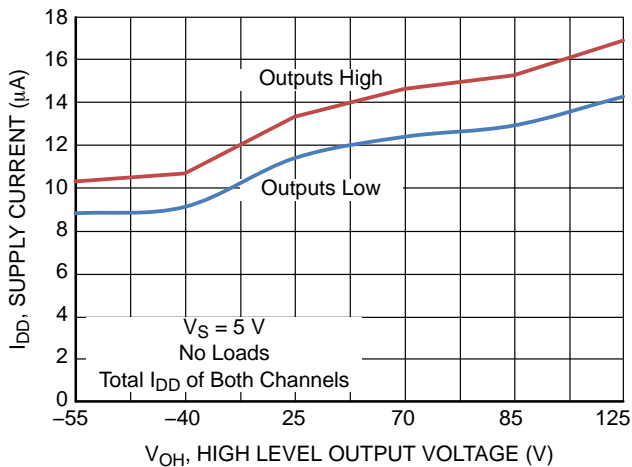

Figure 5. I_{DD} vs. Temperature

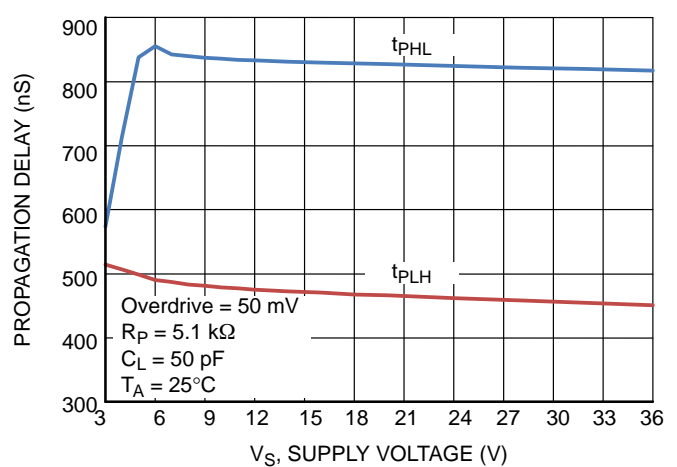

Figure 6. Propagation Delay vs. V_S

NCV2393, TS393

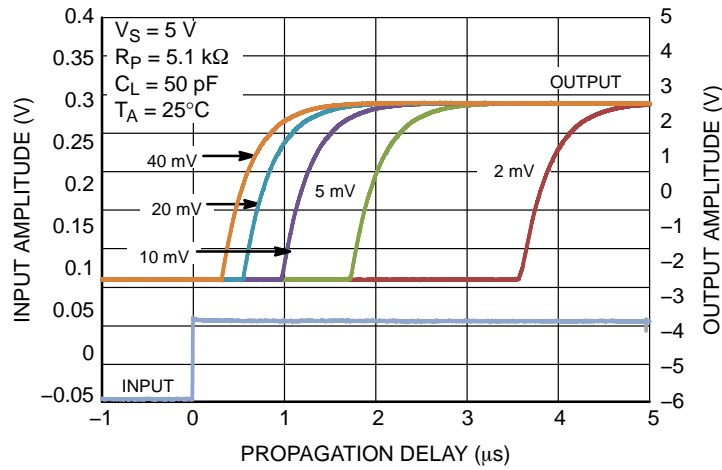

Figure 7. t_{pLH} vs. Overdrive

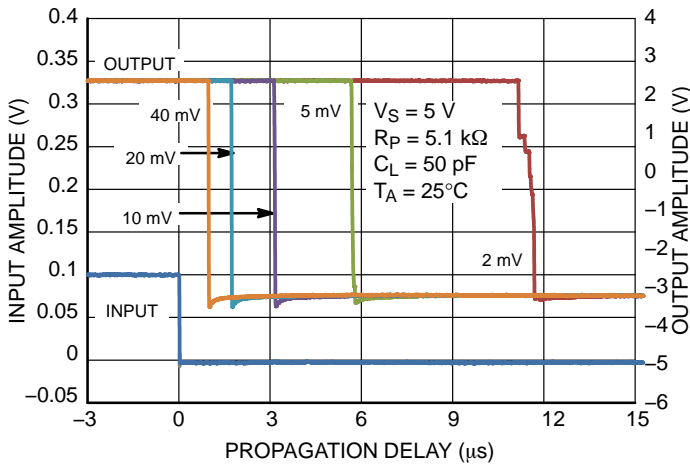

Figure 8. t_{pHL} vs. Overdrive

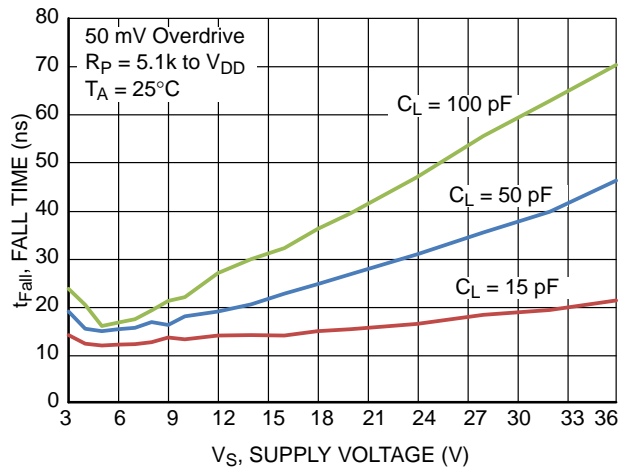

Figure 9. Fall Time vs. V_S

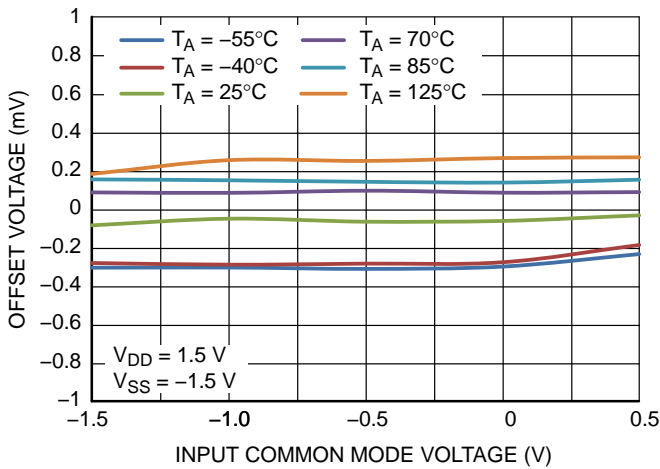

Figure 10. V_{OS} vs. V_{CM} ($V_S = 3 V$)

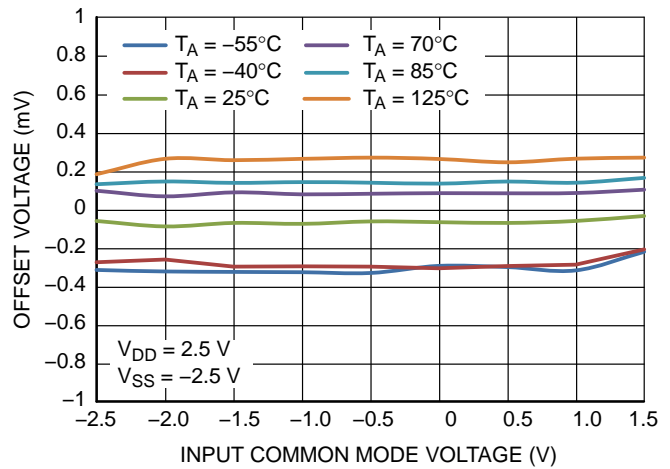

Figure 11. V_{OS} vs. V_{CM} ($V_S = 5 V$)

NCV2393, TS393

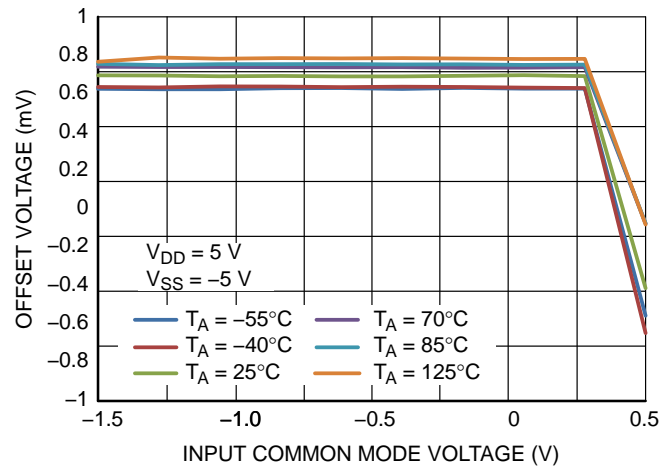
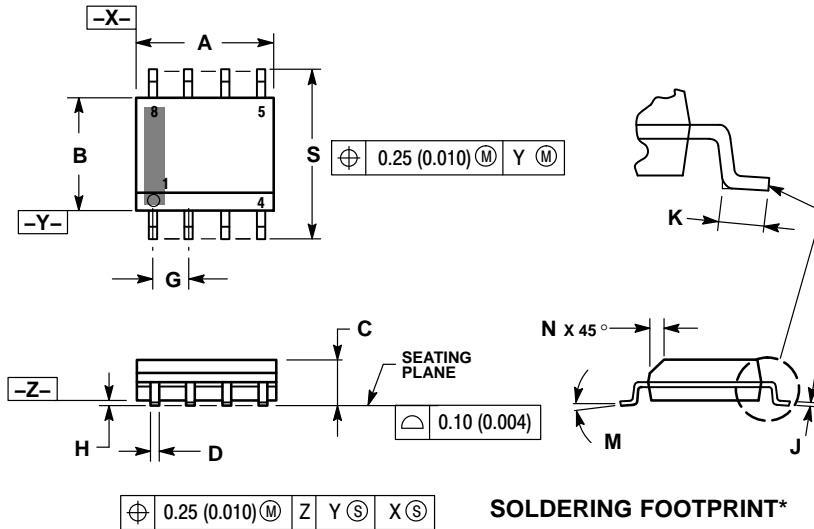

Figure 12. V_{OS} vs. V_{CM} ($V_S = 10\text{ V}$)

NCV2393, TS393

PACKAGE DIMENSIONS

SOIC-8 NB
CASE 751-07
ISSUE AK



NOTES:

1. DIMENSIONING AND TOLERANCING PER ANSI Y14.5M, 1982.
2. CONTROLLING DIMENSION: MILLIMETER.
3. DIMENSION A AND B DO NOT INCLUDE MOLD PROTRUSION.
4. MAXIMUM MOLD PROTRUSION 0.15 (0.006) PER SIDE.
5. DIMENSION D DOES NOT INCLUDE DAMBAR PROTRUSION. ALLOWABLE DAMBAR PROTRUSION SHALL BE 0.127 (0.005) TOTAL IN EXCESS OF THE D DIMENSION AT MAXIMUM MATERIAL CONDITION.
6. 751-01 THRU 751-06 ARE OBSOLETE. NEW STANDARD IS 751-07.

DIM	MILLIMETERS		INCHES	
	MIN	MAX	MIN	MAX
A	4.80	5.00	0.189	0.197
B	3.80	4.00	0.150	0.157
C	1.35	1.75	0.053	0.069
D	0.33	0.51	0.013	0.020
G	1.27 BSC		0.050 BSC	
H	0.10	0.25	0.004	0.010
J	0.19	0.25	0.007	0.010
K	0.40	1.27	0.016	0.050
M	0°	8°	0°	8°
N	0.25	0.50	0.010	0.020
S	5.80	6.20	0.228	0.244

SOLDERING FOOTPRINT*

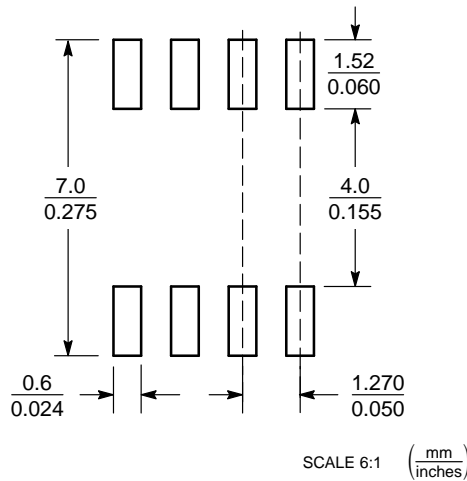

*For additional information on our Pb-Free strategy and soldering details, please download the ON Semiconductor Soldering and Mounting Techniques Reference Manual, SOLDERRM/D.

ON Semiconductor and are registered trademarks of Semiconductor Components Industries, LLC (SCILLC). SCILLC owns the rights to a number of patents, trademarks, copyrights, trade secrets, and other intellectual property. A listing of SCILLC's product/patent coverage may be accessed at www.onsemi.com/site/pdf/Patent-Marking.pdf. SCILLC reserves the right to make changes without further notice to any products herein. SCILLC makes no warranty, representation or guarantee regarding the suitability of its products for any particular purpose, nor does SCILLC assume any liability arising out of the application or use of any product or circuit, and specifically disclaims any and all liability, including without limitation special, consequential or incidental damages. "Typical" parameters which may be provided in SCILLC data sheets and/or specifications can and do vary in different applications and actual performance may vary over time. All operating parameters, including "Typicals" must be validated for each customer application by customer's technical experts. SCILLC does not convey any license under its patent rights nor the rights of others. SCILLC products are not designed, intended, or authorized for use as components in systems intended for surgical implant into the body, or other applications intended to support or sustain life, or for any other application in which the failure of the SCILLC product could create a situation where personal injury or death may occur. Should Buyer purchase or use SCILLC products for any such unintended or unauthorized application, Buyer shall indemnify and hold SCILLC and its officers, employees, subsidiaries, affiliates, and distributors harmless against all claims, costs, damages, and expenses, and reasonable attorney fees arising out of, directly or indirectly, any claim of personal injury or death associated with such unintended or unauthorized use, even if such claim alleges that SCILLC was negligent regarding the design or manufacture of the part. SCILLC is an Equal Opportunity/Affirmative Action Employer. This literature is subject to all applicable copyright laws and is not for resale in any manner.

PUBLICATION ORDERING INFORMATION

LITERATURE FULFILLMENT:
Literature Distribution Center for ON Semiconductor
P.O. Box 5163, Denver, Colorado 80217 USA
Phone: 303-675-2175 or 800-344-3860 Toll Free USA/Canada
Fax: 303-675-2176 or 800-344-3867 Toll Free USA/Canada
Email: orderlit@onsemi.com

N. American Technical Support: 800-282-9855 Toll Free
USA/Canada
Europe, Middle East and Africa Technical Support:
Phone: 421 33 790 2910
Japan Customer Focus Center
Phone: 81-3-5817-1050

ON Semiconductor Website: www.onsemi.com
Order Literature: <http://www.onsemi.com/orderlit>
For additional information, please contact your local Sales Representative

Компания «Life Electronics» занимается поставками электронных компонентов импортного и отечественного производства от производителей и со складов крупных дистрибьюторов Европы, Америки и Азии.

С конца 2013 года компания активно расширяет линейку поставок компонентов по направлению коаксиальный кабель, кварцевые генераторы и конденсаторы (керамические, пленочные, электролитические), за счёт заключения дистрибьюторских договоров

Мы предлагаем:

- Конкурентоспособные цены и скидки постоянным клиентам.
- Специальные условия для постоянных клиентов.
- Подбор аналогов.
- Поставку компонентов в любых объемах, удовлетворяющих вашим потребностям.
- Приемлемые сроки поставки, возможна ускоренная поставка.
- Доставку товара в любую точку России и стран СНГ.
- Комплексную поставку.
- Работу по проектам и поставку образцов.
- Формирование склада под заказчика.
- Сертификаты соответствия на поставляемую продукцию (по желанию клиента).
- Тестирование поставляемой продукции.
- Поставку компонентов, требующих военную и космическую приемку.
- Входной контроль качества.
- Наличие сертификата ISO.

В составе нашей компании организован Конструкторский отдел, призванный помогать разработчикам, и инженерам.

Конструкторский отдел помогает осуществить:

- Регистрацию проекта у производителя компонентов.
- Техническую поддержку проекта.
- Защиту от снятия компонента с производства.
- Оценку стоимости проекта по компонентам.
- Изготовление тестовой платы монтаж и пусконаладочные работы.



Тел: +7 (812) 336 43 04 (многоканальный)
Email: org@lifeelectronics.ru