



N-Channel Enhancement-Mode Vertical DMOS FETs

Features

- ▶ Free from secondary breakdown
- ▶ Low power drive requirement
- ▶ Ease of paralleling
- ▶ Low C_{iss} and fast switching speeds
- ▶ High input impedance and high gain

Applications

- ▶ Motor controls
- ▶ Converters
- ▶ Amplifiers
- ▶ Switches
- ▶ Power supply circuits
- ▶ Drivers (relays, hammers, solenoids, lamps, memories, displays, bipolar transistors, etc.)

General Description

The Supertex VN2106 is an enhancement-mode (normally-off) transistor that utilizes a vertical DMOS structure and Supertex’s well-proven silicon-gate manufacturing process. This combination produces a device with the power handling capabilities of bipolar transistors, and the high input impedance and positive temperature coefficient inherent in MOS devices. Characteristic of all MOS structures, this device is free from thermal runaway and thermally-induced secondary breakdown.

Supertex’s vertical DMOS FETs are ideally suited to a wide range of switching and amplifying applications where very low threshold voltage, high breakdown voltage, high input impedance, low input capacitance, and fast switching speeds are desired.

Ordering Information

Device	Package Option	BV_{DSS}/BV_{DGS} (V)	$R_{DS(ON)}$ (max) (Ω)
	TO-92		
VN2106	VN2106N3-G	60	4.0

-G indicates package is RoHS compliant ("Green")



Absolute Maximum Ratings

Parameter	Value
Drain-to-Source voltage	BV_{DSS}
Drain-to-Gate voltage	BV_{DGS}
Gate-to-Source voltage	$\pm 20V$
Operating and storage temperature	$-55^{\circ}C$ to $+150^{\circ}C$
Soldering temperature*	$+300^{\circ}C$

Absolute Maximum Ratings are those values beyond which damage to the device may occur. Functional operation under these conditions is not implied. Continuous operation of the device at the absolute rating level may affect device reliability. All voltages are referenced to device ground.

* Distance of 1.6mm from case for 10 seconds.

Pin Configuration

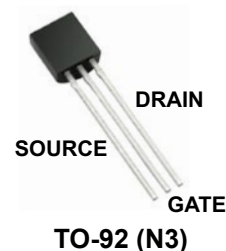

Product Marking

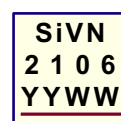

YY = Year Sealed
 WW = Week Sealed
 _____ = "Green" Packaging

Package may or may not include the following marks: Si or

TO-92 (N3)

Thermal Characteristics

Package	I_D (continuous) [†] (mA)	I_D (pulsed) (A)	Power Dissipation @ $T_c = 25^\circ\text{C}$ (W)	θ_{jc} ($^\circ\text{C}/\text{W}$)	θ_{ja} ($^\circ\text{C}/\text{W}$)	I_{DR}^{\dagger} (mA)	I_{DRM} (A)
TO-92	300	1.0	1.0	125	170	300	1.0

Notes:

[†] I_D (continuous) is limited by max rated T_j .

Electrical Characteristics ($T_A = 25^\circ\text{C}$ unless otherwise specified)

Sym	Parameter	Min	Typ	Max	Units	Conditions
BV_{DSS}	Drain-to-source breakdown voltage	60	-	-	V	$V_{GS} = 0V, I_D = 1.0\text{mA}$
$V_{GS(th)}$	Gate threshold voltage	0.8	-	2.4	V	$V_{GS} = V_{DS}, I_D = 1.0\text{mA}$
$\Delta V_{GS(th)}$	Change in $V_{GS(th)}$ with temperature	-	-3.8	-5.5	mV/ $^\circ\text{C}$	$V_{GS} = V_{DS}, I_D = 1.0\text{mA}$
I_{GSS}	Gate body leakage current	-	0.1	100	nA	$V_{GS} = \pm 20V, V_{DS} = 0V$
I_{DSS}	Zero gate voltage drain current	-	-	1.0	μA	$V_{GS} = 0V, V_{DS} = \text{Max Rating}$
		-	-	100		$V_{DS} = 0.8 \text{ Max Rating}, V_{GS} = 0V, T_A = 125^\circ\text{C}$
$I_{D(ON)}$	On-state drain current	0.6	-	-	A	$V_{GS} = 10V, V_{DS} = 25V$
$R_{DS(ON)}$	Static drain-to-source on-state resistance	-	4.5	6.0	Ω	$V_{GS} = 5.0V, I_D = 75\text{mA}$
		-	3.0	4.0		$V_{GS} = 10V, I_D = 500\text{mA}$
$\Delta R_{DS(ON)}$	Change in $R_{DS(ON)}$ with temperature	-	0.7	1.0	%/ $^\circ\text{C}$	$V_{GS} = 10V, I_D = 500\text{mA}$
G_{FS}	Forward transconductance	150	400	-	mmho	$V_{DS} = 25V, I_D = 500\text{mA}$
C_{ISS}	Input capacitance	-	35	50	pF	$V_{GS} = 0V, V_{DS} = 25V, f = 1.0\text{MHz}$
C_{OSS}	Common source output capacitance	-	13	25		
C_{RSS}	Reverse transfer capacitance	-	4.0	5.0		
$t_{d(ON)}$	Turn-on delay time	-	3.0	5.0	ns	$V_{DD} = 25V, I_D = 600\text{mA}, R_{GEN} = 25\Omega$
t_r	Rise time	-	5.0	8.0		
$t_{d(OFF)}$	Turn-off delay time	-	6.0	9.0		
t_f	Fall time	-	5.0	8.0		
V_{SD}	Diode forward voltage drop	-	1.2	1.8	V	$V_{GS} = 0V, I_{SD} = 600\text{mA}$
t_{rr}	Reverse recovery time	-	400	-	ns	$V_{GS} = 0V, I_{SD} = 600\text{mA}$

Notes:

1. All D.C. parameters 100% tested at 25°C unless otherwise stated. (Pulse test: $300\mu\text{s}$ pulse, 2% duty cycle.)
2. All A.C. parameters sample tested.

Switching Waveforms and Test Circuit

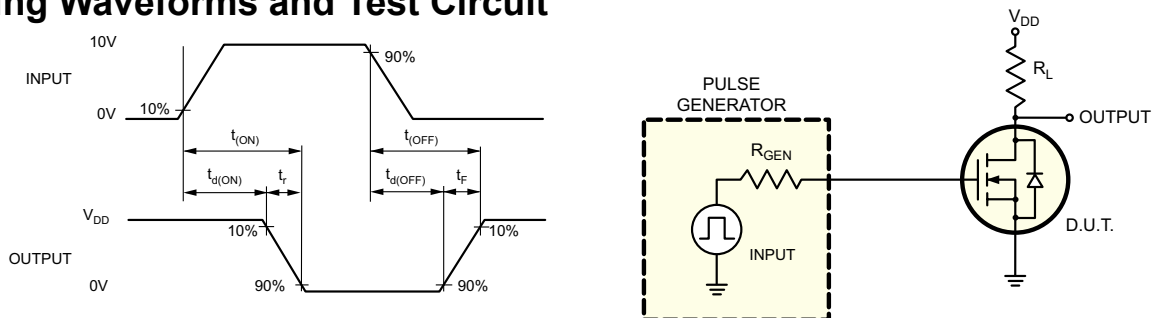

Typical Performance Curves

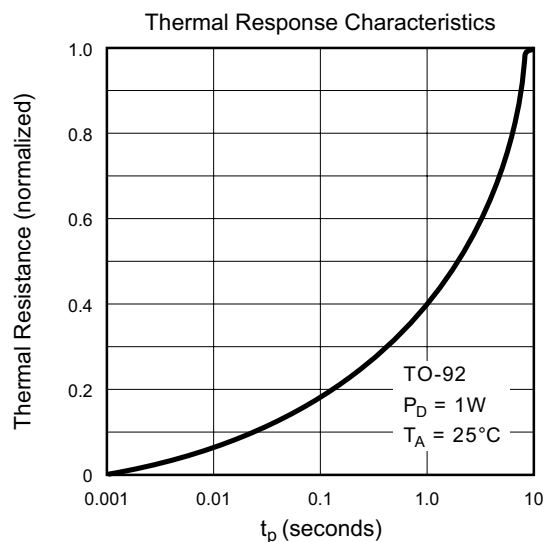
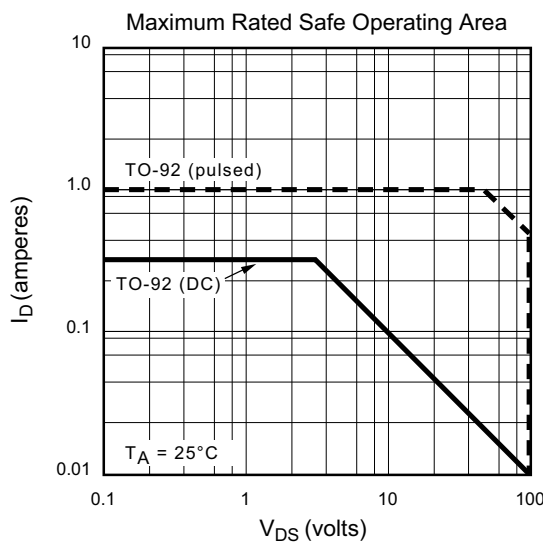
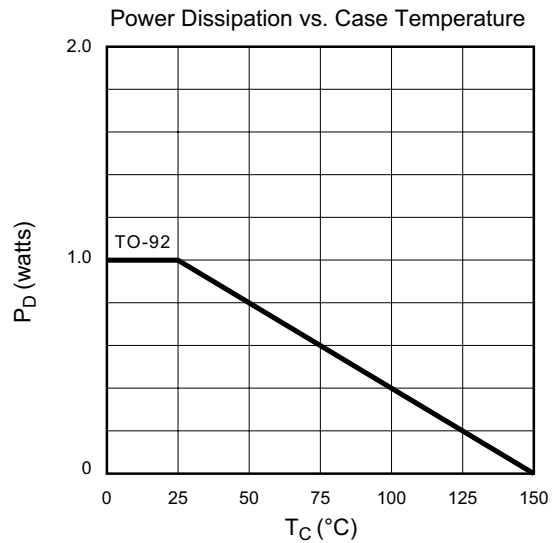
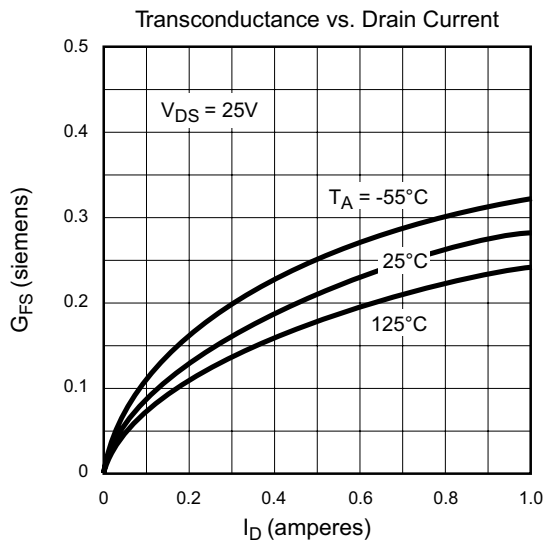
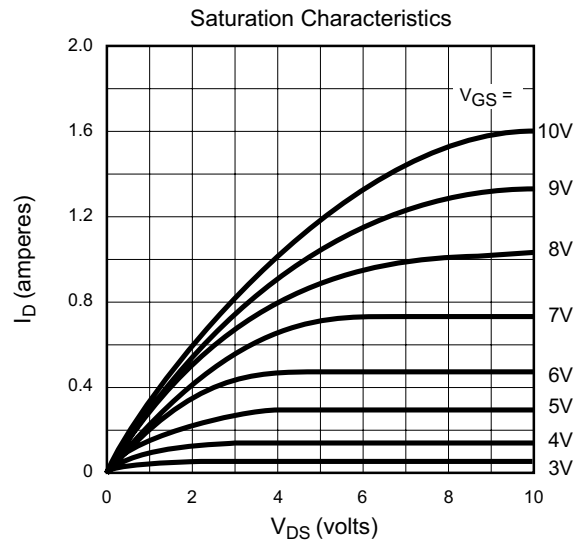
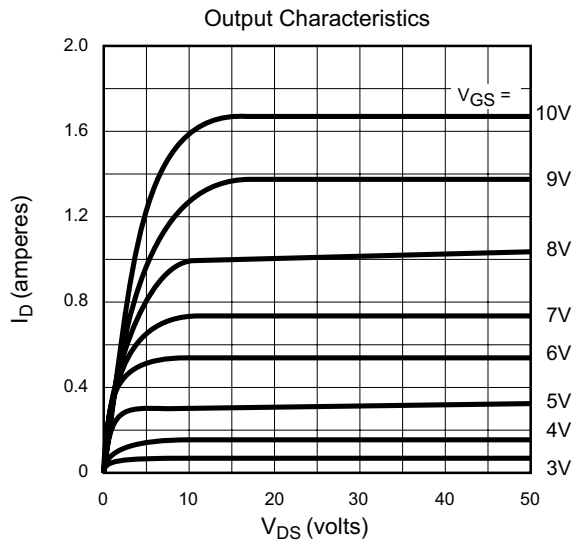

Typical Performance Curves (cont.)

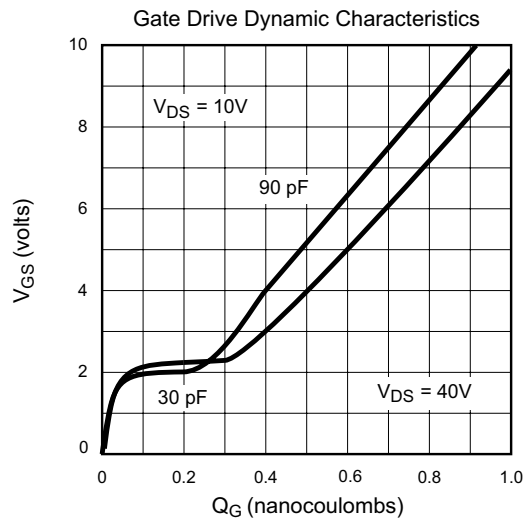
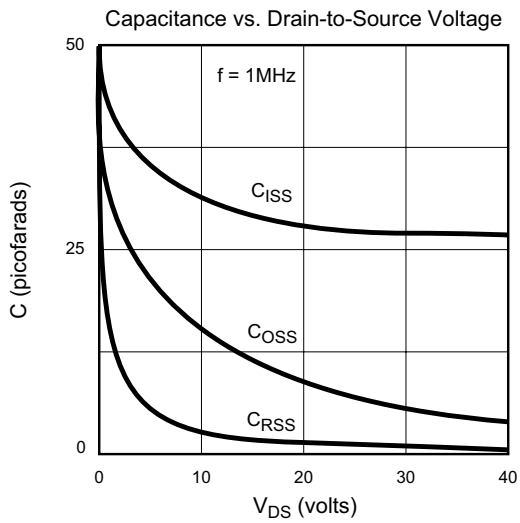
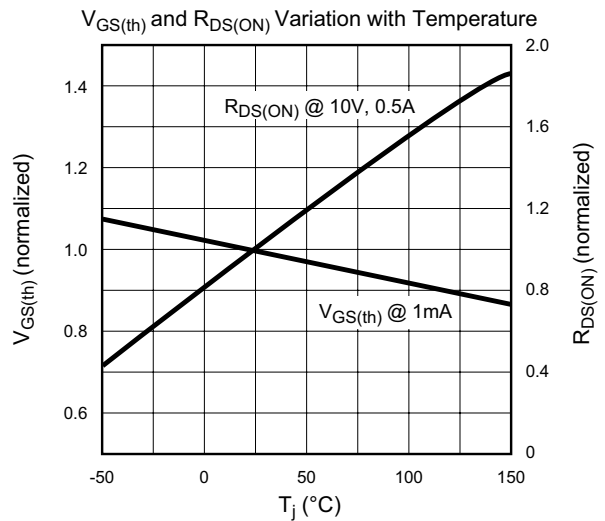
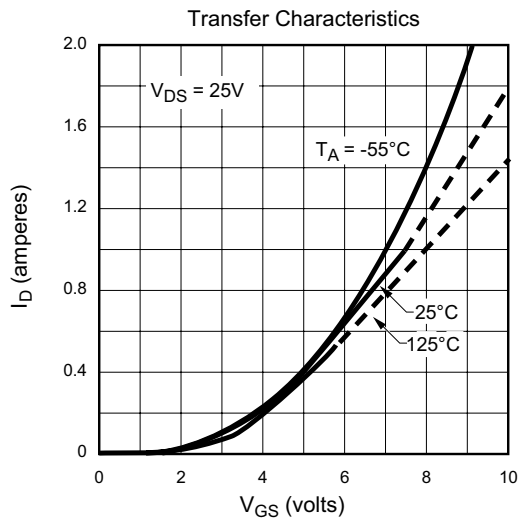
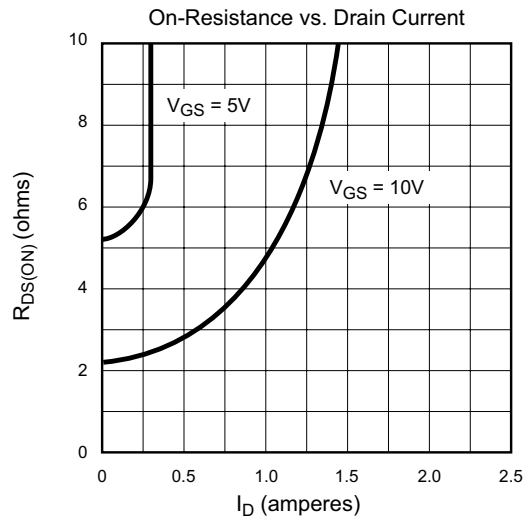
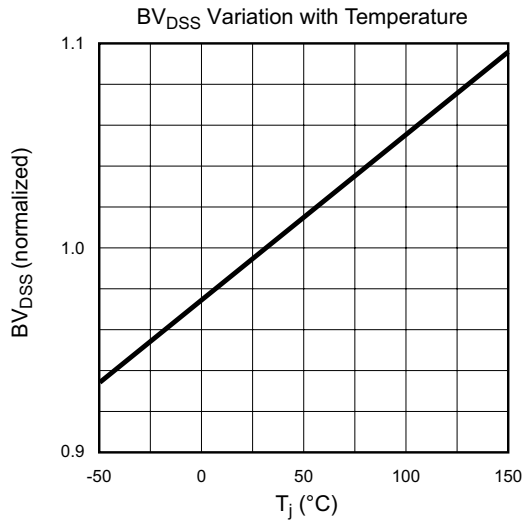

3-Lead TO-92 Package Outline (N3)

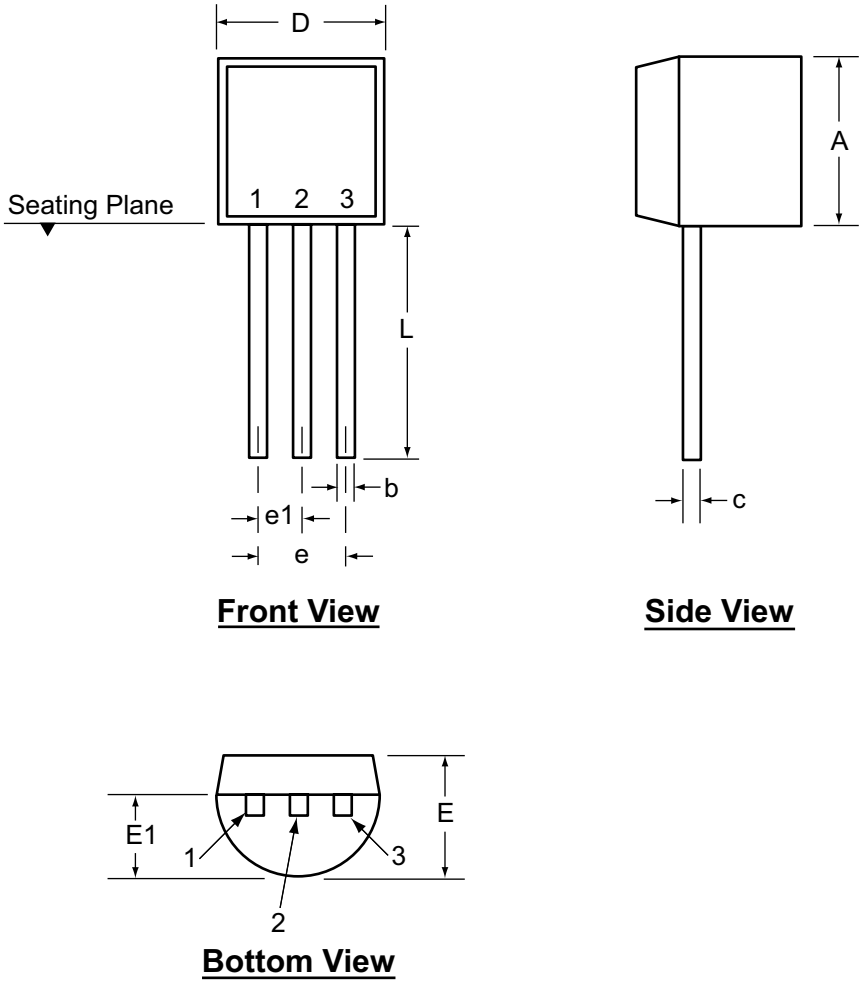

Symbol	A	b	c	D	E	E1	e	e1	L
Dimensions (inches)	MIN	.170	.014†	.175	.125	.080	.095	.045	.500
	NOM	-	-	-	-	-	-	-	-
	MAX	.210	.022†	.022†	.205	.165	.105	.105	.610*

JEDEC Registration TO-92.
 * This dimension is not specified in the original JEDEC drawing. The value listed is for reference only.
 † This dimension is a non-JEDEC dimension.
Drawings not to scale.
Supertex Doc.#: DSPD-3TO92N3, Version D080408.

(The package drawing(s) in this data sheet may not reflect the most current specifications. For the latest package outline information go to <http://www.supertex.com/packaging.html>.)

Supertex inc. does not recommend the use of its products in life support applications, and will not knowingly sell them for use in such applications unless it receives an adequate "product liability indemnification insurance agreement." Supertex inc. does not assume responsibility for use of devices described, and limits its liability to the replacement of the devices determined defective due to workmanship. No responsibility is assumed for possible omissions and inaccuracies. Circuitry and specifications are subject to change without notice. For the latest product specifications refer to the Supertex inc. website: <http://www.supertex.com>.

Компания «Life Electronics» занимается поставками электронных компонентов импортного и отечественного производства от производителей и со складов крупных дистрибьюторов Европы, Америки и Азии.

С конца 2013 года компания активно расширяет линейку поставок компонентов по направлению коаксиальный кабель, кварцевые генераторы и конденсаторы (керамические, пленочные, электролитические), за счёт заключения дистрибьюторских договоров

Мы предлагаем:

- Конкурентоспособные цены и скидки постоянным клиентам.
- Специальные условия для постоянных клиентов.
- Подбор аналогов.
- Поставку компонентов в любых объемах, удовлетворяющих вашим потребностям.
- Приемлемые сроки поставки, возможна ускоренная поставка.
- Доставку товара в любую точку России и стран СНГ.
- Комплексную поставку.
- Работу по проектам и поставку образцов.
- Формирование склада под заказчика.
- Сертификаты соответствия на поставляемую продукцию (по желанию клиента).
- Тестирование поставляемой продукции.
- Поставку компонентов, требующих военную и космическую приемку.
- Входной контроль качества.
- Наличие сертификата ISO.

В составе нашей компании организован Конструкторский отдел, призванный помогать разработчикам, и инженерам.

Конструкторский отдел помогает осуществить:

- Регистрацию проекта у производителя компонентов.
- Техническую поддержку проекта.
- Защиту от снятия компонента с производства.
- Оценку стоимости проекта по компонентам.
- Изготовление тестовой платы монтаж и пусконаладочные работы.



Тел: +7 (812) 336 43 04 (многоканальный)

Email: org@lifeelectronics.ru