

MMIC VCO w/ HALF FREQUENCY OUTPUT & DIVIDE-BY-4, 13.6 - 14.9 GHz



Typical Applications

Low noise MMIC VCO w/Half Frequency, Divide-by-4 Outputs for:

- VSAT Radio
- Point to Point/Multipoint Radio
- Test Equipment & Industrial Controls
- Military End-Use

Features

- Dual Output: $F_o = 13.6 - 14.9$ GHz
 $F_o/2 = 6.8 - 7.45$ GHz
- Pout: +7 dBm
- Phase Noise: -110 dBc/Hz @100 kHz Typ.
- No External Resonator Needed
- 32 Lead 5x5mm SMT Package: 25mm²

Functional Diagram

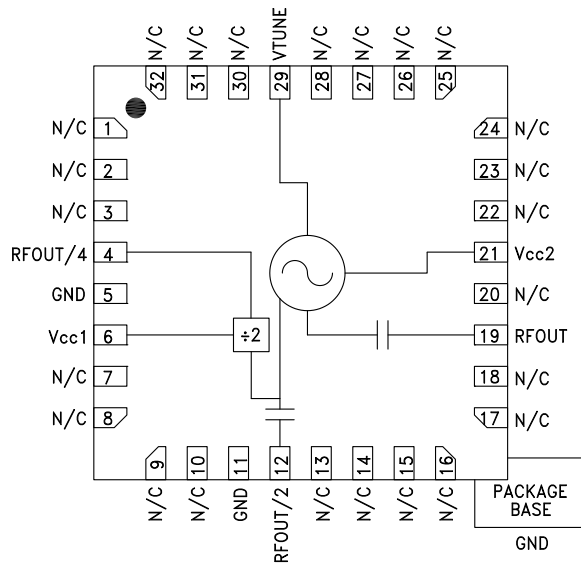

General Description

The HMC531LP5 & HMC531LP5E are GaAs InGaP Heterojunction Bipolar Transistor (HBT) MMIC VCOs. The HMC531LP5 & HMC531LP5E integrate resonators, negative resistance devices, varactor diodes and feature half frequency and divide-by-4 outputs. The VCO's phase noise performance is excellent over temperature, shock, and process due to the oscillator's monolithic structure. Power output is +7 dBm typical from a +5V supply voltage. The prescaler function can be disabled to conserve current if not required. The voltage controlled oscillator is packaged in a leadless QFN 5x5 mm surface mount package, and requires no external matching components.

Electrical Specifications, $T_A = +25^\circ C$, $V_{cc1}, V_{cc2} = +5V$

Parameter	Min.	Typ.	Max.	Units	
Frequency Range		13.6 - 14.9		GHz	
		6.8 - 7.45		GHz	
Power Output					
RFOUT	+3		+10	dBm	
RFOUT/2	+8		+14	dBm	
RFOUT/4	-9		-3	dBm	
SSB Phase Noise @ 100 kHz Offset, $V_{tune} = +5V$ @ RFOUT		-110		dBc/Hz	
Tune Voltage	V_{tune}	2	13	V	
Supply Current	I_{cc1} & I_{cc2}	220	260	300	mA
Tune Port Leakage Current ($V_{tune} = 13V$)			10	μA	
Output Return Loss		8		dB	
Harmonics/Subharmonics					
	1/2	25		dBc	
	3/2	35		dBc	
	2nd	18		dBc	
	3rd	40		dBc	
Pulling (into a 2.0:1 VSWR)		5		MHz pp	
Pushing @ $V_{tune} = 5V$		6		MHz/V	
Frequency Drift Rate		1.2		MHz/ $^\circ C$	

Information furnished by Analog Devices is believed to be accurate and reliable. However, no responsibility is assumed by Analog Devices for its use, nor for any infringements of patents or other rights of third parties that may result from its use. Specifications subject to change without notice. No license is granted by implication or otherwise under any patent or patent rights of Analog Devices. Trademarks and registered trademarks are the property of their respective owners.

For price, delivery, and to place orders: Analog Devices, Inc., One Technology Way, P.O. Box 9106, Norwood, MA 02062-9106
Phone: 781-329-4700 • Order online at www.analog.com
Application Support: Phone: 1-800-ANALOG-D



MMIC VCO w/ HALF FREQUENCY OUTPUT & DIVIDE-BY-4, 13.6 - 14.9 GHz

Frequency vs. Tuning Voltage, Vcc = +5V

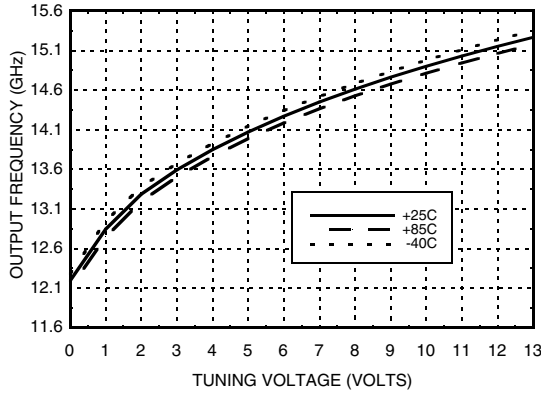

Frequency vs. Tuning Voltage, T = 25°C

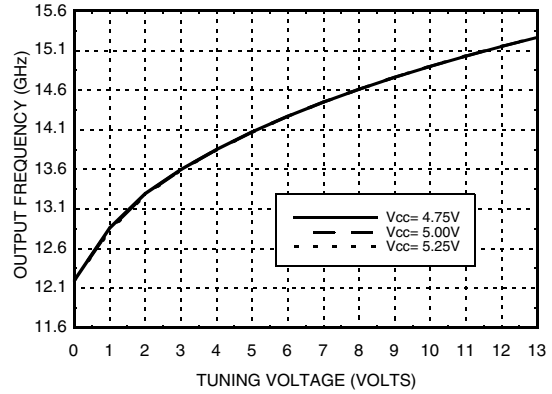

Sensitivity vs. Tuning Voltage, Vcc = +5V

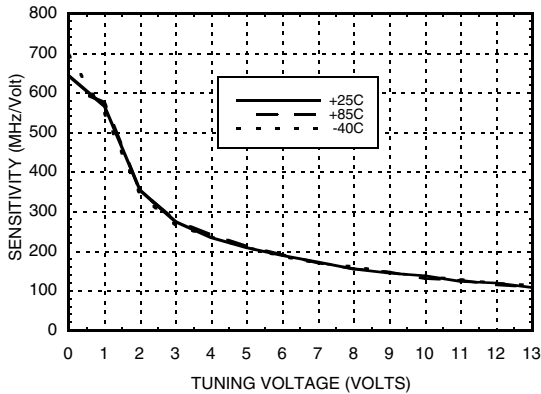

Output Power vs. Tuning Voltage, Vcc = +5V

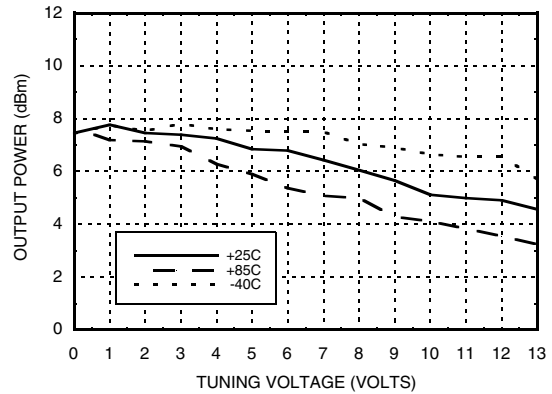

SSB Phase Noise vs. Tuning Voltage

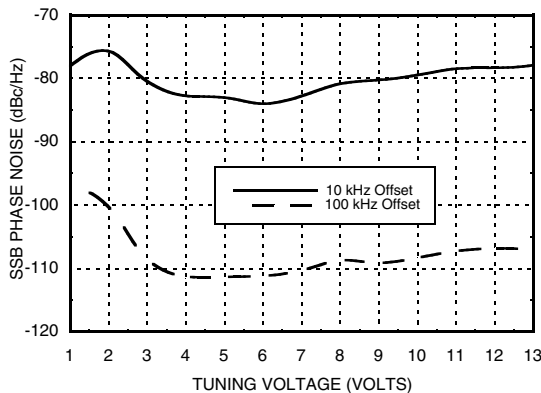

SSB Phase Noise @ Vtune = +5V

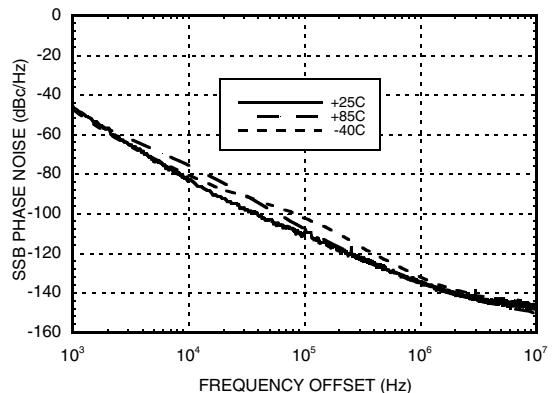

Information furnished by Analog Devices is believed to be accurate and reliable. However, no responsibility is assumed by Analog Devices for its use, nor for any infringements of patents or other rights of third parties that may result from its use. Specifications subject to change without notice. No license is granted by implication or otherwise under any patent or patent rights of Analog Devices. Trademarks and registered trademarks are the property of their respective owners.

For price, delivery, and to place orders: Analog Devices, Inc., One Technology Way, P.O. Box 9106, Norwood, MA 02062-9106 Phone: 781-329-4700 • Order online at www.analog.com Application Support: Phone: 1-800-ANALOG-D

MMIC VCO w/ HALF FREQUENCY OUTPUT & DIVIDE-BY-4, 13.6 - 14.9 GHz



RFOUT/2 Frequency vs. Tuning Voltage, Vcc= +5V

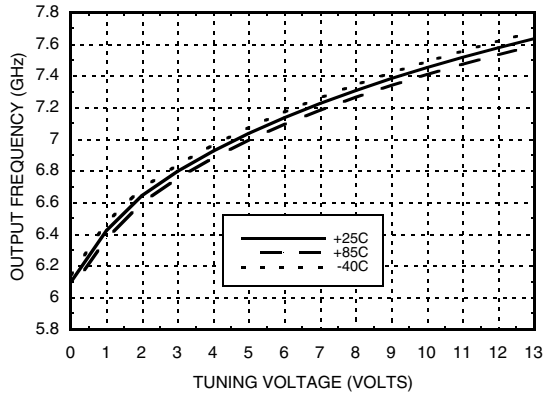

RFOUT/2 Output Power vs. Tuning Voltage, Vcc= +5V

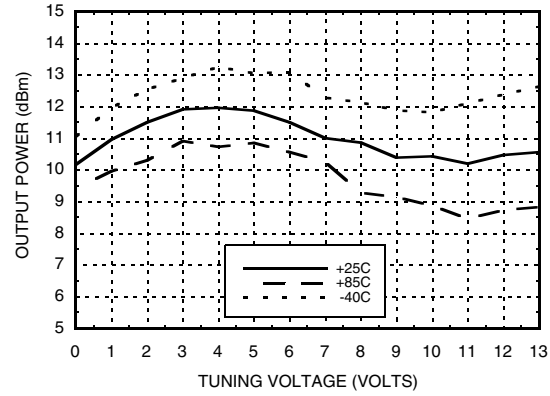

Divide-by-4 Frequency vs. Tuning Voltage, Vcc= +5V

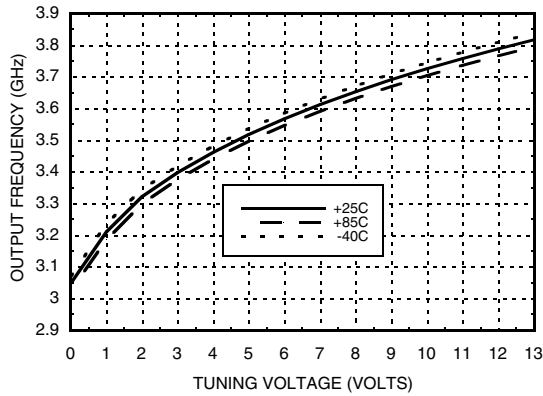

Divide-by-4 Output Power vs. Tuning Voltage, Vcc= +5V

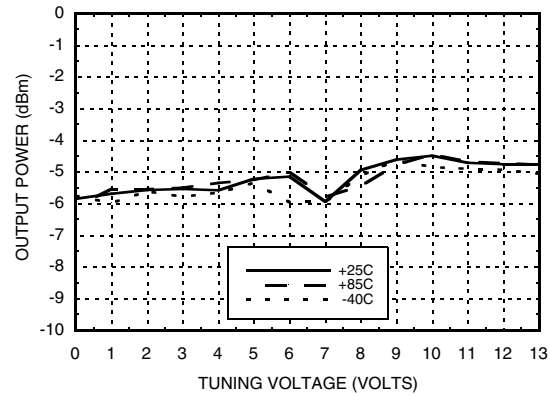

Absolute Maximum Ratings

Vcc1, Vcc2	+5.5 Vdc
Vtune	0 to +15V
Junction Temperature	135 °C
Continuous P _{diss} (T=85 °C) (derate 37 mW/C above 85 °C)	1.85 W
Thermal Resistance (junction to ground paddle)	27 °C/W
Storage Temperature	-65 to +150 °C
Operating Temperature	-40 to +85 °C
ESD Sensitivity (HBM)	Class 1A

Typical Supply Current vs. Vcc

Vcc (V)	I _{cc} (mA)
4.75	235
5.00	260
5.25	275

Note: VCO will operate over full voltage range shown above.



**ELECTROSTATIC SENSITIVE DEVICE
OBSERVE HANDLING PRECAUTIONS**

MMIC VCO w/ HALF FREQUENCY OUTPUT & DIVIDE-BY-4, 13.6 - 14.9 GHz



Outline Drawing

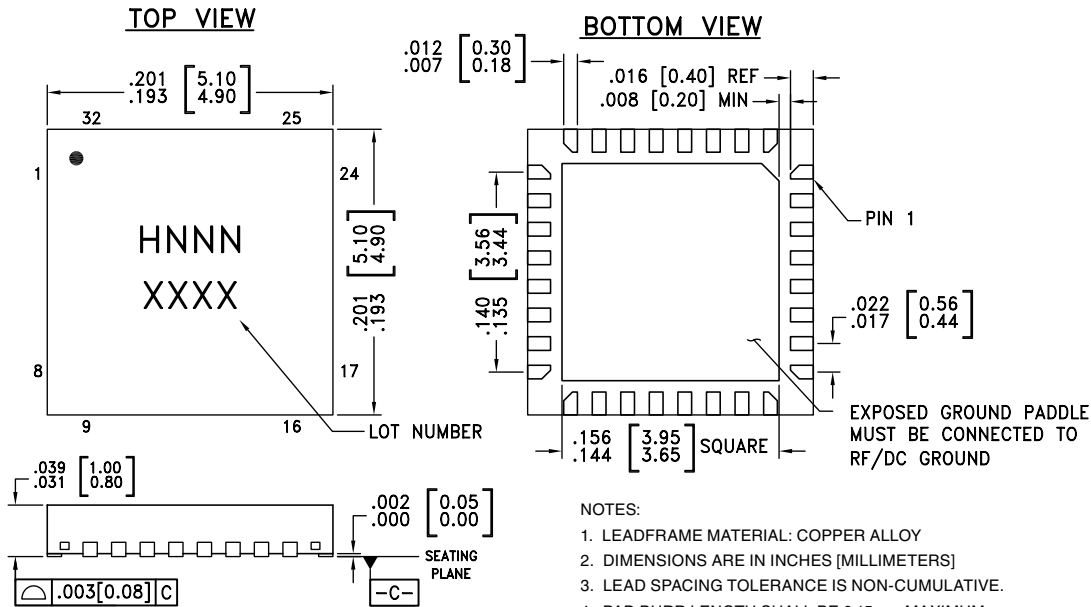

- NOTES:
1. LEADFRAME MATERIAL: COPPER ALLOY
 2. DIMENSIONS ARE IN INCHES [MILLIMETERS]
 3. LEAD SPACING TOLERANCE IS NON-CUMULATIVE.
 4. PAD BURR LENGTH SHALL BE 0.15mm MAXIMUM. PAD BURR HEIGHT SHALL BE 0.05mm MAXIMUM.
 5. PACKAGE WARP SHALL NOT EXCEED 0.05mm.
 6. ALL GROUND LEADS AND GROUND PADDLE MUST BE SOLDERED TO PCB RF GROUND.
 7. REFER TO HITTITE APPLICATION NOTE FOR SUGGESTED LAND PATTERN.

Package Information

Part Number	Package Body Material	Lead Finish	MSL Rating	Package Marking ^[3]
HMC531LP5	Low Stress Injection Molded Plastic	Sn/Pb Solder	MSL3 ^[1]	H531 XXXX
HMC531LP5E	RoHS-compliant Low Stress Injection Molded Plastic	100% matte Sn	MSL3 ^[2]	H531 XXXX

- [1] Max peak reflow temperature of 235 °C
 [2] Max peak reflow temperature of 260 °C
 [3] 4-Digit lot number XXXX

Pin Descriptions

Pin Number	Function	Description	Interface Schematic
1 - 3, 7 - 10, 13 - 18, 20, 22 - 28, 30 - 32	N/C	No Connection. These pins may be connected to RF/DC ground. Performance will not be affected.	
4	RFOUT/4	Divide-by-4 Output.	
6	Vcc1	Supply Voltage for prescaler. If prescaler is not required, this pin may be left open to conserve 65 mA of current.	

Information furnished by Analog Devices is believed to be accurate and reliable. However, no responsibility is assumed by Analog Devices for its use, nor for any infringements of patents or other rights of third parties that may result from its use. Specifications subject to change without notice. No license is granted by implication or otherwise under any patent or patent rights of Analog Devices. Trademarks and registered trademarks are the property of their respective owners.

For price, delivery, and to place orders: Analog Devices, Inc., One Technology Way, P.O. Box 9106, Norwood, MA 02062-9106 Phone: 781-329-4700 • Order online at www.analog.com Application Support: Phone: 1-800-ANALOG-D



MMIC VCO w/ HALF FREQUENCY OUTPUT & DIVIDE-BY-4, 13.6 - 14.9 GHz

Pin Descriptions

Pin Number	Function	Description	Interface Schematic
12	RFOUT/2	Half frequency output (AC coupled).	
19	RF OUT	RF output (AC coupled).	
21	Vcc2	Supply Voltage, +5V	
29	VTUNE	Control Voltage and Modulation Input. Modulation bandwidth dependent on drive source impedance. See "Determining the FM Bandwidth of a Wideband Varactor Tuned VCO" application note.	
5, 11 Paddle	GND	Package bottom has an exposed metal paddle that must be connected to RF/DC ground.	

Typical Application Circuit

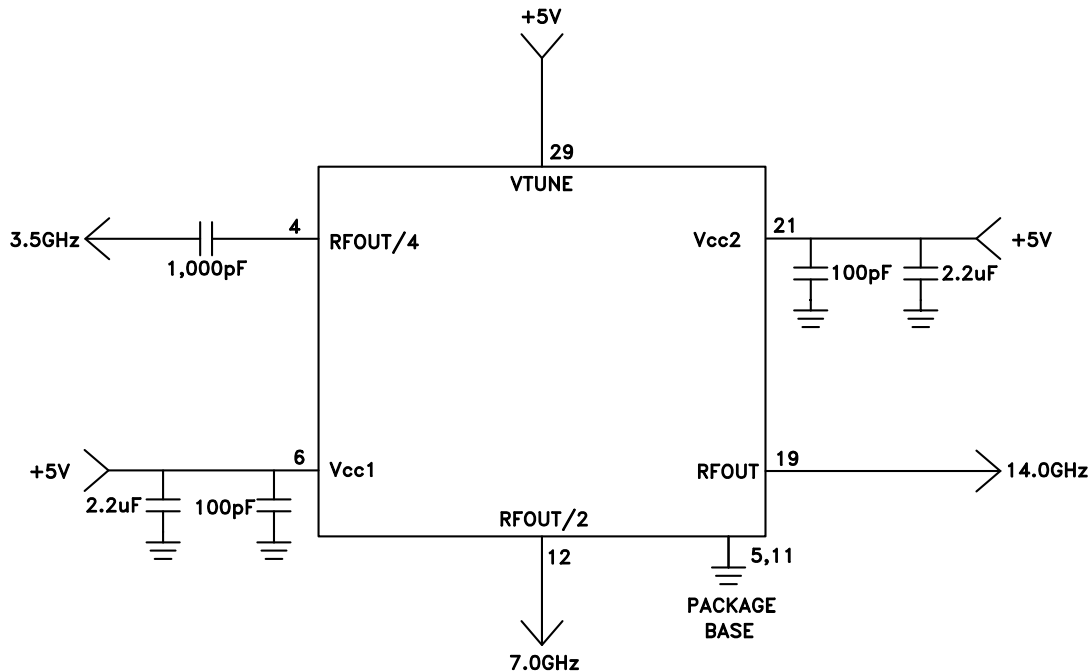

Information furnished by Analog Devices is believed to be accurate and reliable. However, no responsibility is assumed by Analog Devices for its use, nor for any infringements of patents or other rights of third parties that may result from its use. Specifications subject to change without notice. No license is granted by implication or otherwise under any patent or patent rights of Analog Devices. Trademarks and registered trademarks are the property of their respective owners.

For price, delivery, and to place orders: Analog Devices, Inc., One Technology Way, P.O. Box 9106, Norwood, MA 02062-9106 Phone: 781-329-4700 • Order online at www.analog.com Application Support: Phone: 1-800-ANALOG-D

MMIC VCO w/ HALF FREQUENCY OUTPUT & DIVIDE-BY-4, 13.6 - 14.9 GHz



Evaluation PCB

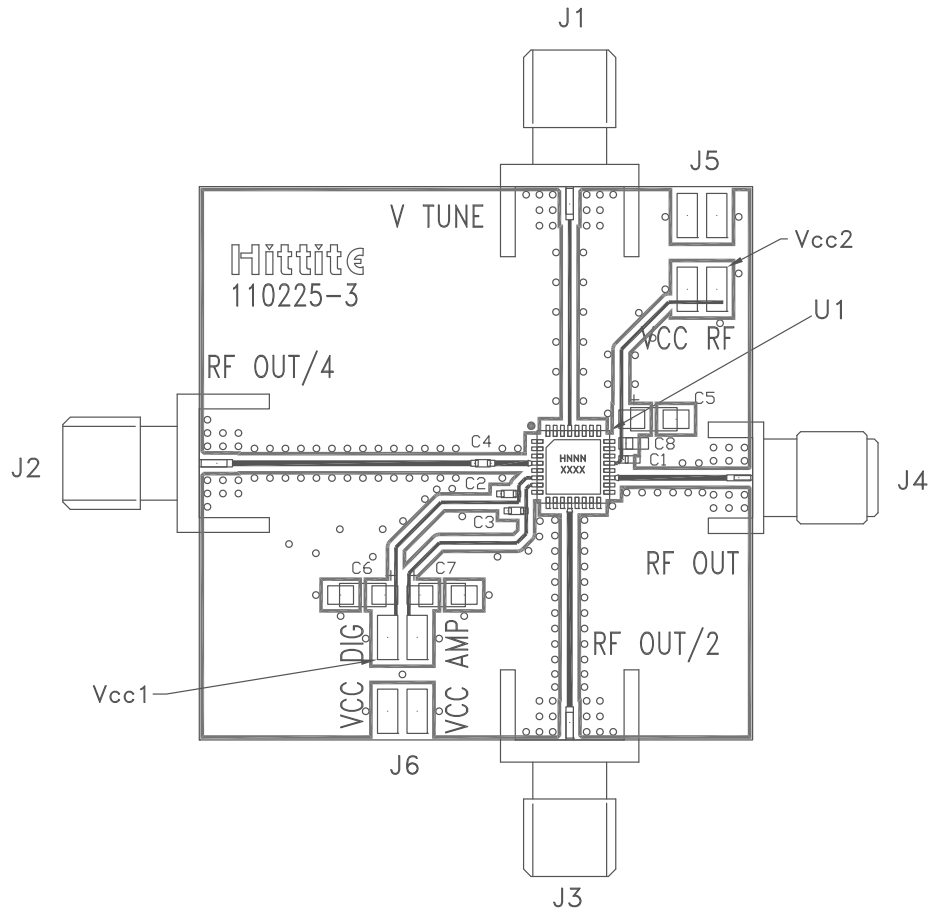

List of Materials for Evaluation PCB 110227 [1]

Item	Description
J1 - J4	PCB Mount SMA RF Connector
J5 - J6	2 mm DC Header
C1 - C3	100 pF Capacitor, 0402 Pkg.
C4	1,000 pF Capacitor, 0402 Pkg.
C5 - C7	2.2 μF Tantalum Capacitor
U1	HMC531LP5(E) VCO
PCB [2]	110225 Eval Board

[1] Reference this number when ordering complete evaluation PCB

[2] Circuit Board Material: Arlon 25FR

The circuit board used in the application should use RF circuit design techniques. Signal lines should have 50 Ohm impedance while the package ground leads and backside ground paddle should be connected directly to the ground plane similar to that shown. A sufficient number of via holes should be used to connect the top and bottom ground planes. The evaluation circuit board shown is available from Hittite upon request.

Компания «Life Electronics» занимается поставками электронных компонентов импортного и отечественного производства от производителей и со складов крупных дистрибьюторов Европы, Америки и Азии.

С конца 2013 года компания активно расширяет линейку поставок компонентов по направлению коаксиальный кабель, кварцевые генераторы и конденсаторы (керамические, пленочные, электролитические), за счёт заключения дистрибьюторских договоров

Мы предлагаем:

- Конкурентоспособные цены и скидки постоянным клиентам.
- Специальные условия для постоянных клиентов.
- Подбор аналогов.
- Поставку компонентов в любых объемах, удовлетворяющих вашим потребностям.
- Приемлемые сроки поставки, возможна ускоренная поставка.
- Доставку товара в любую точку России и стран СНГ.
- Комплексную поставку.
- Работу по проектам и поставку образцов.
- Формирование склада под заказчика.
- Сертификаты соответствия на поставляемую продукцию (по желанию клиента).
- Тестирование поставляемой продукции.
- Поставку компонентов, требующих военную и космическую приемку.
- Входной контроль качества.
- Наличие сертификата ISO.

В составе нашей компании организован Конструкторский отдел, призванный помогать разработчикам, и инженерам.

Конструкторский отдел помогает осуществить:

- Регистрацию проекта у производителя компонентов.
- Техническую поддержку проекта.
- Защиту от снятия компонента с производства.
- Оценку стоимости проекта по компонентам.
- Изготовление тестовой платы монтаж и пусконаладочные работы.



Тел: +7 (812) 336 43 04 (многоканальный)
Email: org@lifeelectronics.ru