

# Photoelectric Sensor with Separate Digital Amplifier (Laser-type) E3C-LDA

CSM\_E3C-LDA\_DS\_E\_4\_2

## Variable Laser Beam for Spot, Line, or Area Detection



- Long-distance detection (diffuse reflective: 1 m, retro-reflective: 7 m).
- Beam shape selectable from spot, line, and area types to match various applications.
- Adjustable spot diameter.
- Adjustable optical axis.
- The E3DC-LDA0, which supports the EtherCAT Sensor Communications Unit and the CompoNet Sensor Communications Unit, is also included in product lineup.



**⚠ Refer to Safety Precautions on page 9.**

For the most recent information on models that have been certified for safety standards, refer to your OMRON website.

## Features

**Diffuse Reflective Model** ■ All three beam types provide ample long-distance detection of 1,000 mm.

Sensing distance of 1 m.

Three beam types means a wider variety of applications.

### ■ Spot, Line, and Area Types

Suitable for various applications without any additional costs.

Mount Beam Units to a Spot Type Sensor to convert to Line or Area Type.

Spot Type  
E3C-LD11

Line Type  
E3C-LD21

Area Type  
E3C-LD31

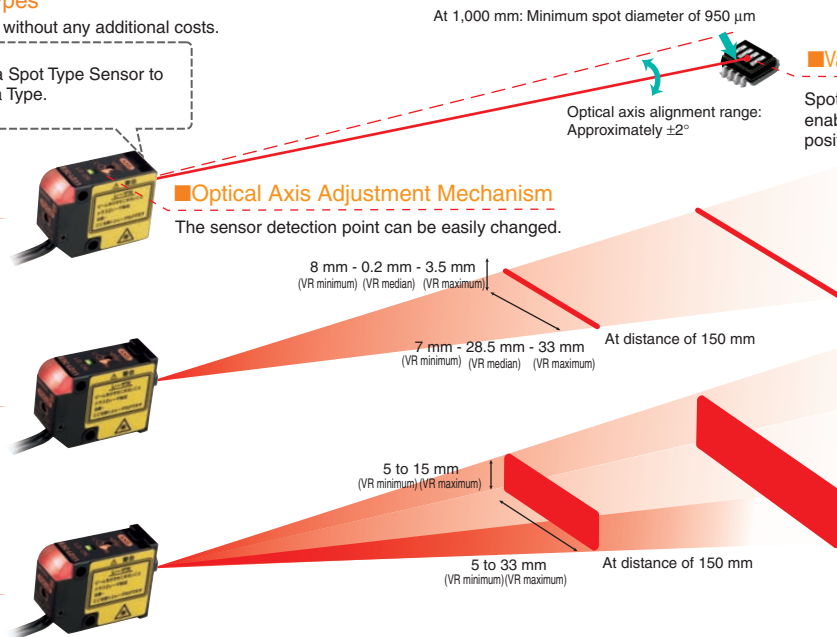

**Coaxial Retroreflective Model** ■ Easy Sensor Installation and Sensing Characteristics Equivalent to Through-beam Sensors.

Sensing distance of 7 m.



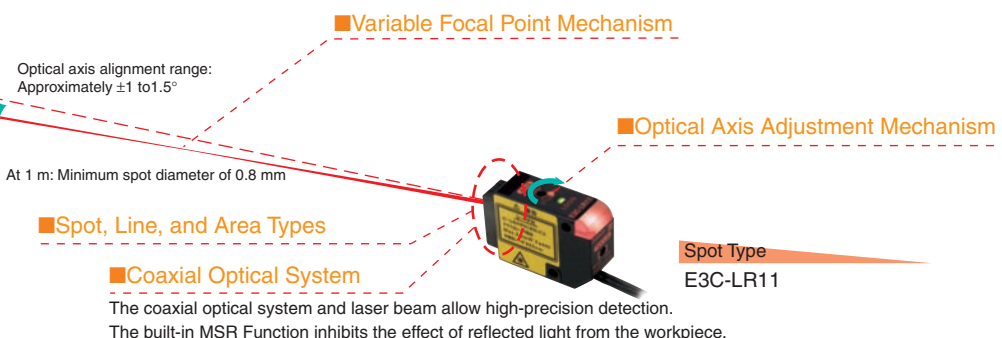

E39-R13



## Ordering Information

### Sensor Heads (Dimensions → page 12, 13)

Sensing method	Appearance	Beam shape	Model	Remarks
Diffuse-reflective		Spot (variable)	<b>E3C-LD11 2M</b>	Mounting a Beam Unit (sold separately) allows the use of line and area beams.
		Line (variable)	<b>E3C-LD21 2M</b>	This model number is for the set consisting of the E39-P11 mounted to the E3C-LD11.
		Area (variable)	<b>E3C-LD31 2M</b>	This model number is for the set consisting of the E39-P21 mounted to the E3C-LD11.
Coaxial Retro-reflective		Spot (variable)	<b>E3C-LR11* 2M</b>	Mounting a Beam Unit (order separately) enables the use of line and area beams.
		Spot (2.0-mm fixed dia.)	<b>E3C-LR12* 2M</b>	---

\* Select a Reflector (order separately) according to the application.

### Amplifier Units

#### Pre-wired Amplifier Units (Dimensions → page 14)

Item	Appearance	Functions	Model	
			NPN output	PNP output
Advanced models		Remote setting Counter Differential operation	<b>E3C-LDA21 2M</b>	<b>E3C-LDA51 2M</b>
		Area output Self-diagnosis Differential operation	<b>E3C-LDA11 2M</b>	<b>E3C-LDA41 2M</b>
		ATC (Active Threshold Control)	<b>E3C-LDA11AT 2M</b>	<b>E3C-LDA41AT 2M</b>
		Analog output	<b>E3C-LDA11AN 2M</b>	<b>E3C-LDA41AN 2M</b>

#### Amplifier Units with Wire-saving Connectors (A Wire-saving Connector (sold separately) is required.) (Dimensions → page 15, 16)

Item	Appearance	Functions	Model	
			NPN output	PNP output
Advanced models		Remote setting Counter Differential operation	<b>E3C-LDA7 *</b>	<b>E3C-LDA9 *</b>
		Area output Self-diagnosis Differential operation	<b>E3C-LDA6 *</b>	<b>E3C-LDA8 *</b>
		ATC (Active Threshold Control)	<b>E3C-LDA6AT</b>	<b>E3C-LDA8AT</b>



\* These models allow you to use an E3X-DRT21-S VER.3 Sensor Communications Unit. When using the E3X-DRT21-S VER.3, use an E3X-CN02 Connector without a Cable for the Wire-saving Connector.

#### Amplifier Unit with Connector for Sensor Communications Unit (for EtherCAT and CompoNet) (Dimensions → page 16)

Item	Appearance	Functions	Model	Applicable Sensor Communications Unit
Advanced models		Area output Self-diagnosis Differential operation	<b>E3C-LDA0</b>	E3X-ECT E3X-CRT

### Accessories (Order Separately)

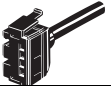
#### Wire-saving connectors (Required for models for Wire-saving Connectors.) \*Protective stickers: provided. (Dimensions → E3X-DA-S/MDA)

Item	Appearance	Cable length	No. of conductors	Model
Master Connector		2 m	4	<b>E3X-CN21</b>
Slave Connector			2	<b>E3X-CN22</b>

#### Ordering Precaution for Amplifier Units with Wire-saving Connectors





Amplifier Units and Connectors are sold separately. Refer to the following tables when placing an order.

Model	Amplifier Unit		+	Applicable Connector (order separately)	
	NPN output	PNP output		Master Connector	Slave Connector
Advanced models	E3C-LDA6	E3C-LDA8	+	E3X-CN21	E3X-CN22
	E3C-LDA7	E3C-LDA9			
	E3C-LDA6AT	E3C-LDA8AT			

#### When Using 5 Amplifier Units

5 Amplifier Units	+	1 Master Connector	4 Slave Connectors
-------------------	---	--------------------	--------------------



## Mobile Console (Dimensions → E3X-DA-S/MDA)

Appearance	Model	Remarks
	<b>E3X-MC11-SV2</b> (model number of set)	Mobile Console with Head, Cable, and AC adapter provided as accessories
	<b>E3X-MC11-C1-SV2</b>	Mobile Console
	<b>E3X-MC11-H1</b>	Head
	<b>E39-Z12-1</b>	Cable (1.5 m)

**Note:** Use the E3X-MC11-S Mobile Console for the E3X-LDA Series Amplifier Units. The E3X-MC11-SV2 is an upgraded version of the E3X-MC11-S that is fully interchangeable with the older model. Refer to **E3X-DA-S/MDA** for details.

## Beam Unit (for E3C-LD11/LR11)

A Beam Unit is not provided with the Sensor and must be ordered separately as required.

Applicable Sensor Head	Appearance	Beam shape	Model
E3C-LD11		Line	<b>E39-P11</b>
		Area	<b>E39-P21</b>
E3C-LR11		Line	<b>E39-P31</b>
		Area	<b>E39-P41</b>

## Mounting Bracket

A Mounting Bracket is not provided with the Amplifier Unit and must be ordered separately as required.

(Dimensions → E39-L/E39-S/E39-R)

Appearance	Model	Quantity
	<b>E39-L143</b>	1

## End Plate

A End Plate is not provided with the Amplifier Unit and must be ordered separately as required.



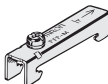

(Dimensions → PFP-□)

Appearance	Model	Quantity
	<b>PFP-M</b>	1

## Reflectors (Required when using retro-reflective models)

A Reflector is not provided with the Sensor head. Be sure to order a Reflector separately.

(Dimensions → E39-L/E39-S/E39-R)

Type	Appearance	Model
Standard Effective area: 23 × 23 mm *		<b>E39-R12</b>
Standard Effective area: 7 × 7 mm *		<b>E39-R13</b>
Transparent object detection Effective area: 23 × 23 mm *		<b>E39-R14</b>
Sheet (cuttable) Effective area: 195 × 22 mm		<b>E39-RS4</b>
Sheet (cuttable) Effective area: 108 × 46 mm		<b>E39-RS5</b>

**Note:** For details, refer to **Reflectors** → E39-L/E39-S/E39-R

\* Use a standard model (E39-R12/R13) if the distance from the Sensor is 400 mm or more. Use the short-distance model (E39-R14) if the distance is less than 400 mm.

## Ratings and Specifications

For dimensions, refer to pages 12 to 16.

## Sensor Heads

Type		Diffuse-reflective			Coaxial Retro-reflective (with M.S.R. function)			
Item	Model	E3C-LD11	E3C-LD21	E3C-LD31	E3C-LR11	E3C-LR11+ E39-P31	E3C-LR11+ E39-P41	E3C-LR12
<b>Light source (wavelength)</b>	Red semiconductor laser diode (650 nm), 3 mW max. (JIS Class 2, IEC/EN Class 2, and FDA Class 2)				Red semiconductor laser diode (650 nm), 3 mW max. (JIS Class 2, IEC/EN Class 2, and FDA Class 2)			1 mW max. (JIS Class 1, IEC/EN Class 1, and FDA Class 2)
<b>Sensing distance</b>	High-resolution mode: 30 to 1,000 mm Standard mode: 30 to 700 mm Super-high-speed mode: 30 to 250 mm *1				7 m 5 m 2 m *2	1,700 mm 1,300 mm 700 mm *2	900 mm 700 mm 400 mm *2	7 m 5 m 2 m *2
<b>Focus *3</b>	0.8 mm max. (at distances up to 300 mm)	33 mm (at 150 mm)	33 × 15 mm (at 150 mm)		0.8 mm max. (at distances up to 1,000 mm)	28 mm (at 150 mm)	28 × 16 mm (at 150 mm)	2.0-mm dia. (at distance up to 1,000 mm)
<b>Functions</b>	Variable focal point mechanism (focus adjustment) *4, optical axis adjustment mechanism (axis adjustment)							
<b>Indicators</b>	LDON indicator: Green; Operation indicator: Orange							
<b>Ambient illumination (Receiver side)</b>	Incandescent lamp: 3,000 lx							
<b>Ambient temperature</b>	Operating: -10 to 55°C, Storage: -25 to 70°C (with no icing or condensation)							
<b>Ambient humidity</b>	Operating/storage: 35% to 85% (with no condensation)							
<b>Insulation resistance</b>	20 MΩ min. at 500 VDC							
<b>Dielectric strength</b>	1,000 VAC at 50/60 Hz for 1 minute							
<b>Shock resistance</b>	Destruction: 300 m/s <sup>2</sup> 6 directions 3 times each (up/down, right/left, forward/backward)							
<b>Vibration resistance</b>	Destruction: 10 to 150 Hz with double amplitude of 0.7 mm, in X, Y, and Z directions for 80 min each							
<b>Degree of protection</b>	IP40 (IEC)				IP40 (IEC 60529)			
<b>Connection method</b>	Connector (standard cable length: 2 m)							
<b>Materials</b>	Case and cover: ABS Front surface filter: Methacrylic resin				Case and cover: ABS Front surface filter: Glass			
<b>Weight (packed state)</b>	Approx. 85 g				Approx. 100 g			
<b>Accessories</b>	Instruction manual, Laser warning labels (English)							

\*1. Sensing distance values are for white paper.

\*2. These sensing distance values apply when a E39-R12 Reflector is used. The MSR function is built-in. The reflected light from the object being measured may affect the sensing accuracy, so adjust the threshold value before use.

\*3. The beam radius is the value for the middle measurement distance and indicates a typical value for the middle sensing distance. The radius is defined by light intensity of 1/e<sup>2</sup> (13.5%) of the central light intensity.

Light will extend beyond the main beam and may be affected by conditions surrounding the object being measured.

\*4. The E3C-LR12 has a fixed beam size (the focal point cannot be changed).

## Amplifier Units

Type		External-input models		Twin-output models			ATC-output models		Analog-output models	
		Standard models		Standard models		Model for Sensor Communications Unit	Standard models		Standard models	
		Pre-wired	Wire-saving connector	Pre-wired	Wire-saving connector		Pre-wired	Wire-saving connector	Pre-wired	
Model	NPN output	E3C-LDA21	E3C-LDA7	E3C-LDA11	E3C-LDA6	E3C-LDA0 *1	E3C-LDA11AT	E3C-LDA6AT	E3C-LDA11AN	
	PNP output	E3C-LDA51	E3C-LDA9	E3C-LDA41	E3C-LDA8		E3C-LDA41AT	E3C-LDA8AT	E3C-LDA41AN	
Item		Supply voltage								
		12 to 24 VDC $\pm$ 10%, ripple (p-p) 10% max.								
		Power consumption								
		1,080 mW max. (current consumption: 45 mA max. at power supply voltage of 24 VDC)								
Control output	ON/OFF output	Load power supply voltage: 26.4 VDC max.; NPN/PNP (depends on model) open collector Load current: 50 mA max.; residual voltage: 1 V max.								
	Analog output	---							Control output Voltage output: 1 to 5 VDC (connected load 10 k $\Omega$ min.) Temperature characteristics 0.3% F.S./ $^{\circ}$ C Response time/ Repeat accuracy Super-high-speed mode: 100 $\mu$ s/4.0% F.S. High-speed mode: 250 $\mu$ s/4.0% F.S. Standard mode: 1 ms/2.0% F.S. High-resolution mode: 4 ms/2.0% F.S.	
Response time	Super-highspeed mode *2	80 $\mu$ s for operation and reset	100 $\mu$ s for operation and reset	---	100 $\mu$ s for operation and reset					
	High-speed mode	250 $\mu$ s for operation and reset								
	Standard mode	1 ms for operation and reset								
	High-resolution mode	4 ms for operation and reset								
Functions	Differential detection	Switchable between single edge and double edge detection mode. Single edge: Can be set to 250 $\mu$ s, 500 $\mu$ s, 1 ms, 10 ms, or 100 ms. Double edge: Can be set to 500 $\mu$ s, 1 ms, 2 ms, 20 ms, or 200 ms.							---	
	Timer function	Select from OFF-delay, ON-delay, or one-shot timer. 1 ms to 5 s (1 to 20 ms set in 1-ms increments, 20 to 200 ms set in 10-ms increments, 200 ms to 1 s set in 100-ms increments, and 1 to 5 s set in 1-s increments)								
	Zero-reset	Negative values can be displayed.								
	Initial reset	Settings can be returned to defaults as required.								
	Mutual interference prevention	Possible for up to 10 Units. *2								
	Counter	Switchable between up counter and down counter. Set count: 0 to 9,999,999		---						
I/O settings	External input setting (Select from teaching, power tuning, zero reset, light OFF, or counter reset.)		Output setting (Select from channel 2 output, area output, or self-diagnosis.)			Output setting (Select from channel 2 output, area output, self-diagnosis, or ATC error output.)		Analog output setting (Offset voltage can be adjusted.)		
Digital display	Select from digital incident level + threshold or six other patterns.									
Display orientation	Switching between normal/reversed display is possible.									
Ambient temperature range *3	Operating: Groups of 1 to 2 Amplifiers: $-25^{\circ}$ C to $55^{\circ}$ C, Groups of 3 to 10 Amplifiers: $-25^{\circ}$ C to $50^{\circ}$ C, Groups of 11 to 16 Amplifiers: $-25^{\circ}$ C to $45^{\circ}$ C Storage: $-30^{\circ}$ C to $70^{\circ}$ C (with no icing)									
Ambient humidity range	Operating and storage: 35% to 85% (with no condensation)									
Insulation resistance	20 M $\Omega$ at 500 VDC									
Dielectric strength	1,000 VAC at 50/60 Hz for 1 min.									
Vibration resistance *4	Destruction: 10 to 55 Hz with a 1.5-mm double amplitude for 2 hours each in X, Y, and Z directions									
Shock resistance *5	Destruction: 500 m/s $^2$ , 3 times each in X, Y, and Z directions									
Degree of protection	IP50 (IEC 60529)									
Connection method	Pre-wired or wire-saving connector *6									
Weight (packed state)	Pre-wired Models: Approx. 100 g Wire-saving Connector Models: Approx. 55 g Sensor Communications Unit Connector Models: Approx. 55 g									
Materials	Case	Polybutylene terephthalate (PBT)								
	Cover	Polycarbonate								

\*1. This model allows you to use an E3X-ECT EtherCAT Sensor Communications Unit or E3X-CRT CompoNet Sensor Communications Unit.

\*2. Communications are disabled if super-high-speed mode is selected, and the mutual interference prevention function and the communications function for the Mobile Console will not function.

\*3. The following temperature ranges apply when an E3X-ECT EtherCAT or E3X-CRT CompoNet Sensor Communications Unit is used with the E3C-LDA0: Groups of 1 or 2 Amplifier Units: 0 to  $55^{\circ}$ C, Groups of 3 to 10 Amplifier Units: 0 to  $50^{\circ}$ C, Groups of 11 to 16 Amplifier Units: 0 to  $45^{\circ}$ C, Groups of 17 to 30 Amplifier Units (with the E3X-ECT): 0 to  $40^{\circ}$ C.

\*4. The vibration resistance of the E3C-LDA0 is as follows: Destruction: 10 to 150 Hz with a 0.7-mm double amplitude for 80 min each in X, Y, and Z directions.

\*5. The shock resistance of the E3C-LDA0 is as follows: Destruction: 150 m/s $^2$ , 3 times each in X, Y, and Z directions.

\*6. A connector for a Sensor Communications Unit is used to connect the E3C-LDA0.

# Engineering Data (Reference Value)

## Minimum Beam Diameter vs. Sensing Distance

E3C-LD11

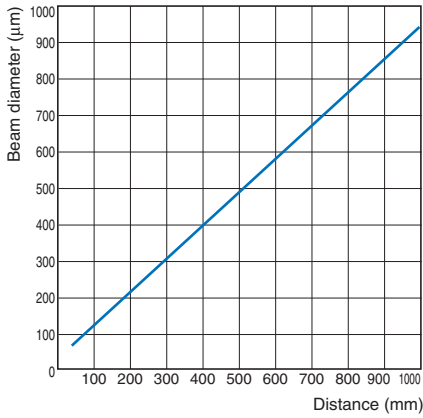

E3C-LR11

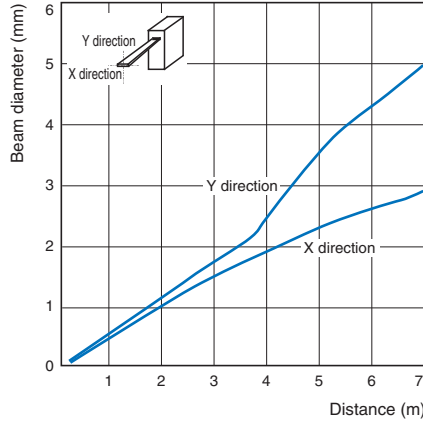

E3C-LR12

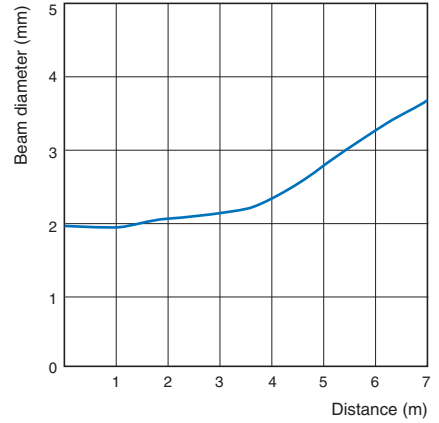

## Beam Shape vs. Sensing Distance

E3C-LD21

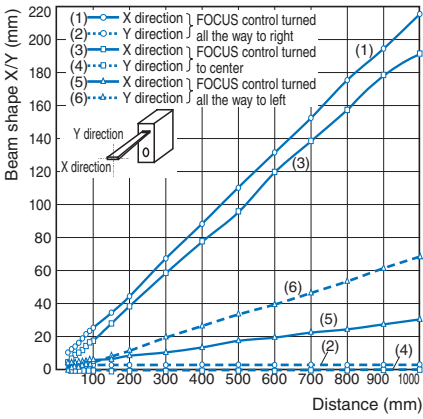

E3C-LD31

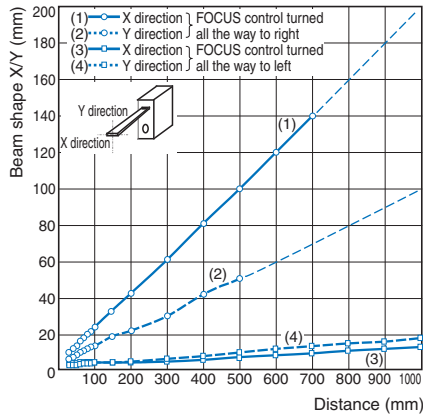

**Note:** The dashed lines indicate non-visible regions of the beam shape.

## Differential Travel vs. Sensing Distance

E3C-LD

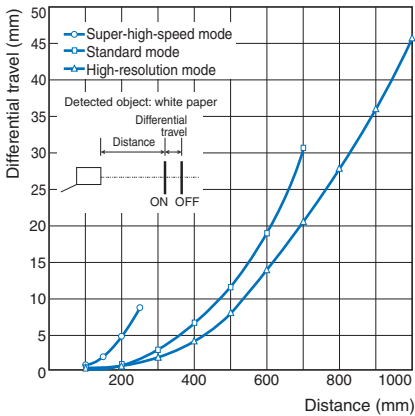

# I/O Circuit Diagrams

## NPN Output

Model	Operation mode	Timing charts	Mode selector switch	Output circuit
E3C-LDA11 E3C-LDA6 E3C-LDA11AT E3C-LDA6AT	Light-ON	ch1/ Incident light  No incident light ch2/ Incident light  No incident light Operation Indicator (orange) ON  OFF Output transistor ON  OFF Load Operate (e.g., relay)  Reset (Between brown and black leads)	L-ON (LIGHT ON)	
	Dark-ON	ch1/ Incident light  No incident light ch2/ Incident light  No incident light Operation Indicator (orange) ON  OFF Output transistor ON  OFF Load Operate (e.g., relay)  Reset (Between brown and black leads)	D-ON (DARK ON)	
E3C-LDA21 E3C-LDA7	Light-ON	Incident light  No incident light Operation Indicator (orange) ON  OFF Output transistor ON  OFF Load Operate (e.g., relay)  Reset (Between brown and black leads)	L-ON (LIGHT ON)	
	Dark-ON	Incident light  No incident light Operation Indicator (orange) ON  OFF Output transistor ON  OFF Load Operate (e.g., relay)  Reset (Between brown and black leads)	D-ON (DARK ON)	
E3C-LDA11AN	Light-ON	Incident light  No incident light Operation Indicator (orange) ON  OFF Output transistor ON  OFF Load Operate (e.g., relay)  Reset (Between brown and black leads)	L-ON (LIGHT ON)	
	Dark-ON	Incident light  No incident light Operation Indicator (orange) ON  OFF Output transistor ON  OFF Load Operate (e.g., relay)  Reset (Between brown and black leads)	D-ON (DARK ON)	

PNP Output

Model	Operation mode	Timing charts	Mode selector switch	Output circuit
E3C-LDA41 E3C-LDA8 E3C-LDA41AT E3C-LDA8AT	Light-ON	ch1/ Incident light ch2 No incident light Operation ON Indicator (orange) OFF Output transistor ON Load Operate (e.g., relay) Reset (Between blue and black leads)	L-ON (LIGHT ON)	
	Dark-ON	ch1/ Incident light ch2 No incident light Operation ON Indicator (orange) OFF Output transistor ON Load Operate (e.g., relay) Reset (Between blue and black leads)	D-ON (DARK ON)	
E3C-LDA51 E3C-LDA9	Light-ON	Incident light No incident light Operation ON Indicator (orange) OFF Output transistor ON Load Operate (e.g., relay) Reset (Between blue and black leads)	L-ON (LIGHT ON)	
	Dark-ON	Incident light No incident light Operation ON Indicator (orange) OFF Output transistor ON Load Operate (e.g., relay) Reset (Between blue and black leads)	D-ON (DARK ON)	
E3C-LDA41AN	Light-ON	Incident light No incident light Operation ON Indicator (orange) OFF Output transistor ON Load Operate (e.g., relay) Reset (Between blue and black leads)	L-ON (LIGHT ON)	
	Dark-ON	Incident light No incident light Operation ON Indicator (orange) OFF Output transistor ON Load Operate (e.g., relay) Reset (Between blue and black leads)	D-ON (DARK ON)	



## Nomenclature

### Amplifier Units

#### Twin Output Models

(E3C-LDA11/LDA41/LDA6/LDA8/LDA0)

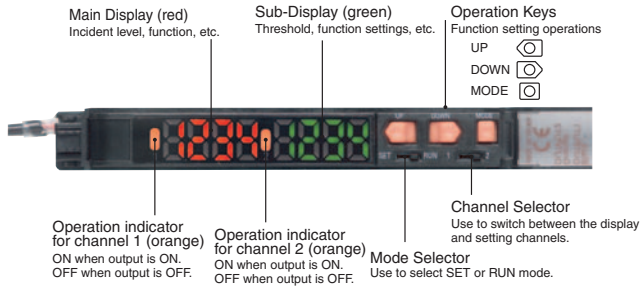

#### External Input Models

(E3C-LDA21/LDA51/LDA7/LDA9)

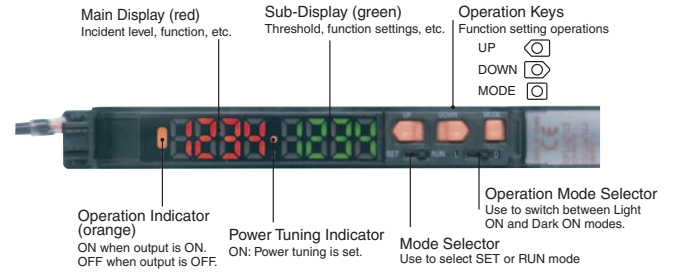

## Safety Precautions

Refer to the *Photoelectric Sensors Technical Guide*.

### WARNING

This product is not designed or rated for ensuring safety of persons either directly or indirectly. Do not use it for such purpose.



Never look into the laser beam.

Doing so continuously will result in visual impairment.



### Precautions for Safe Use

The following rules are required to ensure safety. Be sure to observe these rules.

- Installation environment
  - Do not use in an environment where combustible or explosive gas is present.
  - To ensure safe operation and maintenance of the product, install it away from high-voltage devices and power devices.
- Power supply and wiring
  - Do not exceed the rated voltage (12 to 24 VDC  $\pm$ 10%).
  - Do not remove a connector while it is supplying power. This may damage the product.
- Other points
  - Do not attempt to disassemble, repair, or modify the product.
  - When disposing of the product, treat it as industrial waste.

## Precautions for Correct Use

Do not use the product in atmospheres or environments that exceed product ratings.

Official laser safety measures have been established regarding laser devices both inside and outside of Japan. For details, refer to *Laser Beam Safety Standards*.

## Amplifier Units

### ●Designing

#### Operation after Turning Power ON

The Amplifier Unit is ready to operate within 200 ms after the power supply is turned ON. If the Sensor and load are connected to power supplies separately, be sure to turn ON the power supply to the Sensor first.

### Cleaning

Do not use thinner, benzene, acetone, or kerosene. If the filter on the front of the sensor becomes soiled with dust, oil droplets, or other materials,

- Use a blower brush (used to clean camera lenses) to blow large dust particles from the surface. Do not blow the dust away with your mouth.
- Use a soft cloth (for cleaning lenses) with a little alcohol to remove the remaining dust.

**Note:** Do not use a scrubbing action when cleaning as a scratch on the filter could result in the Sensor malfunctioning.

### About the object

Measurement may not be possible or may not be precise with some types of object materials and shapes (such as transparent objects, objects with extremely low reflectance, objects smaller than the beam diameter, objects with a large curvature, highly tilted objects, etc).

## ●Mounting

### Mounting and removing the sensor head

- Open the protective cover.
- With the locking lever on the sensor head connector facing up, insert the connector into the connector opening.

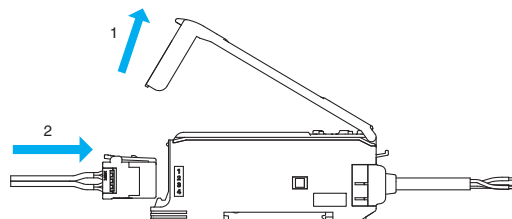

To remove the connector, press down on the locking lever and pull the connector out.

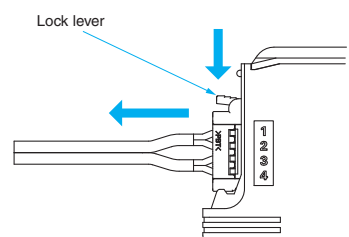

### Connecting and Disconnecting Connectors

#### (Mounting Connectors)

- Insert the Master or Slave Connector into the Amplifier Unit until it clicks into place.

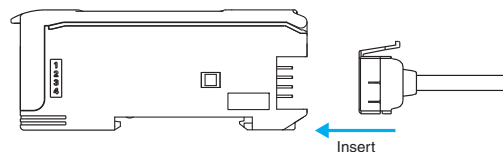

- Attach the protector seals (provided as accessories) to the sides of master and slave connectors that are not connected.

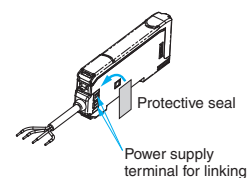

**Note:** Attach the seals to the sides with grooves.

#### (Removing Connectors)

- Slide the slave Amplifier Unit(s) for which the Connector is to be removed away from the rest of the group.
- After the Amplifier Unit(s) has been separated, press down on the lever on the Connector and remove it. (Do not attempt to remove Connectors without separating them from other Amplifier Units first.)

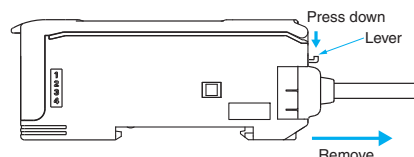

## Mounting and Removing Amplifier Units

### (Mounting Amplifier Units)

1. Mount the Amplifier Units one at a time onto the DIN track.

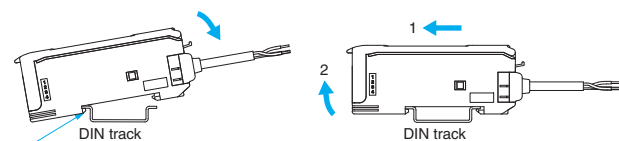

Sensor head connector catches

2. Slide the Amplifier Units together, line up the clips, and press the Amplifier Units together until they click into place.

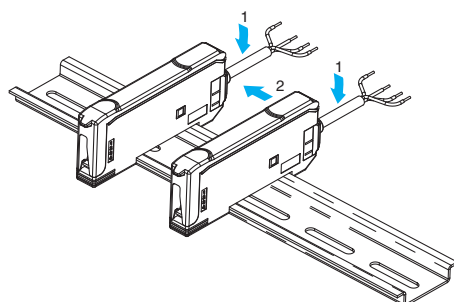

### (Separating Amplifier Units)

Slide Amplifier Units away from each other, and remove from the DIN track one at a time. (Do not attempt to remove Amplifier Units from the DIN track without separating them first.)

**Note:** 1. The specifications for ambient temperature will vary according to the number of Amplifier Units used together. For details, refer to **Ratings and Specifications** on page 5.  
2. Always turn OFF the power supply before mounting or separating Amplifier Units.

### Mounting the End Plate (PFP-M)

An End Plate should be used if there is a possibility of the Amplifier Unit moving, e.g., due to vibration. If a Mobile Console is going to be mounted, connect the End Plate in the direction shown in the following diagram.

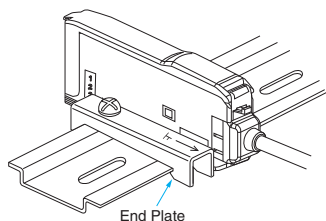

End Plate

### Mounting the Mobile Console Head

Leave a gap of at least 20 mm between the nearest Amplifier Unit and the Mobile Console head.

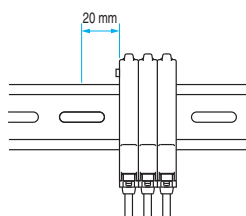

## ●Adjustments

### Mutual Interference Protection Function

There may be some instability in the digital display values due to light from other sensors. If this occurs, decrease the sensitivity (i.e., decrease the power or increase the threshold) to perform stable detection.

## Beam shape adjustment function

The shape of the beam at each sensing distance can be adjusted by turning the beam shape control.

### (E3C-LD11/-LR11)

Turn the control to the left to adjust the focal position to short distance detection. Turn the control to the right to adjust the focal position to long distance detection.

### (E3C-LD21)

Turn the control to the left to decrease the beam width. Turn the control to the right to increase the beam width.

### (E3C-LD31)

Turn the control to the left to decrease the beam area. Turn the control to the right to increase the beam area.

Do not turn the beam shape control to more than 60 mN·m. Otherwise, this may damage the unit.

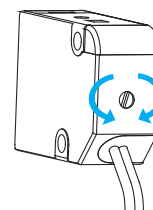

Do not turn the beam shape control to more than 60 mN·m. This may damage the unit.

## Optical axis alignment function

The angle of beam projection can be adjusted by turning the optical axis alignment control.

Turning the control about 45° to the right will move the optical axis to the left by the number of degrees shown below.

Turning the control about 45° to the left will move the optical axis to the right by the number of degrees shown below.

If the act of adjusting the optical axis changes the beam shape, adjust the beam shape again. Turning the control 180° will return the optical axis to its original position.

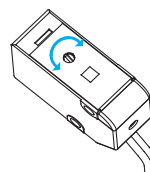

Adjustment angle

E3C-LR11 : Approx. 1.5°  
E3C-LR12 : Approx. 1.0°  
E3C-LD□□ : Approx. 2.0°

## EEPROM Writing Error

If the data is not written to the EEPROM correctly due to a power failure or static-electric noise, initialize the settings with the keys on the Amplifier Unit. ERR/EEP will flash on the display when a writing error has occurred.

## Optical Communications

Several Amplifier Units can be slid together and used in groups. Do not, however, slide the Amplifier Units or attempt to remove any of the Amplifier Units during operation.

## ●Other Precautions

### Protective Cover

Always keep the protective cover in place when using the Amplifier Unit.

### Mobile Console

Use the E3X-MC11-C1-SV2 Mobile Console for the E3C-LDA-series Amplifier Units.



E3C-LR11/LR12

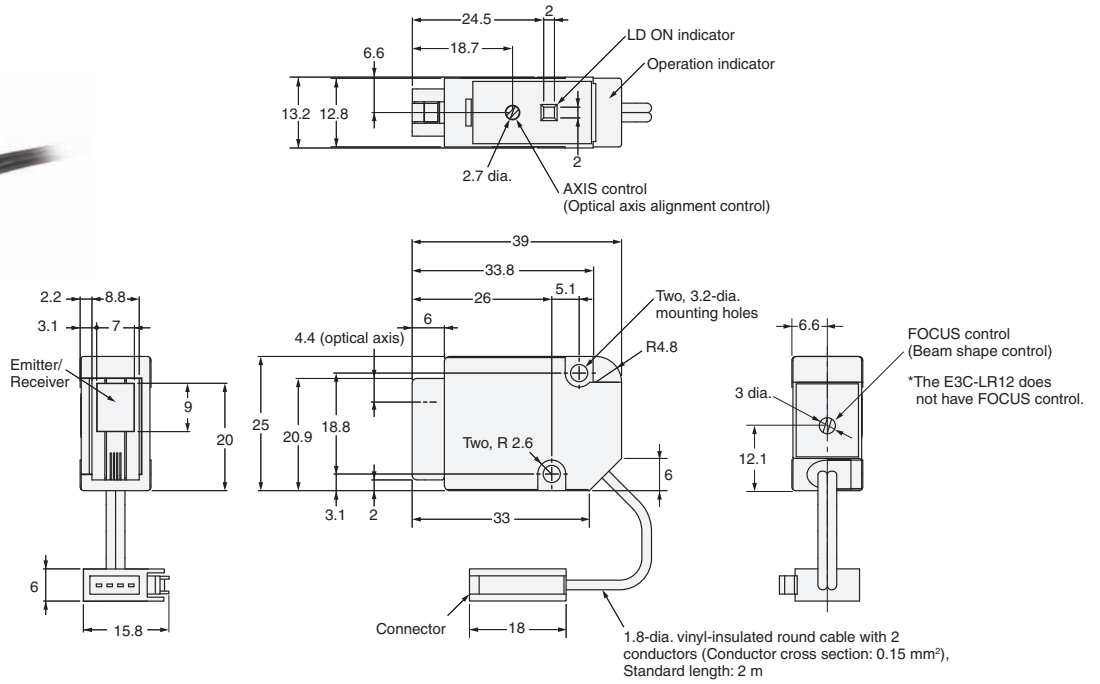

# Amplifier Units

## Pre-wired Amplifier Units

- E3C-LDA11
- E3C-LDA21
- E3C-LDA41
- E3C-LDA51
- E3C-LDA11AT
- E3C-LDA41AT
- E3C-LDA11AN
- E3C-LDA41AN

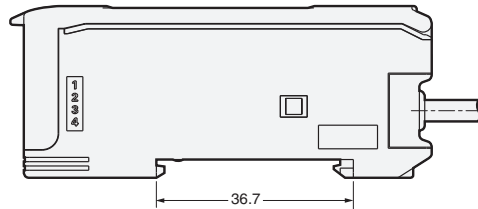
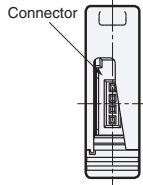
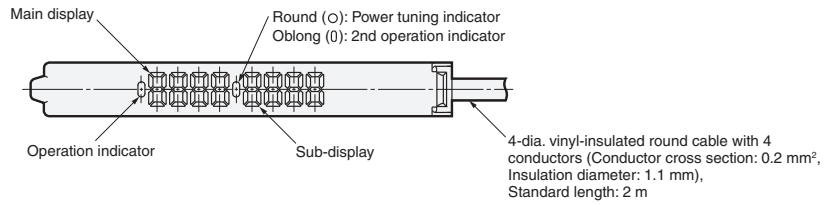

### With Mounting Bracket Attached

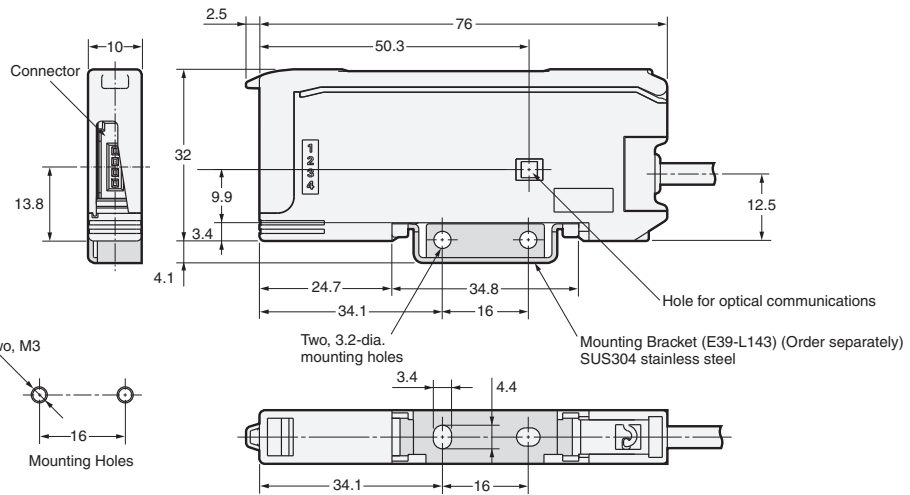
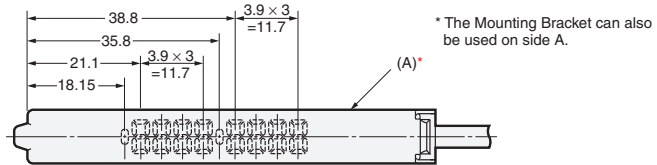

Amplifier Units with Wire-saving Connectors

- E3C-LDA6
- E3C-LDA7
- E3C-LDA8
- E3C-LDA9
- E3C-LDA6AT
- E3C-LDA8AT

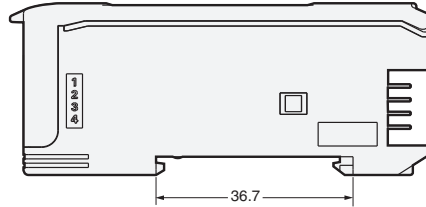
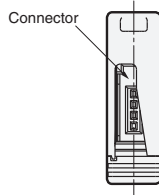
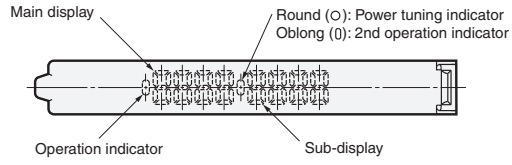

With Mounting Bracket Attached

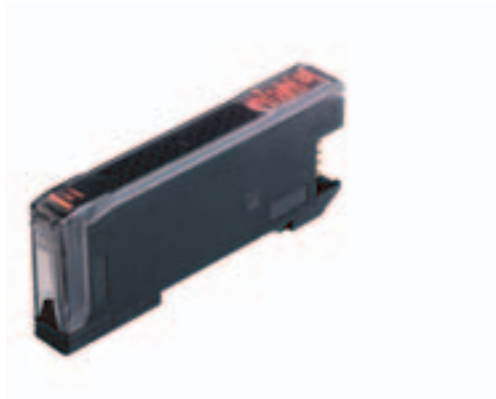
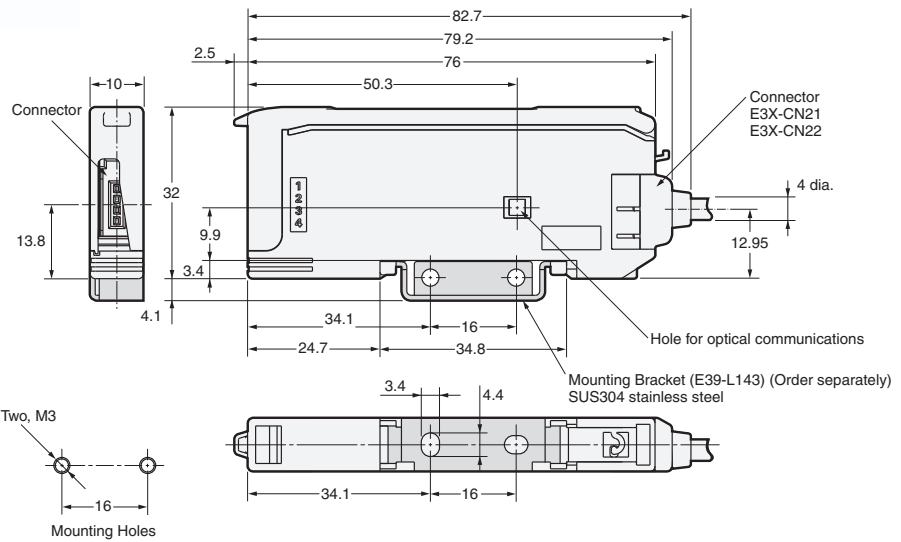
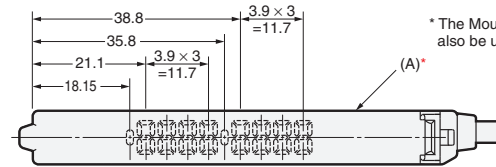

**Amplifier Units with Wire-saving Connectors**

- E3C-LDA6
- E3C-LDA7
- E3C-LDA8
- E3C-LDA9
- E3C-LDA6AT
- E3C-LDA8AT

\* Cable diameters are as follows:  
 E3X-CN12 2.6 dia.  
 E3X-CN22 4.0 dia.

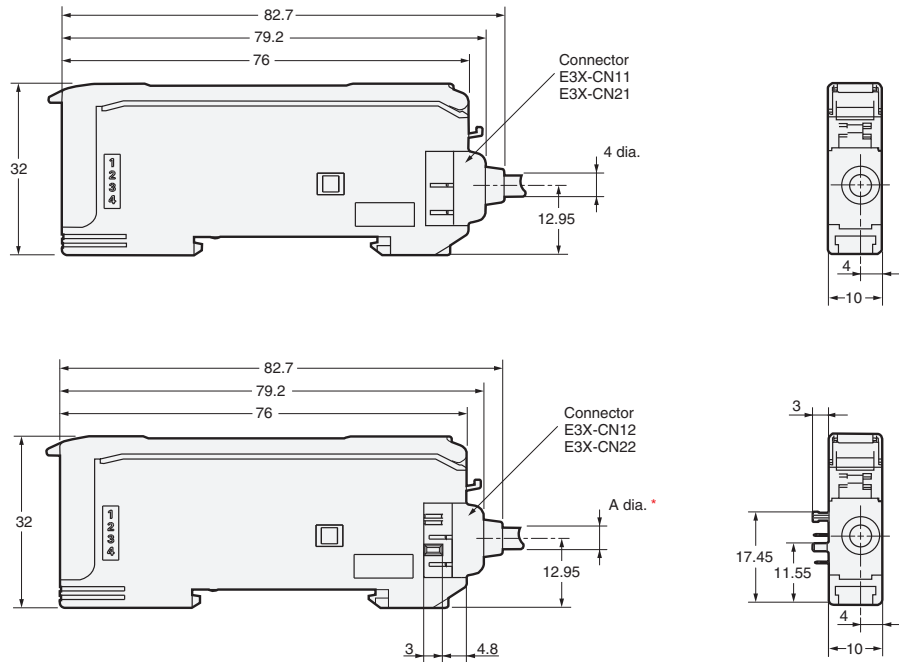

**Amplifier Unit with Connector for Sensor Communications Unit**

E3C-LDA0

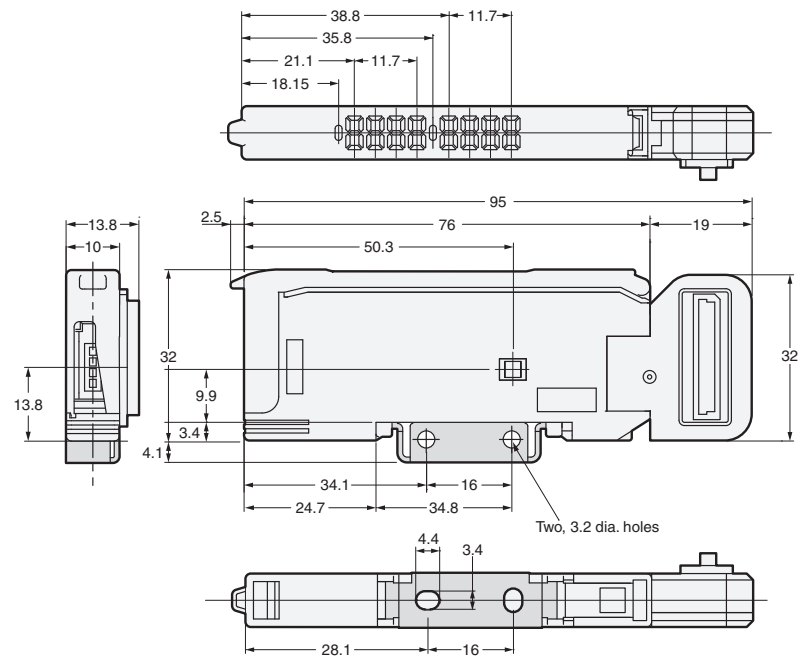

**Accessories (Order Separately)**

**Reflectors**

Refer to E39-S/E39-R for details.

**Mounting Bracket**

Refer to E39-L for details.

**End Plate**

Refer to DIN rail for details.

**Wire-saving connector**

Refer to E3X-DA-S/MDA for details.

**Mobile Console**

Refer to E3X-DA-S/MDA for details.



## Terms and Conditions Agreement

### Read and understand this catalog.

Please read and understand this catalog before purchasing the products. Please consult your OMRON representative if you have any questions or comments.

### Warranties.

(a) Exclusive Warranty. Omron's exclusive warranty is that the Products will be free from defects in materials and workmanship for a period of twelve months from the date of sale by Omron (or such other period expressed in writing by Omron). Omron disclaims all other warranties, express or implied.

(b) Limitations. OMRON MAKES NO WARRANTY OR REPRESENTATION, EXPRESS OR IMPLIED, ABOUT NON-INFRINGEMENT, MERCHANTABILITY OR FITNESS FOR A PARTICULAR PURPOSE OF THE PRODUCTS. BUYER ACKNOWLEDGES THAT IT ALONE HAS DETERMINED THAT THE PRODUCTS WILL SUITABLY MEET THE REQUIREMENTS OF THEIR INTENDED USE.

Omron further disclaims all warranties and responsibility of any type for claims or expenses based on infringement by the Products or otherwise of any intellectual property right. (c) Buyer Remedy. Omron's sole obligation hereunder shall be, at Omron's election, to (i) replace (in the form originally shipped with Buyer responsible for labor charges for removal or replacement thereof) the non-complying Product, (ii) repair the non-complying Product, or (iii) repay or credit Buyer an amount equal to the purchase price of the non-complying Product; provided that in no event shall Omron be responsible for warranty, repair, indemnity or any other claims or expenses regarding the Products unless Omron's analysis confirms that the Products were properly handled, stored, installed and maintained and not subject to contamination, abuse, misuse or inappropriate modification. Return of any Products by Buyer must be approved in writing by Omron before shipment. Omron Companies shall not be liable for the suitability or unsuitability or the results from the use of Products in combination with any electrical or electronic components, circuits, system assemblies or any other materials or substances or environments. Any advice, recommendations or information given orally or in writing, are not to be construed as an amendment or addition to the above warranty.

See <http://www.omron.com/global/> or contact your Omron representative for published information.

### Limitation on Liability; Etc.

OMRON COMPANIES SHALL NOT BE LIABLE FOR SPECIAL, INDIRECT, INCIDENTAL, OR CONSEQUENTIAL DAMAGES, LOSS OF PROFITS OR PRODUCTION OR COMMERCIAL LOSS IN ANY WAY CONNECTED WITH THE PRODUCTS, WHETHER SUCH CLAIM IS BASED IN CONTRACT, WARRANTY, NEGLIGENCE OR STRICT LIABILITY.

Further, in no event shall liability of Omron Companies exceed the individual price of the Product on which liability is asserted.

### Suitability of Use.

Omron Companies shall not be responsible for conformity with any standards, codes or regulations which apply to the combination of the Product in the Buyer's application or use of the Product. At Buyer's request, Omron will provide applicable third party certification documents identifying ratings and limitations of use which apply to the Product. This information by itself is not sufficient for a complete determination of the suitability of the Product in combination with the end product, machine, system, or other application or use. Buyer shall be solely responsible for determining appropriateness of the particular Product with respect to Buyer's application, product or system. Buyer shall take application responsibility in all cases.

NEVER USE THE PRODUCT FOR AN APPLICATION INVOLVING SERIOUS RISK TO LIFE OR PROPERTY OR IN LARGE QUANTITIES WITHOUT ENSURING THAT THE SYSTEM AS A WHOLE HAS BEEN DESIGNED TO ADDRESS THE RISKS, AND THAT THE OMRON PRODUCT(S) IS PROPERLY RATED AND INSTALLED FOR THE INTENDED USE WITHIN THE OVERALL EQUIPMENT OR SYSTEM.

### Programmable Products.

Omron Companies shall not be responsible for the user's programming of a programmable Product, or any consequence thereof.

### Performance Data.

Data presented in Omron Company websites, catalogs and other materials is provided as a guide for the user in determining suitability and does not constitute a warranty. It may represent the result of Omron's test conditions, and the user must correlate it to actual application requirements. Actual performance is subject to the Omron's Warranty and Limitations of Liability.

### Change in Specifications.

Product specifications and accessories may be changed at any time based on improvements and other reasons. It is our practice to change part numbers when published ratings or features are changed, or when significant construction changes are made. However, some specifications of the Product may be changed without any notice. When in doubt, special part numbers may be assigned to fix or establish key specifications for your application. Please consult with your Omron's representative at any time to confirm actual specifications of purchased Product.

### Errors and Omissions.

Information presented by Omron Companies has been checked and is believed to be accurate; however, no responsibility is assumed for clerical, typographical or proofreading errors or omissions.

2015.9

In the interest of product improvement, specifications are subject to change without notice.

**OMRON Corporation**  
Industrial Automation Company

<http://www.ia.omron.com/>

(c)Copyright OMRON Corporation 2015 All Right Reserved.

# Mouser Electronics

Authorized Distributor

Click to View Pricing, Inventory, Delivery & Lifecycle Information:

[Omron:](#)

[E3C-LDA9](#) [E3C-LDA7](#) [E3C-LDA6](#) [E3C-LDA8](#) [E3C-LD11-2M](#)

Компания «Life Electronics» занимается поставками электронных компонентов импортного и отечественного производства от производителей и со складов крупных дистрибьюторов Европы, Америки и Азии.

С конца 2013 года компания активно расширяет линейку поставок компонентов по направлению коаксиальный кабель, кварцевые генераторы и конденсаторы (керамические, пленочные, электролитические), за счёт заключения дистрибьюторских договоров

Мы предлагаем:

- Конкурентоспособные цены и скидки постоянным клиентам.
- Специальные условия для постоянных клиентов.
- Подбор аналогов.
- Поставку компонентов в любых объемах, удовлетворяющих вашим потребностям.
- Приемлемые сроки поставки, возможна ускоренная поставка.
- Доставку товара в любую точку России и стран СНГ.
- Комплексную поставку.
- Работу по проектам и поставку образцов.
- Формирование склада под заказчика.
- Сертификаты соответствия на поставляемую продукцию (по желанию клиента).
- Тестирование поставляемой продукции.
- Поставку компонентов, требующих военную и космическую приемку.
- Входной контроль качества.
- Наличие сертификата ISO.

В составе нашей компании организован Конструкторский отдел, призванный помогать разработчикам, и инженерам.

Конструкторский отдел помогает осуществить:

- Регистрацию проекта у производителя компонентов.
- Техническую поддержку проекта.
- Защиту от снятия компонента с производства.
- Оценку стоимости проекта по компонентам.
- Изготовление тестовой платы монтаж и пусконаладочные работы.



Тел: +7 (812) 336 43 04 (многоканальный)

Email: [org@lifeelectronics.ru](mailto:org@lifeelectronics.ru)