

MR25H00-EVAL MRAM Evaluation Board

The MR25H00-EVAL MRAM evaluation board from Everspin is an Arduino-derived MRAM Shield that will interface with any Arduino-derived microcontroller host board with standardized UNO pinout.

The Evaluation Board

The evaluation board is populated with a 4Mbit Everspin MR25H40 SPI MRAM for evaluation of any of the Everspin Product Families listed below.

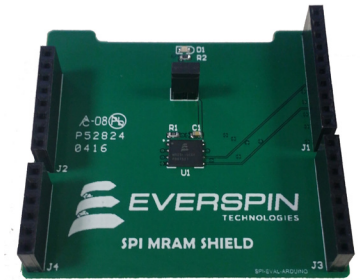

Everspin Product Family	Density	Temperature Grades
MR25H256	256 Kb / 40MHz	Industrial / AEC-Q100 Grade 1
MR25H10	1 Mb / 40MHz	Industrial / AEC-Q100 Grade 1
MR20H40	4Mb / 50MHz	Industrial
MR25H40	4 Mb / 40MHz	Industrial / AEC-Q100 Grade 1

Host Board Support

The MR25H00-EVAL Evaluation board employs a pin out that is compatible with the Arduino form factor UNO pinout. The board utilizes the SPI interface on UNO pins D10, D11, D12, and D13. The HOLD and WP pins are connected to digital pins D8 and D9. See **Appendix A – MR25H00-EVAL Schematic and Layout** for more detail.

By using this common MCU evaluation board pinout, the MR25H00-EVAL board is compatible with a large number of MCU evaluation boards. For example, the following four MCU series listed below with Arduino-derived host boards will work for evaluation using the SPI MRAM Evaluation board.

Host Board Supplier	MCU	Host Board
ST Micro	STM32F411RET6 Series	NUCLEO-F411RE
Freescale	Kinetis MCU Series	Kinetis Freedom
NXP	LCP Series MCU	LPCXpresso
Renesas	ARM Cortex™-A9 processor Series	GR-PEACH: RZ/A1H

We use the NUCLEO-F411RE host board as the example for setup in this Guide.

SETUP: MR10Q010 - EVAL MRAM EVALUATION BOARD

Besides the MCU host board and the Everspin MR25H00-EVAL Evaluation board, you will need:

- Computer with Internet access and USB port.
- A USB cable, with standard A to mini B connectors.
- Everspin example code from www.mbed.org.

Step 1: Download the USB Driver for your MCU Host Board

Host Board	USB Driver
NUCLEO-F411RE	Host Board Description and Drivers
Kinetic Freedom	Host Board Description and Drivers
LPCXpresso	Host Board Description and Drivers
GR-PEACH: RZ/A1H	Host Board Description and Drivers
Other	Host Board home page

Step 2: Plug in the SPI Evaluation board and connect it to your computer via the USB port.

First, plug the MR25H00-EVAL board into your MCU host board, then connect the host board to your PC using the USB cable. The MCU host board will enumerate as a composite USB device that includes a built in debugger, storage device and a virtual com port.

A new drive will be created on your computer with a drive name as assigned by the host board. We are using the NUCLEO-411RE as an example for this Setup description.

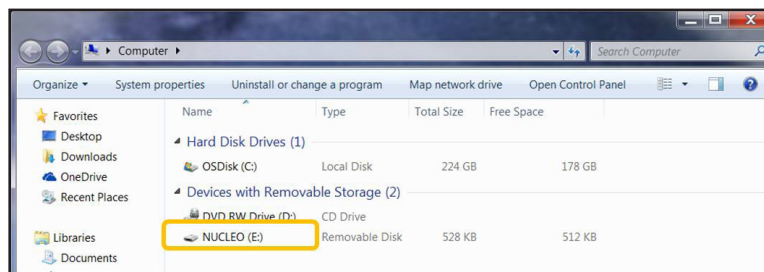

Setup (Continued)

Step 3: Log in to ARM mbed and create a Workspace on your computer.

1. Log in to developer.mbed.org. (If you do not already have an mbed account, you will need to create one.)
2. After logging in, click on the **Compiler** button on the upper right section of the screen.

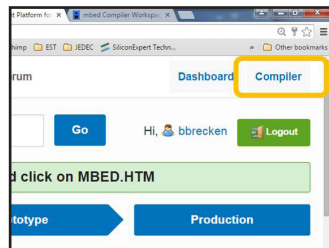

3. The mbed compiler will bring up the **Workspace Management** screen.

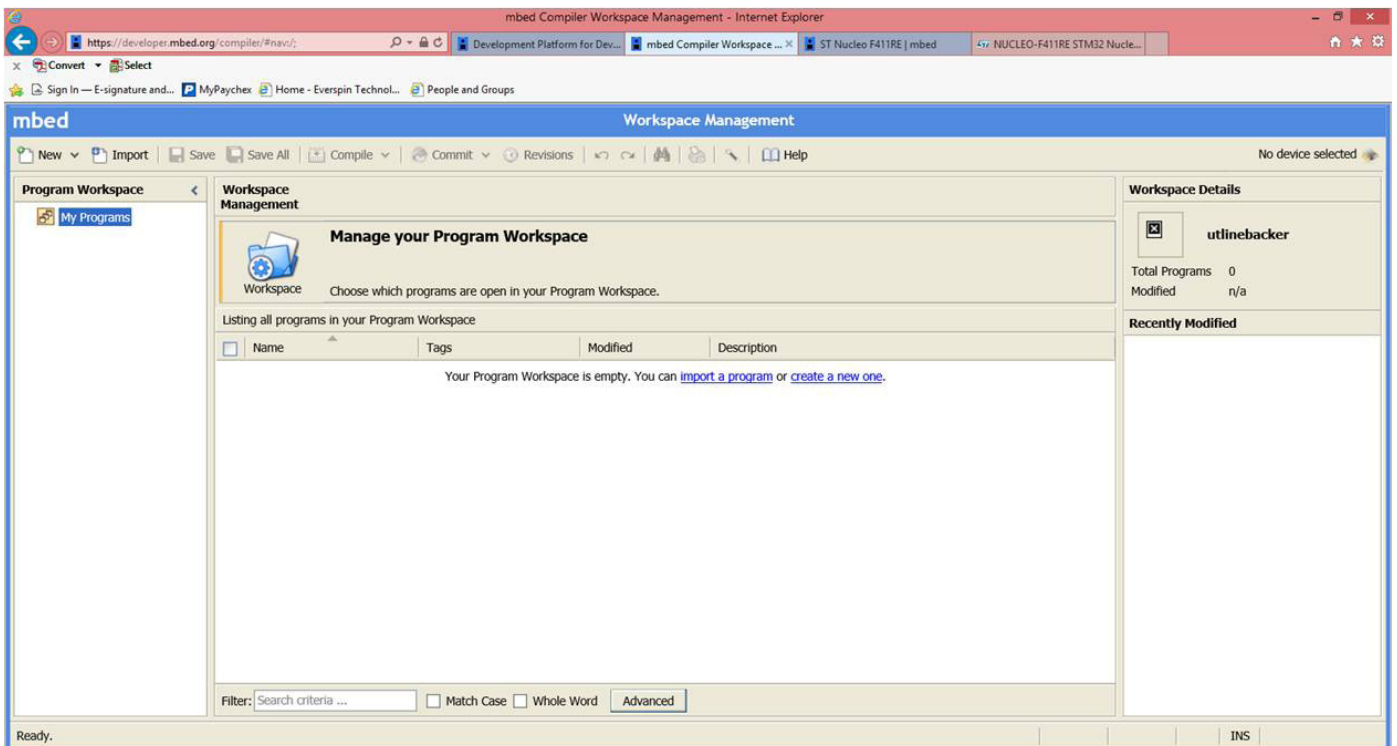

Setup (Continued)

Step 4: Load the platform for the host board you are using

1. The button on the upper right of the Workspace Management screen will read **No device selected** or, if you have previously loaded a platform, the name of the host board for that platform will appear, as in the **NUCLEO-411RE** case shown.

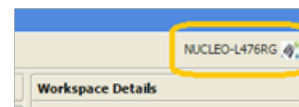
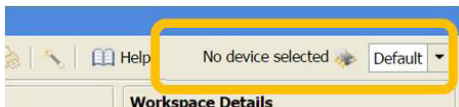

2. In either case, click on the button to open the available compiler platforms screen. Select the host board platform you wish to load or, if it is not present, then select **Add**.

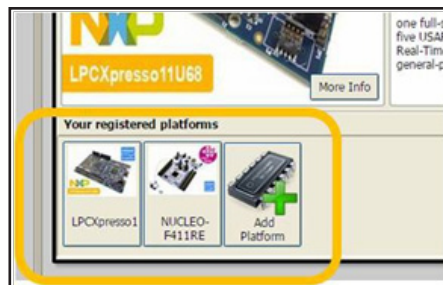

3. **Adding a platform to your Workspace.** If you selected **Add**, mbed will display a scrolling list of available platforms. Find the MCU host board you are using and click on the image.

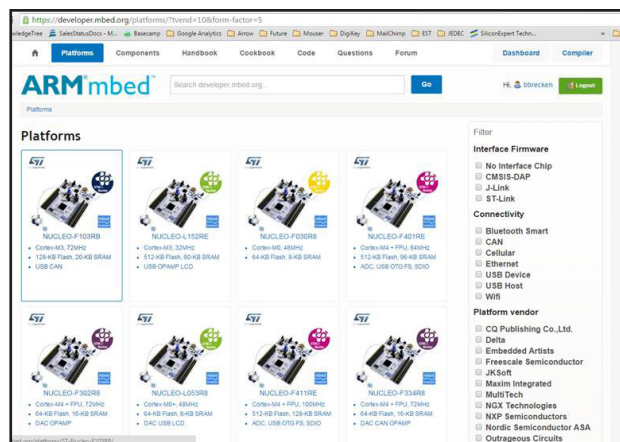

Setup (Continued)

4. **mbed** will open a new window as an information page for that host platform, such as the NUCLEO-411RE example here. To add this platform to your workspace, click on the **Add to your mbed Compiler** button.

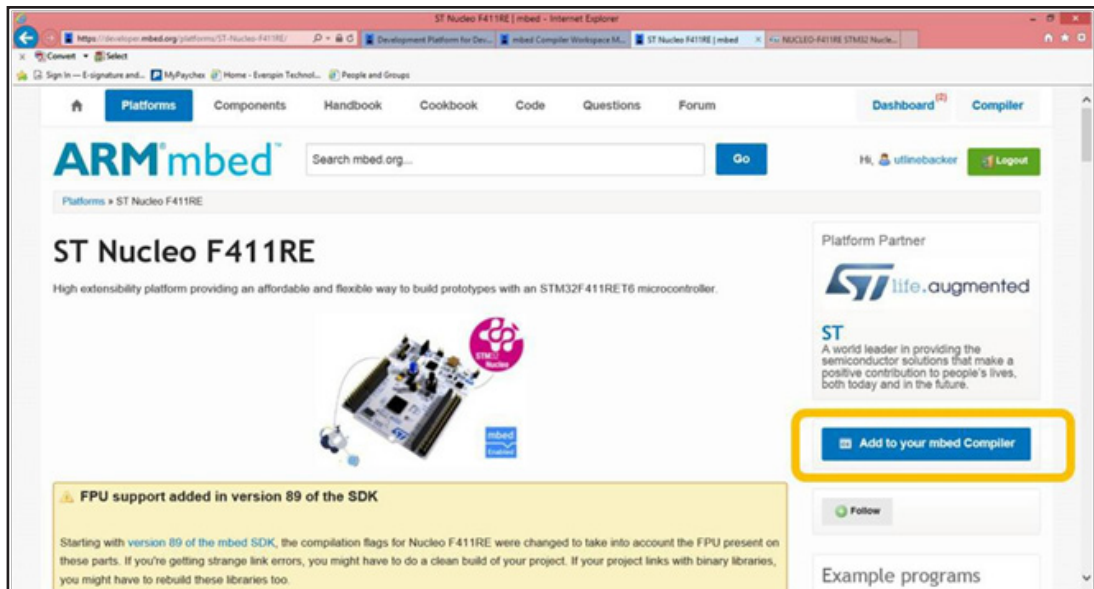

5. The platform will be added to your registered platforms list.

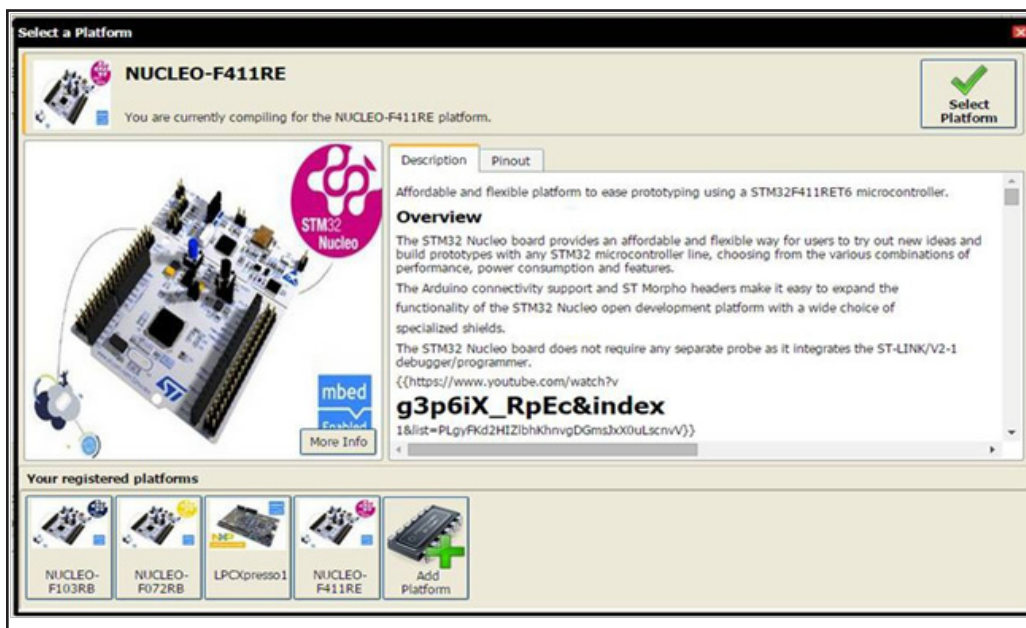

Setup (Continued)

Step 5: Import the Everspin Serial MRAM demonstration program. The example code is available on www.mbed.org.

1. In your Workspace, click **Import**.

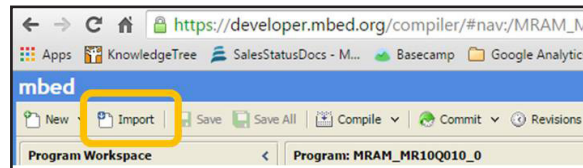

2. The **Import a program** dialog box will open. Click on the **Programs** tab.

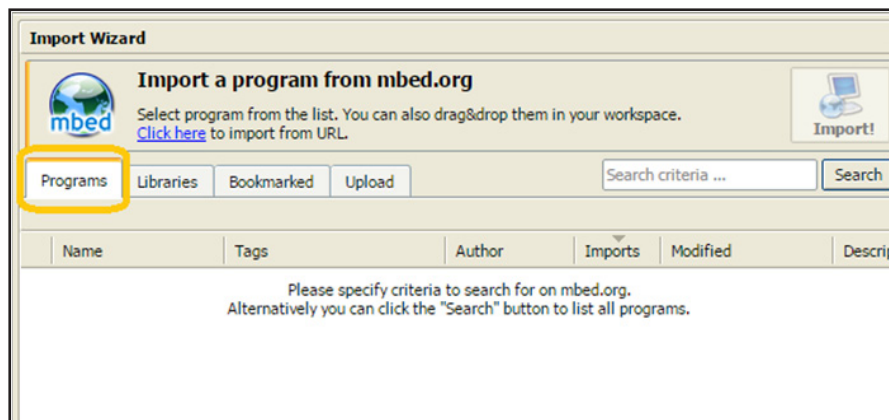

3. Search for the "MR25H00-EVAL" program, select it and click **Import!**
4. The demonstration program will now appear in the Program Workspace.

Setup (Concluded)

Step 6: Compile the binary file and load to your MCU evaluation board.

1. Highlight the **MRAM_MR25H00-EVAL** program folder in your **Program Workspace** tree in the left-hand column.
2. Click **Compile** in the top menu.

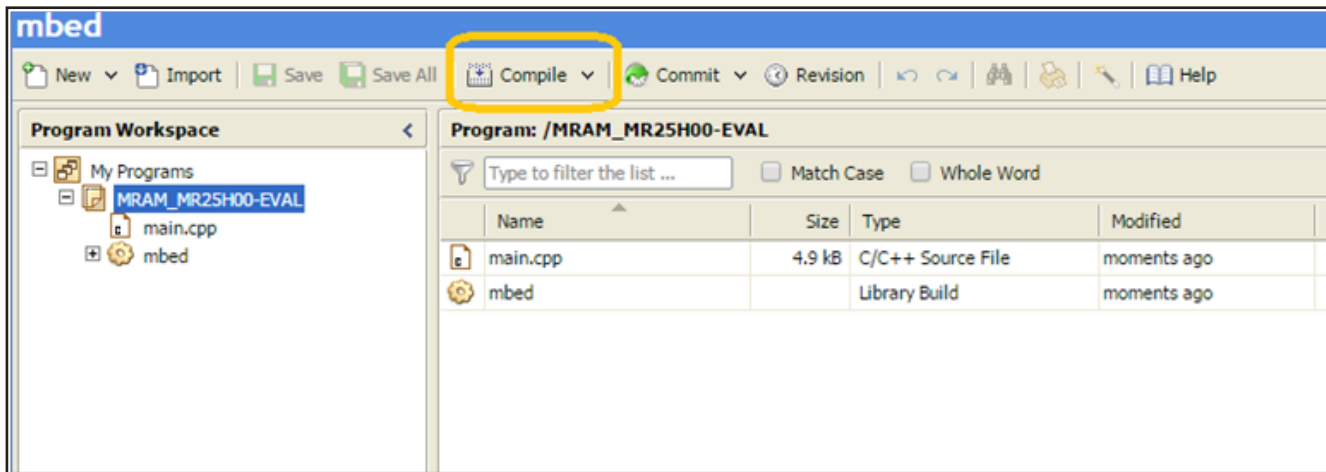

3. The program will be compiled and the binary (.bin) file created will automatically be downloaded to your computer's designated download location.
4. Drag and drop the binary file into the host board drive that you created in **Step 2**. When the file is dropped into the folder, your MCU host board will begin to program. The LED on your host board may blink a few times to confirm that the program is loading. When the program is fully loaded, the binary file will automatically delete from your MCU host board drive.

Run the Demonstration

Step 1: Use a terminal emulator to run the demonstration.

1. Use your favorite terminal emulator. For this example, we used the Tera Term emulator from SourceForge at <http://en.osdn.jp/projects/ttssh2/releases/>.
2. After installing, open Tera Term and select the serial port associated with your host board to create a new connection.
3. Configure the serial port under **Setup->Serial port with: 115200 baud, 8-N-1**.

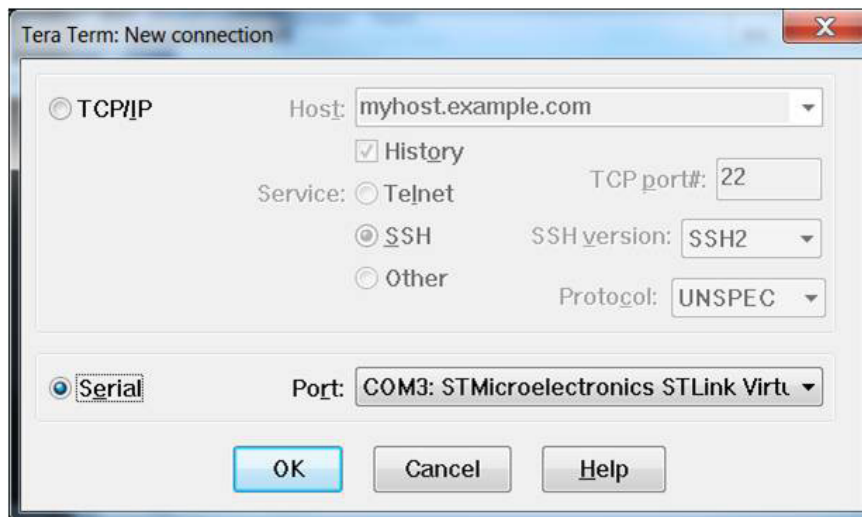

4. Press any key on the keyboard or the **Reset** button on your MCU host board to run the demonstration and view the demonstration output on the terminal emulator.
5. Every time the demo is run, the test count is incremented to demonstrate memory non-volatility and the performance is calculated for reading/writing the full array.

Export the Demonstration Code to Other Toolchains

You may export the demonstration code to work with other ARM-based toolchains.

1. Once you have the Everspin MR25H00-EVAL example program loaded into ARM mbed you may export it for development in production ARM tool chains.
2. Right click on the MRAM_MR25H00-EVAL program in the left column of the workspace and select **Export Program**.
3. Using **Export Target** and **Export Toolchain** in the dialog box, pick the target MCU host board and Toolchain for export and click on the **Export** button. The Everspin MR25H00-EVAL example code will be exported to the tool chain you selected.

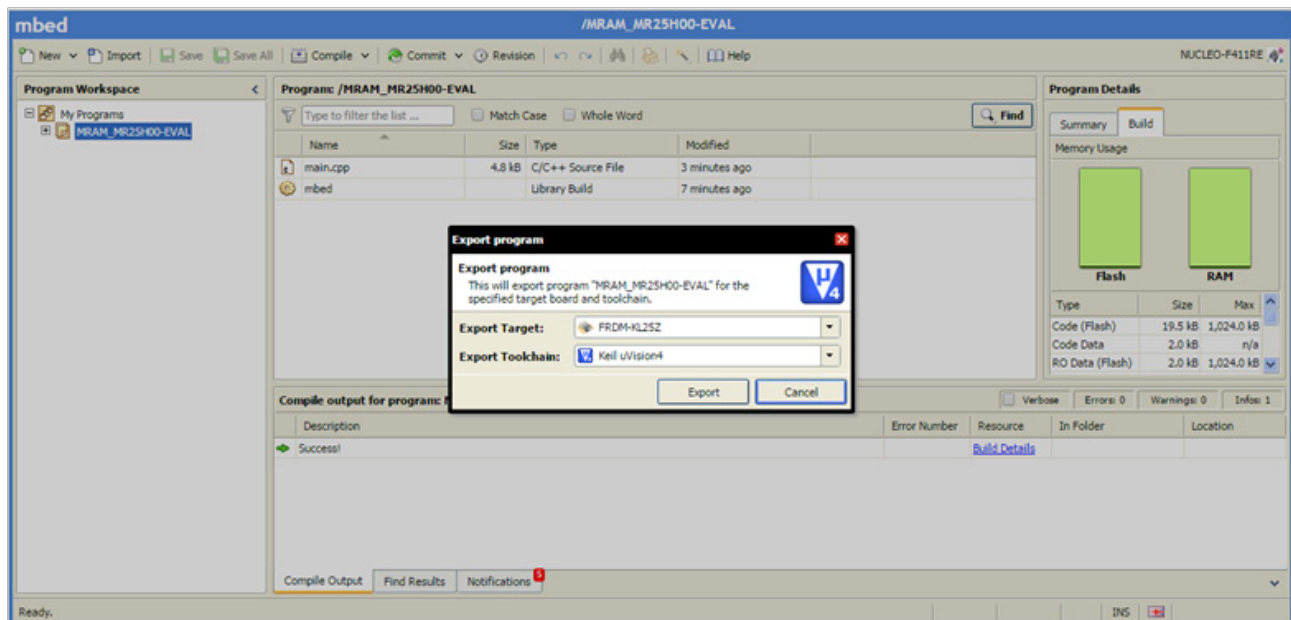

Questions?

We are here to help. Please use the Information Request on our web site to let us know how we can be of assistance.

Appendix A: MR25H00-EVAL Schematic

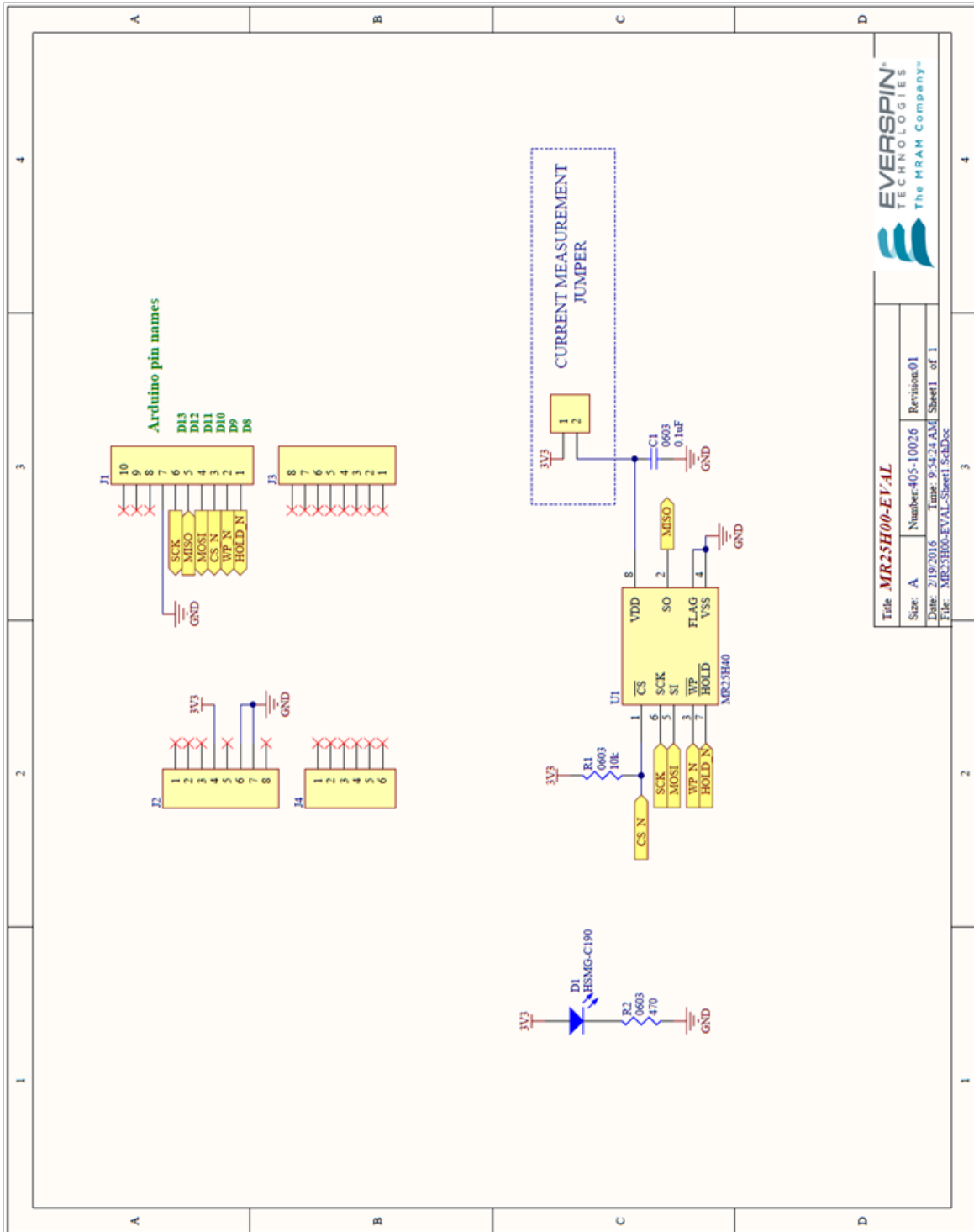

Appendix A (Cont'd): MR25H00-EVAL PCB Layout

PCB Top

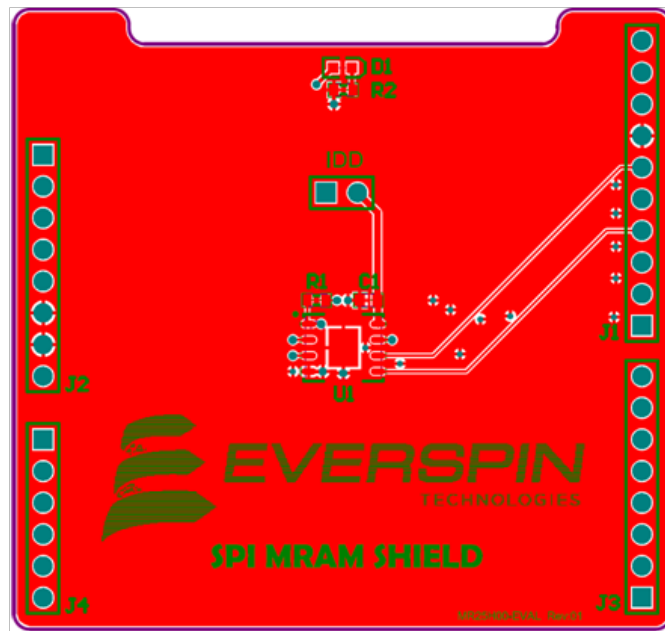

PCB Bottom

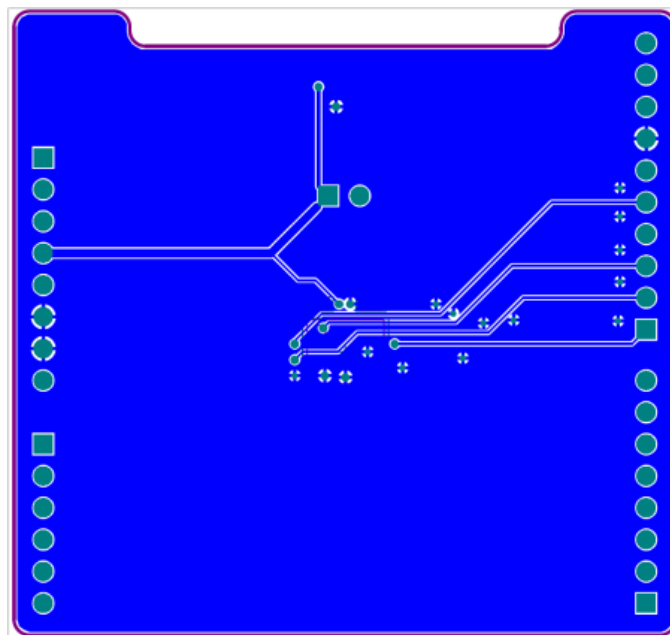

REVISION HISTORY

Revision	Date	Description of Change
1.0	February 24, 2016	Initial Release MR25H00-EVAL User Guide.

HOW TO REACH US

Everspin Technologies, Inc.

Home Page:

www.everspin.com

World Wide Information Request**WW Headquarters - Chandler, AZ**

1347 N. Alma School Road, Suite 220
Chandler, Arizona 85224

Tel: +1-877-480-MRAM (6726)

Local Tel: +1-480-347-1111

Fax: +1-480-347-1175

Europe, Middle East and Africa

Everspin Sales Office

Tel: +49 8168 998019

Japan

Everspin Sales Office

Tel: +1 (719) 650-5012

Asia Pacific

Everspin Sales Office

Tel: +86-136-0307-6129

Fax: +1-480-347-1175

Information in this document is provided solely to enable system and software implementers to use Everspin Technologies products. There are no express or implied licenses granted hereunder to design or fabricate any integrated circuit or circuits based on the information in this document. Everspin Technologies reserves the right to make changes without further notice to any products herein. Everspin makes no warranty, representation or guarantee regarding the suitability of its products for any particular purpose, nor does Everspin Technologies assume any liability arising out of the application or use of any product or circuit, and specifically disclaims any and all liability, including without limitation consequential or incidental damages. "Typical" parameters, which may be provided in Everspin Technologies data sheets and/or specifications can and do vary in different applications and actual performance may vary over time. All operating parameters including "Typicals" must be validated for each customer application by customer's technical experts. Everspin Technologies does not convey any license under its patent rights nor the rights of others. Everspin Technologies products are not designed, intended, or authorized for use as components in systems intended for surgical implant into the body, or other applications intended to support or sustain life, or for any other application in which the failure of the Everspin Technologies product could create a situation where personal injury or death may occur. Should Buyer purchase or use Everspin Technologies products for any such unintended or unauthorized application, Buyer shall indemnify and hold Everspin Technologies and its officers, employees, subsidiaries, affiliates, and distributors harmless against all claims, costs, damages, and expenses, and reasonable attorney fees arising out of, directly or indirectly, any claim of personal injury or death associated with such unintended or unauthorized use, even if such claim alleges that Everspin Technologies was negligent regarding the design or manufacture of the part. Everspin™ and the Everspin logo are trademarks of Everspin Technologies, Inc. All other product or service names are the property of their respective owners.

Copyright © 2016 Everspin Technologies, Inc.

Filename:

MR25H00-EVAL SPI Evaluation Board Guide Revision1 022416b

Компания «Life Electronics» занимается поставками электронных компонентов импортного и отечественного производства от производителей и со складов крупных дистрибьюторов Европы, Америки и Азии.

С конца 2013 года компания активно расширяет линейку поставок компонентов по направлению коаксиальный кабель, кварцевые генераторы и конденсаторы (керамические, пленочные, электролитические), за счёт заключения дистрибьюторских договоров

Мы предлагаем:

- Конкурентоспособные цены и скидки постоянным клиентам.
- Специальные условия для постоянных клиентов.
- Подбор аналогов.
- Поставку компонентов в любых объемах, удовлетворяющих вашим потребностям.
- Приемлемые сроки поставки, возможна ускоренная поставка.
- Доставку товара в любую точку России и стран СНГ.
- Комплексную поставку.
- Работу по проектам и поставку образцов.
- Формирование склада под заказчика.
- Сертификаты соответствия на поставляемую продукцию (по желанию клиента).
- Тестирование поставляемой продукции.
- Поставку компонентов, требующих военную и космическую приемку.
- Входной контроль качества.
- Наличие сертификата ISO.

В составе нашей компании организован Конструкторский отдел, призванный помогать разработчикам, и инженерам.

Конструкторский отдел помогает осуществить:

- Регистрацию проекта у производителя компонентов.
- Техническую поддержку проекта.
- Защиту от снятия компонента с производства.
- Оценку стоимости проекта по компонентам.
- Изготовление тестовой платы монтаж и пусконаладочные работы.



Тел: +7 (812) 336 43 04 (многоканальный)
Email: org@lifeelectronics.ru