

W6/W9 Series Magnetic Hydraulic P&B Circuit Breakers

- Designed for the international market. UL Recognized (UL1077 and UL1500), CSA Accepted and VDE approved.
- Ratings to 50 amps.
- Heavy duty #10-32 stud connections. (W9)
- Quick-connect or screw terminals. (W6)
- Several delay curve options.
- Choice of toggle or rocker actuator per pole or per unit (W6).
- Trip-free operation.

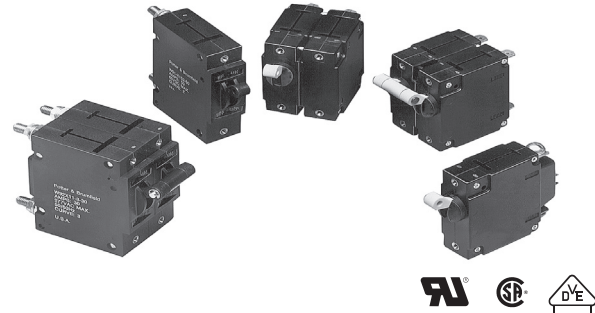

Agency Approvals

UL: Recognized as Supplementary Protector under UL 1077. Available models meet Ignition Protection requirements in accordance with UL1500. File E69543

CSA: Accepted as a Supplementary Protector. File LR15734.

VDE: Approved to VDE 0642/EN 60 934 (Circuit Breakers for Equipment) License No. 73782

Users should thoroughly review the technical data before selecting a product part number. It is recommended that users also seek out the pertinent approvals files of the agencies/laboratories and review them to confirm the product meets the requirements for a given application.

Electrical Data

Calibration:

Breakers will hold 100% of rated current.

Breakers may trip between 101% and 124% of rated load (134% for AC/DC units).

Breakers must trip at 125% of rated load and above (135% for AC/DC units).

Dielectric Strength: 50/60 Hz., 1500V: DC, 1100V

Insulation Resistance: 100 Megaohms at 500VDC

Endurance:

10,000 on/off cycles - 6000 at rated load, 4000 at no load.

Units tested at six cycles per minute, 1 second on and 9 seconds off at 25°C ambient.

Typical Resistance and Impedance

Current (Amps.)	DC Resistance (Ohms)	50/60 Impedance (Ohms)
0.2	90	90
1.0	1.2	1.2
2.0	0.28	0.28
5.0	0.04	0.04
10.0	0.013	0.013
20.0	0.004	0.005
30.0	0.0027	0.004
40.0	0.002	0.002
50.0	0.0015	0.0015

Tolerance: 0.1 - 4.99 ± 15%; 5 - 9.99 ± 20%; 10 - 15 ± 25%; 16 - 30 ± 50%.

Mechanical/Environmental Data

Operating Temperature: -40°C to +85°C.

Humidity: Meets requirements of Mil-STD-202 method 103.

Shock: Tested per Mil-STD-202, method 213, test condition C (100g @ 6 ms)

Vibration: Tested per Mil-STD-202, method 201, 10-55 Hz., 0.06" (1.52mm) total excursion in 2 planes.

Mechanical/Environmental Data (continued)

Fungus and Moisture Resistance:

Special moisture resistant finish applied to all ferrous parts. Plastic parts are made of inherently fungus resistant material.

Marking:

International "1" and "0" symbols are marked on the toggle for both W6 and W9. W9 units have "ON" and "OFF" molded into the area at the base of the toggle. On a special order basis, graphics can be imprinted on the rockers of rocker actuated W6 units. VDE approved versions of rocker actuated W6 breakers have their rockers imprinted with "1" and "0".

Mounting:

Units are mounted with two #6-32 screws from the front of the panel. Metric models for use with M3 x 0.5 screws are available. To maintain published performance specifications, units should not be mounted more than 90° from their normal upright position.

Weight: Approximately 2.5 ounces per pole.

Approvals and Ratings Table 1

W6 Series		UL1077/CSA (All Circuit Functions)		
Maximum Voltage	Frequency (Hz)	Phase	Current Rating (Amps)	Interrupting Capacity (Amps)
65	DC	-	0.2 - 50	2,000
277	50/60	1	0.2 - 20	5,000
277	50/60	1	21 - 50	2,500
277/480	50/60	3Ø-Wye	0.2 - 20	5,000

W9 Series		UL1077/CSA (All Circuit Functions)		
Maximum Voltage	Frequency (Hz)	Phase	Current Rating (Amps)	Interrupting Capacity (Amps)
65	DC	-	0.2 - 50	2,000
277	50/60	1	0.2 - 50	5,000
277/480	50/60	3Ø-Wye	0.2 - 20	5,000

W6 or W9 Series		VDE (Circuit Function X)		
Maximum Voltage	Frequency (Hz)	Phase	Current Rating (Amps)	Interrupting Capacity (Amps)
65	DC	-	0.2 - 50	2,000
250	50/60	1	0.2 - 30	5,000
250	50/60	1	31 - 50	2,000
415/240	50/60	3Ø	0.2 - 30	5,000

W6 or W9 Series		UL1500 (Circuit Function X)		
Maximum Voltage	Frequency (Hz)	Phase	Current Rating (Amps)	Interrupting Capacity (Amps)
48	DC	-	0.2 - 50	3,000
125/250	50/60	1	0.2 - 50	1,000
250	50/60	3Ø-Wye	0.2 - 50	1,000

W6/W9 Series Magnetic Hydraulic P&B Circuit Breakers (Continued)

Time vs Current Trip Curves For W6 Series and W9 Series

AC 50/60 Hz.

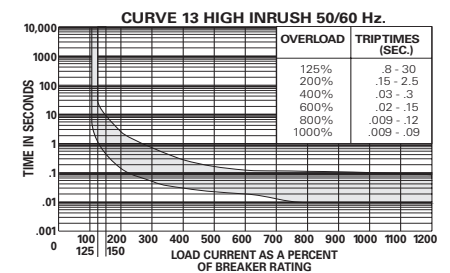
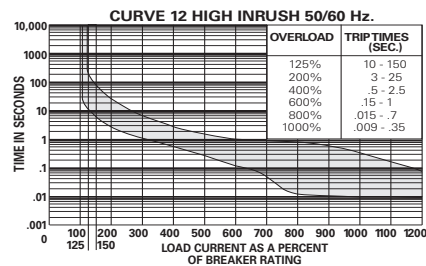
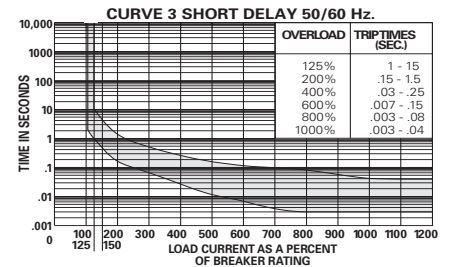
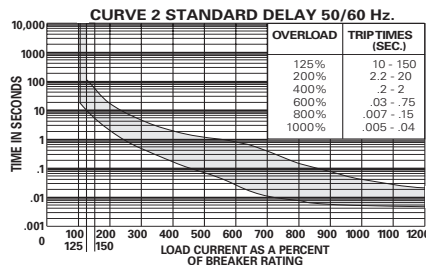

DC

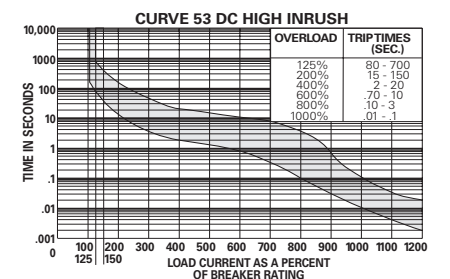
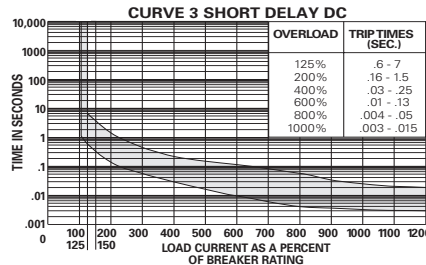

AC/DC

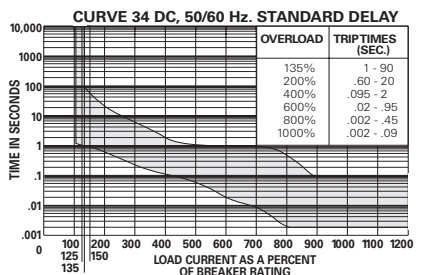

Note:

For instantaneous curves for all voltages refer to Curve 0 instantaneous under the AC 50/60 Hz. heading

W6/W9 Series Magnetic Hydraulic P&B Circuit Breakers (Continued)

Product code structure

Typical product code

W 67- X 2 Q 1 2- 20

W6 Series

Circuit Breaker Mounting

- W** #6-32 mounting threads
- M** M3.0 x 0.5 mounting threads

Number of Poles

- 67** Single Pole
- 68** Two Pole
- 69** Three Pole
- 70** Four Pole

Circuit Function (Only X is VDE approved)

- X** Series trip

Actuator

One actuator per pole

- 1** Black toggle **3** Black rocker **5** Red rocker **9** Red toggle
- 2** White toggle **4** White rocker **6** Grey rocker

One actuator per unit

- 7** Black toggle **8** White toggle **J** Black rocker

Termination

- Q** .250" QC (DIN 46 244) [30A Max. UL/CSA; 25A Max. VDE]
- S** #8-32 screw [30A Max.]
- T** #10-32 screw [50A Max.]
- U** #8-32 screw, nickel plated, bent inward 30° [30A Max.]
- V** #10-32 screw, nickel plated, bent inward 30° [30A Max.]

Notes:

#10-32 termination must be used for **all** ratings of greater than 30 amps.
#10-32 termination must be specified for circuit function D, but relay trip pole will be equipped with .250" QC.

Maximum Line Voltage (see Table 1 for current ranges)

- UL/CSA** 1 277VAC, 50/60 Hz.
- Types** 2 277/480VAC, 50/60 Hz. [20A Max.] (Requires insulating barriers, see outline dimension drawing)
- 5 65VDC
- 7 AC/DC 277VAC, 50/60 Hz. or 65VDC (Time delay curve 34 must be specified)
- 8 AC/DC 120VAC, 120/240VAC, 48VDC (Agency Approval M [UL1500] and time delay curve 34 must be specified)
- VDE** 1 250VAC, 415/240VAC
- Types** 5 65VDC
- 7 AC/DC 250VAC, 415/240VAC, 65VDC (Time delay curve 34 must be specified)

Time Delay Curve

- 0** Instantaneous
- 2** Standard delay
- 3** Short delay
- 53** DC high inrush
- 10** AC high inrush motor start / long delay
- 12** AC high inrush version of #2
- 13** AC high inrush version of #3
- 34** Combination AC/DC standard delay

Amp Rating

0.2	0.50	1.0	2.0	3.0	4.0	6.0	7.5	9.0	11.0	15.0	25.0	35.0	45.0	Consult factory for other values
0.25	0.75	1.5	2.5	3.5	5.0	7.0	8.0	10.0	12.0	20.0	30.0	40.0	50.0	

Agency Approval

- Blank** UL1077/CSA breaker
- V** VDE approved breaker
- M** UL1077/UL1500 ignition protected breaker

Authorized distributors are more likely to stock the following items.

W67-X2Q10-3	W67-X2Q12-10	W67-X2Q13-3	W67-X2Q50-5	W67-X2Q52-30	W68-X2Q12-10	W68-X2Q110-10	W69-X2Q12-25
W67-X2Q10-5	W67-X2Q12-15	W67-X2Q13-10	W67-X2Q50-10	W67-X2Q110-15	W68-X2Q12-15	W68-X2Q110-20	W69-X2Q12-30
W67-X2Q12-2	W67-X2Q12-20	W67-X2Q13-15	W67-X2Q52-5	W67-X2Q110-20	W68-X2Q12-20	W69-X2Q12-5	W69-X2Q110-20
W67-X2Q12-3	W67-X2Q12-30	W67-X2Q13-20	W67-X2Q52-10	W68-X2Q12-3	W68-X2Q12-25	W69-X2Q12-10	W69-X2Q110-30
W67-X2Q12-5	W67-X2Q13-1	W67-X2Q13-25	W67-X2Q52-15	W68-X2Q12-5	W68-X2Q12-30	W69-X2Q12-15	
W67-X2Q12-7	W67-X2Q13-2	W67-X2Q13-30	W67-X2Q52-20	W68-X2Q12-7	W68-X2Q13-15	W69-X2Q12-20	

W6/W9 Series Magnetic Hydraulic P&B Circuit Breakers (Continued)

Product code structure	Typical product code	W	91-	X	1	1	2-	20	
W9 Series									
Circuit Breaker Mounting									
W #6-32 mounting threads									
M M3.0 x 0.5 mounting threads									
Number of Poles									
91 Single Pole									
92 Two Pole									
93 Three Pole									
94 Four Pole									
Circuit Function (Only X is VDE approved)									
X Series trip									
Actuator									
One actuator per pole									
1 Black toggle									
2 White toggle									
Maximum Line Voltage (see Table 1 for current ranges)									
UL/CSA	1	277VAC, 50/60 Hz.							
Types	2	277/480VAC, 50/60 Hz. [20A Max.]							
	5	65VDC							
	7	AC/DC 277VAC, 50/60 Hz. or 65VDC (Time delay curve 34 must be specified)							
	8	AC/DC 120VAC, 120/240VAC, 48VDC (Agency Approval M [UL1500] and time delay curve 34 must be specified)							
VDE	1	250VAC, 415/240VAC							
Types	5	65VDC							
	7	AC/DC 250VAC, 415/240VAC, 65VDC (Time delay curve 34 must be specified)							
Time Delay Curve									
0 Instantaneous	10	AC high inrush motor start / long delay							
2 Standard delay	12	AC high inrush version of #2							
3 Short delay	13	AC high inrush version of #3							
53 DC high inrush	34	Combination AC/DC standard delay							
Amp Rating									
0.20	0.75	2.0	3.5	6.0	8.0	11.0	20.0	35.0	50.0
0.25	1.00	2.5	4.0	7.0	9.0	12.0	25.0	40.0	Consult factory for other values
0.50	1.50	3.0	5.0	7.5	10.0	15.0	30.0	45.0	
Agency Approval									
Blank	UL1077/CSA approved breaker								
V	VDE approved breaker								
M	UL1077/UL1500 ignition protected breaker								

Authorized distributors are more likely to stock the following items.

W91-X112-1	W91-X112-15	W91-X113-15	W91-X152-40	W92-X112-5	W92-X112-30	W92-X1110-30	W93-X112-30
W91-X112-2	W91-X112-20	W91-X150-5	W91-X152-50	W92-X112-7	W92-X112-40	W93-X112-5	W93-X112-40
W91-X112-3	W91-X112-40	W91-X152-10	W91-X1110-20	W92-X112-10	W92-X112-50	W93-X112-10	W93-X112-50
W91-X112-5	W91-X112-50	W91-X152-15	W92-X112-1	W92-X112-15	W92-X113-15	W93-X112-15	W93-X1110-20
W91-X112-7	W91-X113-5	W91-X152-20	W92-X112-2	W92-X112-20	W92-X113-20	W93-X112-20	W93-X1110-30
W91-X112-10	W91-X113-10	W91-X152-30	W92-X112-3	W92-X112-25	W92-X1110-20	W93-X112-25	

W6/W9 Series Magnetic Hydraulic P&B Circuit Breakers (Continued)

Outline Dimensions - Toggle Actuator Models

W6 Series



Panel Mounting Cutout



W6 Series - One Actuator Per Pole

1 Pole



2 Pole



3 Pole



4 Pole



Note: Multi-pole models furnished with separate handle tie hardware

W6 Series - One Actuator Per Unit

1 Pole



2 Pole



3 Pole



4 Pole



Note: 4-pole models furnished with separate handle tie hardware

480V Model with Barriers



Note: 3-pole model shown

Notes:

1. Terminal protrusion dimensions are referenced from back of mounting panel
2. Main terminals are male quick connect type .250 (6.35) wide x .031 (.79) thick x .377 (9.58) long. Optional 8-32 x .250 (6.35) or 10-32 x .250 (6.35) screw type
3. Panel mounting cutout detail mtg. detail tol.: $\pm .005$ (.13) unless noted. Add additional cutouts to correspond to number of poles. Outline drawing tolerance $\pm .015$ (.35) unless noted

Termination Options



W6/W9 Series Magnetic Hydraulic P&B Circuit Breakers (Continued)

Outline Dimensions - Optional Toggle Guards

W6 Series

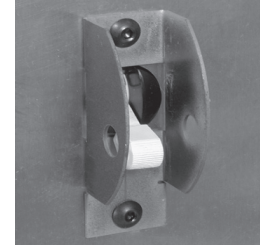
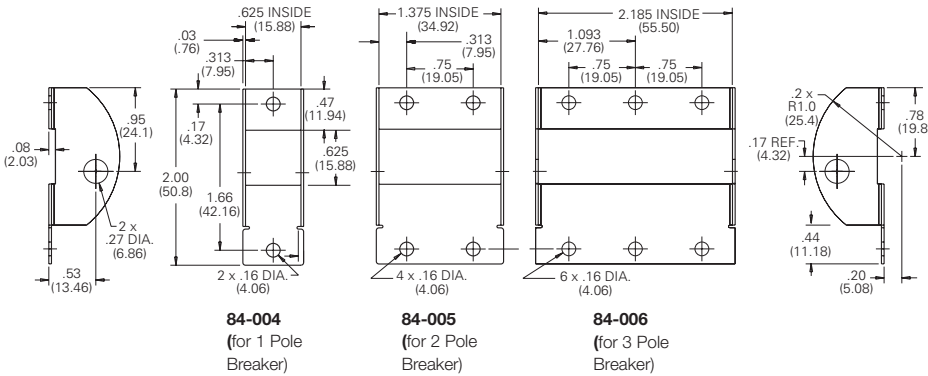

84-004 toggle guard shown with W67 series circuit breaker mounted in a panel.

Optional toggle guards may be ordered separately for use on W6 toggle actuator models. These guards help to prevent accidental operation and allow the breaker to be locked in the "off" position.

Outline Dimensions - Rocker Actuator Models

W6 Series

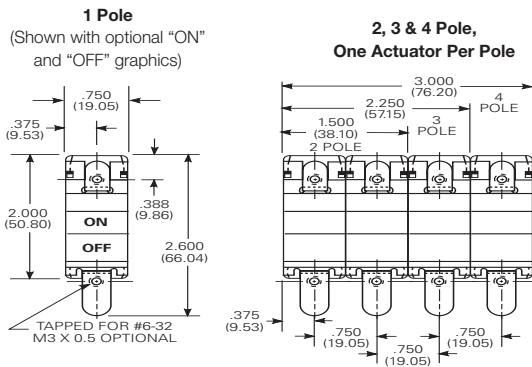
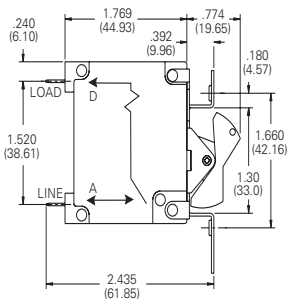

2, 3 & 4 Pole, One Actuator Per Unit

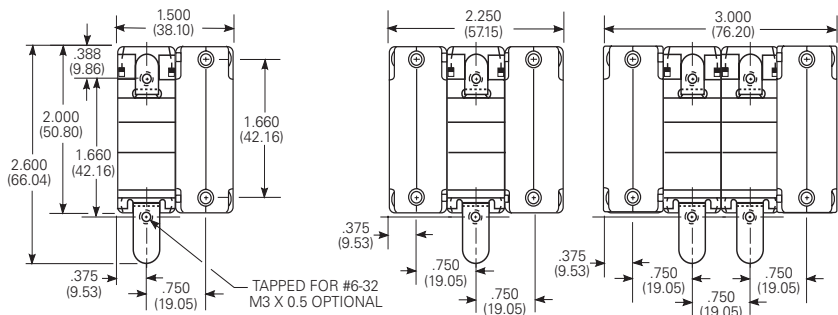

Panel Mounting Cutout

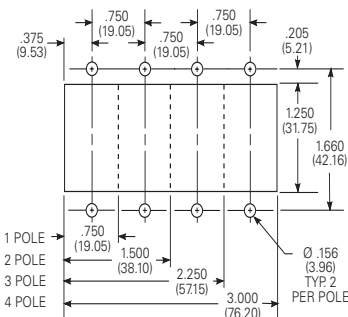

VDE Rocker Marking

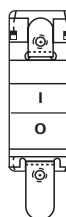

Notes:

1. Outline drawing tolerance $\pm .015$ (.38) unless noted. Dimensions in brackets () are in millimeters.
2. Mounting Detail Tol. $\pm .005$ (.013) unless noted

W6/W9 Series Magnetic Hydraulic P&B Circuit Breakers (Continued)

Outline Dimensions

W9 Series

Series Trip Model

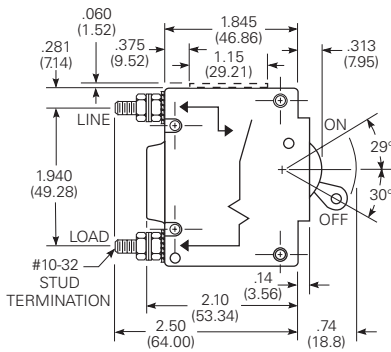

Note:

1. Top mounted plate (shown with broken line) is present only on UL1500 models

Series Trip Model

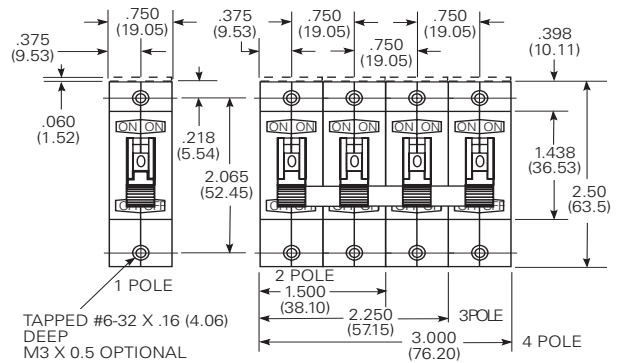

Panel Mounting Cutout Detail

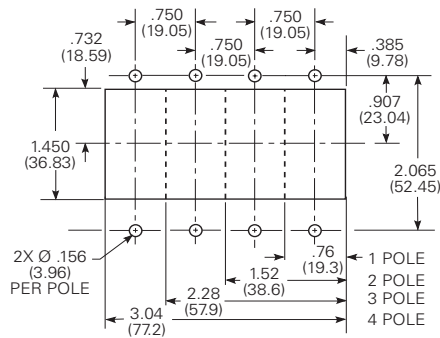

Notes:

1. Terminal protrusion dimensions are referenced from the back of the mounting panel
 2. Mounting detail tolerance $\pm .005$ (13) unless noted
 3. Outline drawing tolerance $\pm .015$ (.38) unless noted
- Dimensions in brackets () are in millimeters.

Disclaimer:

While TE and its affiliates referenced herein have made every reasonable effort to ensure the accuracy of the information contained in this document, TE cannot assure that this information is error free. For this reason, TE does not make any representation or offer any guarantee that such information is accurate, correct, reliable or current. TE reserves the right to make any adjustments to the information at any time. TE expressly disclaims any implied warranty regarding the information contained herein, including, but not limited to, the implied warranties of merchantability or fitness for a particular purpose. TE's only obligations are those stated in TE's Standard Terms and Conditions of Sale. TE will in no case be liable for any incidental, indirect or consequential damages arising from or in connection with, including, but not limited to, the sale, resale, use or misuse of its products. Users should rely on their own judgment to evaluate the suitability of a product for a certain purpose and test each product for its intended application.

In case of any potential ambiguities or questions, please don't hesitate to contact us for clarification.

Компания «Life Electronics» занимается поставками электронных компонентов импортного и отечественного производства от производителей и со складов крупных дистрибьюторов Европы, Америки и Азии.

С конца 2013 года компания активно расширяет линейку поставок компонентов по направлению коаксиальный кабель, кварцевые генераторы и конденсаторы (керамические, пленочные, электролитические), за счёт заключения дистрибьюторских договоров

Мы предлагаем:

- Конкурентоспособные цены и скидки постоянным клиентам.
- Специальные условия для постоянных клиентов.
- Подбор аналогов.
- Поставку компонентов в любых объемах, удовлетворяющих вашим потребностям.
- Приемлемые сроки поставки, возможна ускоренная поставка.
- Доставку товара в любую точку России и стран СНГ.
- Комплексную поставку.
- Работу по проектам и поставку образцов.
- Формирование склада под заказчика.
- Сертификаты соответствия на поставляемую продукцию (по желанию клиента).
- Тестирование поставляемой продукции.
- Поставку компонентов, требующих военную и космическую приемку.
- Входной контроль качества.
- Наличие сертификата ISO.

В составе нашей компании организован Конструкторский отдел, призванный помогать разработчикам, и инженерам.

Конструкторский отдел помогает осуществить:

- Регистрацию проекта у производителя компонентов.
- Техническую поддержку проекта.
- Защиту от снятия компонента с производства.
- Оценку стоимости проекта по компонентам.
- Изготовление тестовой платы монтаж и пусконаладочные работы.



Тел: +7 (812) 336 43 04 (многоканальный)

Email: org@lifeelectronics.ru