



Is Now Part of



ON Semiconductor®

To learn more about ON Semiconductor, please visit our website at
www.onsemi.com

Please note: As part of the Fairchild Semiconductor integration, some of the Fairchild orderable part numbers will need to change in order to meet ON Semiconductor's system requirements. Since the ON Semiconductor product management systems do not have the ability to manage part nomenclature that utilizes an underscore (_), the underscore (_) in the Fairchild part numbers will be changed to a dash (-). This document may contain device numbers with an underscore (_). Please check the ON Semiconductor website to verify the updated device numbers. The most current and up-to-date ordering information can be found at www.onsemi.com. Please email any questions regarding the system integration to Fairchild_questions@onsemi.com.

ON Semiconductor and the ON Semiconductor logo are trademarks of Semiconductor Components Industries, LLC dba ON Semiconductor or its subsidiaries in the United States and/or other countries. ON Semiconductor owns the rights to a number of patents, trademarks, copyrights, trade secrets, and other intellectual property. A listing of ON Semiconductor's product/patent coverage may be accessed at www.onsemi.com/site/pdf/Patent-Marking.pdf. ON Semiconductor reserves the right to make changes without further notice to any products herein. ON Semiconductor makes no warranty, representation or guarantee regarding the suitability of its products for any particular purpose, nor does ON Semiconductor assume any liability arising out of the application or use of any product or circuit, and specifically disclaims any and all liability, including without limitation special, consequential or incidental damages. Buyer is responsible for its products and applications using ON Semiconductor products, including compliance with all laws, regulations and safety requirements or standards, regardless of any support or applications information provided by ON Semiconductor. "Typical" parameters which may be provided in ON Semiconductor data sheets and/or specifications can and do vary in different applications and actual performance may vary over time. All operating parameters, including "Typicals" must be validated for each customer application by customer's technical experts. ON Semiconductor does not convey any license under its patent rights nor the rights of others. ON Semiconductor products are not designed, intended, or authorized for use as a critical component in life support systems or any FDA Class 3 medical devices or medical devices with a same or similar classification in a foreign jurisdiction or any devices intended for implantation in the human body. Should Buyer purchase or use ON Semiconductor products for any such unintended or unauthorized application, Buyer shall indemnify and hold ON Semiconductor and its officers, employees, subsidiaries, affiliates, and distributors harmless against all claims, costs, damages, and expenses, and reasonable attorney fees arising out of, directly or indirectly, any claim of personal injury or death associated with such unintended or unauthorized use, even if such claim alleges that ON Semiconductor was negligent regarding the design or manufacture of the part. ON Semiconductor is an Equal Opportunity/Affirmative Action Employer. This literature is subject to all applicable copyright laws and is not for resale in any manner.

TIL111M, TIL117M, MOC8100M General Purpose 6-Pin Phototransistor Optocouplers

Features

- UL Recognized (File # E90700)
- VDE Recognized (File #102497 for white package)
 - Add Option V (e.g., TIL111VM)

Applications

- Power Supply Regulators
- Digital Logic Inputs
- Microprocessor Inputs
- Appliance Sensor Systems
- Industrial Controls

General Description

The MOC8100M, TIL111M, and TIL117M optocouplers consist of a gallium arsenide infrared emitting diode driving a silicon phototransistor in a 6-pin dual in-line package.

Schematic

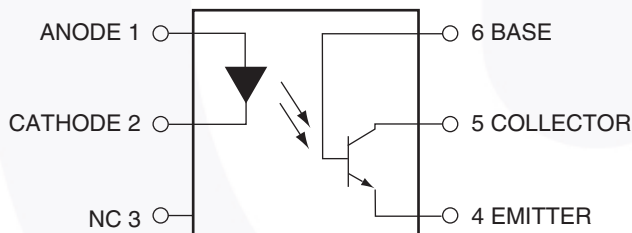

Figure 1. Schematic

Package Outlines

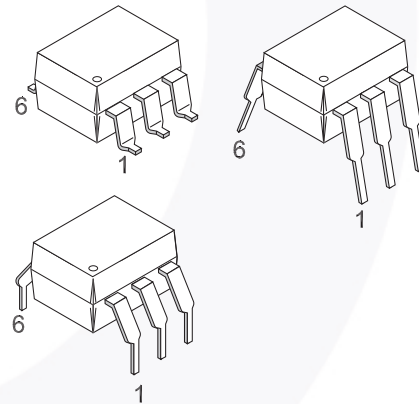

Figure 2. Package Outlines

Safety and Insulation Ratings

As per IEC60747-5-2. This optocoupler is suitable for “safe electrical insulation” only within the safety limit data. Compliance with the safety ratings shall be ensured by means of protective circuits.

| Symbol | Parameter | Min. | Typ. | Max. | Unit |
|-------------------|--|-----------------|-----------|------|-------------------|
| | Installation Classifications per DIN VDE 0110/1.89 Table 1 | | | | |
| | For Rated Mains Voltage < 150 V _{RMS} | | I-IV | | |
| | For Rated Mains Voltage < 300 V _{RMS} | | I-IV | | |
| | Climatic Classification | | 55/100/21 | | |
| | Pollution Degree (DIN VDE 0110/1.89) | | 2 | | |
| CTI | Comparative Tracking Index | 175 | | | |
| V _{PR} | Input to Output Test Voltage, Method b, V _{IORM} × 1.875 = V _{PR} , 100% Production Test with t _m = 1 s, Partial Discharge < 5 pC | 1594 | | | |
| | Input to Output Test Voltage, Method a, V _{IORM} × 1.5 = V _{PR} , Type and Sample Test with t _m = 60 s, Partial Discharge < 5 pC | 1275 | | | |
| V _{IORM} | Maximum Working Insulation Voltage | 850 | | | V _{peak} |
| V _{IOTM} | Highest Allowable Over Voltage | 6000 | | | V _{peak} |
| | External Creepage | 7 | | | mm |
| | External Clearance | 7 | | | mm |
| | Insulation Thickness | 0.5 | | | mm |
| R _{IO} | Insulation Resistance at T _S , V _{IO} = 500 V | 10 ⁹ | | | Ω |

Absolute Maximum Ratings

Stresses exceeding the absolute maximum ratings may damage the device. The device may not function or be operable above the recommended operating conditions and stressing the parts to these levels is not recommended. In addition, extended exposure to stresses above the recommended operating conditions may affect device reliability. The absolute maximum ratings are stress ratings only.

| Symbol | Parameter | Device | Value | Units |
|---------------------|---|-------------------|----------------|-------|
| Total Device | | | | |
| T _{STG} | Storage Temperature | All | -40 to +150 | °C |
| T _{OPR} | Operating Temperature | All | -40 to +100 | °C |
| T _{SOL} | Lead Solder Temperature | All | 260 for 10 sec | °C |
| P _D | Total Device Power Dissipation @ T _A = 25°C Derate Above 25°C | All | 250 | mW |
| | | | 2.94 | mW/°C |
| Emitter | | | | |
| I _F | DC/Average Forward Input Current | All | 60 | mA |
| V _R | Reverse Input Voltage | TIL111M | 3 | V |
| | | MOC8100M, TIL117M | 6 | |
| I _{F(pk)} | Forward Current – Peak (300 μs, 2% Duty Cycle) | All | 3 | A |
| P _D | LED Power Dissipation @ T _A = 25°C Derate Above 25°C | All | 120 | mW |
| | | | 1.41 | mW/°C |
| Detector | | | | |
| V _{CEO} | Collector-Emitter Voltage | All | 30 | V |
| V _{CBO} | Collector-Base Voltage | All | 70 | V |
| V _{ECO} | Emitter-Collector Voltage | TIL111M, TIL117M | 7 | V |
| V _{EBO} | Emitter-Base Voltage | All | 7 | |
| P _D | Detector Power Dissipation @ T _A = 25°C Derate Above 25°C | All | 150 | mW |
| | | | 1.76 | mW/°C |

Electrical Characteristics

$T_A = 25^\circ\text{C}$ unless otherwise specified.

Individual Component Characteristics

| Symbol | Parameter | Test Conditions | Device | Min. | Typ.* | Max. | Unit | |
|-----------------|-------------------------------------|--|--|----------------------|-------|-------|------|---------------|
| Emitter | | | | | | | | |
| V_F | Input Forward Voltage | $I_F = 16\text{ mA}$ | $T_A = 25^\circ\text{C}$ | TIL111M | | 1.2 | 1.4 | V |
| | | $I_F = 10\text{ mA}$ for MOC8100M, $I_F = 16\text{ mA}$ for TIL117M | $T_A = 0^\circ\text{C to } 70^\circ\text{C}$ | MOC8100M, TIL117M | | 1.2 | 1.4 | |
| | | | $T_A = -55^\circ\text{C}$ | | | 1.32 | | |
| | | | $T_A = +100^\circ\text{C}$ | | | 1.10 | | |
| I_R | Reverse Leakage Current | $V_R = 3.0\text{ V}$ | TIL111M, TIL117M | | | 0.001 | 10 | μA |
| | | $V_R = 6.0\text{ V}$ | MOC8100M | | | 0.001 | 10 | μA |
| Detector | | | | | | | | |
| BV_{CEO} | Collector-Emitter Breakdown Voltage | $I_C = 1.0\text{ mA}, I_F = 0$ | | All | 30 | 100 | | V |
| BV_{CBO} | Collector-Base Breakdown Voltage | $I_C = 10\text{ }\mu\text{A}, I_F = 0$ | | All | 70 | 120 | | V |
| BV_{EBO} | Emitter-Base Breakdown Voltage | $I_E = 10\text{ }\mu\text{A}, I_F = 0$ | | All | 7 | 10 | | V |
| BV_{ECO} | Emitter-Collector Breakdown Voltage | $I_F = 100\text{ }\mu\text{A}, I_F = 0$ | | TIL111M, TIL117M | 7 | 10 | | V |
| I_{CEO} | Collector-Emitter Dark Current | $V_{CE} = 10\text{ V}, I_F = 0$ | | TIL111M, TIL117M | | 1 | 50 | nA |
| | | $V_{CE} = 5\text{ V}, T_A = 25^\circ\text{C}$ | | MOC8100M | | 0.5 | 25 | nA |
| | | $V_{CE} = 30\text{ V}, I_F = 0, T_A = 70^\circ\text{C}$ | | TIL117M, MOC8100M | | 0.2 | 50 | μA |
| I_{CBO} | Collector-Base Dark Current | $V_{CB} = 10\text{ V}$ | | TIL111M, TIL117M | | | 20 | nA |
| | | $V_{CB} = 5\text{ V}$ | | MOC8100M | | | 10 | nA |
| C_{CE} | Capacitance | $V_{CE} = 0\text{ V}, f = 1\text{ MHz}$ | | All | | 8 | | pF |

*All Typical values at $T_A = 25^\circ\text{C}$

Electrical Characteristics (Continued) $T_A = 25^\circ\text{C}$ unless otherwise specified.**Transfer Characteristics**

| Symbol | Parameter | Test Conditions | Device | Min | Typ* | Max | Unit |
|---------------------------|--|---|----------|-----|------|-----|---------------|
| DC Characteristics | | | | | | | |
| CTR_{CE} | Current Transfer Ratio, Collector to Emitter | $I_F = 10\text{ mA}, V_{CE} = 10\text{ V}$ | TIL117M | 50 | | | % |
| | | $I_F = 1\text{ mA}, V_{CE} = 5\text{ V}$ | MOC8100M | 50 | | | % |
| | | $I_F = 1\text{ mA}, V_{CE} = 5\text{ V}, T_A = 0^\circ\text{C to } +70^\circ\text{C}$ | | 30 | | | |
| $I_{C(ON)}$ | On-State Collector Current (Phototransistor Operation) | $I_F = 16\text{ mA}, V_{CE} = 0.4\text{ V}$ | TIL111M | 2 | | | mA |
| | On-State Collector Current (Photodiode Operation) | $I_F = 16\text{ mA}, V_{CB} = 0.4\text{ V}$ | | 7 | | | μA |
| $V_{CE(SAT)}$ | Collector-Emitter Saturation Voltage | $I_C = 500\text{ }\mu\text{A}, I_F = 10\text{ mA}$ | TIL117M | | | 0.4 | V |
| | | $I_C = 2\text{ mA}, I_F = 16\text{ mA}$ | TIL111M | | | 0.4 | |
| | | $I_C = 100\text{ }\mu\text{A}, I_F = 1\text{ mA}$ | MOC8100M | | | 0.5 | |
| AC Characteristics | | | | | | | |
| c_{ON} | Turn-On Time | $I_C = 2\text{ mA}, V_{CC} = 10\text{ V}, R_L = 100\text{ }\Omega$ (Fig. 13) | MOC8100M | | | 20 | μs |
| | | | TIL117M | | | 10 | |
| c_{OFF} | Turn-Off Time | | MOC8100M | | | 20 | μs |
| | | | TIL117M | | | 10 | |
| t_r | Rise Time | | MOC8100M | | 2 | | μs |
| t_f | Fall Time | | TIL117M | | 2 | | |
| t_r | Rise Time (Phototransistor Operation) | $I_{C(ON)} = 2\text{ mA}, V_{CC} = 10\text{ V}, R_L = 100\text{ }\Omega$ (Fig. 13) | TIL111M | | | 10 | μs |
| t_f | Fall Time (Phototransistor Operation) | | | | | | |

Isolation Characteristics

| Symbol | Characteristic | Test Conditions | Min. | Typ.* | Max. | Units |
|-----------|--------------------------------|------------------------------------|-----------|-------|------|--------------|
| V_{ISO} | Input-Output Isolation Voltage | $f = 60\text{ Hz}, t = 1\text{ s}$ | 7500 | | | $V_{AC(PK)}$ |
| R_{ISO} | Isolation Resistance | $V_{I-O} = 500\text{ V}_{DC}$ | 10^{11} | | | Ω |
| C_{ISO} | Isolation Capacitance | $V_{I-O} = 0, f = 1\text{ MHz}$ | | 0.2 | | pF |

*All Typical values at $T_A = 25^\circ\text{C}$.

Typical Performance Characteristics

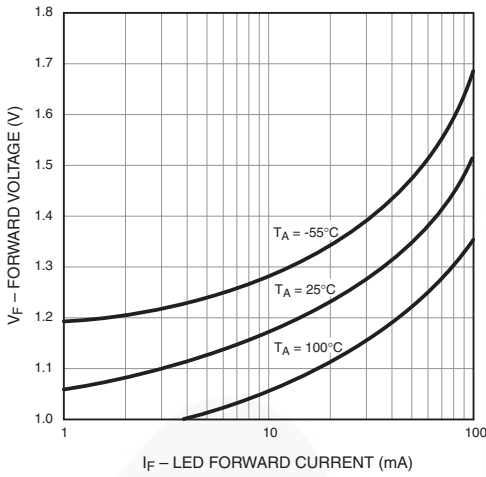

Figure 3. LED Forward Voltage vs. Forward Current

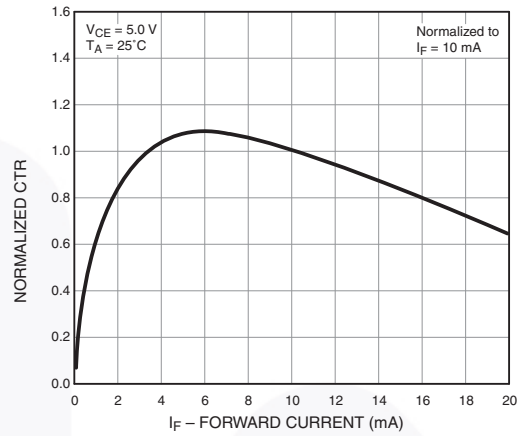

Figure 4. Normalized CTR vs. Forward Current

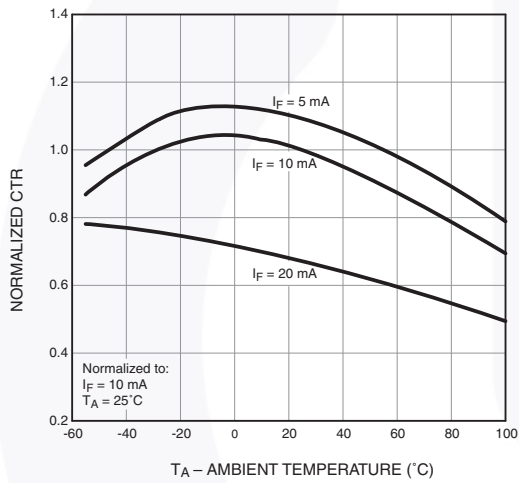

Figure 5. Normalized CTR vs. Ambient Temperature

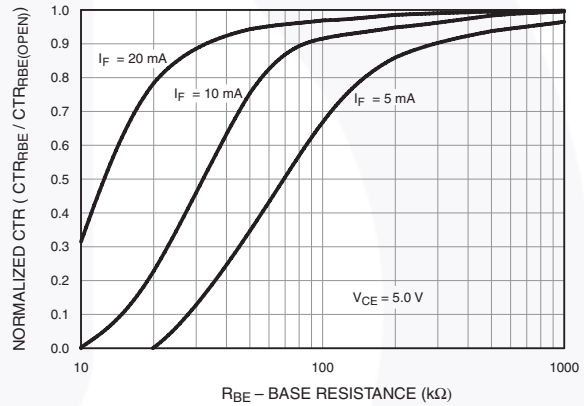

Figure 6. CTR vs. RBE (Unsaturated)

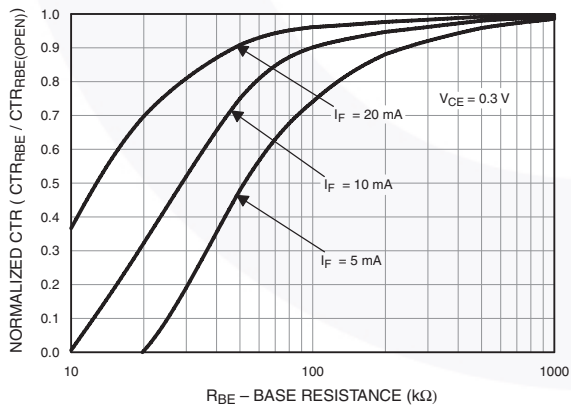

Figure 7. CTR vs. RBE (Saturated)

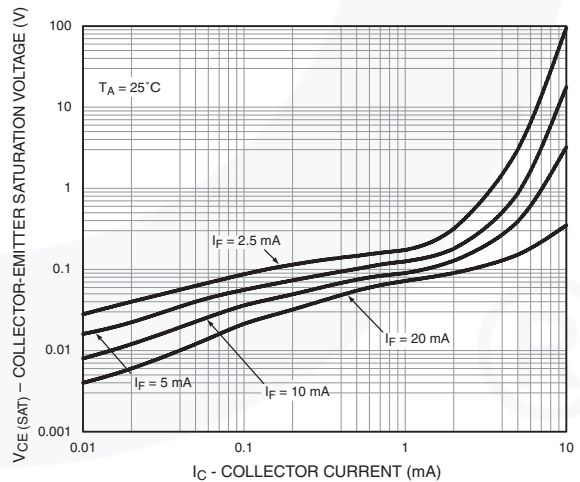

Figure 8. Collector-Emitter Saturation Voltage vs. Collector Current

Typical Performance Characteristics (Continued)

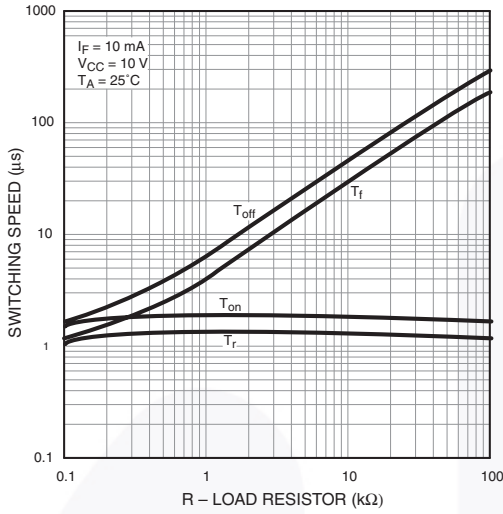

Figure 9. Switching Speed vs. Load Resistor

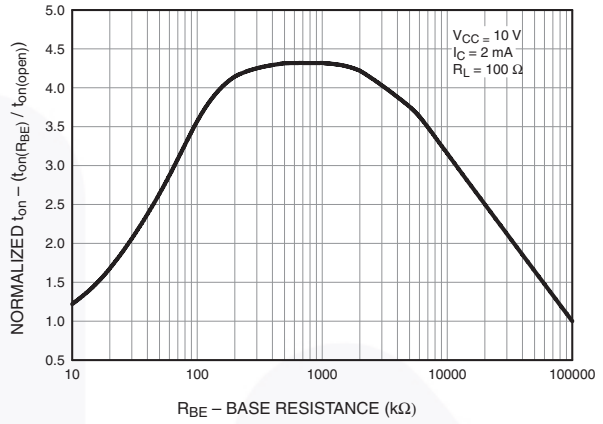

Figure 10. Normalized t_{on} vs. R_{BE}

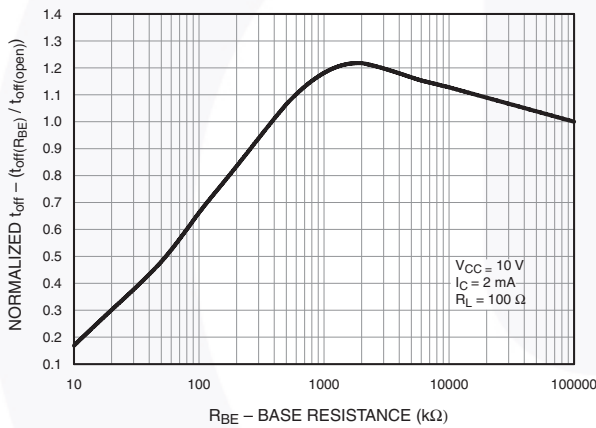

Figure 11. Normalized t_{off} vs. R_{BE}

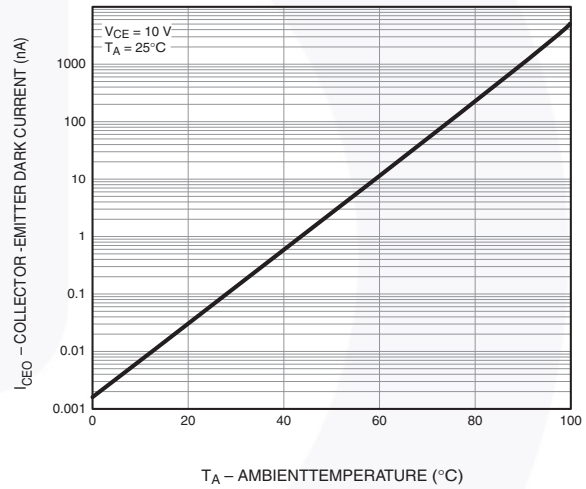

Figure 12. Dark Current vs. Ambient Temperature

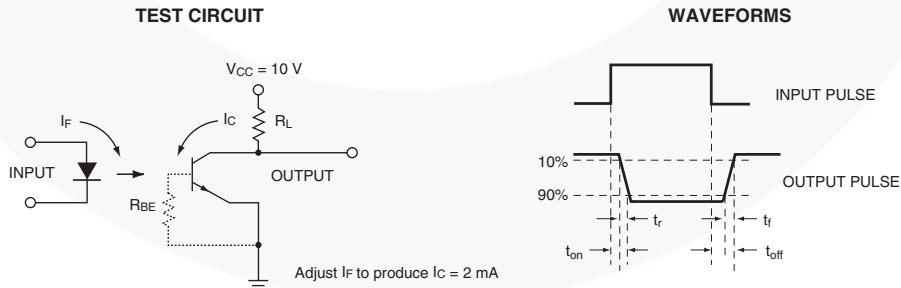

Figure 13. Switching Time Test Circuit and Waveforms

Reflow Profile

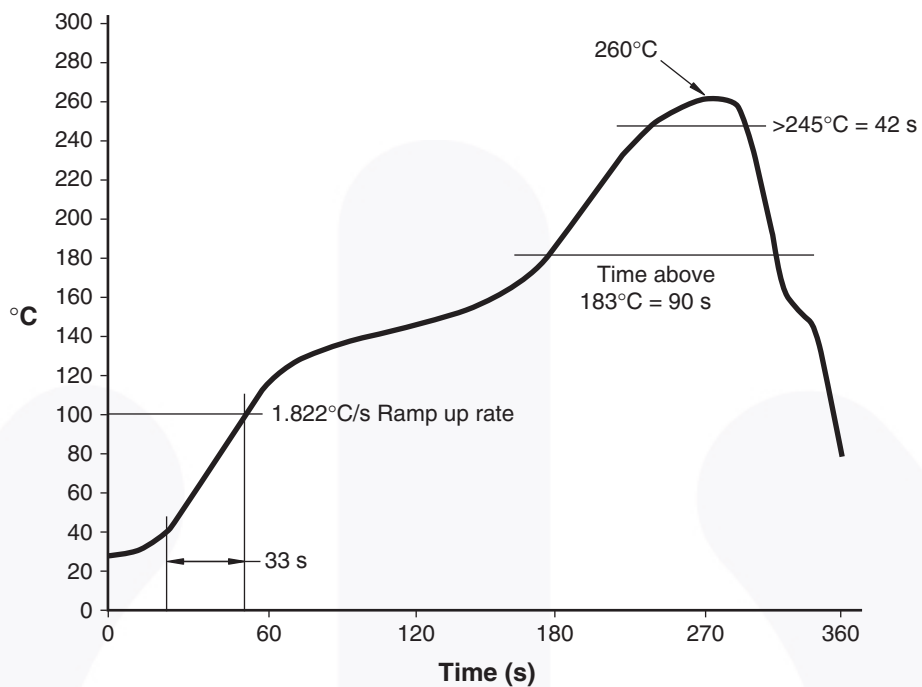
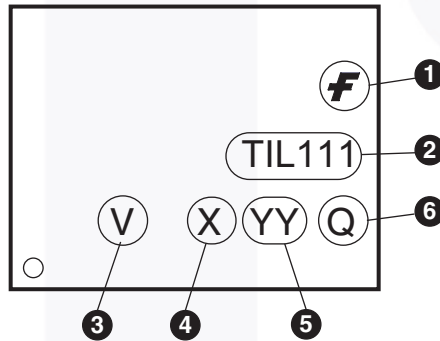

Figure 14. Reflow Profile

Ordering Information

| Option | Order Entry Identifier (Example) | Description |
|-----------|----------------------------------|--|
| No option | TIL111M | Standard Through-Hole Device |
| S | TIL111SM | Surface Mount Lead Bend |
| SR2 | TIL111SR2M | Surface Mount; Tape and Reel |
| T | TIL111TM | 0.4" Lead Spacing |
| V | TIL111VM | VDE 0884 |
| TV | TIL111TVM | VDE 0884, 0.4" Lead Spacing |
| SV | TIL111SVM | VDE 0884, Surface Mount |
| SR2V | TIL111SR2VM | VDE 0884, Surface Mount, Tape and Reel |

Marking Information



| Definitions | |
|-------------|--|
| 1 | Fairchild logo |
| 2 | Device number |
| 3 | VDE mark (Note: Only appears on parts ordered with VDE option – See order entry table) |
| 4 | One-digit year code, e.g., '3' |
| 5 | Two-digit work week ranging from '01' to '53' |
| 6 | Assembly package code |

*Note – Parts that do not have the 'V' option (see definition 3 above) that are marked with date code '325' or earlier are marked in portrait format.

Carrier Tape Specification

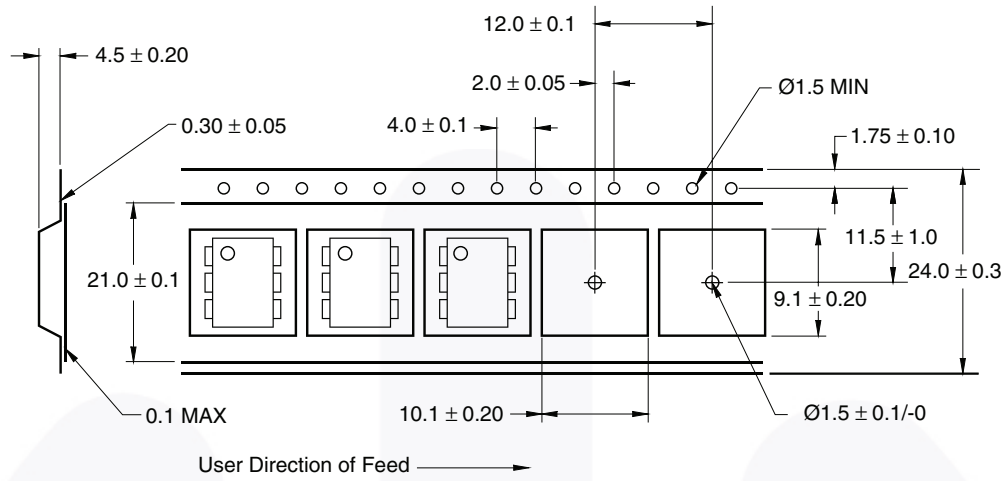

Figure 15. Carrier Tape Specification



NOTES:

- A) NO STANDARD APPLIES TO THIS PACKAGE.
- B) ALL DIMENSIONS ARE IN MILLIMETERS.
- C) DIMENSIONS ARE EXCLUSIVE OF BURRS, MOLD FLASH, AND TIE BAR EXTRUSION
- D) DRAWING FILENAME AND REVISION: MKT-N06BREV4.





LAND PATTERN RECOMMENDATION



NOTES:

- A) NO STANDARD APPLIES TO THIS PACKAGE.
- B) ALL DIMENSIONS ARE IN MILLIMETERS.
- C) DIMENSIONS ARE EXCLUSIVE OF BURRS, MOLD FLASH, AND TIE BAR EXTRUSION
- D) DRAWING FILENAME AND REVISION : MKT-N06CREV4.



ON Semiconductor and  are trademarks of Semiconductor Components Industries, LLC dba ON Semiconductor or its subsidiaries in the United States and/or other countries. ON Semiconductor owns the rights to a number of patents, trademarks, copyrights, trade secrets, and other intellectual property. A listing of ON Semiconductor's product/patent coverage may be accessed at www.onsemi.com/site/pdf/Patent-Marking.pdf. ON Semiconductor reserves the right to make changes without further notice to any products herein. ON Semiconductor makes no warranty, representation or guarantee regarding the suitability of its products for any particular purpose, nor does ON Semiconductor assume any liability arising out of the application or use of any product or circuit, and specifically disclaims any and all liability, including without limitation special, consequential or incidental damages. Buyer is responsible for its products and applications using ON Semiconductor products, including compliance with all laws, regulations and safety requirements or standards, regardless of any support or applications information provided by ON Semiconductor. "Typical" parameters which may be provided in ON Semiconductor data sheets and/or specifications can and do vary in different applications and actual performance may vary over time. All operating parameters, including "Typicals" must be validated for each customer application by customer's technical experts. ON Semiconductor does not convey any license under its patent rights nor the rights of others. ON Semiconductor products are not designed, intended, or authorized for use as a critical component in life support systems or any FDA Class 3 medical devices or medical devices with a same or similar classification in a foreign jurisdiction or any devices intended for implantation in the human body. Should Buyer purchase or use ON Semiconductor products for any such unintended or unauthorized application, Buyer shall indemnify and hold ON Semiconductor and its officers, employees, subsidiaries, affiliates, and distributors harmless against all claims, costs, damages, and expenses, and reasonable attorney fees arising out of, directly or indirectly, any claim of personal injury or death associated with such unintended or unauthorized use, even if such claim alleges that ON Semiconductor was negligent regarding the design or manufacture of the part. ON Semiconductor is an Equal Opportunity/Affirmative Action Employer. This literature is subject to all applicable copyright laws and is not for resale in any manner.

PUBLICATION ORDERING INFORMATION

LITERATURE FULFILLMENT:

Literature Distribution Center for ON Semiconductor
19521 E. 32nd Pkwy, Aurora, Colorado 80011 USA
Phone: 303-675-2175 or 800-344-3860 Toll Free USA/Canada
Fax: 303-675-2176 or 800-344-3867 Toll Free USA/Canada
Email: orderlit@onsemi.com

N. American Technical Support: 800-282-9855 Toll Free
USA/Canada
Europe, Middle East and Africa Technical Support:
Phone: 421 33 790 2910
Japan Customer Focus Center
Phone: 81-3-5817-1050

ON Semiconductor Website: www.onsemi.com
Order Literature: <http://www.onsemi.com/orderlit>
For additional information, please contact your local
Sales Representative

Mouser Electronics

Authorized Distributor

Click to View Pricing, Inventory, Delivery & Lifecycle Information:

[ON Semiconductor:](#)

[TIL117SR2VM](#)

Компания «Life Electronics» занимается поставками электронных компонентов импортного и отечественного производства от производителей и со складов крупных дистрибьюторов Европы, Америки и Азии.

С конца 2013 года компания активно расширяет линейку поставок компонентов по направлению коаксиальный кабель, кварцевые генераторы и конденсаторы (керамические, пленочные, электролитические), за счёт заключения дистрибьюторских договоров

Мы предлагаем:

- Конкуренспособные цены и скидки постоянным клиентам.
- Специальные условия для постоянных клиентов.
- Подбор аналогов.
- Поставку компонентов в любых объемах, удовлетворяющих вашим потребностям.
- Приемлемые сроки поставки, возможна ускоренная поставка.
- Доставку товара в любую точку России и стран СНГ.
- Комплексную поставку.
- Работу по проектам и поставку образцов.
- Формирование склада под заказчика.
- Сертификаты соответствия на поставляемую продукцию (по желанию клиента).
- Тестирование поставляемой продукции.
- Поставку компонентов, требующих военную и космическую приемку.
- Входной контроль качества.
- Наличие сертификата ISO.

В составе нашей компании организован Конструкторский отдел, призванный помогать разработчикам, и инженерам.

Конструкторский отдел помогает осуществить:

- Регистрацию проекта у производителя компонентов.
- Техническую поддержку проекта.
- Защиту от снятия компонента с производства.
- Оценку стоимости проекта по компонентам.
- Изготовление тестовой платы монтаж и пусконаладочные работы.



Тел: +7 (812) 336 43 04 (многоканальный)

Email: org@lifeelectronics.ru