

2461

SourceMeter® SMU Instrument 1000 Watts, 10 Amps Pulse, 7 Amps DC



The Model 2461 High Current SourceMeter® Source Measure Unit (SMU) Instrument brings advanced Touch, Test, Invent® technology right to your fingertips. It combines an innovative graphical user interface (GUI) with capacitive touchscreen technology to make testing intuitive and minimize the learning curve to help engineers and scientists learn faster, work smarter, and invent easier. With its 10A/1000W pulse current and 7A/100W DC current capability combined with dual 18-bit 1MS/s digitizers, the Model 2461 is optimized for characterizing and testing high power materials, devices, and modules, such

as silicon carbide (SiC), gallium nitride (GaN), DC-DC converters, circuit protection devices, solar cells and panels, high brightness LEDs and lighting systems, electro-chemical cells and batteries, and much more. These new capabilities, combined with Keithley's expertise in high precision, high accuracy SMU instruments, will make the Model 2461 a "go-to instrument" for high current sourcing and high speed measurement applications in the lab and in the rack for years to come.

Learn Faster; Work Smarter; Invent Easier

The Model 2461 features a five-inch, full-color, high resolution touchscreen that supports intuitive operation, helps operators become familiar with the instrument quickly, and optimizes overall speed and productivity. A simple icon-based menu structure reduces the number of steps required to configure a test by as much as 50 percent and eliminates the cumbersome multi-layer menu structures typically used on soft-key instruments. Built-in, context-sensitive help supports intuitive operation and minimizes the need to review a separate manual. These capabilities, combined with the Model 2461's high versatility, simplify its operation in both basic and advanced measurement applications, regardless of the user's previous experience in working with SMU instruments.

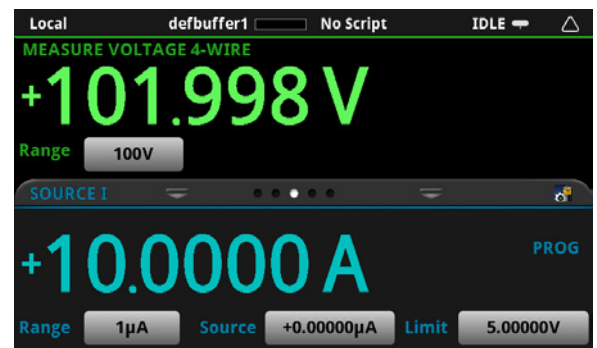

The Model 2461's home screen makes testing intuitive and helps minimize the learning curve for new users.

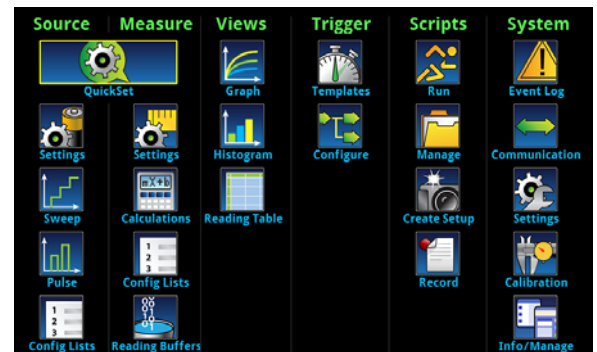

The graphical SMU's icon-based menu structure helps even novice users configure tests quickly and confidently.

- One tightly coupled instrument that combines the capabilities of analyzers, curve tracers, and I-V systems at a fraction of their cost
- Wide coverage up to 105V / 7A DC 100W, 100V / 10A Pulse 1000W max.
- Dual 1MS/s digitizers for fast sampling measurements
- Five-inch, high resolution capacitive touchscreen GUI
- 0.012% DCV accuracy with 6½-digit resolution
- Source and sink (4-quadrant) operation
- Four "Quickset" modes for fast setup and measurements
- Context-sensitive help function
- Front panel input banana jacks; rear panel mass termination screw connections
- SCPI and Test Script Processor (TSP®) programming modes
- Front-panel USB 2.0 memory I/O port for transferring data, test scripts, or test configurations

2461

SourceMeter® SMU Instrument
1000 Watts, 10 Amps Pulse, 7 Amps DC

Ordering Information

| | |
|---------------|---|
| 2461 | 100V, 10A, 1000W SourceMeter Instrument |
| 2461-NFP | 100V, 10A, 1000W SourceMeter Instrument, with No Front Panel |
| 2461-RACK | 100V, 10A, 1000W SourceMeter Instrument, without Handle |
| 2461-NFP-RACK | 100V, 10A, 1000W SourceMeter Instrument, with No Front Panel and No Handle |

Accessories Supplied

| | |
|-----------|---|
| 2460-KIT | Rear Panel Mating Mass Terminated Screw Connector |
| 8608 | High Performance Test Leads |
| USB-B-1 | USB Cable, Type A to Type B, 1m (3.3 ft) |
| CS-1616-3 | Safety Interlock Mating Connector |
| CA-180-3A | TSP-Link/Ethernet Cable |

Documentation CD

2461 QuickStart Guide

Test Script Builder Software
(available at www.tektronix.com)KickStart Startup Software
(available at www.tektronix.com)LabVIEW and IVI Drivers (available
at www.tektronix.com)

Capture Real Device Operation with the Built-in Dual 1MS/sec Digitizers

Capturing and displaying real device operation, waveforms, and transient events just got easier with the Model 2461's digitizing function. The two built-in 1MS/sec, 18-bit digitizers make it possible to acquire both voltage and current waveforms simultaneously without the need to use a separate instrument. The digitizing functions employ the same DC voltage and current measure ranges that the standard A/D converter uses. In addition, the voltage digitizing function uses the same DC voltage 10G Ω input impedance levels to reduce loading significantly on the device under test (DUT).

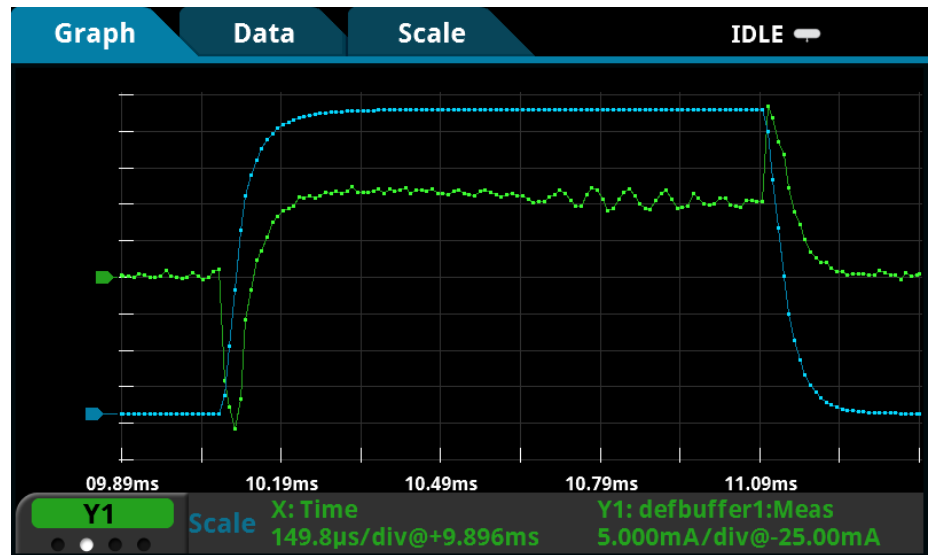

The high speed digitizing function allows capturing and displaying voltage and current measurements simultaneously.

All-in-One SMU Instrument

The Model 2461, part of Keithley's fourth generation of SourceMeter SMUs, leverages the proven capabilities of the original Series 2400 SourceMeter SMU Instruments, such as the Models 2420, 2425, 2430, and 2440. SMU instruments offer a highly flexible, four-quadrant voltage and current source/load coupled with precision voltage and current measurements. This all-in-one instrument offers the capabilities of a:

- Precision power supply with V and I readback
- True current source
- Digital multimeter (DCV, DCI, ohms, and power with 6½-digit resolution)
- Precision electronic load
- Pulse generator
- Trigger controller

2461

SourceMeter® SMU Instrument 1000 Watts, 10 Amps Pulse, 7 Amps DC

| Feature | Model 2461 | Models 2420/2425/2440 | Model 2430 |
|--------------------------|---|------------------------------------|------------------------------------|
| Max Voltage | 100V | 60V/100V/40V | 100V |
| Max DC Current | 7A | 3A/3A/5A | 3A |
| Max Pulse Current | 10A | NA | 10A |
| DC/Pulse Power | 100W/1000W | Up to 100W/NA | 100W/1000W |
| Digitizers | Dual 18-bit 1MS/s | None | None |
| Wideband Noise | <4.5mVrms typ. | 10mVrms typ. | 10mVrms typ. |
| Sweep Types | Linear, Log, Dual Linear, Dual Log, Custom | Linear, Log, Custom, Source-Memory | Linear, Log, Custom, Source-Memory |
| Reading Buffer Size | >2 Million Point Reading Buffer | 5000 Point Reading Buffer | 5000 Point Reading Buffer |
| Programming Command Type | SCPI Programming + TSP Scripting | SCPI | SCPI |
| PC interface | GPIB, USB, Ethernet (LXI) | GPIB, RS-232 | GPIB, RS-232 |
| Signal Input Connections | Front: Banana Jacks Rear: Mass Screw Terminal Connection | Front/Rear Banana Jacks | Front/Rear Banana Jacks |

Comparison of Model 2461 vs. Original Models 2420, 2425, 2430, 2440



2461 Power Envelope

Ease of Use Beyond the Touchscreen

In addition to its five-inch color touchscreen, the 2461 Graphical SourceMeter front panel offers a variety of features that enhance its speed, user-friendliness, and learnability, including a USB 2.0 memory I/O port, a HELP key, a rotary navigation/control knob, a front/rear input selector button, and banana jacks for basic bench applications. The USB 2.0 memory port simplifies storing test results and instrument configurations, uploading test scripts into the instrument, and installing system upgrades. All front-panel buttons are backlit to enhance visibility in low-light environments.

Four “Quickset” modes simplify instrument setup. With one touch, the instrument can be quickly configured for various operating modes without the need to configure the instrument indirectly for this operation.



The Model 2461’s high resolution, capacitive touchscreen and front panel controls allow for intuitive operation, even by novice users.



One-touch Quickset modes speed measurement setups and minimize the time to measurements.

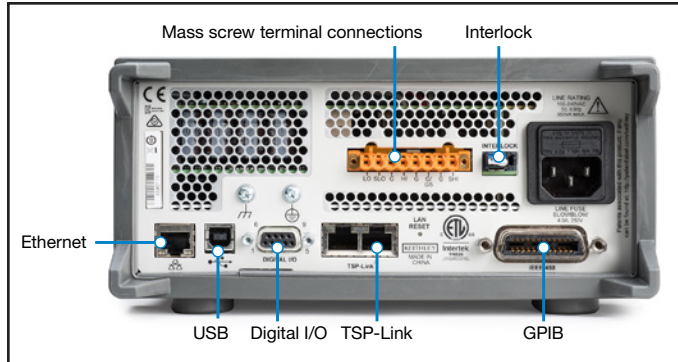

Model 2461 rear panel connections are optimized to maintain signal integrity and speed system setup.

Comprehensive Built-in Connectivity

Rear panel access to rear-input connectors, remote control interfaces (GPIB, USB 2.0, and LXI/Ethernet), D-sub 9-pin digital I/O port (for internal/external trigger signals and handler control), instrument interlock control, and TSP-Link® jacks make it simple to configure multiple instrument test solutions and eliminate the need to invest in additional adapter accessories.

Convert Raw Data to Information

A full graphical plotting window converts raw data and displays it immediately as useful information, such as semiconductor I-V curves and digitized waveforms. The touchscreen interface makes it easy to observe, interact with, and explore measurements with “pinch and zoom” simplicity. By using the built-in graphing cursors, you can immediately analyze your data without a PC. All graphic screens can be saved to a USB thumb drive for incorporation into reports and journals. Using the graphical SMU’s Sheet view, test data can also be displayed in tabular form. The instrument supports exporting data to a spreadsheet for further analysis, dramatically improving productivity for research, benchtop testing, device qualification, and debugging. This combination of high performance and high ease of use offers unparalleled insight into your test results.

TYPICAL APPLICATIONS

Ideal for current/voltage (I-V) characterization and functional test of a wide range of today’s modern electronics and devices, including:

- Power semiconductors and materials
 - SiC, GaN
 - IGBTs, Power MOSFETs
 - HBLEDs
 - Thyristors
- Power management and protection devices
 - Telecom power management chipsets
 - DC-DC converters
 - Metal-oxide varistors (MOV), transient voltage suppressors (TVS)
- Electrochemistry
 - Galvanic cycling
 - Cyclic voltammetry
 - Electro-deposition

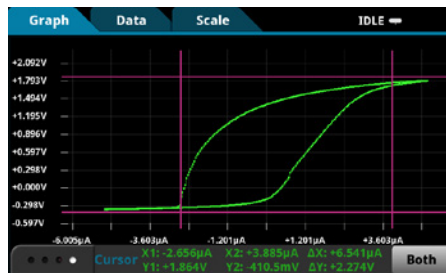
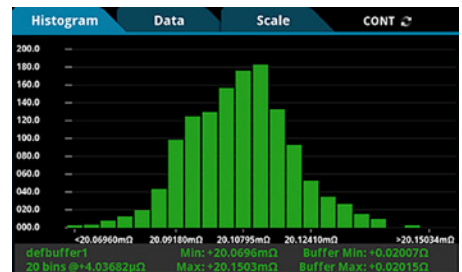
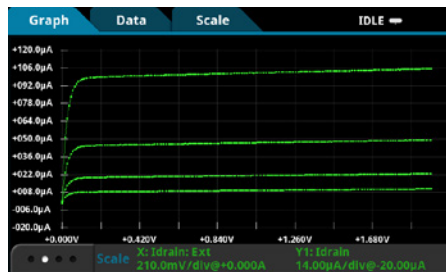
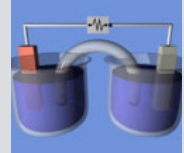
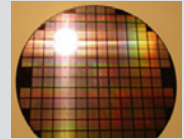

| READING TABLE | | | |
|---------------|-----------------------|-------------|------------|
| Buffer Index | Time | Source | Reading |
| 1 | 04/14 12:56:46.766230 | +6.000000 A | +5.98635 V |
| 2 | 04/14 12:56:46.770194 | +6.000000 A | +5.98594 V |
| 3 | 04/14 12:56:46.774216 | +6.000000 A | +5.98594 V |
| 4 | 04/14 12:56:46.778194 | +6.000000 A | +5.98594 V |
| 5 | 04/14 12:56:46.782211 | +6.000000 A | +5.98580 V |
| 6 | 04/14 12:56:46.786198 | +6.000000 A | +5.98649 V |
| 7 | 04/14 12:56:46.790208 | +6.000000 A | +5.98566 V |
| 8 | 04/14 12:56:46.794203 | +6.000000 A | +5.98484 V |
| 9 | 04/14 12:56:46.798219 | +6.000000 A | +5.98594 V |
| 10 | 04/14 12:56:46.802194 | +6.000000 A | +5.98566 V |

Built-in functions like real-time graphing, charting, scope-like cursors, and data display spreadsheet for export simplify converting test results into useful information.

TriggerFlow® Building Blocks for Instrument Control and Execution

The Model 2461 incorporates Keithley's TriggerFlow triggering system, which provides user control over instrument execution. TriggerFlow diagrams are created in much the same way that flow charts are developed, using four fundamental building block types:

- Wait – Waits for an event to occur before the flow continues
- Branch – Branches when a condition has been satisfied
- Action – Initiates an action in the instrument, for example, measure, source, delay, set digital I/O, etc.
- Notify – Notifies other equipment that an event has occurred

A TriggerFlow model using a combination of these building blocks can be created from the front panel or by sending remote commands. With the TriggerFlow system, users can build triggering models from very simple to complex with up to 255 block levels. The Model 2461 also includes basic triggering functions, including immediate, timer, and manual triggering.

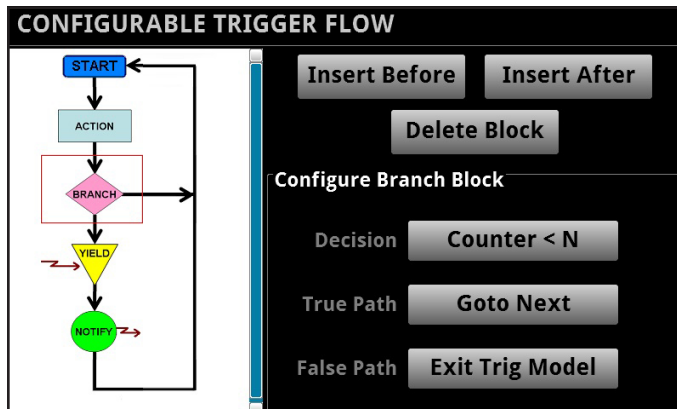

TriggerFlow building blocks allow creating triggering models that range from very simple to highly complex.

Contact Check Function

The Contact Check function makes it simple to verify good connections quickly and easily before an automated test sequence begins. This eliminates measurement errors and false failures associated with contact fatigue, breakage, contamination, loose or broken connection, relay failures, etc. Some capabilities of this function are:

- <100µs verification and notification process time
- 3 pass/fail threshold values: 2Ω, 15Ω, and 50Ω
- Enabled remotely over the GPIB, USB, or Ethernet (LXI) interfaces

Unmatched System Integration and Programming Flexibility

When a Model 2461 is configured into a multi-channel I-V test system, its embedded Test Script Processor (TSP®) allows it to run test scripts, so users can create powerful measurement applications with significantly reduced development times. TSP technology also offers channel expansion without a mainframe. Keithley's TSP-Link® channel expansion bus, which uses a 100 Base T Ethernet cable, can connect multiple graphical SourceMeter SMUs (Model 2450, 2460, 2461), and other TSP instruments such as Keithley's Model DMM7510 7½-Digit Graphical Sampling Multimeter, Series 2600B System SourceMeter SMU instruments, and Series 3700A Switch/Multimeter systems in a master-slave configuration that operates as one integrated system. The TSP-Link expansion bus supports up to 32 units per GPIB or IP address, making it easy to scale a system to fit an application's particular requirements. The Model 2461 also includes a SCPI programming mode that takes advantage of all of the instrument's capabilities.

Parallel Test Capability

The TSP technology in the Model 2461 supports testing multiple devices in parallel to meet the needs of device research, advanced semiconductor lab applications, and even high throughput production test. This parallel testing capability allows each instrument in the system to run its own complete test sequence, creating a fully multi-threaded test environment. The number of tests that can be run in parallel on a graphical SourceMeter can be as high as the number of instruments in the system.

2461

SourceMeter® SMU Instrument

1000 Watts, 10 Amps Pulse, 7 Amps DC

ACCESSORIES AVAILABLE

TEST LEADS AND PROBES

| | |
|------|---|
| 1754 | 2-wire Universal 10-Piece Test Lead Kit |
| 5805 | Kelvin (4-Wire) Spring-Loaded Probes |
| 5808 | Low Cost Single-pin Kelvin Probe Set |
| 5809 | Low Cost Kelvin Clip Lead Set |
| 8605 | High Performance Modular Test Leads |
| 8606 | High Performance Modular Probe Kit |
| 8608 | High Performance Clip Lead Set |

CABLES, CONNECTORS, ADAPTERS

| | |
|-----------|---|
| 2460-BAN | Screw Terminal Connector to Banana Cable |
| 2460-KIT | Mating Mass Termination Connector |
| 8607 | 2-Wire, 1000V Banana Cables, 1m (3.3 ft.) |
| CS-1616-3 | Safety Interlock Mating Connector |

COMMUNICATION INTERFACES & CABLES

| | |
|-------------|--|
| 7007-1 | Shielded GPIB Cable, 1m (3.3 ft) |
| 7007-2 | Shielded GPIB Cable, 1m (6.6 ft) |
| CA-180-3A | CAT5 Crossover Cable for TSP-Link/Ethernet |
| KPCI-488LPA | IEEE-488 Interface for PCI Bus |
| KUSB-488B | IEEE-488 USB-to-GPIB Interface Adapter |
| USB-B-1 | USB Cable, Type A to Type B, 1m (3.3 ft) |

TRIGGERING AND CONTROL

| | |
|------------|---|
| 2450-TLINK | DB-9 to Trigger Link Connector Adapter. |
| 8501-1 | Trigger Link Cable, DIN-to-DIN, 1m (3.3 ft) |
| 8501-2 | Trigger Link Cable, DIN-to-DIN, 2m (6.6 ft) |

RACK MOUNT KITS

| | |
|---------------|--|
| 4299-8 | Single Fixed Rack Mount Kit |
| 4299-9 | Dual Fixed Rack Mount Kit |
| 4299-10 | Dual Fixed Rack Mount Kit. Mount one 2461 and one Series 26xxB |
| 4299-11 | Dual Fixed Rack Mount Kit. Mount one 2461 and one Series 2400, Series 2000, etc. |
| 2450-BenchKit | Ears and Handle for 2461-NFP-RACK and 2461-RACK models |

SERVICES AVAILABLE

| | |
|-----------------|---|
| 2461-3Y-EW | 1 Year Factory Warranty extended to 3 years from date of shipment |
| 2461-5Y-EW | 1 Year Factory Warranty extended to 5 years from date of shipment |
| C/2461-3Y-17025 | KeithleyCare® 3 Year ISO 17025 Calibration Plan |
| C/2461-3Y-DATA | KeithleyCare 3 Year Calibration w/Data Plan |
| C/2461-3Y-STD | KeithleyCare 3 Year Std. Calibration Plan |
| C/2461-5Y-17025 | KeithleyCare 5 Year ISO 17025 Calibration Plan |
| C/2461-5Y-DATA | KeithleyCare 5 Year Calibration w/Data Plan |
| C/2461-5Y-STD | KeithleyCare 5 Year Std. Calibration Plan |
| C/NEW DATA | Calibration Data for New Units |
| C/NEW DATA ISO | ISO-17025 Calibration Data for New Units |

Free Instrument Control Start-up Software

KickStart instrument control/start-up software, available for the Model 2461, lets users start taking measurements in minutes without programming. In most cases, users merely need to make some quick measurements, graph the data, and store the data to disk for later analysis in software environments such as Excel. KickStart offers:

- Instrument configuration control to perform I-V characterization
- Native X-Y graphing, panning, and zooming
- Spreadsheet/tabular viewing of data
- Saving and exporting data for further analysis
- Saving of test setups
- Screenshot capturing of graph
- Annotation of tests
- Command line dialog for sending and receiving data
- HTML help
- GPIB, USB 2.0, Ethernet compliance

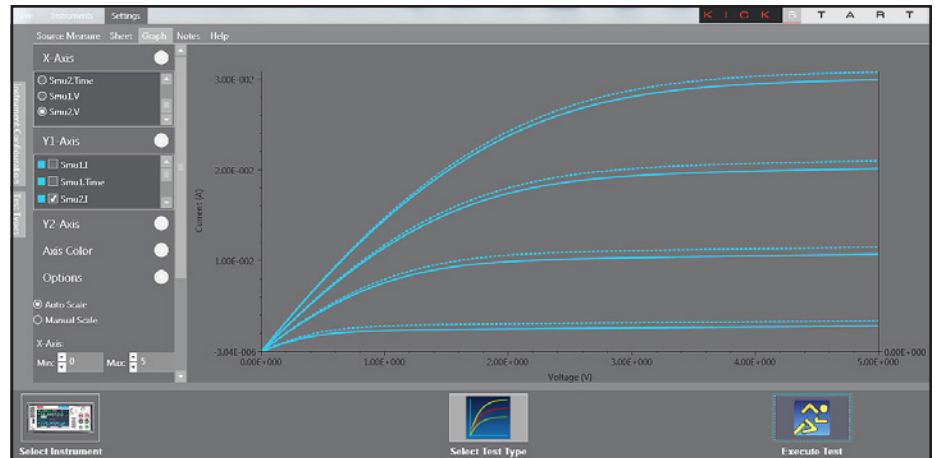

KickStart start-up software lets users be ready to take measurements in minutes.

Simplified Programming with Ready-to-Use Instrument Drivers

For those who prefer to create their own customized application software, native National Instruments LabVIEW® drivers, as well as IVC and IVICOM drivers, are available at www.tektronix.com.

Voltage Specifications ^{1, 2}

| Range | Max. DC Current | Source | | | Measure ³ | | |
|-------------|-----------------|------------|--|---------------------|-------------------------|--|--|
| | | Resolution | Accuracy (23° ±5°C), 1 Year ±(% setting + volts) | Noise (RMS) (<10Hz) | Resolution ⁴ | Accuracy (23° ±5°C), 1 Year ±(% reading + volts) | Digitizer Accuracy ⁵ 23° ±5°C, 1 Week ± (% reading + volts) |
| 200.0000 mV | 7.35 A | 5 µV | 0.015 % + 200 µV | 1 µV | 100 nV | 0.012 % + 200 µV | 0.05 % + 1.2 mV |
| 2.000000 V | 7.35 A | 50 µV | 0.015 % + 300 µV | 2 µV | 1 µV | 0.012 % + 300 µV | 0.05 % + 1.2 mV |
| 7.000000 V | 7.35 A | 250 µV | 0.015 % + 2.4 mV | 20 µV | 1 µV | 0.015 % + 1 mV | 0.05 % + 8 mV |
| 10.00000 V | 5.25 A | 250 µV | 0.015 % + 2.4 mV | 20 µV | 10 µV | 0.015 % + 1 mV | 0.05 % + 8 mV |
| 20.00000 V | 4.20 A | 500 µV | 0.015 % + 2.4 mV | 20 µV | 10 µV | 0.015 % + 1 mV | 0.05 % + 8 mV |
| 100.0000 V | 1.05 A | 2.5 mV | 0.015 % + 15 mV | 200 µV | 100 µV | 0.015 % + 5 mV | 0.05 % + 40 mV |

Measure Input Resistance: >10GΩ all ranges.

Temperature Coefficient: ±(0.10 × accuracy specification)/°C, 0° to 18°C and 28° to 50°C.

Current Specifications ^{1, 2, 6}

| Range | Max. DC Voltage | Source | | | Measure ³ | | |
|-------------------------|-----------------|------------|---|---------------------|-------------------------|---|---|
| | | Resolution | Accuracy (23° ±5°C), 1 Year ±(% setting + amps) | Noise (RMS) (<10Hz) | Resolution ⁴ | Accuracy (23° ±5°C), 1 Year ±(% reading + amps) | Digitizer Accuracy ⁵ 23° ±5°C, 1 Week ± (% reading + amps) |
| 1.000000 µA | 105 V | 50 pA | 0.025 % + 1 nA | 40 pA | 1 pA | 0.025 % + 700 pA | 0.05 % + 4 nA |
| 10.00000 µA | 105 V | 500 pA | 0.025 % + 1.5 nA | 40 pA | 10 pA | 0.025 % + 1 nA | 0.05 % + 8 nA |
| 100.0000 µA | 105 V | 5 nA | 0.020 % + 15 nA | 100 pA | 100 pA | 0.020 % + 10 nA | 0.05 % + 80 nA |
| 1.000000 mA | 105 V | 50 nA | 0.020 % + 150 nA | 1 nA | 1 nA | 0.020 % + 100 nA | 0.05 % + 80 nA |
| 10.00000 mA | 105 V | 500 nA | 0.020 % + 1.5 µA | 10 nA | 10 nA | 0.020 % + 1 µA | 0.05 % + 8 µA |
| 100.0000 mA | 105 V | 5 µA | 0.020 % + 15 µA | 100 nA | 100 nA | 0.020 % + 10 µA | 0.05 % + 80 µA |
| 1.000000 A | 105 V | 50 µA | 0.050 % + 750 µA | 5 µA | 1 µA | 0.050 % + 500 µA | 0.05 % + 1 mA |
| 4.000000 A | 21 V | 250 µA | 0.100 % + 3 mA | 25 µA | 1 µA | 0.100 % + 2.5 mA | 0.10 % + 5 mA |
| 5.000000 A | 10.5 V | 250 µA | 0.100 % + 3 mA | 25 µA | 1 µA | 0.100 % + 2.5 mA | 0.10 % + 5 mA |
| 7.000000 A | 7.35 V | 500 µA | 0.150 % + 6 mA | 125 µA | 1 µA | 0.150 % + 5 mA | 0.15 % + 10 mA |
| 10.00000 A ⁷ | 7.35 V | 500 µA | 0.150 % + 6 mA | 125 µA | 10 µA | 0.150 % + 5 mA | 0.15 % + 10 mA |

Voltage Burden⁸: <100µV all ranges.

Temperature Coefficient: ±(0.10 × accuracy specification)/°C, 0° to 18°C and 28° to 50°C.

1. Speed = 1 PLC.

2. All specifications guaranteed with output ON.

3. Accuracies apply to 2-wire and 4-wire modes when properly zeroed.

4. Measure resolution 6.5 digits. Digitizer resolution limited by noise.

5. 18-bit ADC. Average of 1000 samples taken at 1µs intervals. Internal temperature within ±5°C and 1 week of ACAL.

6. Accuracy specifications guaranteed when using Model 2460-KIT screw terminal accessory for Model 2461.

7. 10A range DC specifications valid up to 7.35A. Operation >7.35A only in pulse mode. Pulse width and duty cycle limits apply. See Pulse Specifications and Typical Pulse Performance sections for more details on pulse operation.

8. 4-wire mode.

Resistance Measurement Accuracy (Local or Remote Sense) ^{9, 10, 11}

| Range | Resolution ¹² | Default Test Current | Normal Accuracy (23°C ±5°C), 1 Year ±(% rdg. + ohms) | Enhanced Accuracy ¹³ (23°C ±5°C), 1 Year ±(% rdg. + ohms) |
|----------------------------|--------------------------|----------------------|--|--|
| <2.000000 Ω ¹⁴ | 1 µΩ | User defined | Source I _{ACC} + Meas. V _{ACC} | Meas. I _{ACC} + Meas. V _{ACC} |
| 2.000000 Ω | 1 µΩ | 100 mA | 0.05 % + 0.003 Ω | 0.04 % + 0.001 Ω |
| 20.00000 Ω | 10 µΩ | 100 mA | 0.05 % + 0.003 Ω | 0.04 % + 0.001 Ω |
| 200.0000 Ω | 100 µΩ | 10 mA | 0.05 % + 0.03 Ω | 0.04 % + 0.01 Ω |
| 2.000000 kΩ | 1 mΩ | 1 mA | 0.05 % + 0.3 Ω | 0.04 % + 0.1 Ω |
| 20.00000 kΩ | 10 mΩ | 100 µA | 0.05 % + 3 Ω | 0.04 % + 1 Ω |
| 200.0000 kΩ | 100 mΩ | 10 µA | 0.05 % + 30 Ω | 0.05 % + 10 Ω |
| 2.000000 MΩ | 1 Ω | 10 µA | 0.06 % + 100 Ω | 0.06 % + 50 Ω |
| 20.00000 MΩ | 10 Ω | 1 µA | 0.14 % + 1 kΩ | 0.12 % + 500 Ω |
| 200.0000 MΩ | 100 Ω | 100 nA | 1.04 % + 10 kΩ | 0.74 % + 5 kΩ |
| >200.0000 MΩ ¹⁴ | — | User defined | Source I _{ACC} + Meas. V _{ACC} | Meas. I _{ACC} + Meas. V _{ACC} |

Temperature Coefficient (0°–18°C and 28°–50°C): ±(0.10 × accuracy specification)/°C.

9. Speed = 1 PLC.

10. All specifications are guaranteed with output ON.

11. Accuracies apply to 2- and 4-wire mode when properly zeroed.

12. 6.5-digit measure resolution.

13. Source readback enabled. Offset compensation ON.

14. Source current, measure resistance or source voltage, measure resistance only.

Source Current, Measure Resistance Mode: Total uncertainty = I_{source} accuracy + V_{measure} accuracy (4-wire remote sense).

Source Voltage, Measure Resistance Mode: Total uncertainty = V_{source} accuracy + I_{measure} accuracy (4-wire remote sense).

Additional Pulse Mode Source Specifications

Minimum Programmable Pulse Width: 150 μ s. **Note:** Time for settling and/or measuring may be longer than 150 μ s.

Maximum Extended Range Pulse Width: 2.5ms for 7A and lower ranges, 1ms for 10A range.

Maximum DC Pulse Width: 10,000 seconds.

Pulse Width Programming Resolution: Variable, limited by Pulse Width and Pulse Width Jitter.

Pulse Width Jitter: <(50 μ s + 10% of pulse width), typical, Acquire Readings = OFF.

Maximum Pulse Duty Cycle: 10% for 20V and lower ranges, 5% for 100V range.

Typical Pulse Performance (Best fixed range, 4W sense)

| Source Value | Limit Range and Value | Load | Rise Time (10% to 90%) | Settling Time (1% of range) |
|--------------|-----------------------|--------------|------------------------|-----------------------------|
| 100 V | 10.5 A | 10 Ω | 300 μ s | 520 μ s |
| 100 V | 1.05 A | 200 Ω | 180 μ s | 320 μ s |
| 20 V | 10 A | 2 Ω | 150 μ s | 340 μ s |
| 10 A | 105 V | 10 Ω | 300 μ s | 700 μ s |
| 7 A | 7.35 V | 1 Ω | 120 μ s | 360 μ s |
| 5 A | 10.5 V | 2 Ω | 110 μ s | 280 μ s |

Contact Check

Contact Check Speed: <100 μ s for verification and notification/

| Resistance Settings | 2 Ω | 15 Ω | 50 Ω |
|------------------------------|---------------|----------------|----------------|
| No contact check failure | <1.0 Ω | <10.0 Ω | <40.0 Ω |
| Always contact check failure | >6.0 Ω | >20.0 Ω | >60.0 Ω |

Digitizer Characteristics

Maximum Resolution: 18 bits.

Available Measurement Functions: Voltage, Current, Simultaneous Voltage and Current, Resistance, Power.

Sampling Rate¹⁵: Programmable 1k through 1 million samples per second.

Volatile Sample Memory With Timestamp: 27.5 million.

Minimum Record Time: 1 μ s.

Timestamp Resolution: 1ns with standard or full buffer style. 1 μ s with compact buffer style.

Maximum Record Length: 5 million.

Range Selection: Fixed-range required for digitizer measurements.

Measurement Settling Time: Range and load dependent. Accuracy limited by settling time for 10mA and lower current ranges.

15. Sample rate is not continuously adjustable. For valid discrete settings, see the Model 2461 Reference Manual.

Supplemental Characteristics

Max. Output Power: 1050W pulse, 105W DC, four quadrant source or sink operation.

Overrange: 105% of range, source and measure.

Regulation: Voltage: Line: 0.01% of range. Load: 0.01% of range + 100 μ V.

Current: Line: 0.01% of range. Load: 0.01% of range + 100pA.

Source Limits:

Voltage Source Current Limit: Bipolar current limit set with single value. Min. 10% of range.

Current Source Voltage Limit: Bipolar voltage limit set with single value. Min. 10% of range.

V/I-Limit Accuracy: Add 0.3% of setting and \pm 0.02% of reading to base specification.

Overshoot:

Voltage Source: <0.1% typical. Step size = Full scale, resistive load, 20V range, 10mA I-limit).

Current Source: <0.1% typical. Step size = 1mA step, R_{load} = 10k Ω , 20V range)

Range Change Overshoot: Overshoot into a fully resistive 100k Ω load, 10Hz to 20MHz bandwidth, adjacent ranges: <250mV typical.

Output Settling Time: Time required to reach within 0.1 % of final value: 20 V range, 100 mA I-limit: <200 μ s typical.

Maximum Slew Rate: 1V per μ s, 100V range, 100mA limit into a 20k Ω load (typical). 0.6V per μ s, 20V range, 100mA limit into a 20k Ω load (typical).

Over Voltage Protection: User selectable values, 5% \pm 0.5V tolerance. Factory default = none.

Voltage Source Noise: 10Hz to 20MHz (RMS):<4.5mV typical into a resistive load.

Common Mode Voltage: 250V DC.

Common Mode Isolation: >1G Ω , <1000pF.

Noise Rejection (Typical):

| NPLC | NMRR | CMRR |
|------|-------|-------|
| 0.01 | - | 60 dB |
| 0.1 | - | 60 dB |
| 1 | 60 dB | 100dB |

Load Impedance:

Normal Mode: 20nF typical.

High Capacitance Mode: Stable into 50 μ F typical. High-capacitance mode valid for \geq 100 μ A ranges.

Max. Voltage Drop Between Force and Sense Terminals: 5V.

Max. Force Lead Voltage Drop: 1V.

Max. Sense Lead Resistance: 1M Ω for rated accuracy.

Sense Input Impedance: >10G Ω .

Guard Offset Voltage: <300 μ V typical.

System Measurement Speeds ¹⁶

Reading rates (readings per second) typical for 60Hz (50Hz), script (TSP®) programmed.

| NPLC | Trigger Origin | Measure to Memory | Measure to GPIB/USB/LAN | Source Measure to Memory | Source Measure to GPIB/USB/LAN |
|-----------|----------------|-------------------|-------------------------|--------------------------|--------------------------------|
| 0.01 NPLC | Internal | 3050 (2800) | 2800 (2500) | 1700 (1600) | 1650 (1550) |
| 0.01 NPLC | External | 2300 (2100) | 2150 (2000) | 1650 (1550) | 1600 (1450) |
| 0.1 NPLC | Internal | 540 (460) | 530 (450) | 470 (410) | 470 (400) |
| 0.1 NPLC | External | 500 (420) | 500 (420) | 460 (390) | 450 (350) |
| 1 NPLC | Internal | 59 (49) | 59 (49) | 58 (48) | 58 (48) |
| 1 NPLC | External | 58 (48) | 58 (48) | 57 (48) | 57 (46) |

Reading rates (readings per second) typical for 60Hz (50Hz), SCPI programmed.

| NPLC | Trigger Origin | Measure to Memory | Measure to GPIB/USB/LAN | Source Measure to Memory | Source Measure to GPIB/USB/LAN |
|-----------|----------------|-------------------|-------------------------|--------------------------|--------------------------------|
| 0.01 NPLC | Internal | 3000 (2800) | 3000 (2790) | 1700 (1600) | 1550 (1500) |
| 0.01 NPLC | External | 2330 (2150) | 2330 (2150) | 1650 (1550) | 1500 (1450) |
| 0.1 NPLC | Internal | 540 (460) | 540 (460) | 470 (410) | 460 (400) |
| 0.1 NPLC | External | 510 (430) | 510 (430) | 470 (400) | 460 (390) |
| 1 NPLC | Internal | 59 (49) | 59 (49) | 58 (48) | 58 (48) |
| 1 NPLC | External | 58 (49) | 58 (49) | 58 (48) | 58 (48) |

16. Reading rates applicable for voltage or current measurements, autozero off, autorange off, filter off, binary reading format, and source readback off.

Digitize, Typical

| Sampling Rate | Digits | Resolution, bits | Measure to USB |
|---------------|--------|------------------|-------------------|
| 10 kS/s | 5½ | 18 | Up to 10 kS/s |
| 20 kS/s | 4½ | 16 | Up to 20 kS/s |
| 50 kS/s | 4½ | 16 | Up to 50 kS/s |
| 100 kS/s | 4½ | 15 | Up to 100 kS/s |
| 1 MS/s | 3½ | 12 | At least 100 kS/s |

SCPI Programmed. Buffer style is compact.

General Characteristics (default mode unless specified)

Factory Default Standard Power-Up: SCPI Mode.

Source Output Modes: Fixed DC Level, Memory/Configuration List (mixed function), Sweep (linear and log), Sweep (dual linear and dual log).

Memory Buffer: >2 million readings, user adjustable. Includes selected measured value(s) and time stamp.

Real-Time Clock: Lithium battery backup (3 yr. + battery life).

Remote Interfaces:

GPIB: IEEE-488.2.

USB Device (rear panel, type B): 2.0 Full Speed USBTMC.

USB Device (front panel, type A): USB 2.0, support for thumb drives.

Ethernet: RJ-45 (10/100BT)

Digital I/O Interface:

Lines: 6 input/output, user defined, for digital I/O or triggering.

Connector: 9-pin female D.

Input Signal Levels: 0.7V (maximum logic low), 3.7V (minimum logic high).

Input Voltage Limits: -0.25V (absolute minimum), +5.25V (absolute maximum).

Maximum Source Current: +2.0mA @ >2.7V (per pin).

Maximum Sink Current: -50mA @ 0.7V (per pin, solid-state fuse protected).

5V Power Supply Pin: Limited to 500mA @ >4V (solid-state fuse protected).

Handler Interface: Start of test, end of test, 4 category bits.

Programmability: SCPI or TSP command sets.

TSP Mode: Embedded Test Script Processor (TSP) accessible from any host interface.

IP Configuration: Static or DHCP.

Expansion Interface: The TSP-Link expansion interface allows TSP enabled instruments to trigger and communicate with each other.

LXI Compliance: 1.4 LXI Core 2011.

Display: Five-inch capacitive touch, color TFT WVGA (800×480) with LED backlight.

Input Signal Connections: Front: Banana. **Rear:** Mass termination screw terminal.

Interlock: Active high-input.

Cooling: Forced air, variable speed.

Over Temperature Protection: Internally sensed temperature overload puts unit in standby mode.

Power Supply: 100V to 240V RMS, 50–60Hz (automatically detected at power up).

VA Rating: 350 volt-amps max.

Altitude: Maximum 2000 meters (6562 feet) above sea level.

EMC: Conforms to European Union EMC Directive.

Safety: Compliance with CE and NRTL listed to UL61010-1 and UL61010-2-30. Conforms with European Union Low Voltage Directive.

Vibration: MIL-PRF-28800F Class 3 Random.

Warm-Up: 1 hour to rated accuracies.

DIMENSIONS:

With handle and bumpers: 106mm high × 255mm wide × 425mm deep (4.18 in × 10.05 in × 16.75 in).

Without handle and bumpers: 88mm high × 213mm wide × 397mm deep (3.46 in × 8.39 in × 15.63 in.)

WEIGHT: With bumpers and handle: 4.75 kg (10.5 lbs.).

Without bumpers and handle: 4.55 kg (10.0 lbs.).

ENVIRONMENT: Operating: 0°–50°C, 70% R.H. up to 35°C. Derate 3% R.H./°C, 35°–50°C, non-condensing. **Storage:** -25°C to 65°C.

Contact Information:

ASEAN / Australia (65) 6356 3900
Austria 00800 2255 4835
Balkans, Israel, South Africa and other ISE Countries +41 52 675 3777
Belgium 00800 2255 4835
Brazil +55 (11) 3759 7627
Canada 1 800 833 9200
Central East Europe and the Baltics +41 52 675 3777
Central Europe & Greece +41 52 675 3777
Denmark +45 80 88 1401
Finland +41 52 675 3777
France 00800 2255 4835
Germany 00800 2255 4835
Hong Kong 400 820 5835
India 000 800 650 1835
Italy 00800 2255 4835
Japan 81 (3) 6714 3010
Luxembourg +41 52 675 3777
Mexico, Central/South America & Caribbean 52 (55) 56 04 50 90
Middle East, Asia, and North Africa +41 52 675 3777
The Netherlands 00800 2255 4835
Norway 800 16098
People's Republic of China 400 820 5835
Poland +41 52 675 3777
Portugal 80 08 12370
Republic of Korea 001 800 8255 2835
Russia & CIS +7 (495) 6647564
South Africa +41 52 675 3777
Spain 00800 2255 4835
Sweden 00800 2255 4835
Switzerland 00800 2255 4835
Taiwan 886 (2) 2656 6688
United Kingdom & Ireland 00800 2255 4835
USA 1 800 833 9200

Rev 0415

For Further Information

Tektronix maintains a comprehensive, constantly expanding collection of application notes, technical briefs and other resources to help engineers working on the cutting edge of technology. Visit www.tektronix.com or www.keithley.com.

Copyright © 2015, Tektronix. All rights reserved. Tektronix products are covered by U.S. and foreign patents, issued and pending. Information in this publication supersedes that in all previously published material. Specification and price change privileges reserved. TEKTRONIX and TEK are registered trademarks of Tektronix, Inc. All other trade names referenced are the service marks, trademarks or registered trademarks of their respective companies.

1120a15 KI

1KW-60288-0

KEITHLEY
A Tektronix Company

Компания «Life Electronics» занимается поставками электронных компонентов импортного и отечественного производства от производителей и со складов крупных дистрибьюторов Европы, Америки и Азии.

С конца 2013 года компания активно расширяет линейку поставок компонентов по направлению коаксиальный кабель, кварцевые генераторы и конденсаторы (керамические, пленочные, электролитические), за счёт заключения дистрибьюторских договоров

Мы предлагаем:

- Конкурентоспособные цены и скидки постоянным клиентам.
- Специальные условия для постоянных клиентов.
- Подбор аналогов.
- Поставку компонентов в любых объемах, удовлетворяющих вашим потребностям.
- Приемлемые сроки поставки, возможна ускоренная поставка.
- Доставку товара в любую точку России и стран СНГ.
- Комплексную поставку.
- Работу по проектам и поставку образцов.
- Формирование склада под заказчика.
- Сертификаты соответствия на поставляемую продукцию (по желанию клиента).
- Тестирование поставляемой продукции.
- Поставку компонентов, требующих военную и космическую приемку.
- Входной контроль качества.
- Наличие сертификата ISO.

В составе нашей компании организован Конструкторский отдел, призванный помогать разработчикам, и инженерам.

Конструкторский отдел помогает осуществить:

- Регистрацию проекта у производителя компонентов.
- Техническую поддержку проекта.
- Защиту от снятия компонента с производства.
- Оценку стоимости проекта по компонентам.
- Изготовление тестовой платы монтаж и пусконаладочные работы.



Тел: +7 (812) 336 43 04 (многоканальный)

Email: org@lifeelectronics.ru