

High surge voltage 1.25 A SCR for circuit breaker

Datasheet - production data

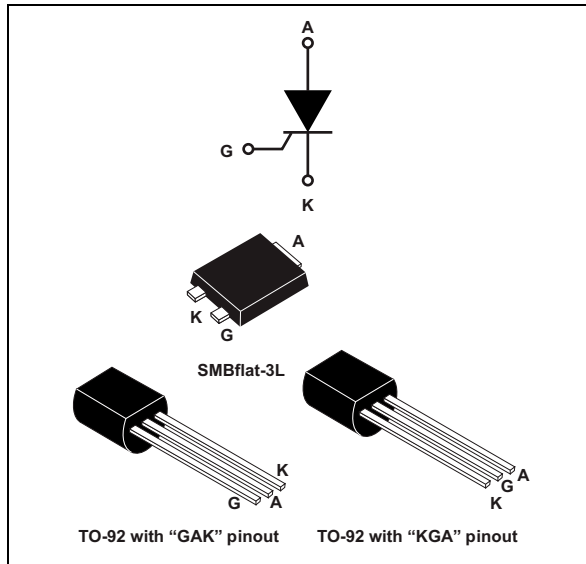

Description

Thanks to highly sensitive triggering levels, the TS110-8 series is suitable for circuit breaker applications where the available gate current is limited.

The 1250 V direct surge voltage capability of the TS110-8 enables high robustness of the whole circuit breaker. The low leakage current of the TS110-8 reduces power consumption over the entire lifetime of the circuit breaker. The high off-state immunity (200 V/μs) insures the non tripping of the breaker in case of electrical fast transient (EFT) on the mains.

The TS110-8 is available in through-hole TO-92 package with GAK and KGA pinout and in SMBflat-3L package.

Features

- On-state rms current, 1.25 A
- Repetitive peak off-state voltage, 800 V
- Non-repetitive direct surge peak off-state voltage, 1250 V
- Non-repetitive reverse surge peak off-state voltage, 900 V
- Triggering gate current, 100 μA
- High off-state immunity: 200 V/μs
- ECOPACK[®]2 compliant component

Table 1. Device summary

Symbol	Value	Unit
$I_{T(RMS)}$	1.25	A
V_{DRM}, V_{RRM}	800	V
V_{DSM}, V_{RSM}	1250, 900	V
I_{GT}	100	μA
T_j	125	°C

Applications

- GFCI (Ground Fault Circuit Interrupter)
- AFCI (Arc Fault Circuit Interrupter)
- RCD (Residual Current Device)
- RCBO (Residual Current circuit Breaker with Overload protection)
- AFDD (Arc Fault Detection Device)

1 Characteristics

Table 2. Absolute ratings (limiting values)

Symbol	Parameter		Value	Unit	
$I_{T(RMS)}$	On-state rms current (180° conduction angle)	TO-92	$T_j = 53\text{ °C}$	1.25	A
		SMBflat-3L	$T_c = 109\text{ °C}$		
$I_{T(AV)}$	Average on-state current (180° conduction angle)	TO-92	$T_j = 53\text{ °C}$	0.8	A
		SMBflat-3L	$T_c = 109\text{ °C}$		
I_{TSM}	Non repetitive surge peak on-state current	$t_p = 8.3\text{ ms}$	$T_{j\text{ initial}} = 25\text{ °C}$	21	A
		$t_p = 10\text{ ms}$		20	
	1st step: one surge every 5 seconds, 25 surges 2nd step: one surge every 5 seconds, 25 surges	$t_p = 10\text{ ms}$	$T_{amb} = 90\text{ °C}$	25 times 12 A 25 times 16 A	
I^2t	I^2t Value for fusing	$t_p = 10\text{ ms}, 25\text{ °C}$		2	A ² s
dI/dt	Critical rate of rise of on-state current $I_G = 2 \times I_{GT}, t_r \leq 100\text{ ns}$	F = 50 Hz, 125 °C		100	A/μs
	Non repetitive critical current rate of rise at break-over, see Figure 17 , $V_D > V_{DSM}$			200	
V_{DRM}, V_{RRM}	Repetitive peak off-state AC voltage, $R_{GK} = 220\ \Omega$		$T_j = 125\text{ °C}$	800	V
V_{DSM}	Non-repetitive direct surge peak off-state voltage, $R_{GK} = 220\ \Omega$	$t_p = 10\text{ ms}$	$T_j = 25\text{ °C}$	1250	V
V_{RSM}	Non-repetitive reverse surge peak off-state voltage, $R_{GK} = 220\ \Omega$	$t_p = 10\text{ ms}$	$T_j = 25\text{ °C}$	900	V
I_{GM}	Peak gate current	$t_p = 20\ \mu\text{s}$	$T_j = 125\text{ °C}$	1.2	A
$P_{G(AV)}$	Average gate power dissipation		$T_j = 125\text{ °C}$	0.2	W
T_{stg}	Storage junction temperature range			- 40 to + 150	°C
T_j	Operating junction temperature range			- 40 to + 125	

Table 3. Electrical characteristics

Symbol	Test conditions		Value	Unit	
I_{GT}	$V_D = 12\text{ V}, R_L = 140\ \Omega$	$T_j = 25\text{ °C}$	Min.	1	μA
			Max.	100	
V_{GT}			Max.	0.8	V
V_{GD}	$V_D = V_{DRM}, R_L = 33\text{ k}\Omega, R_{GK} = 220\ \Omega$	$T_j = 125\text{ °C}$	Min.	0.1	V
V_{RG}	$I_{RG} = 2\text{ mA}$	$T_j = 25\text{ °C}$	Min.	7.5	V
I_H	$I_T = 50\text{ mA}, R_{GK} = 220\ \Omega$	$T_j = 25\text{ °C}$	Max.	12	mA
I_L	$I_G = 5\text{ mA}, R_{GK} = 220\ \Omega$	$T_j = 25\text{ °C}$	Max.	12	mA
dV/dt	$V_D = 67\% V_{DRM}, R_{GK} = 220\ \Omega$	$T_j = 125\text{ °C}$	Min.	200	V/μs

Table 4. Static electrical characteristics

Symbol	Test conditions		Value	Unit
V_{TM}	$I_{TM} = 2.5 \text{ A}$, $t_p = 380 \mu\text{s}$	$T_j = 25 \text{ }^\circ\text{C}$	Max. 1.6	V
V_{T0}	Threshold voltage	$T_j = 125 \text{ }^\circ\text{C}$	Max. 0.95	V
R_D	Dynamic resistance	$T_j = 125 \text{ }^\circ\text{C}$	Max. 220	m Ω
I_{DRM} I_{RRM}	$V_D = V_{DRM} / V_{RRM}$, $R_{GK} = 220 \Omega$	$T_j = 25 \text{ }^\circ\text{C}$	Max. 1	μA
		$T_j = 125 \text{ }^\circ\text{C}$	Max. 100	μA

Table 5. Thermal resistance

Symbol	Parameter		Value	Unit
$R_{th(j-l)}$	Junction to leads (DC)		TO-92	65
$R_{th(j-a)}$	Junction to ambient (DC)		TO-92	160
		$S = 5 \text{ cm}^2$	SMBflat-3L	75
$R_{th(j-c)}$	Junction to case (DC)		SMBflat-3L	14

Figure 1. Maximum average power dissipation versus average on-state current

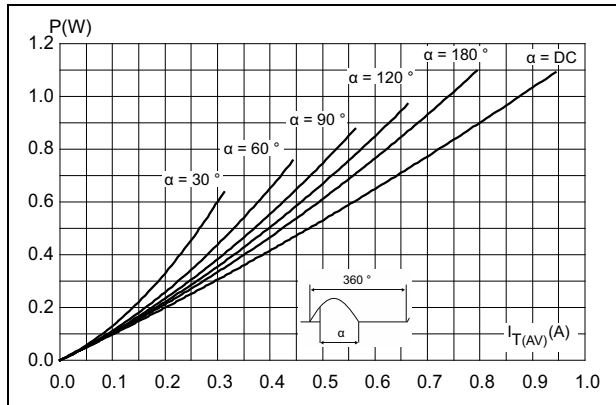

Figure 2. Average and DC on-state current versus lead temperature (TO-92)

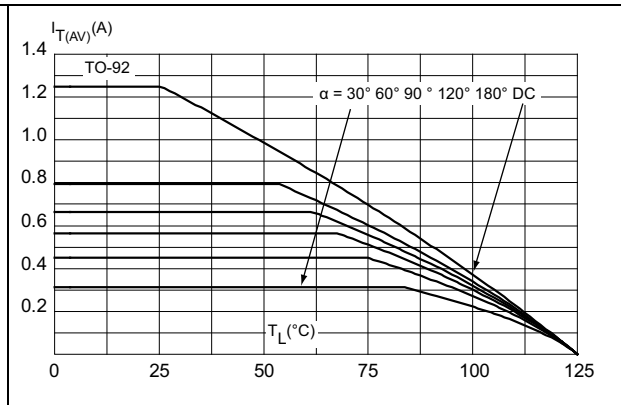

Figure 3. Average and DC on-state current versus case temperature (SMBflat-3L)

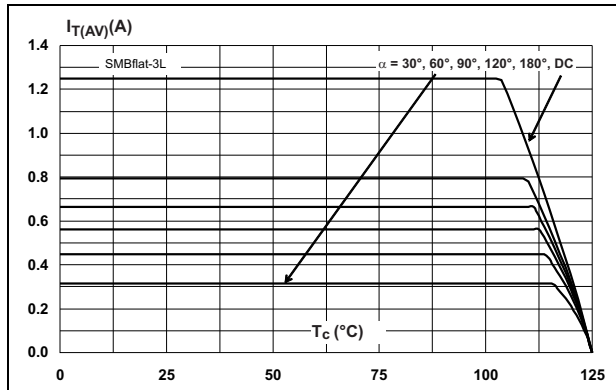

Figure 4. Average and DC on-state current versus ambient temperature

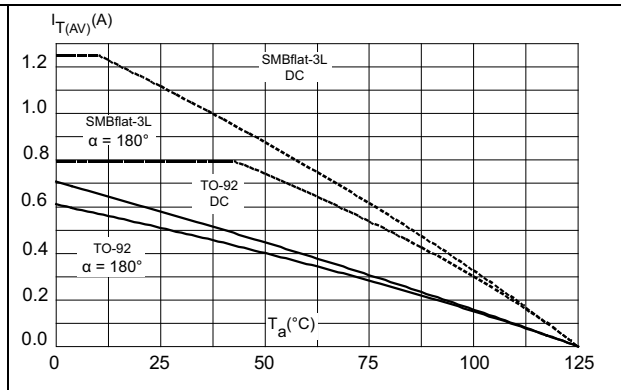

Figure 5. Relative variation of thermal impedance junction to ambient versus pulse duration

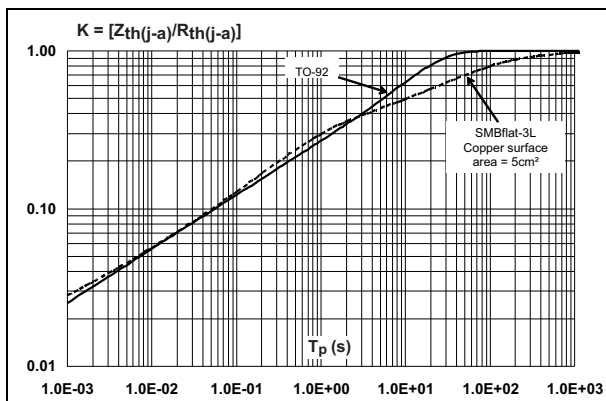

Figure 6. Typical thermal resistance junction to ambient versus copper surface under anode (epoxy FR4, $Cu_{th} = 35 \mu m$)

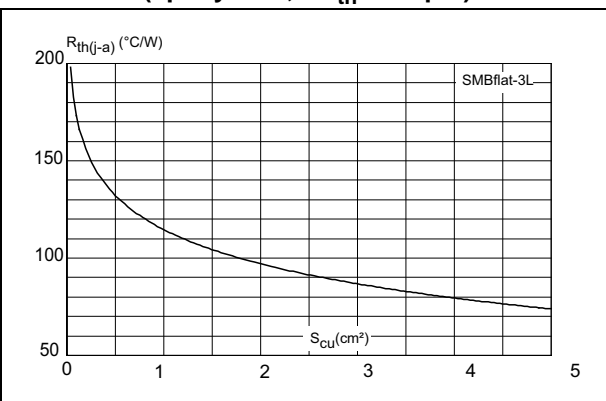

Figure 7. Relative variation of gate trigger current and trigger voltage versus junction temperature (typical values)

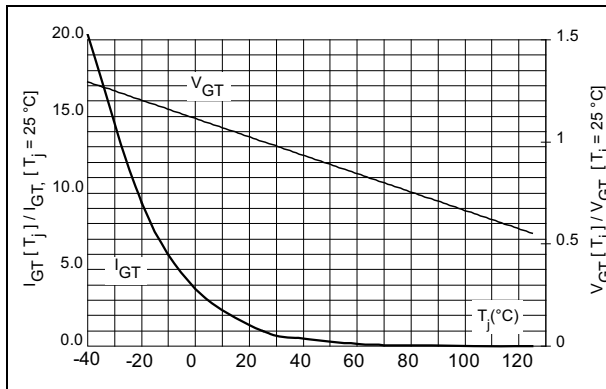

Figure 8. Relative variation of latching and holding current versus junction temperature (typical values)

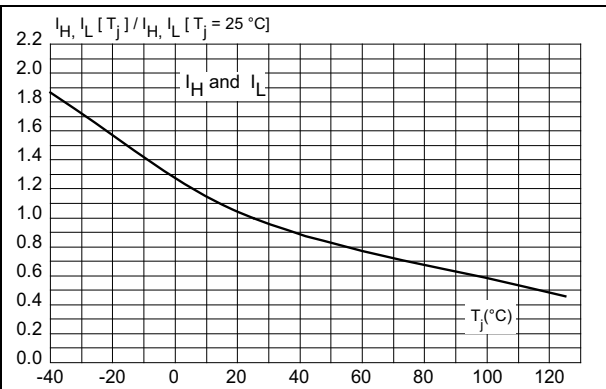

Figure 9. Relative variation of holding current versus gate-cathode resistance (typical values)

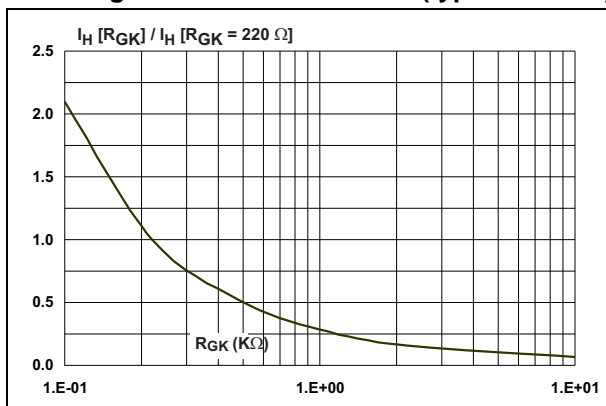

Figure 10. Relative variation of dV/dt immunity versus junction temperature (typical values)

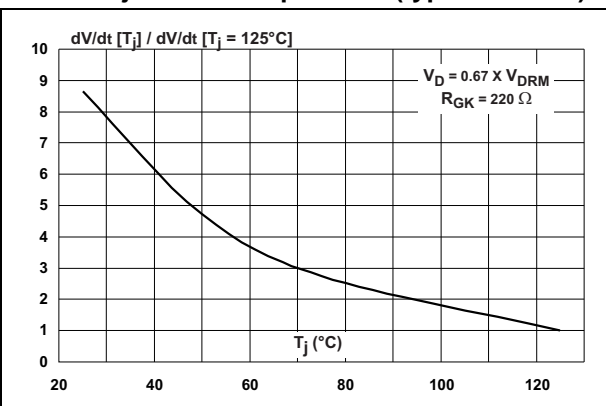

Figure 11. Relative variation of dV/dt immunity versus gate-cathode resistance (typical values)

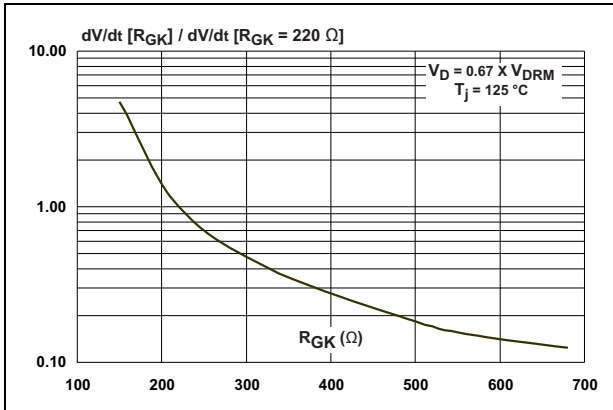

Figure 12. Relative variation of dV/dt immunity versus gate-cathode capacitor (typical values)

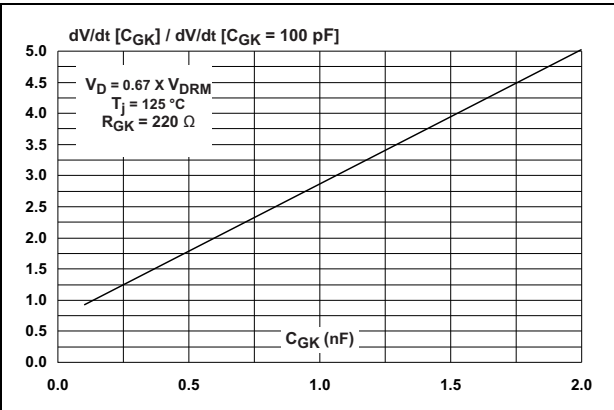

Figure 13. On-state characteristics (maximum values)

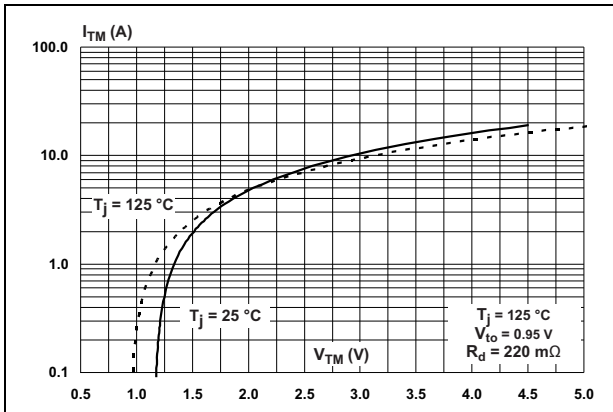

Figure 14. Surge peak on-state current versus number of cycles

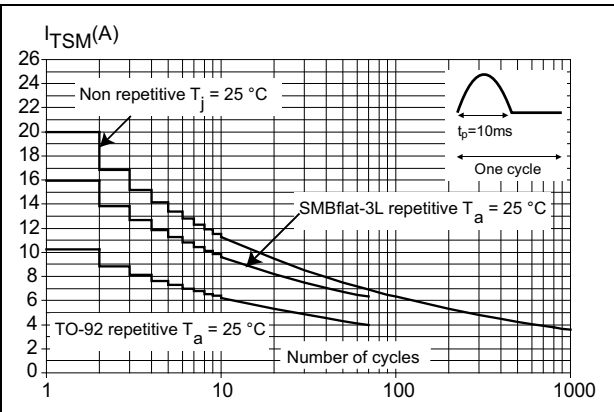
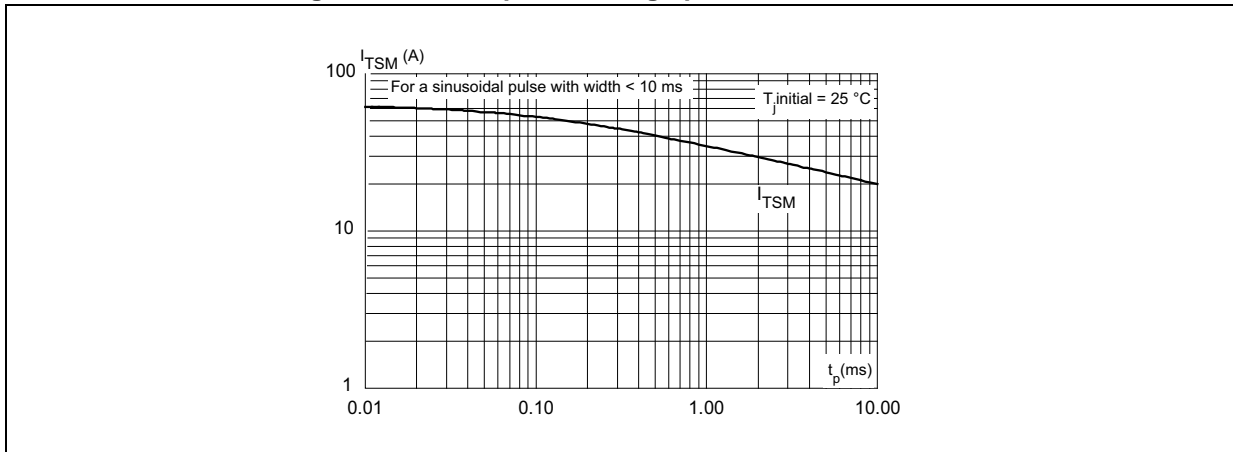

Figure 15. Non repetitive surge peak on-state current



2 AC line transient voltage ruggedness

In comparison with standard SCRs, the TS110-8 is self-protected against over-voltage. The TS110-8 switch can safely withstand AC line direct surge voltages by switching to the on state (for less than 10 ms on 50 Hz mains) to dissipate energy shocks through the load. The load limits the current through the TS110-8. The self-protection against over-voltage is based on an overvoltage crowbar technology. This safety feature works even with high turn-on current ramp up.

Figure 16 represents the TS110-8 in a test environment. It is used to stress the TS110-8 switch according to the IEC 61000-4-5 standard conditions. The TS110-8 folds back safely to the on state as shown in Figure 17.

The TS110-8 recovers its blocking voltage capability after the direct surge and the next zero current crossing. Such a non repetitive test can be done at least 10 times.

Figure 16. Overvoltage ruggedness test circuit for IEC 61000-4-5 standards

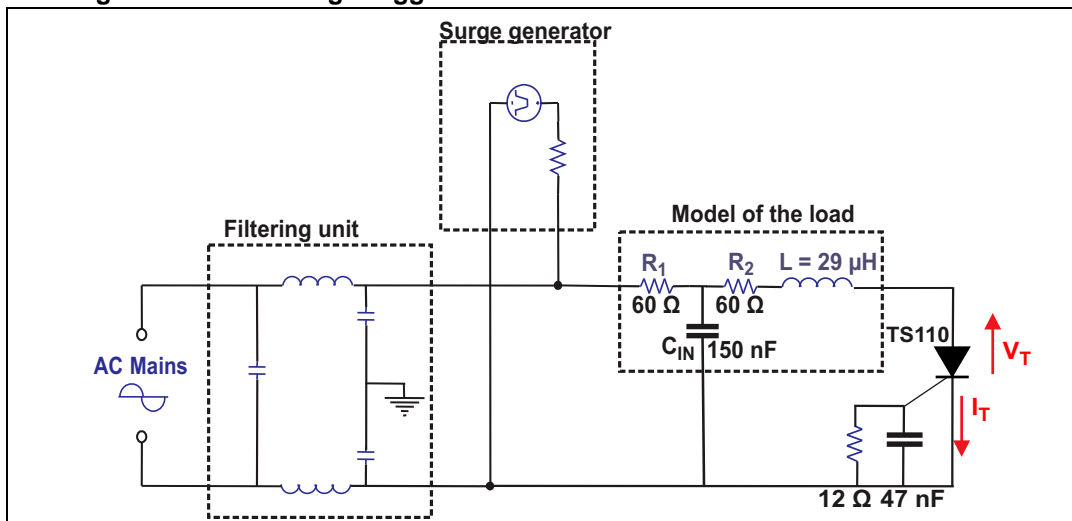
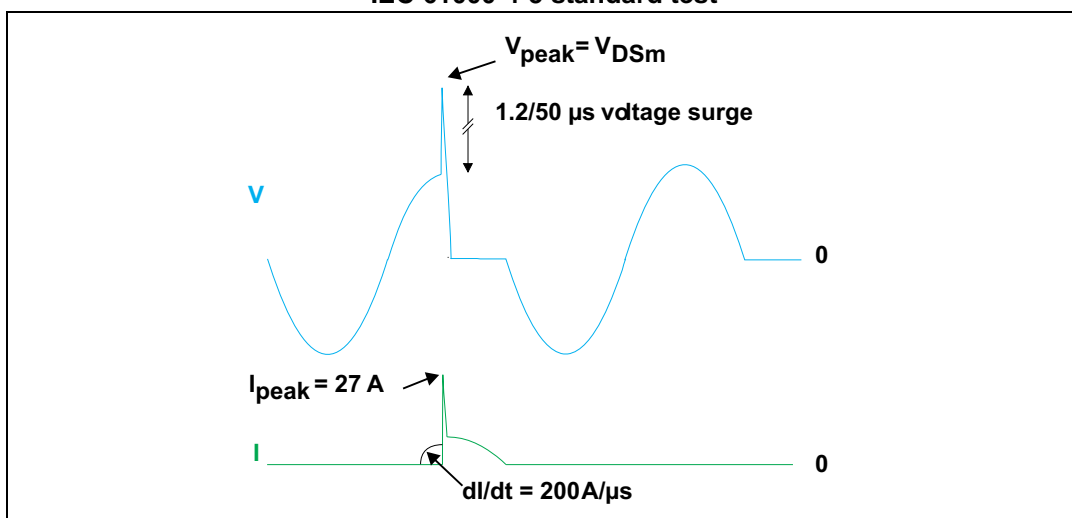

Figure 17. Typical current and voltage waveforms across the TS110-8 during IEC 61000-4-5 standard test



3 Package information

- Epoxy meets UL94, V0
- Lead-free package

In order to meet environmental requirements, ST offers these devices in different grades of ECOPACK[®] packages, depending on their level of environmental compliance. ECOPACK[®] specifications, grade definitions and product status are available at: www.st.com. ECOPACK[®] is an ST trademark.

Figure 18. TO-92 dimensions (definitions)

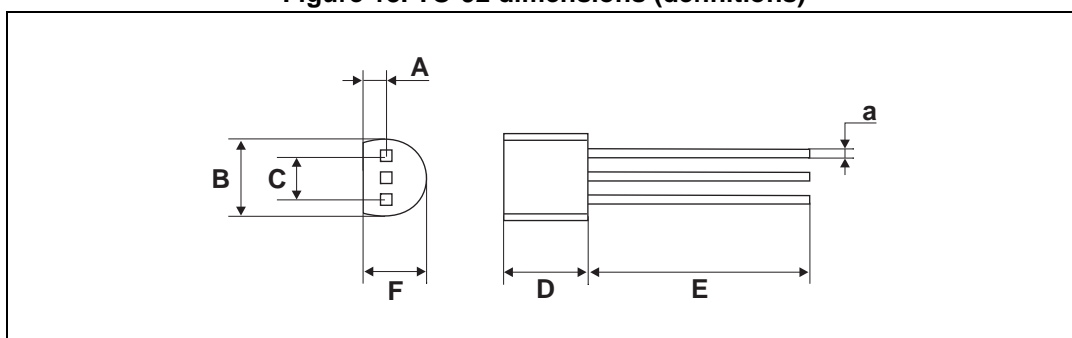

Table 6. TO-92 dimensions (values)

Ref.	Dimensions					
	Millimeters			Inches		
	Min.	Typ.	Max.	Min.	Typ.	Max.
A		1.35			0.053	
B			4.70			0.185
C		2.54			0.100	
D	4.40			0.173		
E	12.70			0.500		
F			3.70			0.146
a			0.5			0.019

For ammpack packing information, please contact your sales representative.

Figure 19. SMBflat-3L dimensions (definitions)

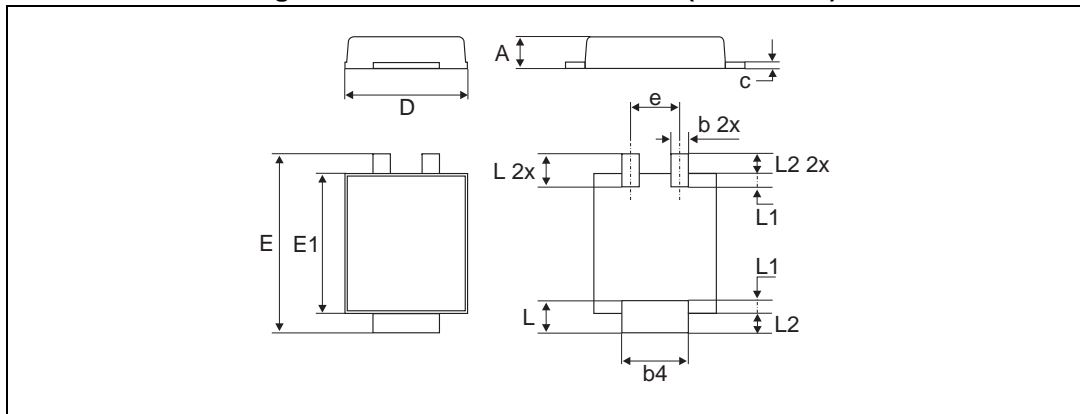
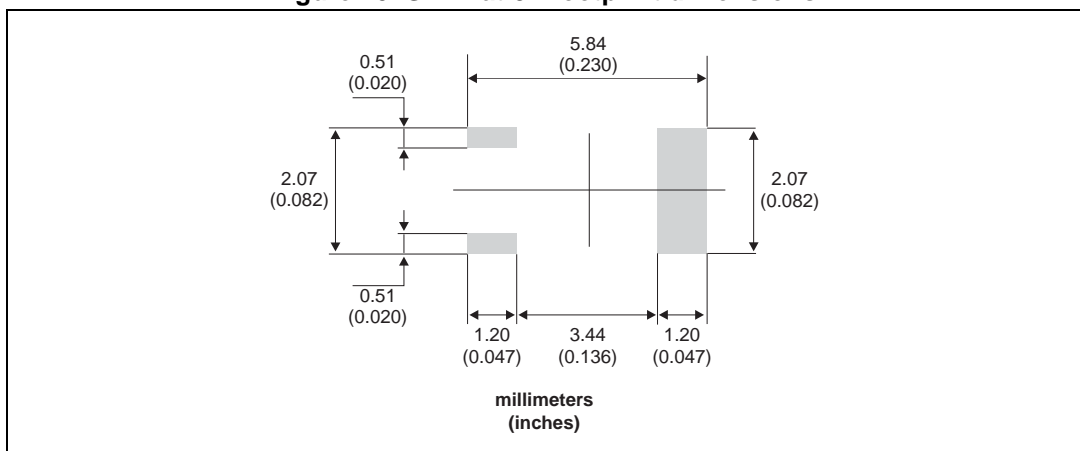

Table 7. SMBflat-3L dimensions (values)

Ref.	Dimensions					
	Millimeters			Inches		
	Min.	Typ.	Max.	Min.	Typ.	Max.
A	0.90		1.10	0.035		0.043
b	0.35		0.65	0.014		0.026
b4	1.95		2.20	0.07		0.087
c	0.15		0.40	0.006		0.016
D	3.30		3.95	0.130		0.156
E	5.10		5.60	0.201		0.220
E1	4.05		4.60	0.156		0.181
L	0.75		1.50	0.030		0.059
L1		0.40			0.016	
L2		0.60			0.024	
e		1.60			0.063	

Figure 20. SMBflat-3L footprint dimensions



4 Ordering information

Figure 21. Ordering information scheme

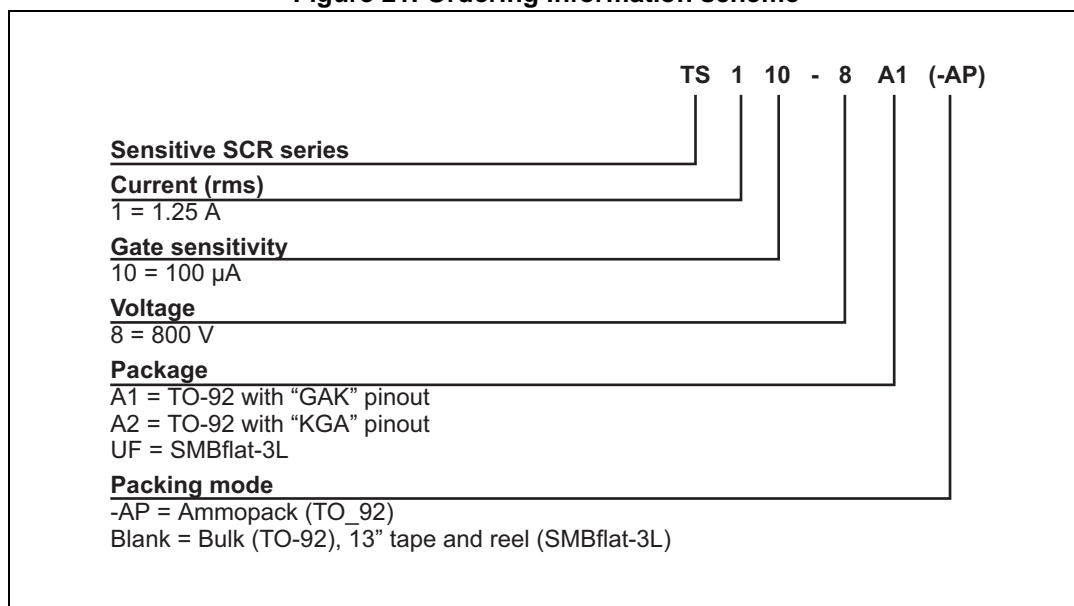

Table 8. Ordering information

Order code	Marking	Package	Weight	Base qty.	Delivery mode
TS110-8A1	TS110-8	TO-92	200 mg	2500	Bulk
TS110-8A1-AP	TS110-8			2000	Ammopack
TS110-8A2	TS110-8	TO-92	200 mg	2500	Bulk
TS110-8A2-AP	TS110-8			2000	Ammopack
TS110-8UF	TS110-8	SMBflat-3L	47 mg	5000	Tape and reel 13"

5 Revision history

Table 9. Document revision history

Date	Revision	Changes
13-Oct-2014	1	Initial release.

IMPORTANT NOTICE – PLEASE READ CAREFULLY

STMicroelectronics NV and its subsidiaries ("ST") reserve the right to make changes, corrections, enhancements, modifications, and improvements to ST products and/or to this document at any time without notice. Purchasers should obtain the latest relevant information on ST products before placing orders. ST products are sold pursuant to ST's terms and conditions of sale in place at the time of order acknowledgement.

Purchasers are solely responsible for the choice, selection, and use of ST products and ST assumes no liability for application assistance or the design of Purchasers' products.

No license, express or implied, to any intellectual property right is granted by ST herein.

Resale of ST products with provisions different from the information set forth herein shall void any warranty granted by ST for such product.

ST and the ST logo are trademarks of ST. All other product or service names are the property of their respective owners.

Information in this document supersedes and replaces information previously supplied in any prior versions of this document.

© 2014 STMicroelectronics – All rights reserved

Компания «Life Electronics» занимается поставками электронных компонентов импортного и отечественного производства от производителей и со складов крупных дистрибьюторов Европы, Америки и Азии.

С конца 2013 года компания активно расширяет линейку поставок компонентов по направлению коаксиальный кабель, кварцевые генераторы и конденсаторы (керамические, пленочные, электролитические), за счёт заключения дистрибьюторских договоров

Мы предлагаем:

- Конкурентоспособные цены и скидки постоянным клиентам.
- Специальные условия для постоянных клиентов.
- Подбор аналогов.
- Поставку компонентов в любых объемах, удовлетворяющих вашим потребностям.
- Приемлемые сроки поставки, возможна ускоренная поставка.
- Доставку товара в любую точку России и стран СНГ.
- Комплексную поставку.
- Работу по проектам и поставку образцов.
- Формирование склада под заказчика.
- Сертификаты соответствия на поставляемую продукцию (по желанию клиента).
- Тестирование поставляемой продукции.
- Поставку компонентов, требующих военную и космическую приемку.
- Входной контроль качества.
- Наличие сертификата ISO.

В составе нашей компании организован Конструкторский отдел, призванный помогать разработчикам, и инженерам.

Конструкторский отдел помогает осуществить:

- Регистрацию проекта у производителя компонентов.
- Техническую поддержку проекта.
- Защиту от снятия компонента с производства.
- Оценку стоимости проекта по компонентам.
- Изготовление тестовой платы монтаж и пусконаладочные работы.



Тел: +7 (812) 336 43 04 (многоканальный)

Email: org@lifeelectronics.ru