

Insulated Gate Bipolar Transistor (Trench IGBT), 140 A



SOT-227

PRODUCT SUMMARY	
V_{CES}	600 V
I_C DC	140 A at 90 °C ⁽¹⁾
$V_{CE(on)}$ typical at 100 A, 25 °C	1.72 V
I_F DC	71 A at 90 °C
Speed	8 kHz to 30 kHz
Package	SOT-227
Circuit	Single switch diode

Note

⁽¹⁾ Maximum collector current admitted is 100 A, to do not exceed the maximum temperature of terminals

FEATURES

- Trench IGBT technology with positive temperature coefficient
- Square RBSOA
- 3 μ s short circuit capability
- FRED Pt[®] antiparallel diodes with ultrasoft reverse recovery
- T_J maximum = 175 °C
- Fully isolated package
- Very low internal inductance (≤ 5 nH typical)
- Industry standard outline
- UL approved file E78996 
- Material categorization: for definitions of compliance please see www.vishay.com/doc?99912

**RoHS
COMPLIANT**
BENEFITS

- Designed for increased operating efficiency in power conversion: UPS, SMPS, welding, induction heating
- Easy to assemble and parallel
- Direct mounting to heatsink
- Plug-in compatible with other SOT-227 packages
- Lower conduction losses and switching losses
- Low EMI, requires less snubbing

ABSOLUTE MAXIMUM RATINGS				
PARAMETER	SYMBOL	TEST CONDITIONS	MAX.	UNITS
Collector to emitter voltage	V_{CES}		600	V
Continuous collector current	I_C ⁽¹⁾	$T_C = 25$ °C	200	A
		$T_C = 90$ °C	140	
Pulsed collector current	I_{CM}		350	
Clamped inductive load current	I_{LM}		350	
Diode continuous forward current	I_F	$T_C = 25$ °C	104	
		$T_C = 90$ °C	71	
Gate-to-emitter voltage	V_{GE}		± 20	V
Power dissipation, IGBT	P_D	$T_C = 25$ °C	652	W
		$T_C = 90$ °C	370	
Power dissipation, diode	P_D	$T_C = 25$ °C	238	
		$T_C = 90$ °C	135	
Isolation voltage	V_{ISOL}	Any terminal to case, $t = 1$ min	2500	V

Note

⁽¹⁾ Maximum collector current admitted is 100 A, to do not exceed the maximum temperature of terminals



ELECTRICAL SPECIFICATIONS ($T_J = 25\text{ }^\circ\text{C}$ unless otherwise specified)						
PARAMETER	SYMBOL	TEST CONDITIONS	MIN.	TYP.	MAX.	UNITS
Collector to emitter breakdown voltage	$V_{BR(CES)}$	$V_{GE} = 0\text{ V}, I_C = 250\text{ }\mu\text{A}$	600	-	-	V
Collector to emitter voltage	$V_{CE(on)}$	$V_{GE} = 15\text{ V}, I_C = 100\text{ A}$	-	1.7	2.0	
		$V_{GE} = 15\text{ V}, I_C = 100\text{ A}, T_J = 125\text{ }^\circ\text{C}$	-	2.0	2.2	
		$V_{GE} = 15\text{ V}, I_C = 100\text{ A}, T_J = 175\text{ }^\circ\text{C}$	-	2.15	-	
Gate threshold voltage	$V_{GE(th)}$	$V_{CE} = V_{GE}, I_C = 250\text{ }\mu\text{A}$	3.5	4.6	6.5	
		$V_{CE} = V_{GE}, I_C = 250\text{ }\mu\text{A}, T_J = 125\text{ }^\circ\text{C}$	-	2.65	-	
Temperature coefficient of threshold voltage	$\Delta V_{GE(th)}/\Delta T_J$	$V_{CE} = V_{GE}, I_C = 1\text{ mA}$ (25 °C to 125 °C)	-	-16.8	-	mV/°C
Collector to emitter leakage current	I_{CES}	$V_{GE} = 0\text{ V}, V_{CE} = 600\text{ V}$	-	0.6	100	μA
		$V_{GE} = 0\text{ V}, V_{CE} = 600\text{ V}, T_J = 125\text{ }^\circ\text{C}$	-	0.15	3	mA
		$V_{GE} = 0\text{ V}, V_{CE} = 600\text{ V}, T_J = 175\text{ }^\circ\text{C}$	-	8	-	
Forward voltage drop, diode	V_{FM}	$I_F = 40\text{ A}, V_{GE} = 0\text{ V}$	-	1.74	2.2	V
		$I_F = 40\text{ A}, V_{GE} = 0\text{ V}, T_J = 125\text{ }^\circ\text{C}$	-	1.35	1.74	
		$I_F = 40\text{ A}, V_{GE} = 0\text{ V}, T_J = 150\text{ }^\circ\text{C}$	-	1.2	-	
Gate to emitter leakage current	I_{GES}	$V_{GE} = \pm 20\text{ V}$	-	-	± 200	nA

SWITCHING CHARACTERISTICS ($T_J = 25\text{ }^\circ\text{C}$ unless otherwise specified)								
PARAMETER	SYMBOL	TEST CONDITIONS	MIN.	TYP.	MAX.	UNITS		
Turn-on switching loss	E_{on}	$I_C = 100\text{ A}, V_{CC} = 360\text{ V}, V_{GE} = 15\text{ V}, R_g = 5\text{ }\Omega, L = 500\text{ }\mu\text{H}, T_J = 25\text{ }^\circ\text{C}$	-	0.43	-	mJ		
Turn-off switching loss	E_{off}		-	1.50	-			
Total switching loss	E_{tot}		-	1.93	-			
Turn-on delay time	$t_{d(on)}$		Energy losses include tail and diode recovery. Diode used 60APH06	-	130	-	ns	
Rise time	t_r			-	50	-		
Turn-off delay time	$t_{d(off)}$			-	127	-		
Fall time	t_f			-	82	-		
Turn-on switching loss	E_{on}			-	0.43	-		mJ
Turn-off switching loss	E_{off}			-	2.12	-		
Total switching loss	E_{tot}			-	2.55	-		
Turn-on delay time	$t_{d(on)}$	$I_C = 100\text{ A}, V_{CC} = 360\text{ V}, V_{GE} = 15\text{ V}, R_g = 5\text{ }\Omega, L = 500\text{ }\mu\text{H}, T_J = 125\text{ }^\circ\text{C}$		-	130	-	ns	
Rise time	t_r			-	52	-		
Turn-off delay time	$t_{d(off)}$			-	130	-		
Fall time	t_f		-	100	-			
Reverse bias safe operating area	RBSOA	$T_J = 175\text{ }^\circ\text{C}, I_C = 350\text{ A}, R_g = 22\text{ }\Omega, V_{GE} = 15\text{ V to } 0\text{ V}, V_{CC} = 400\text{ V}, V_P = 600\text{ V}, L = 500\text{ }\mu\text{H}$	Fullsquare					
Diode reverse recovery time	t_{rr}	$I_F = 50\text{ A}, di_F/dt = 200\text{ A}/\mu\text{s}, V_R = 200\text{ V}$	-	72	-	ns		
Diode reverse recovery current	I_{rr}		-	5.5	-	A		
Diode recovery charge	Q_{rr}		-	200	-	nC		
Diode reverse recovery time	t_{rr}	$I_F = 50\text{ A}, di_F/dt = 200\text{ A}/\mu\text{s}, V_R = 200\text{ V}, T_J = 125\text{ }^\circ\text{C}$	-	144	-	ns		
Diode peak reverse current	I_{rr}		-	13	-	A		
Diode recovery charge	Q_{rr}		-	930	-	nC		
Short circuit safe operating area	SCSOA	$T_J = 175\text{ }^\circ\text{C}, R_g = 22\text{ }\Omega, V_{GE} = 15\text{ V to } 0\text{ V}, V_{CC} = 400\text{ V}, V_P = 600\text{ V}$	3			μs		



THERMAL AND MECHANICAL SPECIFICATIONS						
PARAMETER	SYMBOL		MIN.	TYP.	MAX.	UNITS
Junction and storage temperature range	T_J, T_{Stg}		-40	-	175	°C
Junction to case	IGBT	R_{thJC}	-	-	0.23	°C/W
	Diode		-	-	0.63	
Case to heatsink	R_{thCS}	Flat, greased surface	-	0.1	-	
Weight			-	30	-	g
Mounting torque			-	-	1.3	Nm
Case style	SOT-227					

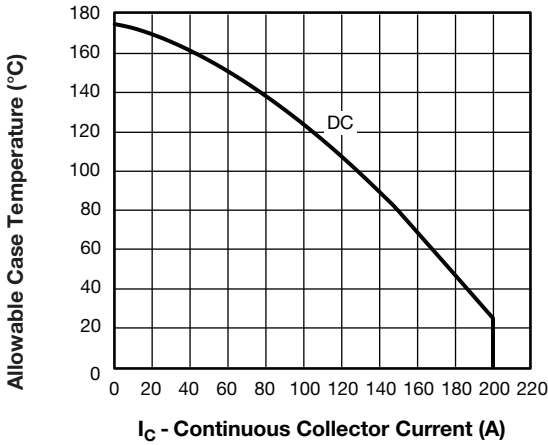

Fig. 1 - Maximum DC IGBT Collector Current vs. Case Temperature

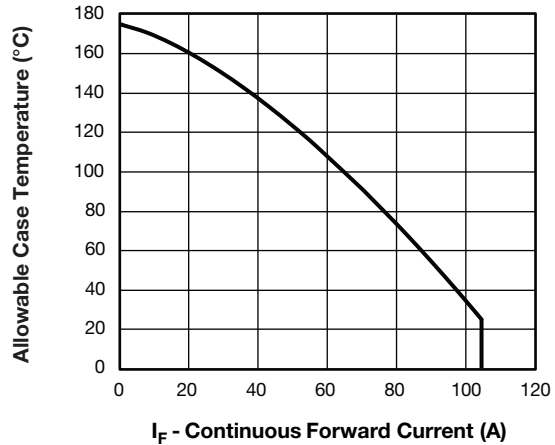

Fig. 3 - Maximum Allowable Forward Current vs. Case Temperature, Diode Leg

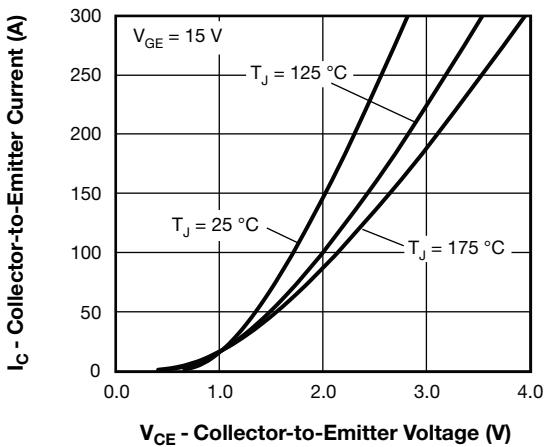

Fig. 2 - Typical Collector to Emitter Current Output Characteristics of IGBT

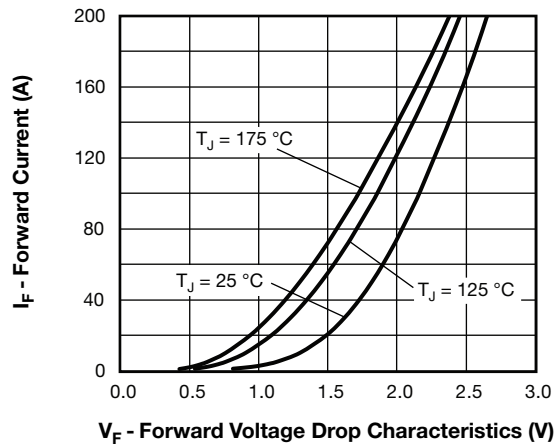

Fig. 4 - Typical Diode Forward Voltage Drop Characteristics

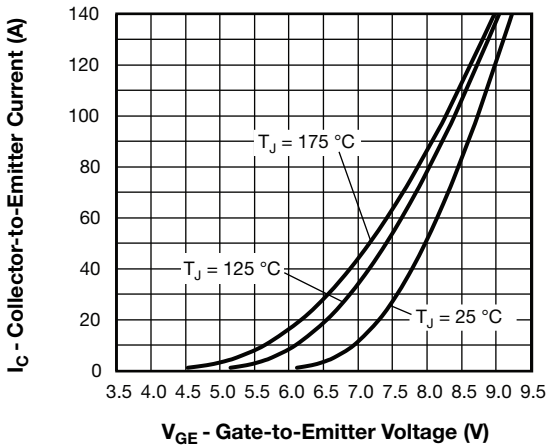

Fig. 5 - Typical IGBT Transfer Characteristics

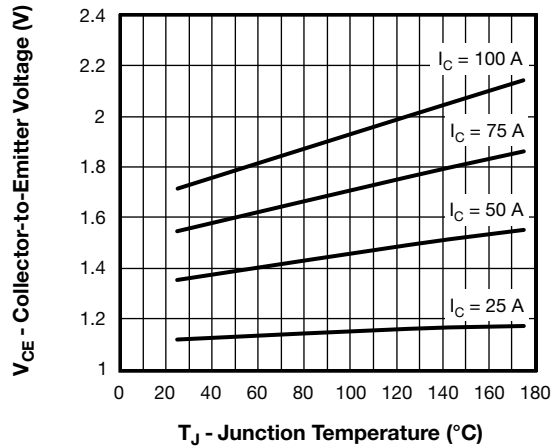

Fig. 8 - Typical IGBT Collector to Emitter Voltage vs. Junction Temperature, $V_{GE} = 15\text{ V}$

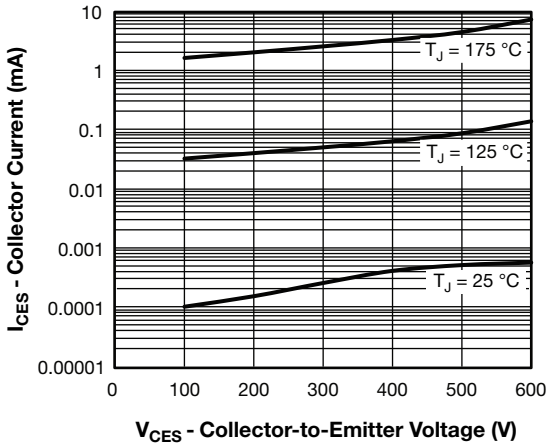

Fig. 6 - Typical IGBT Zero Gate Voltage Collector Current

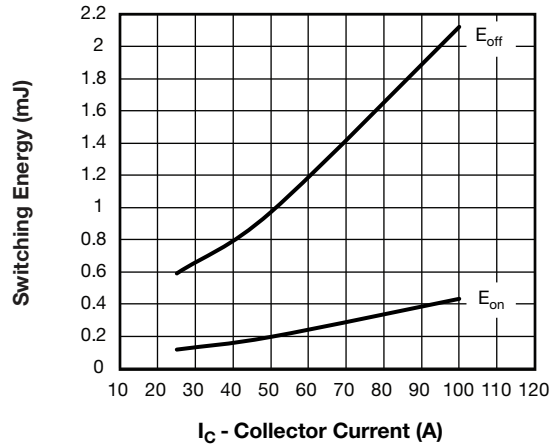

Fig. 9 - Typical IGBT Energy Losses vs. I_C
 $T_J = 125\text{ }^\circ\text{C}$, $L = 500\text{ }\mu\text{H}$, $V_{CC} = 360\text{ V}$,
 $R_g = 5\text{ }\Omega$, $V_{GE} = 15\text{ V}$, Diode used: 60APH06

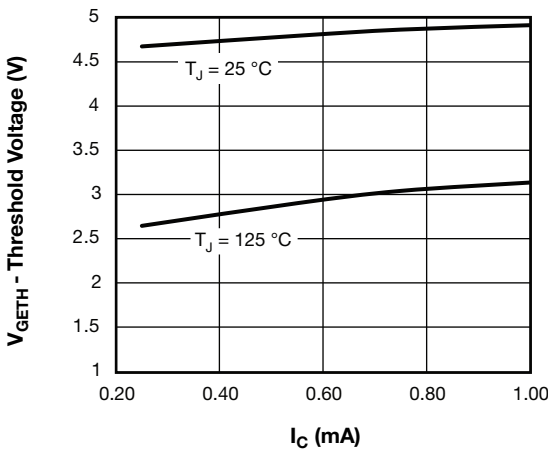

Fig. 7 - Typical IGBT Threshold Voltage

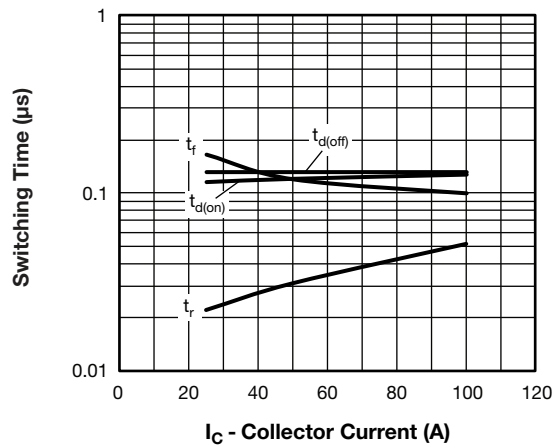

Fig. 10 - Typical IGBT Switching Time vs. I_C
 $T_J = 125\text{ }^\circ\text{C}$, $L = 500\text{ }\mu\text{H}$, $V_{CC} = 360\text{ V}$,
 $R_g = 5\text{ }\Omega$, $V_{GE} = 15\text{ V}$, Diode used: 60APH06

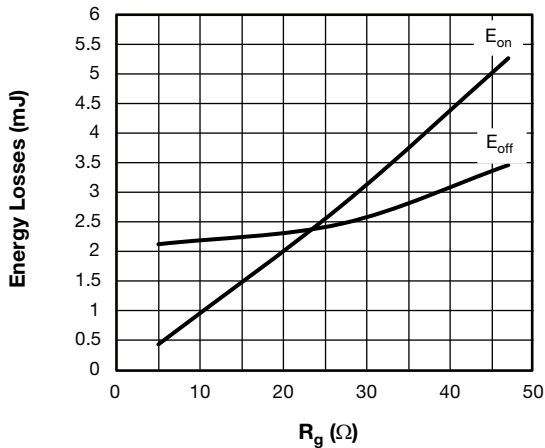

Fig. 11 - Typical IGBT Energy Loss vs. R_g
 $T_J = 125\text{ }^\circ\text{C}$, $I_C = 100\text{ A}$, $L = 500\text{ }\mu\text{H}$,
 $V_{CC} = 360\text{ V}$, $V_{GE} = 15\text{ V}$, Diode used: 60APH06

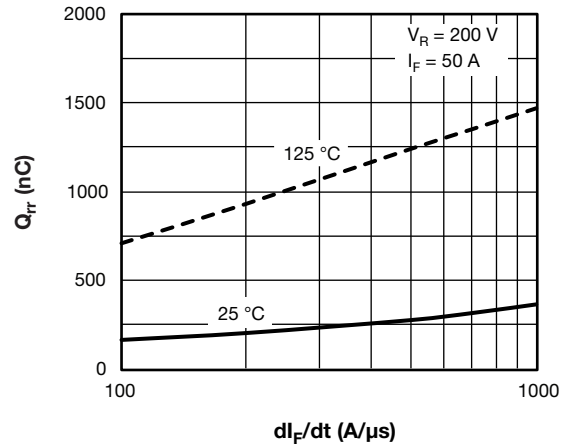

Fig. 14 - Typical Stored Charge vs. dI_F/dt of Diode

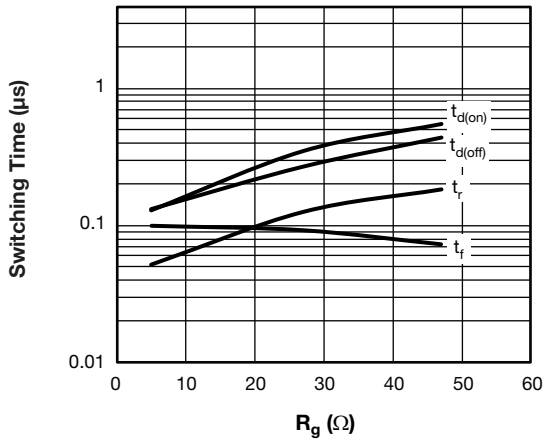

Fig. 12 - Typical IGBT Switching Time vs. R_g
 $T_J = 125\text{ }^\circ\text{C}$, $L = 500\text{ }\mu\text{H}$, $V_{CC} = 360\text{ V}$,
 $I_C = 100\text{ A}$, $V_{GE} = 15\text{ V}$, Diode used: 60APH06

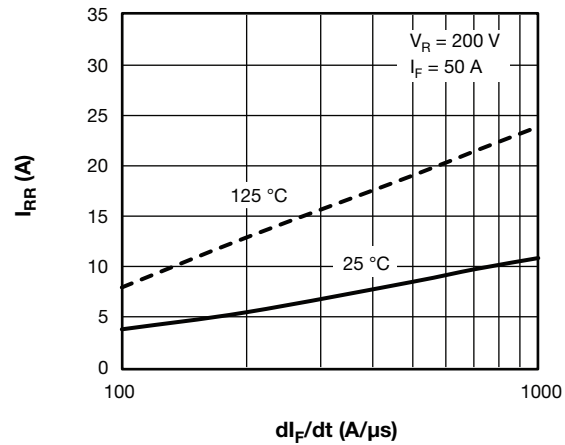

Fig. 15 - Typical Reverse Recovery Current vs. dI_F/dt of Diode

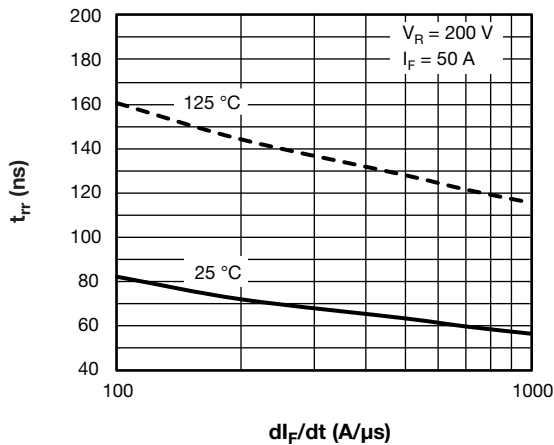

Fig. 13 - Typical Reverse Recovery Time vs. dI_F/dt of Diode

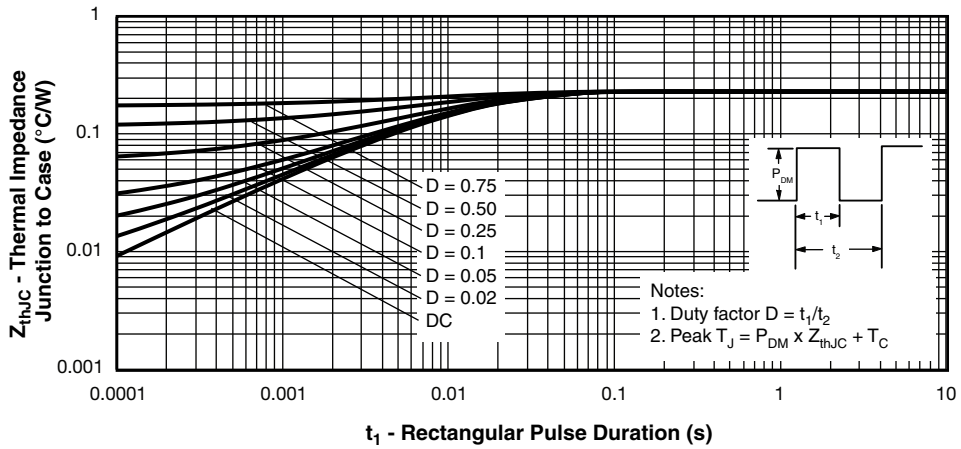

Fig. 16 - Maximum Thermal Impedance Z_{thJC} Characteristics, IGBT

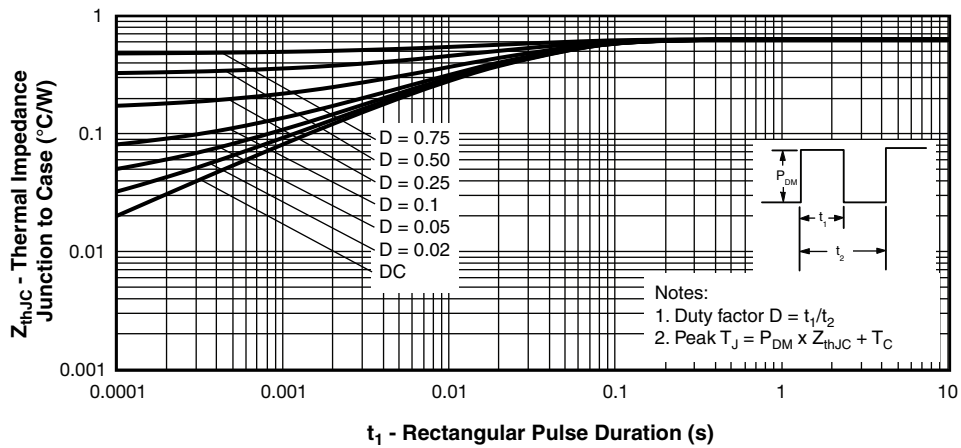

Fig. 17 - Maximum Thermal Impedance Z_{thJC} Characteristics, Diode

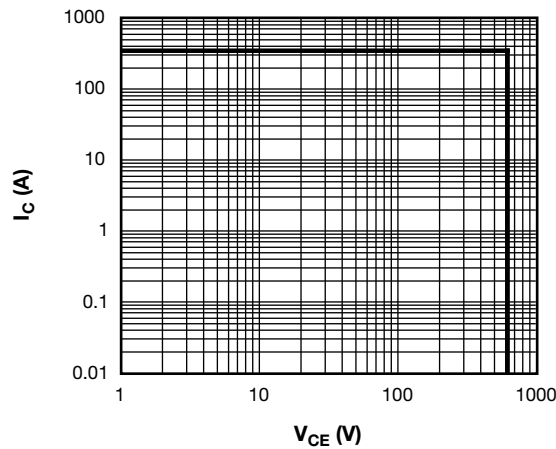
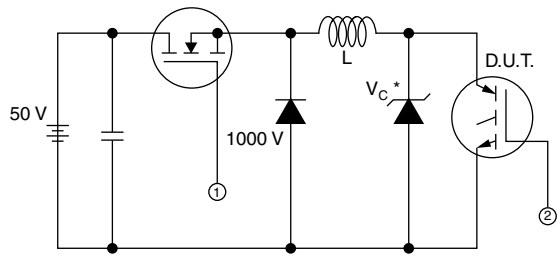
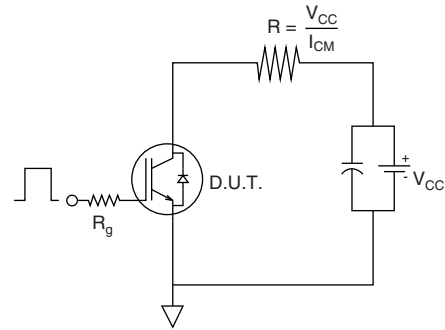

Fig. 18 - IGBT Reverse BIAS SOA, $T_J = 175\text{ }^\circ\text{C}$, $V_{GE} = 15\text{ V}$



* Driver same type as D.U.T.; $V_C = 80\%$ of $V_{ce(max)}$
 * Note: Due to the 50 V power supply, pulse width and inductor will increase to obtain I_d

19a - Clamped Inductive Load Test Circuit



19b - Pulsed Collector Current Test Circuit

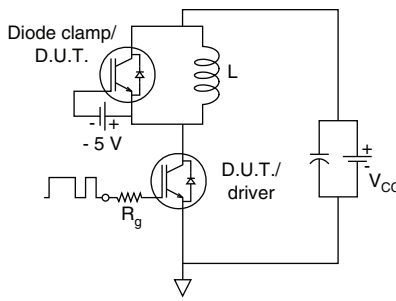

20a - Switching Loss Test Circuit

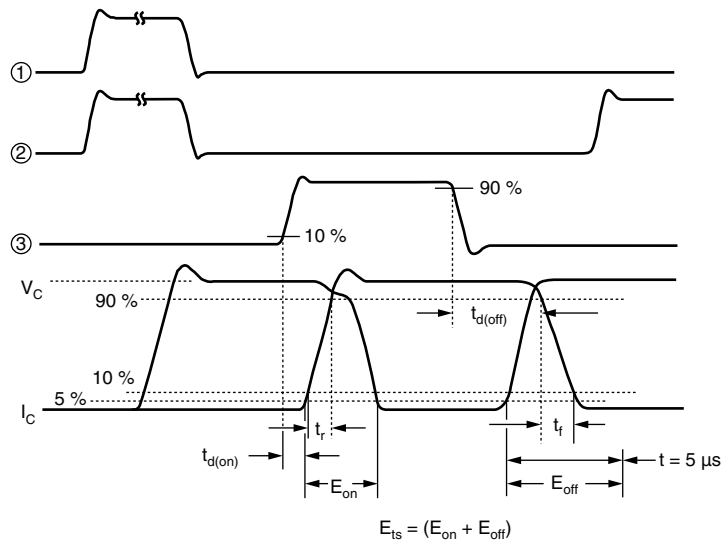

20b - Switching Loss Waveforms Test Circuit

ORDERING INFORMATION TABLE

Device code	VS-	G	T	140	D	A	60	U
	①	②	③	④	⑤	⑥	⑦	⑧

- 1** - Vishay Semiconductors product
- 2** - Insulated Gate Bipolar Transistor (IGBT)
- 3** - T = Trench IGBT Technology
- 4** - Current rating (140 = 140 A)
- 5** - Circuit configuration (D = Single switch with antiparallel diode)
- 6** - Package indicator (A = SOT-227)
- 7** - Voltage rating (60 = 600 V)
- 8** - Speed/type (U = Ultrafast IGBT)

CIRCUIT CONFIGURATION		
CIRCUIT	CIRCUIT CONFIGURATION CODE	CIRCUIT DRAWING
Single switch diode	D	

LINKS TO RELATED DOCUMENTS	
Dimensions	www.vishay.com/doc?95423
Packaging information	www.vishay.com/doc?95425



SOT-227 Generation II

DIMENSIONS in millimeters (inches)



Note

- Controlling dimension: millimeter



Disclaimer

ALL PRODUCT, PRODUCT SPECIFICATIONS AND DATA ARE SUBJECT TO CHANGE WITHOUT NOTICE TO IMPROVE RELIABILITY, FUNCTION OR DESIGN OR OTHERWISE.

Vishay Intertechnology, Inc., its affiliates, agents, and employees, and all persons acting on its or their behalf (collectively, "Vishay"), disclaim any and all liability for any errors, inaccuracies or incompleteness contained in any datasheet or in any other disclosure relating to any product.

Vishay makes no warranty, representation or guarantee regarding the suitability of the products for any particular purpose or the continuing production of any product. To the maximum extent permitted by applicable law, Vishay disclaims (i) any and all liability arising out of the application or use of any product, (ii) any and all liability, including without limitation special, consequential or incidental damages, and (iii) any and all implied warranties, including warranties of fitness for particular purpose, non-infringement and merchantability.

Statements regarding the suitability of products for certain types of applications are based on Vishay's knowledge of typical requirements that are often placed on Vishay products in generic applications. Such statements are not binding statements about the suitability of products for a particular application. It is the customer's responsibility to validate that a particular product with the properties described in the product specification is suitable for use in a particular application. Parameters provided in datasheets and/or specifications may vary in different applications and performance may vary over time. All operating parameters, including typical parameters, must be validated for each customer application by the customer's technical experts. Product specifications do not expand or otherwise modify Vishay's terms and conditions of purchase, including but not limited to the warranty expressed therein.

Except as expressly indicated in writing, Vishay products are not designed for use in medical, life-saving, or life-sustaining applications or for any other application in which the failure of the Vishay product could result in personal injury or death. Customers using or selling Vishay products not expressly indicated for use in such applications do so at their own risk. Please contact authorized Vishay personnel to obtain written terms and conditions regarding products designed for such applications.

No license, express or implied, by estoppel or otherwise, to any intellectual property rights is granted by this document or by any conduct of Vishay. Product names and markings noted herein may be trademarks of their respective owners.

Material Category Policy

Vishay Intertechnology, Inc. hereby certifies that all its products that are identified as RoHS-Compliant fulfill the definitions and restrictions defined under Directive 2011/65/EU of The European Parliament and of the Council of June 8, 2011 on the restriction of the use of certain hazardous substances in electrical and electronic equipment (EEE) - recast, unless otherwise specified as non-compliant.

Please note that some Vishay documentation may still make reference to RoHS Directive 2002/95/EC. We confirm that all the products identified as being compliant to Directive 2002/95/EC conform to Directive 2011/65/EU.

Vishay Intertechnology, Inc. hereby certifies that all its products that are identified as Halogen-Free follow Halogen-Free requirements as per JEDEC JS709A standards. Please note that some Vishay documentation may still make reference to the IEC 61249-2-21 definition. We confirm that all the products identified as being compliant to IEC 61249-2-21 conform to JEDEC JS709A standards.

Компания «Life Electronics» занимается поставками электронных компонентов импортного и отечественного производства от производителей и со складов крупных дистрибьюторов Европы, Америки и Азии.

С конца 2013 года компания активно расширяет линейку поставок компонентов по направлению коаксиальный кабель, кварцевые генераторы и конденсаторы (керамические, пленочные, электролитические), за счёт заключения дистрибьюторских договоров

Мы предлагаем:

- Конкурентоспособные цены и скидки постоянным клиентам.
- Специальные условия для постоянных клиентов.
- Подбор аналогов.
- Поставку компонентов в любых объемах, удовлетворяющих вашим потребностям.
- Приемлемые сроки поставки, возможна ускоренная поставка.
- Доставку товара в любую точку России и стран СНГ.
- Комплексную поставку.
- Работу по проектам и поставку образцов.
- Формирование склада под заказчика.
- Сертификаты соответствия на поставляемую продукцию (по желанию клиента).
- Тестирование поставляемой продукции.
- Поставку компонентов, требующих военную и космическую приемку.
- Входной контроль качества.
- Наличие сертификата ISO.

В составе нашей компании организован Конструкторский отдел, призванный помогать разработчикам, и инженерам.

Конструкторский отдел помогает осуществить:

- Регистрацию проекта у производителя компонентов.
- Техническую поддержку проекта.
- Защиту от снятия компонента с производства.
- Оценку стоимости проекта по компонентам.
- Изготовление тестовой платы монтаж и пусконаладочные работы.



Тел: +7 (812) 336 43 04 (многоканальный)

Email: org@lifeelectronics.ru