

EAO – Your Expert Partner for
Human Machine Interfaces



EAO Product Information

Series 31



| | |
|-------------------------------|----|
| Description | 3 |
| Product Assembly | 4 |
| Devices raised mounting | 5 |
| Accessories..... | 7 |
| Technical Data..... | 12 |
| Typical Applications | 15 |
| Application guidelines..... | 17 |
| Marking | 18 |
| Drawings..... | 19 |
| Index..... | 27 |

Indicator round, raised mounting



- 1 Lens
- 2 LED
- 3 Switch housing
- 4 Front plate
- 5 Fixing nut

Illuminated pushbutton rectangular, raised mounting



- 1 Lens
- 2 LED
- 3 Switch housing
- 4 Front plate
- 5 Fixing nut

Product Information

General notes

The series 31 illuminated pushbuttons are equipped with snap-action or low-level switching elements.

Besides the standard contacts (gold-plated silver) silver contacts for switching elements 2.8 mm plug-in terminals can be supplied on request.

The front dimensions of these units are 18 x 24 mm, 18 x 18 mm or 18 mm dia.

In addition to a number of illuminated pushbuttons, the customer can choose from a range of other units and accessories having the same front and mounting dimensions: Indicators, Flashers, Buzzers, etc. (For keylock switches see series 51 or 61.)

Mounting

All switch actuators are mounted from the front by pushing them through the mounting hole in the front panel. They are then fixed from the back with a fixing nut and the mounting tool Typ-Nr. 01-907. Max. tightening torque 50 Ncm.

For switching elements with 2.8 mm plug-in terminals, we offer plug-in bases, which when soldered to a PCB enable a plug-in connection to the button. The rectangular actuators are provided with an anti-twisting device.

Lenses

The flat or concave lenses, made of Polymethyl Methacrylate, are available in various colours, as well as translucent or transparent.

Marking

For further information about engraving, hot stamping and film inserts see part Marking.

Illumination

The T1 $\frac{3}{4}$ Midget Groove incandescent (filament) lamp (6 ... 48 V) ensures perfect illumination of the lenses, which are supplied in various colours.

T1 $\frac{3}{4}$ Midget Groove Single-LED (6, 12, 24, 28, 48 V) are also available in blue, green, red, white or yellow.

Luminosity and wave length scattering caused by the technology used in the LED manufacturing processes may lead to visual differences in our products.

For supply voltages above 48 V, it is necessary to use a voltage reduction element (external series resistor or transformer).

Position indication

The status of a maintained action switch can be determined by the position of the lens.

Specimen order

Indicator :

- | | |
|--|------------|
| - Indicator actuator, 18 x 24 mm, soldering terminal | 31-040.005 |
|--|------------|

Essential accessories :

- | | |
|---|--------------|
| - Lens plastic blue, transparent, flush, 18 x 24 mm | 31-903.6 |
| - Single-LED, T1 $\frac{3}{4}$ MG, 24 VAC/DC, blau | 10-2J12.1066 |

*We reserve the right to modify technical data
All dimensions in mm*

Indicator actuator



Essential Accessories:

-  Lens plastic page 7
-  Single-LED page 10

| | Front protection | Diode (1N 4007) | Terminals | \varnothing 18 x 18 mm Typ-Nr. | \varnothing 18 x 24 mm Typ-Nr. | \varnothing 18 mm Typ-Nr. | Component layout | Mounting dimensions | Technical drawing | Circuit drawing |  |
|---------------------------|------------------|-----------------|-----------|-------------------------------------|-------------------------------------|--------------------------------|------------------|---------------------|-------------------|-----------------|---|
| Indicator actuator | IP 40 | 1 D | UT | 31-703.006 | 31-701.006 | | 4 | 1 | 7 | 33 | 0.006 |
| | | 2 D | UT | 31-704.006 | 31-702.006 | | 4 | 1 | 7 | 34 | 0.006 |
| | - | S | | 31-050.005 | 31-040.005 | 31-030.005 | | 1 | 7 | 4 | 0.004 |
| | | S1 | | 31-050.002 | 31-040.002 | 31-030.002 | | 1 | 7 | 3 | 0.004 |
| | | UT | | 31-051.006 | 31-041.006 | 31-031.006 | | 4 | 1 | 7 | 3 |

Diode (1N 4007): D = Diode, - = without

Terminals: UT = Universal terminal, S = Soldering terminal, S1 = Soldering terminal (also pluggable 2.8 x 0.5 mm)

Component layout from page 19, Mounting dimensions from page 20, Technical drawing from page 20, Circuit drawing from page 22

Buzzer



| | Front protection | Front cap | Terminals | \varnothing 18 x 24 mm Typ-Nr. | Mounting dimensions | Technical drawing | Circuit drawing |  |
|--|------------------|---------------|-----------|-------------------------------------|---------------------|-------------------|-----------------|---|
| Buzzer Operation voltage : 10 ... 26 VDC | IP 40 | Plastic black | S1 | 31-801.002 | 1 | 3 | 1 | 0.015 |
| Operation voltage : 10 ... 55 VAC, 10 ... 75 VDC | IP 40 | Plastic black | S | 31-810.005 | 1 | 3 | 2 | 0.015 |

Further information in the Technical Data and Typical Applications



Terminals: S1 = Soldering terminal (also pluggable 2.8 x 0.5 mm), S = Soldering terminal

Mounting dimensions from page 20, Technical drawing from page 20, Circuit drawing from page 22

Illuminated pushbutton actuator



Essential Accessories:

-  Lens plastic page 7
-  Single-LED page 10

| | Front protection | Switching system | Contacts | Diode (1N 4007) | Switching action | Terminals | | | | Component layout | Mounting dimensions | Technical drawing | Circuit drawing |  | | |
|--|------------------|------------------|-------------|-----------------|------------------|-----------|-------------------------|-------------------------|--------------------|------------------|---------------------|-------------------|-----------------|---|-------|-------|
| | | | | | | | ∅ 18 x 18 mm Typ-Nr. | ∅ 18 x 24 mm Typ-Nr. | ∅ 18 mm Typ-Nr. | | | | | | | |
| Illuminated pushbutton actuator | IP 40 | LL | 1 NC | - | MA | UT | 31-486.036 | 31-466.036 | 31-476.036 | 4 | 1 | 8 | 14 | 0.007 | | |
| | | | | | M | UT | 31-456.036 | 31-426.036 | 31-436.036 | 4 | 1 | 8 | 28 | 0.007 | | |
| | | | 1 NC + 1 NO | - | MA | UT | 31-483.036 | 31-463.036 | 31-473.036 | 4 | 1 | 8 | 17 | 0.007 | | |
| | | | | | M | UT | 31-453.036 | 31-423.036 | 31-433.036 | 4 | 1 | 8 | 31 | 0.007 | | |
| | | | 1 NO | - | MA | UT | 31-485.036 | 31-465.036 | 31-475.036 | 4 | 1 | 8 | 16 | 0.007 | | |
| | | | | | M | UT | 31-455.036 | 31-425.036 | 31-435.036 | 4 | 1 | 8 | 30 | 0.007 | | |
| | | | 2 NC | - | MA | UT | 31-482.036 | 31-462.036 | 31-472.036 | 4 | 1 | 8 | 15 | 0.007 | | |
| | | | | | M | UT | 31-452.036 | 31-422.036 | 31-432.036 | 4 | 1 | 8 | 29 | 0.007 | | |
| | | | 2 NO | - | MA | UT | 31-481.036 | 31-461.036 | 31-471.036 | 4 | 1 | 8 | 18 | 0.007 | | |
| | | | | | M | UT | 31-451.036 | 31-421.036 | 31-431.036 | 4 | 1 | 8 | 32 | 0.007 | | |
| | | | SA | 1 NC + 1 NO | 1 D | | MA | UT | 31-717.0292 | 31-713.0292 | 31-747.0292 | 4 | 1 | 8 | 11 | 0.008 |
| | | | | | | | M | UT | 31-709.0292 | 31-705.0292 | 31-743.0292 | 4 | 1 | 8 | 25 | 0.008 |
| | | | | | 2 D | | MA | UT | 31-718.0292 | 31-714.0292 | 31-748.0292 | 4 | 1 | 8 | 12 | 0.008 |
| | | | | | | | M | UT | 31-710.0292 | 31-706.0292 | 31-744.0292 | 4 | 1 | 8 | 26 | 0.008 |
| | | - | | | | MA | S | 31-281.0252 | 31-261.0252 | 31-271.0252 | | 1 | 8 | 13 | 0.006 | |
| | | | | | | | | S1 | 31-281.022 | 31-261.022 | 31-271.022 | | 1 | 8 | 10 | 0.006 |
| | | | | | | M | S | 31-151.0252 | 31-121.0252 | 31-131.0252 | | 1 | 8 | 27 | 0.006 | |
| | | | | | | | | S1 | 31-151.022 | 31-121.022 | 31-131.022 | | 1 | 8 | 24 | 0.006 |
| | | 2 NC + 2 NO | | | 1 D | | MA | UT | 31-719.0292 | 31-715.0292 | 31-749.0292 | 4 | 1 | 8 | 7 | 0.010 |
| | | | | | | | M | UT | 31-711.0292 | 31-707.0292 | 31-745.0292 | 4 | 1 | 8 | 21 | 0.010 |
| | | | | | 2 D | | MA | UT | 31-720.0292 | 31-716.0292 | 31-750.0292 | 4 | 1 | 8 | 8 | 0.010 |
| | | | | | | | M | UT | 31-712.0292 | 31-708.0292 | 31-746.0292 | 4 | 1 | 8 | 22 | 0.010 |
| | | | | | - | | MA | S | 31-282.0252 | 31-262.0252 | 31-272.0252 | | 1 | 8 | 9 | 0.008 |
| | | | | | | | | | S | 31-152.0252 | 31-122.0252 | 31-132.0252 | | 1 | 8 | 23 |
| | | 3 NC + 3 NO | | | - | | MA | S | 31-283.0252 | 31-263.0252 | 31-273.0252 | | 1 | 8 | 6 | 0.010 |
| | | | | | | | M | S | 31-153.0252 | 31-123.0252 | 31-133.0252 | | 1 | 8 | 20 | 0.010 |
| | | 4 NC + 4 NO | | | - | | MA | S | 31-284.0252 | 31-264.0252 | 31-274.0252 | | 1 | 8 | 5 | 0.012 |
| | | | | | | | M | S | 31-154.0252 | 31-124.0252 | 31-134.0252 | | 1 | 8 | 19 | 0.012 |

Power rating: Low level switching element 42 V, 100 mA; Snap action switching element 250 V, 5 A

Switching system: LL = Low level switching element, SA = Snap-action switching element

Contacts: NC = Normally closed, NO = Normally open

Diode (1N 4007): - = without, D = Diode

Switching action: MA = Maintained action, M = Momentary action

Terminals: UT = Universal terminal, S = Soldering terminal, S1 = Soldering terminal (also pluggable 2.8 x 0.5 mm)

Component layout from page 19, Mounting dimensions from page 20, Technical drawing from page 20, Circuit drawing from page 22

Front

Lens plastic

| | Lens | ∅ 18 x 18 mm Typ-Nr. | ∅ 18 x 24 mm Typ-Nr. | ∅ 18 mm Typ-Nr. |  |
|--|--|-------------------------|-------------------------|--------------------|---|
| Lens plastic concave, illuminative | blue transparent | 31-954.6 | 31-904.6 | | 0.001 |
| | colourless transparent | 31-954.7 | 31-904.7 | | 0.001 |
| | green transparent | 31-954.5 | 31-904.5 | | 0.001 |
| | orange transparent | 31-954.3 | 31-904.3 | | 0.001 |
| | red transparent | 31-954.2 | 31-904.2 | | 0.001 |
| | yellow transparent | 31-954.4 | 31-904.4 | | 0.001 |
| concave, non-illuminative | black opaque | 31-952.0 | 31-902.0 | | 0.001 |
| | grey opaque | | 31-902.8 | | 0.001 |
| flush, illuminative | blue transparent | 31-953.6 | 31-903.6 | 31-933.6 | 0.001 |
| | colourless transparent | 31-953.7 | 31-903.7 | 31-933.7 | 0.001 |
| | green transparent | 31-953.5 | 31-903.5 | 31-933.5 | 0.001 |
| | orange transparent | 31-953.3 | 31-903.3 | 31-933.3 | 0.001 |
| | red transparent | 31-953.2 | 31-903.2 | 31-933.2 | 0.001 |
| | smoked transparent | 31-953.1 | 31-903.1 | 31-933.1 | 0.001 |
| | yellow transparent | 31-953.4 | 31-903.4 | 31-933.4 | 0.001 |
| | flush, illuminative (not recommended for film insert) | blue translucent | 31-951.6 | 31-901.6 | 31-931.6 |
| colourless transparent | | 31-955.7 | 31-905.7 | 31-935.7 | 0.001 |
| green translucent | | 31-951.5 | 31-901.5 | 31-931.5 | 0.001 |
| green transparent | | 31-955.5 | 31-905.5 | 31-935.5 | 0.001 |
| orange translucent | | 31-951.3 | 31-901.3 | 31-931.3 | 0.001 |
| red translucent | | 31-951.2 | 31-901.2 | 31-931.2 | 0.001 |
| red transparent | | 31-955.2 | 31-905.2 | 31-935.2 | 0.001 |
| white translucent | | 31-951.9 | 31-901.9 | 31-931.9 | 0.001 |
| yellow translucent | | 31-951.4 | 31-901.4 | 31-931.4 | 0.001 |
| yellow transparent | | 31-955.4 | 31-905.4 | 31-935.4 | 0.001 |
| flush, non-illuminative | | black opaque | 31-951.0 | 31-901.0 | 31-931.0 |
| | grey opaque | 31-951.8 | 31-901.8 | 31-931.8 | 0.001 |



Protective cover

| | ∅ 18 x 18 mm Typ-Nr. | ∅ 18 x 24 mm Typ-Nr. | Technical drawing |  |
|--|-------------------------|-------------------------|-------------------|---|
| Protective cover hinged, transparent, with means for sealing | 31-920 | | 5 | 0.002 |
| | | 31-925 | 6 | 0.002 |



Technical drawing from page 20

Front protective cap

front protection IP 67

| | | Ø 18 x 18 mm Typ-Nr. | Ø 18 x 24 mm Typ-Nr. | Mounting dimensions | Technical drawing | kg |
|---|---------|-------------------------|-------------------------|---------------------|-------------------|-------|
| Front protective cap | | | | | | |
| Front protective cap two-part | PVC | 31-923 | | 2 | 4 | 0.003 |
| | Silikon | | 31-924.2 | 2 | 4 | 0.003 |



Mounting dimensions from page 20, Technical drawing from page 20

Protective guard

matt chromium-plated

| | | Typ-Nr. | Technical drawing | kg |
|---|--|---------------|-------------------|-------|
| Protective guard broad sides bent upwards | | 01-927 | 2 | 0.011 |
| narrow ends bent upwards | | 01-926 | 1 | 0.011 |



Technical drawing from page 20

Blind plug

| | | Ø 18 x 18 mm Typ-Nr. | Ø 18 x 24 mm Typ-Nr. | Ø 18 mm Typ-Nr. | Mounting dimensions | kg |
|-------------------|---------------|-------------------------|-------------------------|--------------------|---------------------|-------|
| Blind plug | | | | | | |
| Blind plug | Plastic black | 01-948.0 | 01-947.0 | 01-949.0 | 1 | 0.001 |



Mounting dimensions from page 20

Backside

PCB plug-in base

| | Terminals | Typ-Nr. | Component layout |  |
|--|-----------|---------------|------------------|---|
| PCB plug-in base 16.4 mm dia. x 9.8 mm for Low level switching element, Pins axial | P | 31-940 | 2 | 0.002 |
| 17.8 x 12.9 mm x 9.8 mm for Snap-action switching element 2.8 mm, Pins axial | P | 31-942 | 3 | 0.002 |
| 17.9 x 17.9 x 8.4 mm for Low level switching element, Pins bent at right-angle | P | 31-941 | 1 | 0.004 |



PCB plug-in base Pins right-angle : With the extendable mounting the distance between plug-in base and PCB can be varied up to 3 mm.

Terminals: P = PCB terminal

Component layout from page 19

Flat receptacle

| | Typ-Nr. |  |
|---|---------------|---|
| Flat receptacle 2.0 x 0.5 mm for Universal terminal | 31-945 | 0.001 |
| 2.8 x 0.5 mm for Plug-in terminal | 31-946 | 0.001 |



Insulation sleeve

| | Typ-Nr. |  |
|--|---------------|---|
| Insulation sleeve Cover Plug-in terminals for snap-action switching element 2.8 mm | 01-928 | 0.001 |
| for Flat receptacle 31-945 | 31-928 | 0.001 |
| for Flat receptacle 31-946 | 31-929 | 0.001 |



Terminal cover

| | Typ-Nr. |  |
|-----------------------|---------------|---|
| Terminal cover | 01-929 | 0.010 |



Illumination

Filament lamp

| | Socket | Operating voltage/-current | Typ-Nr. |  |
|---------------|-----------|----------------------------|---------------------|---|
| Filament lamp | T1 3/4 MG | 12 VAC/DC, 75 mA | 10-1309.1309 | 0.001 |
| | | 14 VAC/DC, 80 mA | 10-1310.1319 | 0.001 |
| | | 18 VAC/DC, 40 mA | 10-1311.1249 | 0.001 |
| | | 24 VAC/DC, 35 mA | 10-1312.1229 | 0.001 |
| | | 28 VAC/DC, 30 mA | 10-1313.1209 | 0.001 |
| | | 28 VAC/DC, 40 mA | 10-1313.1249 | 0.001 |
| | | 36 VAC/DC, 20 mA | 10-1316.1179 | 0.001 |
| | | 36 VAC/DC, 30 mA | 10-1316.1209 | 0.001 |
| | | 48 VAC/DC, 20 mA | 10-1319.1179 | 0.001 |
| | | 48 VAC/DC, 25 mA | 10-1319.1199 | 0.001 |
| | | 6 VAC/DC, 120 mA | 10-1306.1349 | 0.001 |
| | | 6.3 VAC/DC, 200 mA | 10-1307.1369 | 0.001 |



Single-LED

| | Socket | Light colour | Operating voltage/-current | Typ-Nr. |  |
|------------|-----------|---------------|----------------------------|---------------------|---|
| Single-LED | T1 3/4 MG | blue | 12 VAC/DC, 7/14 mA | 10-2J09.1066 | 0.002 |
| | | | 24 VAC/DC, 7/14 mA | 10-2J12.1066 | 0.002 |
| | | | 28 VAC/DC, 7/14 mA | 10-2J13.1066 | 0.002 |
| | | | 48 VAC/DC, 4/8 mA | 10-2J19.1046 | 0.002 |
| | | | 6 VDC, 15 mA | 10-2J06.3146 | 0.002 |
| | | green | 12 VAC/DC, 4/7 mA | 10-2J09.1065 | 0.002 |
| | | | 24 VAC/DC, 4/7 mA | 10-2J12.1065 | 0.002 |
| | | | 28 VAC/DC, 4/7 mA | 10-2J13.1065 | 0.002 |
| | | | 48 VAC/DC, 2/4 mA | 10-2J19.1045 | 0.002 |
| | | | 6 VDC, 7 mA | 10-2J06.3145 | 0.002 |
| | | red | 12 VAC/DC, 7/14 mA | 10-2J09.1062 | 0.002 |
| | | | 24 VAC/DC, 7/14 mA | 10-2J12.1062 | 0.002 |
| | | | 28 VAC/DC, 7/14 mA | 10-2J13.1062 | 0.002 |
| | | | 48 VAC/DC, 4/8 mA | 10-2J19.1042 | 0.002 |
| | | | 6 VDC, 15 mA | 10-2J06.3142 | 0.002 |
| | | white diffuse | 12 VAC/DC, 7/14 mA | 10-2J09.1069 | 0.002 |
| | | | 24 VAC/DC, 7/14 mA | 10-2J12.1069 | 0.002 |
| | | | 28 VAC/DC, 7/14 mA | 10-2J13.1069 | 0.002 |
| | | | 48 VAC/DC, 4/8 mA | 10-2J19.1049 | 0.002 |
| | | | 6 VDC, 15 mA | 10-2J06.3149 | 0.002 |
| | | yellow | 12 VAC/DC, 7/14 mA | 10-2J09.1064 | 0.002 |
| | | | 24 VAC/DC, 7/14 mA | 10-2J12.1064 | 0.002 |
| | | | 28 VAC/DC, 7/14 mA | 10-2J13.1064 | 0.002 |
| | | | 48 VAC/DC, 4/8 mA | 10-2J19.1044 | 0.002 |
| | | | 6 VDC, 15 mA | 10-2J06.3144 | 0.002 |



Note:
AC operation through halve-wave rectifier possible, slight flickering can occur.

Series resistor

for lamp voltage reduction

| | Operating voltage | Typ-Nr. |  |
|--|-------------------|-----------------|---|
| Series resistor 10 kΩ, for filament lamp 48 VAC, 25 mA | 230/240 V | 02-904.7 | 0.003 |
| 2.7 kΩ, for filament lamp 48 VAC, 25 mA | 110 V | 02-904.0 | 0.003 |
| 3.3 kΩ, for filament lamp 48 VAC, 25 mA | 125 V | 02-904.1 | 0.003 |
| 4.7 kΩ, for filament lamp 48 VAC, 25 mA | 145 V | 02-904.3 | 0.003 |



Please keep to the country specific security rules.

Terminal plate empty

for fitting with series resistors

| | Typ-Nr. |  |
|---|-----------------|---|
| Terminal plate empty 10 spaces 125 x 60 x 15 mm | 02-912.2 | 0.045 |
| 15 spaces 187.5 x 60 x 15 mm | 02-912.3 | 0.090 |
| 5 spaces 62.5 x 60 x 15 mm | 02-912.1 | 0.025 |



Assembling

Lens remover

| | Typ-Nr. |  |
|---------------------|---------------|---|
| Lens remover | 02-905 | 0.011 |



Lamp remover

| | Typ-Nr. |  |
|---------------------|------------------|---|
| Lamp remover | 61-9740.0 | 0.003 |



CAUTION

A switching process might be released when replacing the lamp/LED !

Mounting tool

| | Typ-Nr. |  |
|--|---------------|---|
| Mounting tool for Indicator 16 mm dia. | 01-907 | 0.020 |



Dressing tool

for aligning buttons

| | Typ-Nr. |  |
|----------------------|---------------|---|
| Dressing tool | 01-906 | 0.030 |



Actuator with snap-action switching element

Switching system

Self-cleaning, double-break, snap action switching system (with contact gap 2 x 0.5 mm).
 1 Normally closed or 1 Normally open contact per element.
 Snap-action switching elements with soldering terminals at the sides: Up to 4 switching element can be on a pushbutton (max. 4 Normally closed and 4 Normally open contacts).
 Snap-action switching element with axial plug-in terminals 2.8 mm stachable, only 1 switching element can be on a pushbutton.

Material

Material of contact

Gold plated silver

Switch housing

Axial plug-in/soldering terminal 2.8 mm:
 Diallylphthalate (DAP), Polyamide (PA66), Polysulfone, heat-resistant and self-extinguishing
 Soldering terminal: PA 6.6 Ultramide

Actuator housing

Polyetherimide, self-extinguishing

Mechanical characteristics

Terminals

Snap-action switching element with tinned soldering terminals at the sides:
 Max. wire diameter 2 wires à 1.2 mm
 Max. wire cross-section of stranded cable 1 x 1 mm²
 Snap-action switching element with axial plug-in terminals, which can also be used as soldering terminals: Plug-in terminal 2.8 x 0.5 mm

Soldering terminal:

Max. wire diameter 1 wire of 1.5 mm²
 Max. wire cross-section of stranded cable 2 x 0.75 mm² or 1 x 1.0 mm²

Actuating force

2 N ... 5.5 N, depending on the number of switching elements

Actuating travel

3 mm

Rebound time

≤5ms

Mechanical lifetime

Momentary action 2 million cycles of operation
 Maintained action 1 million cycles of operation

Electrical characteristics

Standards

IEC 61058, EN 61058

Rated voltage

250 VAC/VDC

Rated current

5 A

Contact resistance

Starting value (initial) ≤50 mΩ

Conventional free air thermal current

5 A

The maximum current in continuous operation and at ambient temperature not exceeding the quoted maximum values.

Switch rating

250 VAC, 5 A (cosφ 1)
 250 VAC, 3 A (cosφ 0,3)

Switch rating AC (cosφ 0,7)

| | | |
|---------|---------|---------|
| Voltage | 125 VAC | 250 VAC |
| Current | 3 A | 2 A |

Switch rating DC (inductive) L:R = 30 ms

| | | | | |
|---------|--------|--------|---------|---------|
| Voltage | 24 VDC | 60 VDC | 110 VDC | 220 VDC |
| Current | 2 A | 0.7 A | 0.2 A | 0.1 A |

Electric strength

2500 VAC, 50 Hz, 1 min. between all terminals and earth, as per IEC 60512-2-11

Protection class

II

Environmental conditions

Storage temperature

-40 °C ... +85 °C

Service temperature

-25 °C ... +55 °C

For indicators and illuminated pushbuttons mounted as a block, make sure the heat can escape freely.

Protection degree

Front as per:
 IP 40
 IP 65 with spray cover

Shock resistance

(Single impacts, semi-sinusoidal)
 15 g for 11 ms, as per IEC 60512-4-3, IEC 60068-2-27

Vibration resistance

(sinusoidal)
 10 g at 0-2000 Hz, amplitude 1.5 mm, as per IEC 60512-4-4, IEC 60068-2-6

Climate resistance

Standard condition, as per IEC 60068-2-3 and 2-30
 Changing condition, as per IEC 60068-2-14 and 2-33

Approvals

Approbations

CB (IEC 61058)
 CSA
 ENEC (EN 61058)
 Germanischer Lloyd
 UL

Declaration of conformity

CE

Actuator with low level switching element

Switching system

This low level switching element was designed for switching low powers in electronic circuits. The mechanism assures reliable switching of loads ranging from a few $\mu\text{A}/\mu\text{V}$ up to 100 mA/42 VAC/DC.

Single-break momentary contact, as normally open or normally closed with 4 independent points of contact. 2 momentary contacts per switching element; combination of normally open and normally closed is possible.

Special features are the long life, extremely short rebound time and stable contact resistance.

Material

Material of contact

Gold plated

Switch housing

Polysulfone, heat-resistant and self-extinguishing

Actuator housing

Polyetherimide, self-extinguishing

Mechanical characteristics

Terminals

The universal terminals permit these units to be mounted on printed circuit boards (PCB). These terminals can also be used as soldering or plug-in terminals.

For these terminals we can also supply a plug-in base which, when soldered on to the board, enables the switch to be plugged in.

Soldering terminal:

Max. wire diameter 2 wires à 0.8 mm

Max. wire cross-section of stranded cable 1x 0.75 mm²

Plug-in terminal: 2.0 x 0.5 mm

Actuating force

3 N ... 3,5 N

Actuating travel

3 mm

Rebound time

Typ. <100 μs

Mechanical lifetime

Momentary action 5 million cycles of operation

Maintained action 1 million cycles of operation

Electrical characteristics

Standards

EN 61058

Contact resistance

Starting value (initial) $\leq 50 \text{ m}\Omega$

Switch rating

10 μA , 100 μV to 100 mA at 42 VAC/VDC

Electric strength

2500 VAC, 50 Hz, 1 min. between all terminals and earth, as per IEC 60512-2-11

Protection class

II

Environmental conditions

Storage temperature

-40 °C ... +85 °C

Service temperature

-25 °C ... +55 °C

For indicators and illuminated pushbuttons mounted as a block, make sure the heat can escape freely.

Protection degree

Front as per:

IP 40

IP 65 with spray cover

Shock resistance

(Single impacts, semi-sinusoidal)

15 g for 11 ms, as per IEC 60512-4-3, IEC 60068-2-27

Vibration resistance

(sinusoidal)

10 g at 0-2000 Hz, amplitude 1.5 mm, as per IEC 60512-4-4, IEC 60068-2-6

Climate resistance

Standard condition, as per IEC 60068-2-3 and 2-30

Changing condition, as per IEC 60068-2-14 and 2-33

Buzzer Typ-Nr. 31-810.005

Switching system

Buzzer system

Electronic non-contacting buzzer
with IC oscillator

Material

Alarm buzzer case

Polyetherimide

Front bezel

Polyamide

Mechanical characteristics

Terminals

Soldering terminal

Electrical characteristics

Frequency (tone)

Approx. 2.8 kHz

Interval frequency

approx. 3 Hz

Sound pressure

88 dB (A) ± 8 dB at a distance of 0.1 m
Volume variable with a 1 M Ω potentiometer or corresponding fixed resistor

Operation Voltage/Current

Typ. 10 VAC ... 55 VAC, 25 mA
Typ. 10 VDC ... 75 VDC, 15 mA

Environmental conditions

Storage temperature

-40 °C ... +85 °C

Service temperature

-25 °C ... +55 °C

Protection degree

IP 40

Approvals

Approbations

Germanischer Lloyd

Declaration of conformity

CE

Buzzer Typ-Nr. 31-801.002

Switching system

Buzzer system

Electronic non-contacting buzzer
with IC oscillator

Material

Alarm buzzer case

Polyetherimide

Front bezel

Polyamide

Mechanical characteristics

Terminals

Plug-in terminal 2.8 x 0.5 mm

Electrical characteristics

Frequency (tone)

ca. 2.0 kHz

Interval frequency

2 Hz

Sound pressure

88 db (A) ± 8 dB at a distance of 0.1 m

Operation Voltage/Current

10 VDC ... 26 VDC, ≤ 20 mA

Environmental conditions

Storage temperature

-40 °C ... +85 °C

Service temperature

-25 °C ... +55 °C

Protection degree

IP 40

Approvals

Approbations

Germanischer Lloyd

Declaration of conformity

CE

Diode element

When indicators and illuminated pushbuttons equipped with diodes, the user is able to perform a lamp check or wire an alarm circuit simply with a considerable saving of space.

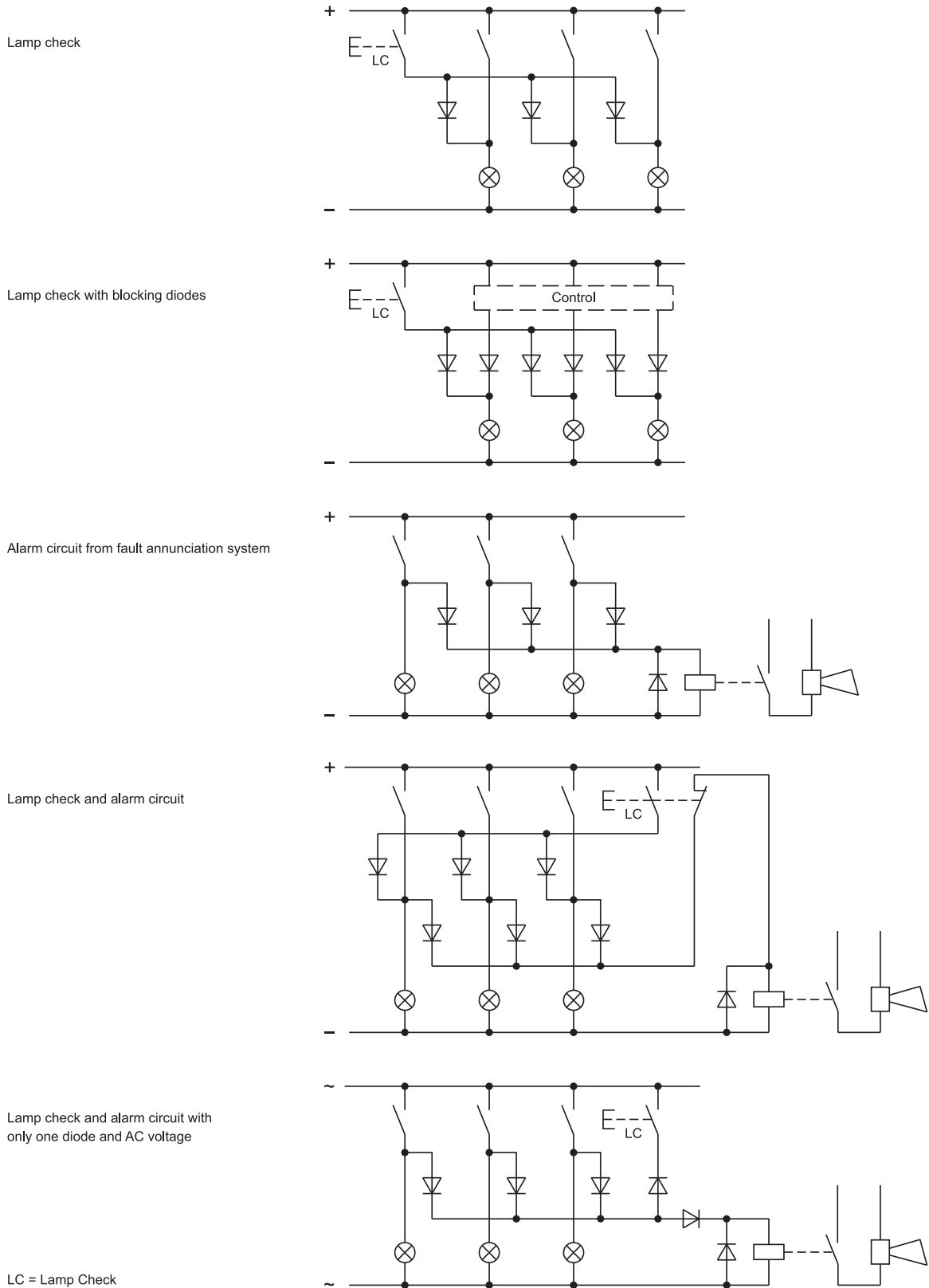

Buzzer (31-801.002)

Depending on how terminals are connected, the buzzer can operate with a continuous tone a(-) b(+) or with intermittent tone a(+) b(-).

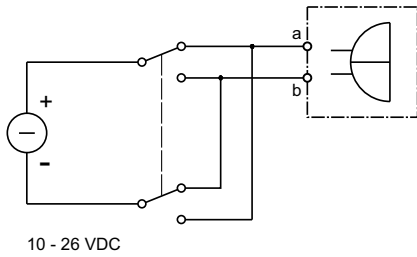

10 - 26 VDC

Buzzer (31-810.005)



1. Supply voltage I
Continuous tone
U = 10 - 35 VAC
U = 10 - 50 VDC

2. Supply voltage II
Continuous tone
U = 35 - 55 VAC
U = 35 - 75 VDC

3. Intermittent tone
Interval aprox. 3 Hz

4. Volume control

Suppressor circuits

When switching inductive loads such as relays, DC motors, and DC solenoids, it is always important to absorb surges (e.g. with a diode) to protect the contacts. When these inductive loads are switched off, a counter emf can severely damage switch contacts and greatly shorten lifetime.

Fig. 1 shows an inductive load with a free-wheeling diode connected in parallel. This free-wheeling diode provides a path for the inductor current to flow when the current is interrupted by the switch. Without this free-wheeling diode, the voltage across the coil will be limited only by dielectric breakdown voltages of the circuit or parasitic elements of the coil. This voltage can be kilovolts in amplitude even when nominal circuit voltages are low (e.g. 12 VDC) see Fig. 2.

The free-wheeling diode should be chosen so that the reverse breakdown voltage is greater than the voltage driving the inductive load. The DC blocking voltage (V_R) of the free-wheeling diode can be found in the datasheet of a diode. The forward current should be equal or greater than the maximum current flowing through the load.

To get an efficient protection, the free-wheeling diode must be connected as close as possible to the inductive load!

Switching with inductive load
Fig. 1



Counter emf
over load without free-wheeling diode
Fig. 2



General notes

1. Engraving

In addition to the most commonly used world languages, in DIN 1451-3 close spacing, other typefaces are available as Scandinavian, Slavic, Greek, Russian and Polish.

Red, blue and black lenses are filled with white colour. Other colour lenses are filled in black. Standard height of letters is 2 mm. If the height is not specified, we will supply 2 mm engraved letters.

2. Hot stamping

For larger series it is worth considering markings by means of hot stamping. We will be pleased to advise you.

For letters and figures, typefaces with 2.5 mm, 3 mm and 4 mm are available.

3. Film inserts

Instead of using engraving the lenses can be fitted with transparent film inserts, as an alternative. For this purpose, though, it is advisable to use transparent lenses.

In the case of use of a smoke-black lens the fitted film becomes readable only if the lamp is on.

To insert the film, the feet of the lens holder have to be pushed together far enough to enable the lens to be lifted off easily.

The film thickness is 0.2 mm.

Important : Consider pushbutton mounting orientation before specifying engraving characters !

All dimensions in mm

| Front size (Lens) | Film insert max. size | Height of letters h | Number of lines | Number of (target value) capital letters per line | Number of (target value) small letters per line | Image |
|--------------------------|-----------------------|---------------------|-----------------|---|---|-------|
| 18 dia. (15.8 dia.) | 12.8 dia. | 2.5 | 3 | 6 | 6 | B4 |
| | | 3.0 | 2 | 5 | 6 | B4 |
| | | 4.0 | 2 | 3 | 4 | B4 |
| | | 5.0 | 1 | 2 | 3 | B4 |
| | | 6.0 | 1 | 2 | 2 | B4 |
| | | 8.0 | 1 | 2 | 2 | B4 |
| 18 x 18 (15.2 x 15.2) | 12.7 x 12.7 | 2.5 | 4 | 7 - 8 | 8 | B3 |
| | | 3.0 | 3 | 6 - 7 | 7 | B3 |
| | | 4.0 | 2 | 4 - 5 | 5 | B3 |
| | | 5.0 | 2 | 3 - 4 | 4 | B3 |
| | | 6.0 | 1 | 3 | 3 - 4 | B3 |
| | | 8.0 | 1 | 2 - 3 | 2 - 3 | B3 |
| 18 x 24 (15.2 x 21.2) | 12.7 x 18.7 | 2.5 | 4 | 11 | 12 | B1 |
| | | | 5 | 7 - 8 | 8 | B2 |
| | | 3.0 | 3 | 9 - 10 | 10 - 11 | B1 |
| | | | 4 | 6 - 7 | 7 | B2 |
| | | 4.0 | 2 | 7 | 7 - 8 | B1 |
| | | | 3 | 4 - 5 | 5 | B2 |
| | | 5.0 | 2 | 5 - 6 | 6 | B1 |
| | | | | 3 - 4 | 4 | B2 |
| | | 6.0 | 1 | 4 - 5 | 5 | B1 |
| | | | 2 | 3 | 3 - 4 | B2 |
| | | 8.0 | 1 | 3 - 4 | 3 - 4 | B1 |
| | | | | 2 - 3 | 2 - 3 | B2 |

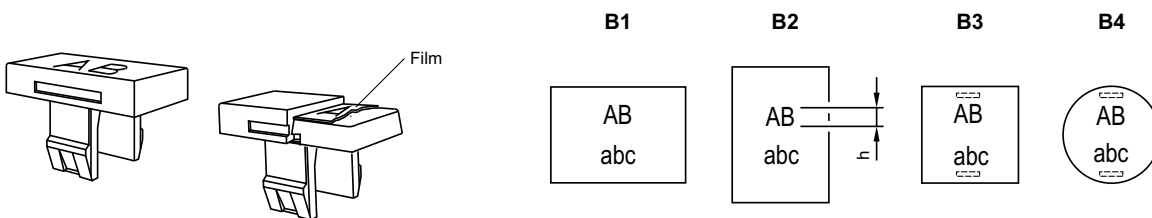

Component layout

1 PCB plug-in base page 9

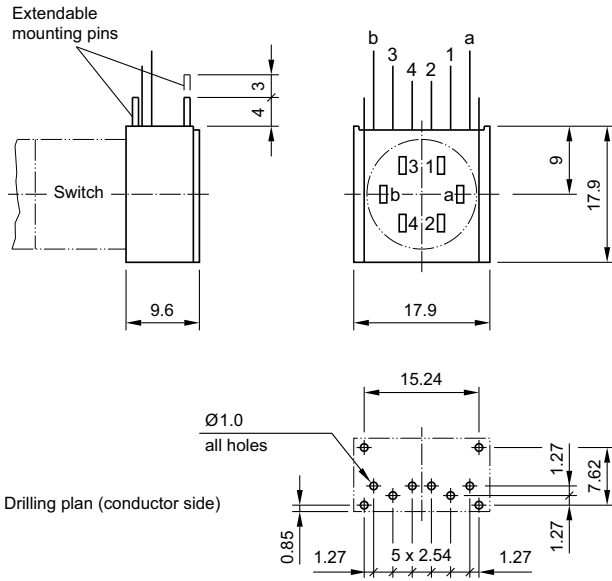

2 PCB plug-in base page 9

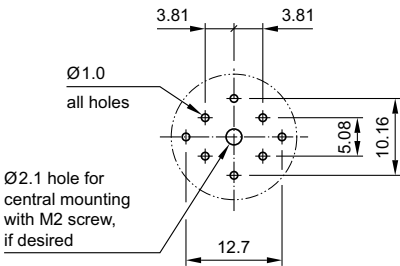

3 PCB plug-in base page 9

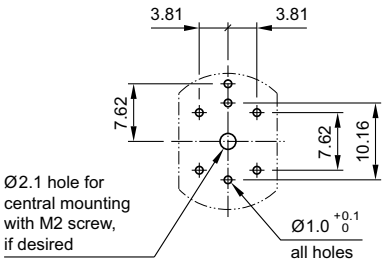

4 Indicator actuator page 5 | Illuminated pushbutton actuator page 6

Terminals (rearside)

PCB layout (conductor side)

18 mm dia.

18 x 18 mm

18 x 24 mm

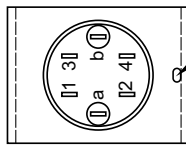
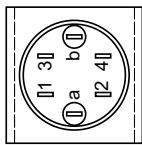
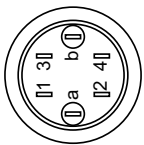

Anti twist device
only 18 x 24 mm

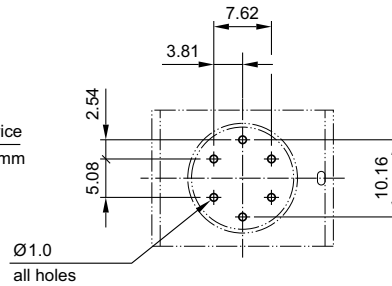

Mounting dimensions

1 Indicator actuator page 5 | Buzzer page 5 | Illuminated pushbutton actuator page 6 | Blind plug page 8

18 x 18 mm

18 x 24 mm

Ø18 mm



2 Front protective cap page 8

18 x 18 mm

18 x 24 mm



Technical drawing

1 Protective guard page 8



2 Protective guard page 8



3 Buzzer page 5



4 Front protective cap page 8



5 Protective cover page 7



6 Protective cover page 7



7 Indicator actuator page 5



| Soldering terminal | Soldering terminal (also pluggable) | Universal terminal | Universal terminal + diodes |
|--------------------|--|--------------------|--------------------------------|
| L | L1 | U | U+D |
| 23.5 | 26.5 | 36 | - |
| 1D, 2D | | | 36 |

8 Illuminated pushbutton actuator page 6



| | Soldering terminal | Soldering terminal (also pluggable) | Universal terminal | Universal terminal + diode |
|-----------------------------|--------------------|--|--------------------|-------------------------------|
| 1NC+1NO | 29 | 36 | - | - |
| 2NC+2NO | 36.5 | - | - | - |
| 3NC+3NO | 44 | - | - | - |
| 4NC+4NO | 51.5 | - | - | - |
| 1NC+1NO+D | - | - | - | 43.5 |
| 2NC+2NO+D | - | - | - | 51 |
| 1NC, 1NO, 1NC+1NO, 2NC, 2NO | 36 | | - | |

Circuit drawing

1 Buzzer page 5



2 Buzzer page 5

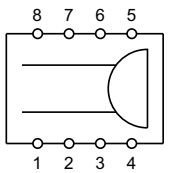

3 Indicator actuator page 5

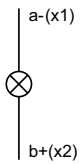

4 Indicator actuator page 5



5 Illuminated pushbutton actuator page 6

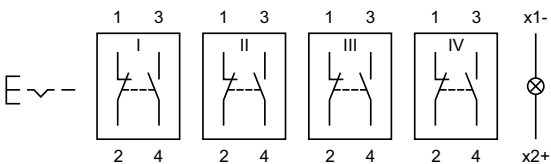

6 Illuminated pushbutton actuator page 6



7 Illuminated pushbutton actuator page 6



8 Illuminated pushbutton actuator page 6

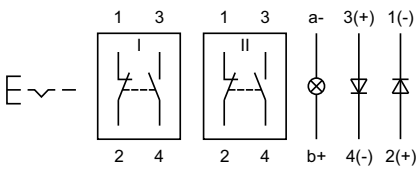

9 Illuminated pushbutton actuator page 6

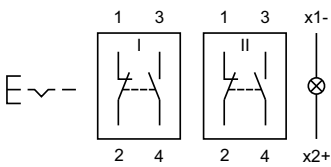

10 Illuminated pushbutton actuator page 6



11 Illuminated pushbutton actuator page 6

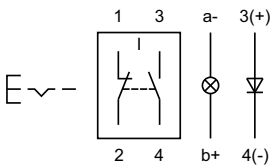

12 Illuminated pushbutton actuator page 6

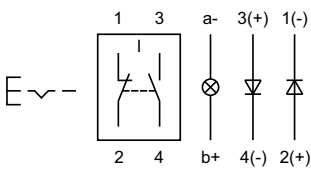

13 Illuminated pushbutton actuator page 6

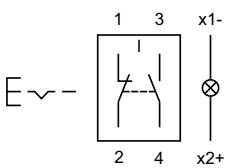

14 Illuminated pushbutton actuator page 6



15 Illuminated pushbutton actuator page 6



16 Illuminated pushbutton actuator page 6

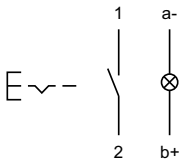

17 Illuminated pushbutton actuator page 6

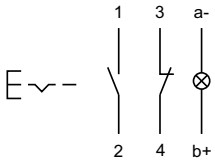

18 Illuminated pushbutton actuator page 6

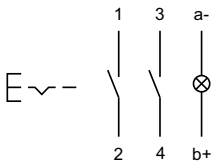

19 Illuminated pushbutton actuator page 6

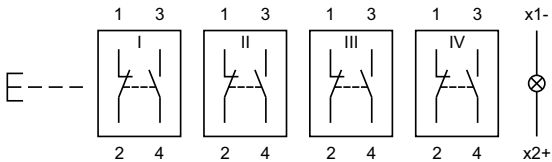

20 Illuminated pushbutton actuator page 6



21 Illuminated pushbutton actuator page 6

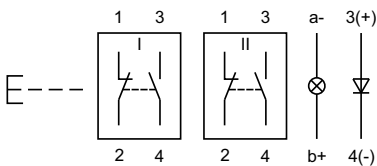

22 Illuminated pushbutton actuator page 6

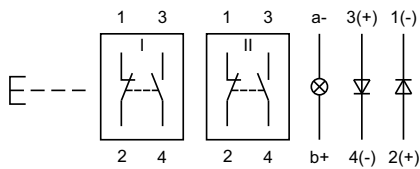

23 Illuminated pushbutton actuator page 6

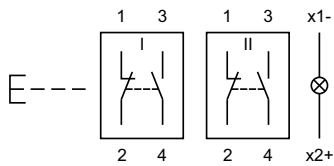

24 Illuminated pushbutton actuator page 6

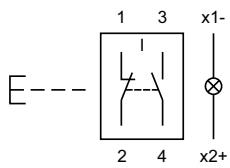

25 Illuminated pushbutton actuator page 6

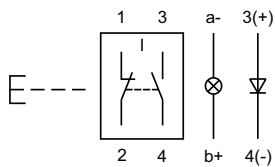

26 Illuminated pushbutton actuator page 6

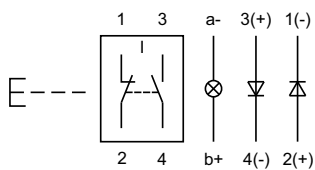

27 Illuminated pushbutton actuator page 6

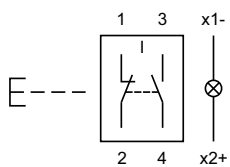

28 Illuminated pushbutton actuator page 6

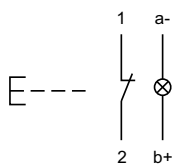

29 Illuminated pushbutton actuator page 6

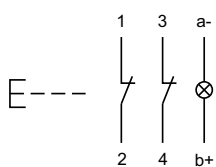

30 Illuminated pushbutton actuator page 6



31 Illuminated pushbutton actuator page 6

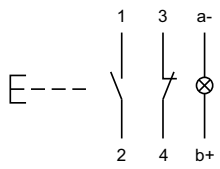

32 Illuminated pushbutton actuator page 6

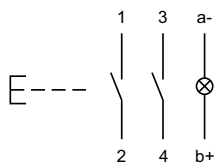

33 Indicator actuator page 5

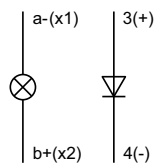

34 Indicator actuator page 5



Index from Typ-Nr.

| Typ-Nr. | Page | Typ-Nr. | Page | Typ-Nr. | Page |
|--------------|------|-------------|------|-------------|------|
| 01-906 | 11 | 31-121.022 | 6 | 31-704.006 | 5 |
| 01-907 | 11 | 31-121.0252 | 6 | 31-705.0292 | 6 |
| 01-926 | 8 | 31-122.0252 | 6 | 31-706.0292 | 6 |
| 01-927 | 8 | 31-123.0252 | 6 | 31-707.0292 | 6 |
| 01-928 | 9 | 31-124.0252 | 6 | 31-708.0292 | 6 |
| 01-929 | 9 | 31-131.022 | 6 | 31-709.0292 | 6 |
| 01-947.0 | 8 | 31-131.0252 | 6 | 31-710.0292 | 6 |
| 01-948.0 | 8 | 31-132.0252 | 6 | 31-711.0292 | 6 |
| 01-949.0 | 8 | 31-133.0252 | 6 | 31-712.0292 | 6 |
| 02-904.0 | 11 | 31-134.0252 | 6 | 31-713.0292 | 6 |
| 02-904.1 | 11 | 31-151.022 | 6 | 31-714.0292 | 6 |
| 02-904.3 | 11 | 31-151.0252 | 6 | 31-715.0292 | 6 |
| 02-904.7 | 11 | 31-152.0252 | 6 | 31-716.0292 | 6 |
| 02-905 | 11 | 31-153.0252 | 6 | 31-717.0292 | 6 |
| 02-912.1 | 11 | 31-154.0252 | 6 | 31-718.0292 | 6 |
| 02-912.2 | 11 | 31-261.022 | 6 | 31-719.0292 | 6 |
| 02-912.3 | 11 | 31-261.0252 | 6 | 31-720.0292 | 6 |
| 10-1306.1349 | 10 | 31-262.0252 | 6 | 31-743.0292 | 6 |
| 10-1307.1369 | 10 | 31-263.0252 | 6 | 31-744.0292 | 6 |
| 10-1309.1309 | 10 | 31-264.0252 | 6 | 31-745.0292 | 6 |
| 10-1310.1319 | 10 | 31-271.022 | 6 | 31-746.0292 | 6 |
| 10-1311.1249 | 10 | 31-271.0252 | 6 | 31-747.0292 | 6 |
| 10-1312.1229 | 10 | 31-272.0252 | 6 | 31-748.0292 | 6 |
| 10-1313.1209 | 10 | 31-273.0252 | 6 | 31-749.0292 | 6 |
| 10-1313.1249 | 10 | 31-274.0252 | 6 | 31-750.0292 | 6 |
| 10-1316.1179 | 10 | 31-281.022 | 6 | 31-801.002 | 5 |
| 10-1316.1209 | 10 | 31-281.0252 | 6 | 31-810.005 | 5 |
| 10-1319.1179 | 10 | 31-282.0252 | 6 | 31-901.0 | 7 |
| 10-1319.1199 | 10 | 31-283.0252 | 6 | 31-901.2 | 7 |
| 10-2J06.3142 | 10 | 31-284.0252 | 6 | 31-901.3 | 7 |
| 10-2J06.3144 | 10 | 31-421.036 | 6 | 31-901.4 | 7 |
| 10-2J06.3145 | 10 | 31-422.036 | 6 | 31-901.5 | 7 |
| 10-2J06.3146 | 10 | 31-423.036 | 6 | 31-901.6 | 7 |
| 10-2J06.3149 | 10 | 31-425.036 | 6 | 31-901.8 | 7 |
| 10-2J09.1062 | 10 | 31-426.036 | 6 | 31-901.9 | 7 |
| 10-2J09.1064 | 10 | 31-431.036 | 6 | 31-902.0 | 7 |
| 10-2J09.1065 | 10 | 31-432.036 | 6 | 31-902.8 | 7 |
| 10-2J09.1066 | 10 | 31-433.036 | 6 | 31-903.1 | 7 |
| 10-2J09.1069 | 10 | 31-435.036 | 6 | 31-903.2 | 7 |
| 10-2J12.1062 | 10 | 31-436.036 | 6 | 31-903.3 | 7 |
| 10-2J12.1064 | 10 | 31-451.036 | 6 | 31-903.4 | 7 |
| 10-2J12.1065 | 10 | 31-452.036 | 6 | 31-903.5 | 7 |
| 10-2J12.1066 | 10 | 31-453.036 | 6 | 31-903.6 | 7 |
| 10-2J12.1069 | 10 | 31-455.036 | 6 | 31-903.7 | 7 |
| 10-2J13.1062 | 10 | 31-456.036 | 6 | 31-904.2 | 7 |
| 10-2J13.1064 | 10 | 31-461.036 | 6 | 31-904.3 | 7 |
| 10-2J13.1065 | 10 | 31-462.036 | 6 | 31-904.4 | 7 |
| 10-2J13.1066 | 10 | 31-463.036 | 6 | 31-904.5 | 7 |
| 10-2J13.1069 | 10 | 31-465.036 | 6 | 31-904.6 | 7 |
| 10-2J19.1042 | 10 | 31-466.036 | 6 | 31-904.7 | 7 |
| 10-2J19.1044 | 10 | 31-471.036 | 6 | 31-905.2 | 7 |
| 10-2J19.1045 | 10 | 31-472.036 | 6 | 31-905.4 | 7 |
| 10-2J19.1046 | 10 | 31-473.036 | 6 | 31-905.5 | 7 |
| 10-2J19.1049 | 10 | 31-475.036 | 6 | 31-905.7 | 7 |
| 31-030.002 | 5 | 31-476.036 | 6 | 31-920 | 7 |
| 31-030.005 | 5 | 31-481.036 | 6 | 31-923 | 8 |
| 31-031.006 | 5 | 31-482.036 | 6 | 31-924.2 | 8 |
| 31-040.002 | 5 | 31-483.036 | 6 | 31-925 | 7 |
| 31-040.005 | 5 | 31-485.036 | 6 | 31-928 | 9 |
| 31-041.006 | 5 | 31-486.036 | 6 | 31-929 | 9 |
| 31-050.002 | 5 | 31-701.006 | 5 | 31-931.0 | 7 |
| 31-050.005 | 5 | 31-702.006 | 5 | 31-931.2 | 7 |
| 31-051.006 | 5 | 31-703.006 | 5 | 31-931.3 | 7 |

Index from Typ-Nr.

| Typ-Nr. | Page | Typ-Nr. | Page | Typ-Nr. | Page |
|-----------|------|---------|------|---------|------|
| 31-931.4 | 7 | | | | |
| 31-931.5 | 7 | | | | |
| 31-931.6 | 7 | | | | |
| 31-931.8 | 7 | | | | |
| 31-931.9 | 7 | | | | |
| 31-933.1 | 7 | | | | |
| 31-933.2 | 7 | | | | |
| 31-933.3 | 7 | | | | |
| 31-933.4 | 7 | | | | |
| 31-933.5 | 7 | | | | |
| 31-933.6 | 7 | | | | |
| 31-933.7 | 7 | | | | |
| 31-935.2 | 7 | | | | |
| 31-935.4 | 7 | | | | |
| 31-935.5 | 7 | | | | |
| 31-935.7 | 7 | | | | |
| 31-940 | 9 | | | | |
| 31-941 | 9 | | | | |
| 31-942 | 9 | | | | |
| 31-945 | 9 | | | | |
| 31-946 | 9 | | | | |
| 31-951.0 | 7 | | | | |
| 31-951.2 | 7 | | | | |
| 31-951.3 | 7 | | | | |
| 31-951.4 | 7 | | | | |
| 31-951.5 | 7 | | | | |
| 31-951.6 | 7 | | | | |
| 31-951.8 | 7 | | | | |
| 31-951.9 | 7 | | | | |
| 31-952.0 | 7 | | | | |
| 31-953.1 | 7 | | | | |
| 31-953.2 | 7 | | | | |
| 31-953.3 | 7 | | | | |
| 31-953.4 | 7 | | | | |
| 31-953.5 | 7 | | | | |
| 31-953.6 | 7 | | | | |
| 31-953.7 | 7 | | | | |
| 31-954.2 | 7 | | | | |
| 31-954.3 | 7 | | | | |
| 31-954.4 | 7 | | | | |
| 31-954.5 | 7 | | | | |
| 31-954.6 | 7 | | | | |
| 31-954.7 | 7 | | | | |
| 31-955.2 | 7 | | | | |
| 31-955.4 | 7 | | | | |
| 31-955.5 | 7 | | | | |
| 31-955.7 | 7 | | | | |
| 61-9740.0 | 11 | | | | |

| | |
|----------------|---|
| | EAO AG |
| | Tannwaldstrasse 88 4601 Olten, Switzerland |
| E-mail | info@eao.com |
| Website | www.eao.com |
| | Austria |
| Phone | +49 201 85 87 0 |
| Fax | +49 201 85 87 210 |
| E-mail | sales.ede@eao.com |
| | Belgium |
| Phone | +32 3 777 82 36 |
| Fax | +32 3 777 84 19 |
| E-mail | sales.ebl@eao.com |
| | China |
| Phone | +852 27 86 91 41 |
| Fax | +852 27 86 95 61 |
| E-mail | sales.ehk@eao.com |
| | France |
| Phone | +33 1 64 43 37 37 |
| Fax | +33 1 64 43 37 49 |
| E-mail | sales.esa@eao.com |
| | Germany |
| Phone | +49 201 85 87 0 |
| Fax | +49 201 85 87 210 |
| E-mail | sales.ede@eao.com |
| | Italy |
| Phone | +39 035 481 0189 |
| Fax | +39 035 481 3786 |
| E-mail | sales.eit@eao.com |
| | Japan |
| Phone | +81 3 5444 5411 |
| Fax | +81 3 5444 0345 |
| E-mail | sales.esj@eao.com |
| | Netherlands |
| Phone | +31 78 653 17 00 |
| Fax | +31 78 653 17 99 |
| E-mail | sales.enl@eao.com |
| | Sweden |
| Phone | +46 8 683 86 60 |
| Fax | +46 8 724 29 12 |
| E-mail | sales.esw@eao.com |
| | Switzerland |
| Phone | +41 62 388 95 00 |
| Fax | +41 62 388 95 55 |
| E-mail | sales.ech@eao.com |
| | United Kingdom |
| Phone | +44 1444 236 000 |
| Fax | +44 1444 236 641 |
| E-mail | sales.euk@eao.com |
| | USA |
| Phone | +1 203 877 4577 |
| Fax | +1 203 877 3694 |
| E-mail | sales.eus@eao.com |
| | Other Countries |
| Phone | +41 62 286 92 10 |
| Fax | +41 62 296 21 62 |
| E-mail | info@eao.com |

Компания «Life Electronics» занимается поставками электронных компонентов импортного и отечественного производства от производителей и со складов крупных дистрибьюторов Европы, Америки и Азии.

С конца 2013 года компания активно расширяет линейку поставок компонентов по направлению коаксиальный кабель, кварцевые генераторы и конденсаторы (керамические, пленочные, электролитические), за счёт заключения дистрибьюторских договоров

Мы предлагаем:

- Конкуренеспособные цены и скидки постоянным клиентам.
- Специальные условия для постоянных клиентов.
- Подбор аналогов.
- Поставку компонентов в любых объемах, удовлетворяющих вашим потребностям.
- Приемлемые сроки поставки, возможна ускоренная поставка.
- Доставку товара в любую точку России и стран СНГ.
- Комплексную поставку.
- Работу по проектам и поставку образцов.
- Формирование склада под заказчика.
- Сертификаты соответствия на поставляемую продукцию (по желанию клиента).
- Тестирование поставляемой продукции.
- Поставку компонентов, требующих военную и космическую приемку.
- Входной контроль качества.
- Наличие сертификата ISO.

В составе нашей компании организован Конструкторский отдел, призванный помогать разработчикам, и инженерам.

Конструкторский отдел помогает осуществить:

- Регистрацию проекта у производителя компонентов.
- Техническую поддержку проекта.
- Защиту от снятия компонента с производства.
- Оценку стоимости проекта по компонентам.
- Изготовление тестовой платы монтаж и пусконаладочные работы.



Тел: +7 (812) 336 43 04 (многоканальный)

Email: org@lifeelectronics.ru