

Part Number: KB2450YW

Yellow

Features

- Uniform light emitting area.
- Low current operation.
- Easily mounted on P.C. boards.
- Flush mountable.
- Excellent on/off contrast.
- Can be used with panels and legend mounts.
- RoHS compliant.

Description

The Yellow source color devices are made with Gallium Arsenide Phosphide on Gallium Phosphide Yellow Light Emitting Diode.

Package Dimensions & Internal Circuit Diagram

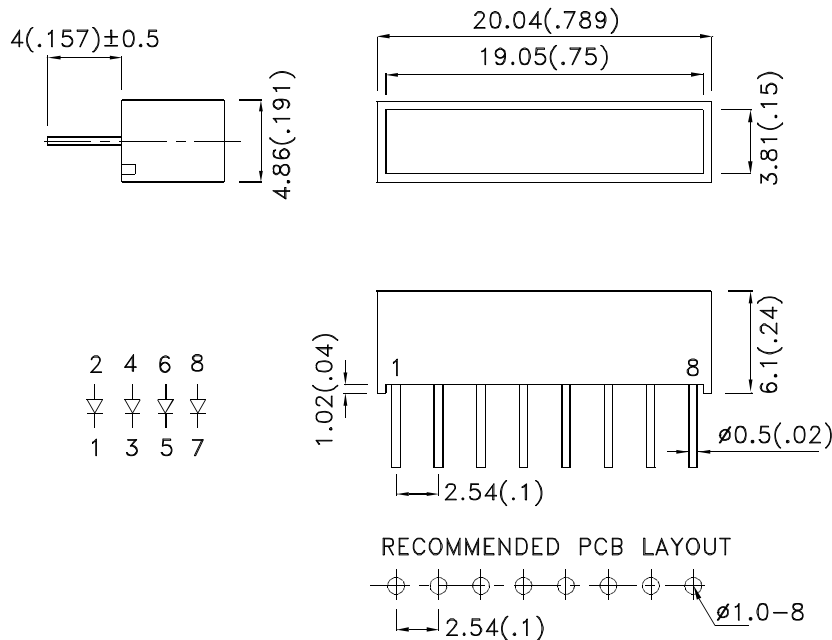

Notes:

1. All dimensions are in millimeters (inches), Tolerance is $\pm 0.25(0.01)$ unless otherwise noted.
2. The specifications, characteristics and technical data described in the datasheet are subject to change without prior notice.



Selection Guide

Part No.	Dice	Lens Type	Iv (mcd) [1] @ 20mA	
			Min.	Typ.
KB2450YW	Yellow (GaAsP/GaP)	White Diffused	12	44

Note:

1. Luminous intensity/ luminous Flux: +/-15%.

Electrical / Optical Characteristics at TA=25°C

Symbol	Parameter	Device	Typ.	Max.	Units	Test Conditions
λ_{peak}	Peak Wavelength	Yellow	590		nm	I _F =20mA
λ_D [1]	Dominant Wavelength	Yellow	588		nm	I _F =20mA
$\Delta\lambda_{1/2}$	Spectral Line Half-width	Yellow	35		nm	I _F =20mA
C	Capacitance	Yellow	20		pF	V _F =0V;f=1MHz
V _F [2]	Forward Voltage	Yellow	2.1	2.5	V	I _F =20mA
I _R	Reverse Current	Yellow		10	uA	V _R =5V

Notes:

1. Wavelength: +/-1nm.
2. Forward Voltage: +/-0.1V.

Absolute Maximum Ratings at TA=25°C

Parameter	Yellow	Units
Power dissipation	75	mW
DC Forward Current	30	mA
Peak Forward Current [1]	140	mA
Reverse Voltage	5	V
Operating / Storage Temperature	-40°C To +85°C	
Lead Solder Temperature[2]	260°C For 3-5 Seconds	

Notes:

1. 1/10 Duty Cycle, 0.1ms Pulse Width.
2. 2mm below package base.



Yellow

KB2450YW

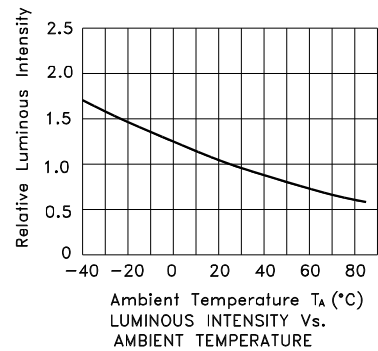
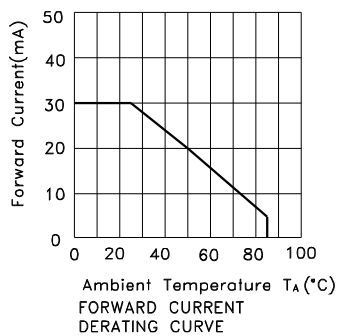
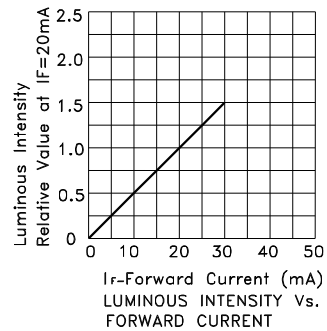
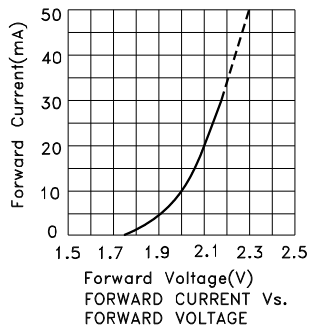

PACKING & LABEL SPECIFICATIONS

KB2450YW

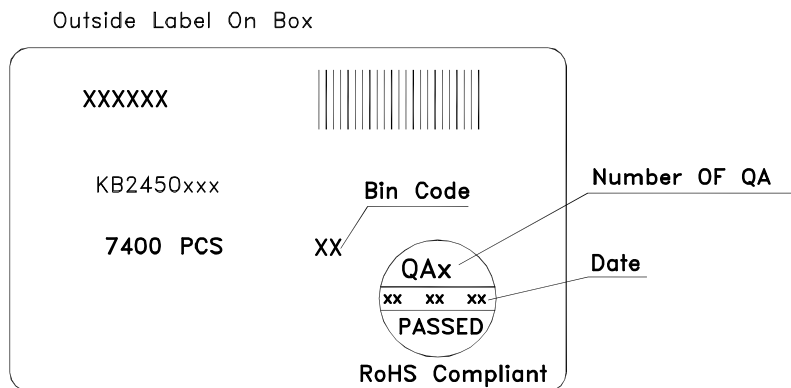
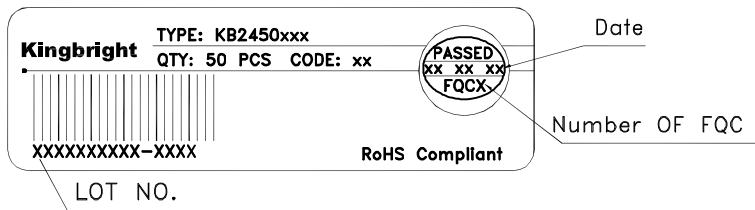
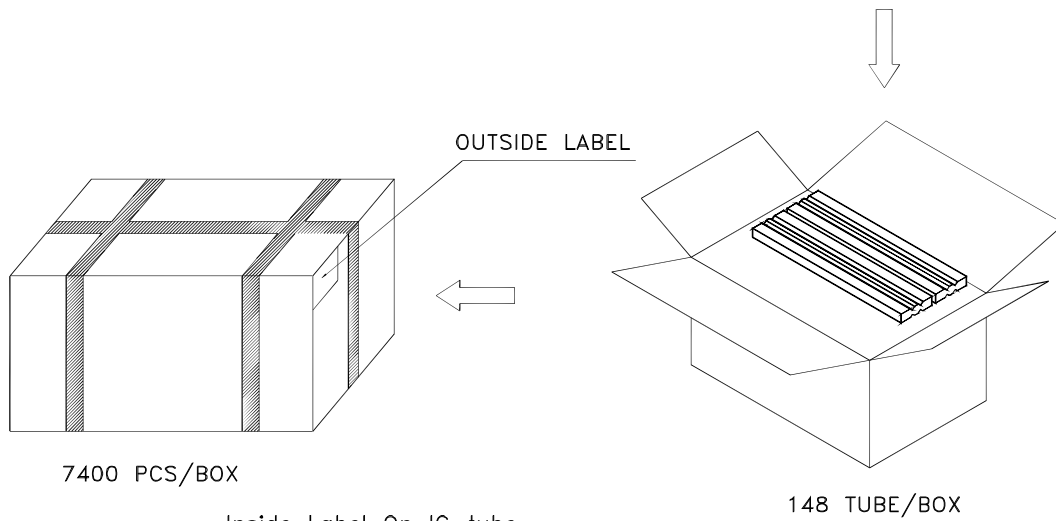
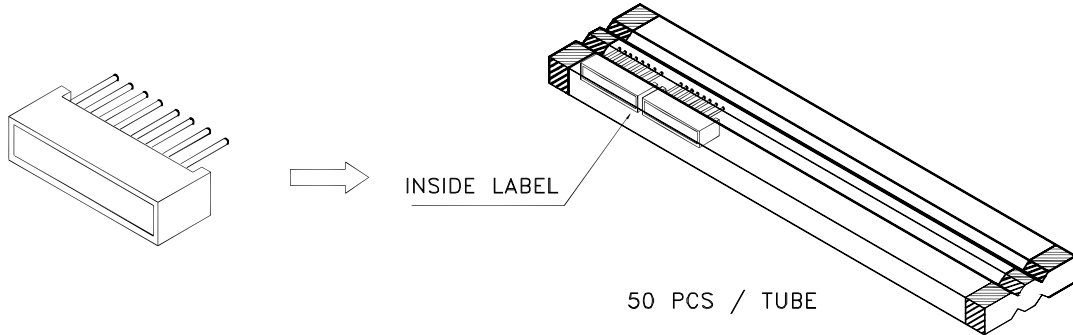

THROUGH HOLE DISPLAY MOUNTING METHOD

Lead Forming

Do not bend the component leads by hand without proper tools.
The leads should be bent by clinching the upper part of the lead firmly such that the bending force is not exerted on the plastic body.



Installation

- 1.The installation process should not apply stress to the lead terminals.
- 2.When inserting for assembly, ensure the terminal pitch matches the substrate board's hole pitch to prevent spreading or pinching the lead terminals.



DISPLAY SOLDERING CONDITIONS

Wave Soldering Profile For Lead-free Through-hole LED.



NOTES:

- 1.Recommend the wave temperature 245°C~260°C.The maximum soldering temperature should be less than 260°C.
- 2.Do not apply stress on epoxy resins when temperature is over 85°C.
- 3.The soldering profile apply to the lead free soldering (Sn/Cu/Ag alloy).
- 4.During wave soldering , the PCB top-surface temperature should be kept below 105°C
- 5.No more than once.

Soldering General Notes:

- a. Through-hole displays are incompatible with reflow soldering.
- b. If components will undergo multiple soldering processes, or other processes where the components may be subjected to intense heat, please check with Kingbright for compatibility.

CLEANING

1. Mild "no-clean" fluxes are recommended for use in soldering.
2. If cleaning is required, Kingbright recommends to wash components with water only. Do not use harsh organic solvents for cleaning, because they may damage the plastic parts. And the devices should not be washed for more than one minute.

CIRCUIT DESIGN NOTES

1. Protective current-limiting resistors may be necessary to operate the Displays.
2. LEDs mounted in parallel should each be placed in series with its own current-limiting resistor.



Компания «Life Electronics» занимается поставками электронных компонентов импортного и отечественного производства от производителей и со складов крупных дистрибьюторов Европы, Америки и Азии.

С конца 2013 года компания активно расширяет линейку поставок компонентов по направлению коаксиальный кабель, кварцевые генераторы и конденсаторы (керамические, пленочные, электролитические), за счёт заключения дистрибьюторских договоров

Мы предлагаем:

- Конкурентоспособные цены и скидки постоянным клиентам.
- Специальные условия для постоянных клиентов.
- Подбор аналогов.
- Поставку компонентов в любых объемах, удовлетворяющих вашим потребностям.
- Приемлемые сроки поставки, возможна ускоренная поставка.
- Доставку товара в любую точку России и стран СНГ.
- Комплексную поставку.
- Работу по проектам и поставку образцов.
- Формирование склада под заказчика.
- Сертификаты соответствия на поставляемую продукцию (по желанию клиента).
- Тестирование поставляемой продукции.
- Поставку компонентов, требующих военную и космическую приемку.
- Входной контроль качества.
- Наличие сертификата ISO.

В составе нашей компании организован Конструкторский отдел, призванный помогать разработчикам, и инженерам.

Конструкторский отдел помогает осуществить:

- Регистрацию проекта у производителя компонентов.
- Техническую поддержку проекта.
- Защиту от снятия компонента с производства.
- Оценку стоимости проекта по компонентам.
- Изготовление тестовой платы монтаж и пусконаладочные работы.



Тел: +7 (812) 336 43 04 (многоканальный)
Email: org@lifeelectronics.ru