

G3VM-61HR1

MOS FET Relays

Higher power, 3.3-A switching
with a 60-V load voltage,
SOP package. Low 30-mΩ
ON Resistance.

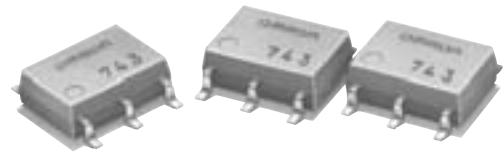

• Continuous load current of 3.3 A. (Connection C: 6.6 A)

Note: The actual product is marked differently from the image shown here.

RoHS compliant

Application Examples

- Communication equipment
- Test & Measurement equipment
- Data loggers
- Industrial equipment

Terminal Arrangement/Internal Connections

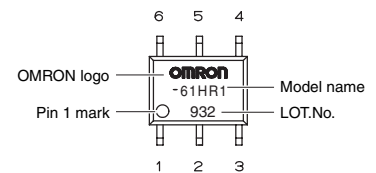
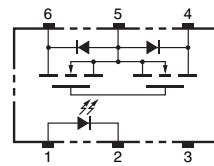

Note: The actual product is marked differently from the image shown here.

List of Models

Package type	Contact form	Terminals	Load voltage (peak value) *	Model	Minimum package quantity	
					Number per tube	Number per tape and reel
SOP6	1a (SPST-NO)	Surface-mounting Terminals	60 V	G3VM-61HR1	75	-
				G3VM-61HR1 (TR05)	-	500

* The AC peak and DC value are given for the load voltage.

Absolute Maximum Ratings (Ta = 25°C)

Item	Symbol	Rating	Unit	Measurement conditions	
Input	LED forward current	IF	30	mA	
	LED forward current reduction rate	ΔIF/°C	-0.3	mA/°C	Ta ≥ 25°C
	LED reverse voltage	VR	5	V	
	Connection temperature	TJ	125	°C	
Output	Load voltage (AC peak/DC)	V _{OFF}	60	V	
	Continuous load current	Connection A	3.3	A	Connection A: AC peak/DC Connection B and C: DC
		Connection B	3.3		
		Connection C	6.6		
	ON current reduction rate	Connection A	-33	mA/°C	Ta ≥ 25°C
		Connection B	-33		
		Connection C	-66		
Pulse ON current	I _{OP}	10	A	t = 100 ms, Duty = 1/10	
Connection temperature	TJ	125	°C		
Dielectric strength between I/O (See note 1.)	V _{I-O}	1500	V _{rms}	AC for 1 min	
Ambient operating temperature	Ta	-40 to +85	°C	With no icing or condensation	
Ambient storage temperature	T _{stg}	-55 to +125	°C	With no icing or condensation	
Soldering temperature	-	260	°C	10 s	

Note: 1. The dielectric strength between the input and output was checked by applying voltage between all pins as a group on the LED side and all pins as a group on the light-receiving side.

Connection Diagram

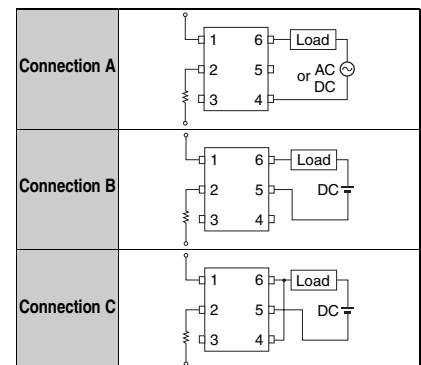

Electrical Characteristics (Ta = 25°C)

Item	Symbol	Minimum	Typical	Maximum	Unit	Measurement conditions	
Input	LED forward voltage	V _F	1.18	1.33	1.48	V	I _F = 10 mA
	Reverse current	I _R	-	-	10	μA	V _R = 5 V
	Capacity between terminals	C _T	-	70	-	pF	V = 0, f = 1 MHz
	Trigger LED forward current	I _{FT}	-	0.2	3	mA	I _O = 2 A
	Turn-OFF LED forward current	I _{FC}	0.1	-	-	mA	I _{OFF} = 10 μA
Output	Maximum resistance with output ON	Connection A	-	30	60	mΩ	I _F = 5 mA, I _O = 2 A, t < 1 s
		Connection B	-	15	-		I _F = 5 mA, I _O = 2 A, t < 1 s
		Connection C	-	8	-		I _F = 5 mA, I _O = 4 A, t < 1 s
	Current leakage when the relay is open	I _{LEAK}	-	-	20	nA	V _{OFF} = 60 V
Capacity between terminals	C _{off}	-	700	1500	pF	V = 0, f = 1 MHz	
Capacity between I/O terminals	C _{I-O}	-	0.8	-	pF	f = 1 MHz, V _s = 0 V	
Insulation resistance between I/O terminals	R _{I-O}	1000	10 ⁸	-	MΩ	V _{I-O} = 500 VDC, R _{oH} ≤ 60 %	
Turn-ON time	t _{ON}	-	0.6	5	ms	I _F = 5 mA, R _L = 200 Ω, V _{DD} = 20 V (See note 2.)	
Turn-OFF time	t _{OFF}	-	0.2	1	ms		

Note: 2. Turn-ON and Turn-OFF Times

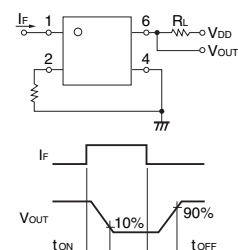

Recommended Operating Conditions

For usage with high reliability, Recommended Operation Conditions is a measure that takes into account the derating of Absolute Maximum Ratings and Electrical Characteristics. Each item on this list is an independent condition, so it is not simultaneously satisfy several conditions.

Item	Symbol	Minimum	Typical	Maximum	Unit
Load voltage (AC peak/DC)	V _{DD}	-	-	48	V
Operating LED forward current	I _F	5	10	25	mA
Continuous load current (AC peak/DC)	I _O	-	-	3.3	A
Ambient operating temperature	T _a	-20	-	65	°C

Engineering Data

LED forward current vs. Ambient temperature

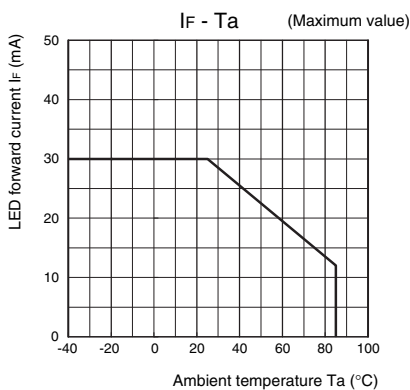

Continuous load current vs. Ambient temperature

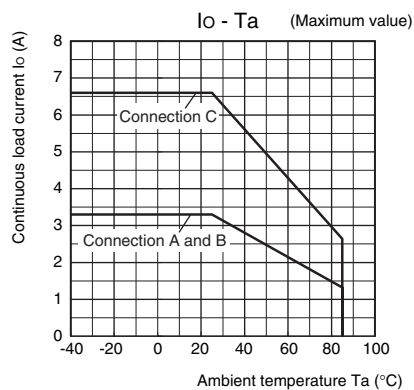

LED forward current vs. LED forward voltage

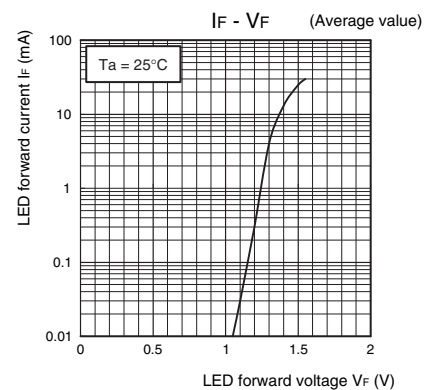

Continuous load current vs. On-state voltage

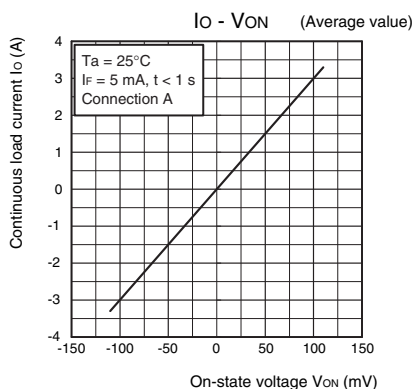

On-state resistance vs. Ambient temperature

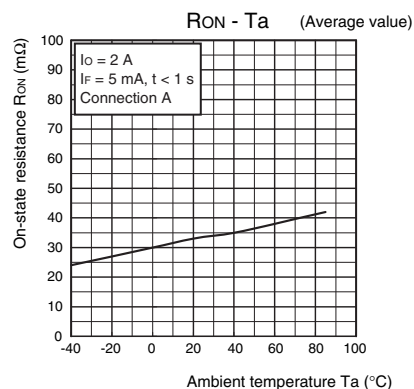

Trigger LED forward current vs. Ambient temperature

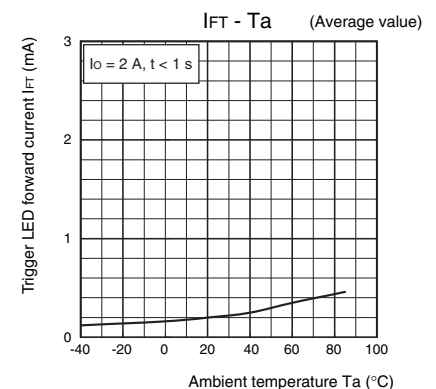

Turn ON, Turn OFF time vs. LED forward current

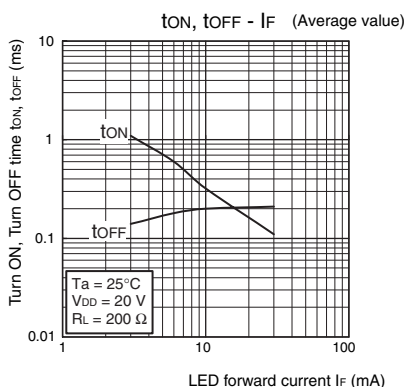

Turn ON, Turn OFF time vs. Ambient temperature

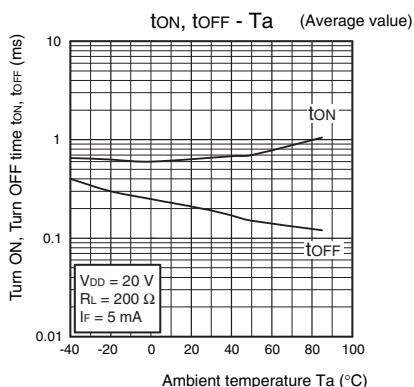

Current leakage vs. Ambient temperature

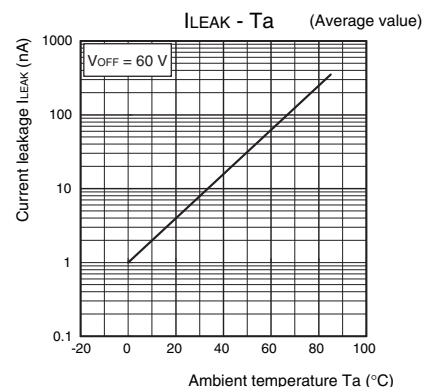

Safety Precautions

- Refer to "Common Precautions" for all G3VM models.

■ Appearance

SOP (Small Outline Package)

SOP6

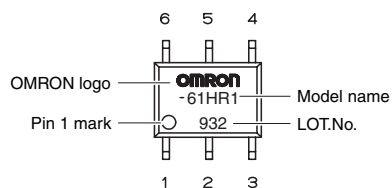

Note: The actual product is marked differently from the image shown here.

■ Dimensions

(Unit: mm)

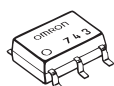

Surface-mounting Terminals

Weight: 0.13 g

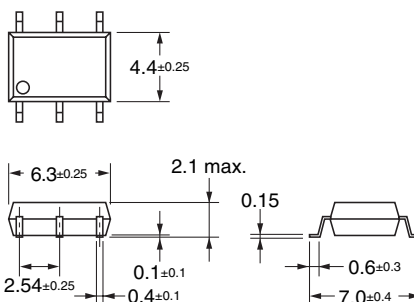

Actual Mounting Pad Dimensions

(Recommended Value, TOP VIEW)

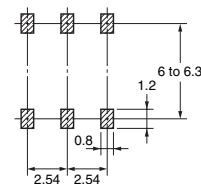

Note: The actual product is marked differently from the image shown here.

- Application examples provided in this document are for reference only. In actual applications, confirm equipment functions and safety before using the product.
- Consult your OMRON representative before using the product under conditions which are not described in the manual or applying the product to nuclear control systems, railroad systems, aviation systems, vehicles, combustion systems, medical equipment, amusement machines, safety equipment, and other systems or equipment that may have a serious influence on lives and property if used improperly. Make sure that the ratings and performance characteristics of the product provide a margin of safety for the system or equipment, and be sure to provide the system or equipment with double safety mechanisms.

Note: Do not use this document to operate the Unit.

Mouser Electronics

Authorized Distributor

Click to View Pricing, Inventory, Delivery & Lifecycle Information:

Omron:

[G3VM-61HR1](#) [G3VM-61HR1\(TR05\)](#)

Компания «Life Electronics» занимается поставками электронных компонентов импортного и отечественного производства от производителей и со складов крупных дистрибьюторов Европы, Америки и Азии.

С конца 2013 года компания активно расширяет линейку поставок компонентов по направлению коаксиальный кабель, кварцевые генераторы и конденсаторы (керамические, пленочные, электролитические), за счёт заключения дистрибьюторских договоров

Мы предлагаем:

- Конкуренеспособные цены и скидки постоянным клиентам.
- Специальные условия для постоянных клиентов.
- Подбор аналогов.
- Поставку компонентов в любых объемах, удовлетворяющих вашим потребностям.
- Приемлемые сроки поставки, возможна ускоренная поставка.
- Доставку товара в любую точку России и стран СНГ.
- Комплексную поставку.
- Работу по проектам и поставку образцов.
- Формирование склада под заказчика.
- Сертификаты соответствия на поставляемую продукцию (по желанию клиента).
- Тестирование поставляемой продукции.
- Поставку компонентов, требующих военную и космическую приемку.
- Входной контроль качества.
- Наличие сертификата ISO.

В составе нашей компании организован Конструкторский отдел, призванный помогать разработчикам, и инженерам.

Конструкторский отдел помогает осуществить:

- Регистрацию проекта у производителя компонентов.
- Техническую поддержку проекта.
- Защиту от снятия компонента с производства.
- Оценку стоимости проекта по компонентам.
- Изготовление тестовой платы монтаж и пусконаладочные работы.



Тел: +7 (812) 336 43 04 (многоканальный)

Email: org@lifeelectronics.ru