

HFA3046, HFA3096, HFA3127, HFA3128

Ultra High Frequency Transistor Arrays

FN3076
Rev.16.00
Jan 24, 2019

The [HFA3046](#), [HFA3096](#), [HFA3127](#) and the [HFA3128](#) are ultra high frequency transistor arrays that are fabricated from the Renesas complementary bipolar UHF-1 process. Each array consists of five dielectrically isolated transistors on a common monolithic substrate. The NPN transistors exhibit a f_T of 8GHz while the PNP transistors provide a f_T of 5.5GHz. Both types exhibit low noise (3.5dB), making them ideal for high frequency amplifier and mixer applications.

The HFA3046 and HFA3127 are all NPN arrays while the HFA3128 has all PNP transistors. The HFA3096 is an NPN-PNP combination. Access is provided to each of the terminals for the individual transistors for maximum application flexibility. Monolithic construction of these transistor arrays provides close electrical and thermal matching of the five transistors.

Application note [AN9315](#) illustrates the use of these devices as RF amplifiers.

Related Literature

For a full list of related documents, visit our website:

- [HFA3046](#), [HFA3096](#), [HFA3127](#), [HFA3128](#) device pages

Features

- NPN transistor (f_T) 8GHz
- NPN current gain (h_{FE}) 130
- NPN early voltage (V_A). 50V
- PNP transistor (f_T) 5.5GHz
- PNP current gain (h_{FE}) 60
- PNP early voltage (V_A). 20V
- Noise figure (50Ω) at 1.0GHz. 3.5dB
- Collector to collector leakage <1pA
- Complete isolation between transistors
- Pin compatible with industry standard 3XXX series arrays
- Pb-free (RoHS compliant)

Applications

- VHF/UHF amplifiers
- VHF/UHF mixers
- IF converters
- Synchronous detectors

Ordering Information

PART NUMBER (Notes 2, 3)	PART MARKING	TEMP. RANGE (°C)	TAPE AND REEL (UNITS) (Note 1)	PACKAGE (RoHS Compliant)	PKG. DWG. #
HFA3046BZ	HFA3046BZ	-55 to +125	-	14 Ld SOIC	M14.15
HFA3096BZ	HFA3096BZ	-55 to +125	-	16 Ld SOIC	M16.15
HFA3096BZ96	HFA3096BZ	-55 to +125	2.5k	16 Ld SOIC	M16.15
HFA3127BZ	HFA3127BZ	-55 to +125	-	16 Ld SOIC	M16.15
HFA3127BZ96	HFA3127BZ	-55 to +125	2.5k	16 Ld SOIC	M16.15
HFA3127RZ	127Z	-55 to +125	-	16 Ld 3x3 QFN	L16.3x3
HFA3127RZ96	127Z	-55 to +125	6k	16 Ld 3x3 QFN	L16.3x3
HFA3128BZ (No longer available or supported)	HFA3128BZ	-55 to +125	-	16 Ld SOIC	M16.15
HFA3128RZ (No longer available or supported)	128Z	-55 to +125	-	16 Ld 3x3 QFN	L16.3x3

NOTE:

1. See [TB347](#) for details about reel specifications.
2. These Pb-free plastic packaged products employ special Pb-free material sets, molding compounds/die attach materials, and 100% matte tin plate plus anneal (e3 termination finish, which is RoHS compliant and compatible with both SnPb and Pb-free soldering operations). Pb-free products are MSL classified at Pb-free peak reflow temperatures that meet or exceed the Pb-free requirements of IPC/JEDEC J STD-020.
3. For Moisture Sensitivity Level (MSL), see the [HFA3046](#), [HFA3096](#), [HFA3127](#), or [HFA3128](#) device page. For more information about MSL, see [TB363](#).

Pinouts

HFA3046
(14 LD SOIC)
TOP VIEW



HFA3096
(16 LD SOIC)
TOP VIEW



HFA3127
(16 LD SOIC)
TOP VIEW



HFA3128
(16 LD SOIC)
TOP VIEW

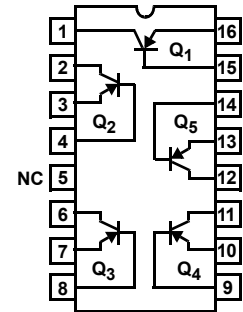

HFA3127, HFA3128
(16 LD 3X3 QFN)
TOP VIEW

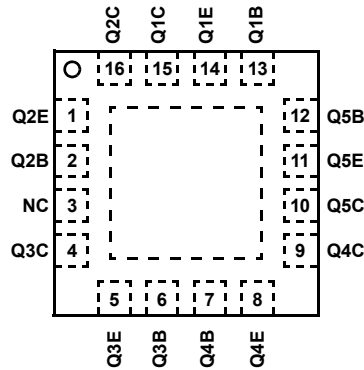

Absolute Maximum Ratings

Collector to Emitter Voltage (Open Base)	8V
Collector to Base Voltage (Open Emitter)	12V
Emitter to Base Voltage (Reverse Bias)	5.5V
Collector Current (100% Duty Cycle)	18.5mA at $T_J = +150^\circ\text{C}$ 34mA at $T_J = +125^\circ\text{C}$ 37mA at $T_J = +110^\circ\text{C}$
Peak Collector Current (Any Condition)	65mA

Operating Information

Temperature Range -55°C to $+125^\circ\text{C}$

Thermal Information

Thermal Resistance (Typical)	θ_{JA} ($^\circ\text{C}/\text{W}$)	θ_{JC} ($^\circ\text{C}/\text{W}$)
14 Ld SOIC Package (Note 4)	120	N/A
16 Ld SOIC Package (Note 4)	115	N/A
QFN Package (Notes 5, 6)	57	10
Maximum Power Dissipation (Any One Transistor)	0.15W	
Maximum Junction Temperature (Die)	$+175^\circ\text{C}$	
Maximum Junction Temperature (Plastic Package)	$+150^\circ\text{C}$	
Maximum Storage Temperature Range	-65°C to $+150^\circ\text{C}$	
Pb-Free Reflow Profile	see TB493	

CAUTION: Stresses above those listed in "Absolute Maximum Ratings" can cause permanent damage to the device. This is a stress only rating and operation of the device at these or any other conditions above those indicated in the operational sections of this specification is not implied.

NOTES:

- θ_{JA} is measured with the component mounted on an evaluation PC board in free air.
- For θ_{JC} , the "case temp" location is the center of the exposed metal pad on the package underside.
- θ_{JA} is measured with the component mounted on a high-effective thermal conductivity test board in free air. See [TB379](#) for details.

Electrical Specifications $T_A = +25^\circ\text{C}$

PARAMETER	TEST CONDITIONS	DIE			SOIC, QFN			UNIT
		MIN	TYP	MAX	MIN	TYP	MAX	
DC NPN CHARACTERISTICS								
Collector to Base Breakdown Voltage, $V_{(BR)CBO}$	$I_C = 100\mu\text{A}$, $I_E = 0$	12	18	-	12	18	-	V
Collector to Emitter Breakdown Voltage, $V_{(BR)CEO}$	$I_C = 100\mu\text{A}$, $I_B = 0$	8	12	-	8	12	-	V
Collector to Emitter Breakdown Voltage, $V_{(BR)CES}$	$I_C = 100\mu\text{A}$, Base Shorted to Emitter	10	20	-	10	20	-	V
Emitter to Base Breakdown Voltage, $V_{(BR)EBO}$	$I_E = 10\mu\text{A}$, $I_C = 0$	5.5	6	-	5.5	6	-	V
Collector-Cutoff-Current, I_{CEO}	$V_{CE} = 6\text{V}$, $I_B = 0$	-	2	100	-	2	100	nA
Collector-Cutoff-Current, I_{CBO}	$V_{CB} = 8\text{V}$, $I_E = 0$	-	0.1	10	-	0.1	10	nA
Collector to Emitter Saturation Voltage, $V_{CE(SAT)}$	$I_C = 10\text{mA}$, $I_B = 1\text{mA}$	-	0.3	0.5	-	0.3	0.5	V
Base to Emitter Voltage, V_{BE}	$I_C = 10\text{mA}$	-	0.85	0.95	-	0.85	0.95	V
DC Forward-Current Transfer Ratio, h_{FE}	$I_C = 10\text{mA}$, $V_{CE} = 2\text{V}$	40	130	-	40	130	-	
Early Voltage, V_A	$I_C = 1\text{mA}$, $V_{CE} = 3.5\text{V}$	20	50	-	20	50	-	V
Base to Emitter Voltage Drift	$I_C = 10\text{mA}$	-	-1.5	-	-	-1.5	-	mV/ $^\circ\text{C}$
Collector to Collector Leakage		-	1	-	-	1	-	pA
DYNAMIC NPN CHARACTERISTICS								
Noise Figure	$f = 1.0\text{GHz}$, $V_{CE} = 5\text{V}$, $I_C = 5\text{mA}$, $Z_S = 50\Omega$	-	3.5	-	-	3.5	-	dB
f_T Current Gain-Bandwidth Product	$I_C = 1\text{mA}$, $V_{CE} = 5\text{V}$	-	5.5	-	-	5.5	-	GHz
	$I_C = 10\text{mA}$, $V_{CE} = 5\text{V}$	-	8	-	-	8	-	GHz
Power Gain-Bandwidth Product, f_{MAX}	$I_C = 10\text{mA}$, $V_{CE} = 5\text{V}$	-	6	-	-	2.5	-	GHz
Base to Emitter Capacitance	$V_{BE} = -3\text{V}$	-	200	-	-	500	-	fF
Collector to Base Capacitance	$V_{CB} = 3\text{V}$	-	200	-	-	500	-	fF

Electrical Specifications $T_A = +25^\circ\text{C}$

PARAMETER	TEST CONDITIONS	DIE			SOIC, QFN			UNITS
		MIN	TYP	MAX	MIN	TYP	MAX	
DC PNP CHARACTERISTICS								
Collector to Base Breakdown Voltage, $V_{(BR)CBO}$	$I_C = -100\mu\text{A}, I_E = 0$	10	15	-	10	15	-	V
Collector to Emitter Breakdown Voltage, $V_{(BR)CEO}$	$I_C = -100\mu\text{A}, I_B = 0$	8	15	-	8	15	-	V
Collector to Emitter Breakdown Voltage, $V_{(BR)CES}$	$I_C = -100\mu\text{A}$, Base Shorted to Emitter	10	15	-	10	15	-	V
Emitter to Base Breakdown Voltage, $V_{(BR)EBO}$	$I_E = -10\mu\text{A}, I_C = 0$	4.5	5	-	4.5	5	-	V
Collector Cutoff Current, I_{CEO}	$V_{CE} = -6\text{V}, I_B = 0$	-	2	100	-	2	100	nA
Collector Cutoff Current, I_{CBO}	$V_{CB} = -8\text{V}, I_E = 0$	-	0.1	10	-	0.1	10	nA
Collector to Emitter Saturation Voltage, $V_{CE(SAT)}$	$I_C = -10\text{mA}, I_B = -1\text{mA}$	-	0.3	0.5	-	0.3	0.5	V
Base to Emitter Voltage, V_{BE}	$I_C = -10\text{mA}$	-	0.85	0.95	-	0.85	0.95	V
DC Forward-Current Transfer Ratio, h_{FE}	$I_C = -10\text{mA}, V_{CE} = -2\text{V}$	20	60	-	20	60	-	
Early Voltage, V_A	$I_C = -1\text{mA}, V_{CE} = -3.5\text{V}$	10	20	-	10	20	-	V
Base to Emitter Voltage Drift	$I_C = -10\text{mA}$	-	-1.5	-	-	-1.5	-	$\text{mV}/^\circ\text{C}$
Collector to Collector Leakage		-	1	-	-	1	-	pA
DYNAMIC PNP CHARACTERISTICS								
Noise Figure	$f = 1.0\text{GHz}, V_{CE} = -5\text{V}, I_C = -5\text{mA}, Z_S = 50\Omega$	-	3.5	-	-	3.5	-	dB
f_T Current Gain-Bandwidth Product	$I_C = -1\text{mA}, V_{CE} = -5\text{V}$	-	2	-	-	2	-	GHz
	$I_C = -10\text{mA}, V_{CE} = -5\text{V}$	-	5.5	-	-	5.5	-	GHz
Power Gain-Bandwidth Product	$I_C = -10\text{mA}, V_{CE} = -5\text{V}$	-	3	-	-	2	-	GHz
Base to Emitter Capacitance	$V_{BE} = 3\text{V}$	-	200	-	-	500	-	fF
Collector to Base Capacitance	$V_{CB} = -3\text{V}$	-	300	-	-	600	-	fF

Common Emitter S-Parameters of NPN $3\mu\text{m} \times 50\mu\text{m}$ Transistor

FREQ. (Hz)	$ S_{11} $	PHASE(S_{11})	$ S_{21} $	PHASE(S_{21})	$ S_{12} $	PHASE(S_{12})	$ S_{22} $	PHASE(S_{22})
$V_{CE} = 5\text{V}$ and $I_C = 5\text{mA}$								
1.0E+08	0.83	-11.78	11.07	168.57	1.41E-02	78.88	0.97	-11.05
2.0E+08	0.79	-22.82	10.51	157.89	2.69E-02	68.63	0.93	-21.35
3.0E+08	0.73	-32.64	9.75	148.44	3.75E-02	59.58	0.86	-30.44
4.0E+08	0.67	-41.08	8.91	140.36	4.57E-02	51.90	0.79	-38.16
5.0E+08	0.61	-48.23	8.10	133.56	5.19E-02	45.50	0.73	-44.59
6.0E+08	0.55	-54.27	7.35	127.88	5.65E-02	40.21	0.67	-49.93
7.0E+08	0.50	-59.41	6.69	123.10	6.00E-02	35.82	0.62	-54.37
8.0E+08	0.46	-63.81	6.11	119.04	6.27E-02	32.15	0.57	-58.10
9.0E+08	0.42	-67.63	5.61	115.57	6.47E-02	29.07	0.53	-61.25
1.0E+09	0.39	-70.98	5.17	112.55	6.63E-02	26.45	0.50	-63.96

Common Emitter S-Parameters of NPN 3 μ m x 50 μ m Transistor (Continued)

FREQ. (Hz)	S ₁₁	PHASE(S ₁₁)	S ₂₁	PHASE(S ₂₁)	S ₁₂	PHASE(S ₁₂)	S ₂₂	PHASE(S ₂₂)
1.1E+09	0.36	-73.95	4.79	109.91	6.75E-02	24.19	0.47	-66.31
1.2E+09	0.34	-76.62	4.45	107.57	6.85E-02	22.24	0.45	-68.37
1.3E+09	0.32	-79.04	4.15	105.47	6.93E-02	20.53	0.43	-70.19
1.4E+09	0.30	-81.25	3.89	103.57	7.00E-02	19.02	0.41	-71.83
1.5E+09	0.28	-83.28	3.66	101.84	7.05E-02	17.69	0.40	-73.31
1.6E+09	0.27	-85.17	3.45	100.26	7.10E-02	16.49	0.39	-74.66
1.7E+09	0.25	-86.92	3.27	98.79	7.13E-02	15.41	0.38	-75.90
1.8E+09	0.24	-88.57	3.10	97.43	7.17E-02	14.43	0.37	-77.05
1.9E+09	0.23	-90.12	2.94	96.15	7.19E-02	13.54	0.36	-78.12
2.0E+09	0.22	-91.59	2.80	94.95	7.21E-02	12.73	0.35	-79.13
2.1E+09	0.21	-92.98	2.68	93.81	7.23E-02	11.98	0.35	-80.09
2.2E+09	0.20	-94.30	2.56	92.73	7.25E-02	11.29	0.34	-80.99
2.3E+09	0.20	-95.57	2.45	91.70	7.27E-02	10.64	0.34	-81.85
2.4E+09	0.19	-96.78	2.35	90.72	7.28E-02	10.05	0.33	-82.68
2.5E+09	0.18	-97.93	2.26	89.78	7.29E-02	9.49	0.33	-83.47
2.6E+09	0.18	-99.05	2.18	88.87	7.30E-02	8.96	0.33	-84.23
2.7E+09	0.17	-100.12	2.10	88.00	7.31E-02	8.47	0.33	-84.97
2.8E+09	0.17	-101.15	2.02	87.15	7.31E-02	8.01	0.33	-85.68
2.9E+09	0.16	-102.15	1.96	86.33	7.32E-02	7.57	0.33	-86.37
3.0E+09	0.16	-103.11	1.89	85.54	7.32E-02	7.16	0.33	-87.05
V_{CE} = 5V and I_C = 10mA								
1.0E+08	0.72	-16.43	15.12	165.22	1.27E-02	75.41	0.95	-14.26
2.0E+08	0.67	-31.26	13.90	152.04	2.34E-02	62.89	0.88	-26.95
3.0E+08	0.60	-43.76	12.39	141.18	3.13E-02	52.58	0.79	-37.31
4.0E+08	0.53	-54.00	10.92	132.57	3.68E-02	44.50	0.70	-45.45
5.0E+08	0.47	-62.38	9.62	125.78	4.05E-02	38.23	0.63	-51.77
6.0E+08	0.42	-69.35	8.53	120.37	4.31E-02	33.34	0.57	-56.72
7.0E+08	0.37	-75.26	7.62	116.00	4.49E-02	29.47	0.51	-60.65
8.0E+08	0.34	-80.36	6.86	112.39	4.63E-02	26.37	0.47	-63.85
9.0E+08	0.31	-84.84	6.22	109.36	4.72E-02	23.84	0.44	-66.49
1.0E+09	0.29	-88.83	5.69	106.77	4.80E-02	21.75	0.41	-68.71
1.1E+09	0.27	-92.44	5.23	104.51	4.86E-02	20.00	0.39	-70.62
1.2E+09	0.25	-95.73	4.83	102.53	4.90E-02	18.52	0.37	-72.28
1.3E+09	0.24	-98.75	4.49	100.75	4.94E-02	17.25	0.35	-73.76
1.4E+09	0.22	-101.55	4.19	99.16	4.97E-02	16.15	0.34	-75.08
1.5E+09	0.21	-104.15	3.93	97.70	4.99E-02	15.19	0.33	-76.28
1.6E+09	0.20	-106.57	3.70	96.36	5.01E-02	14.34	0.32	-77.38
1.7E+09	0.20	-108.85	3.49	95.12	5.03E-02	13.60	0.31	-78.41
1.8E+09	0.19	-110.98	3.30	93.96	5.05E-02	12.94	0.31	-79.37
1.9E+09	0.18	-113.00	3.13	92.87	5.06E-02	12.34	0.30	-80.27

Common Emitter S-Parameters of NPN 3 μ m x 50 μ m Transistor (Continued)

FREQ. (Hz)	S ₁₁	PHASE(S ₁₁)	S ₂₁	PHASE(S ₂₁)	S ₁₂	PHASE(S ₁₂)	S ₂₂	PHASE(S ₂₂)
2.0E+09	0.18	-114.90	2.98	91.85	5.07E-02	11.81	0.30	-81.13
2.1E+09	0.17	-116.69	2.84	90.87	5.08E-02	11.33	0.30	-81.95
2.2E+09	0.17	-118.39	2.72	89.94	5.09E-02	10.89	0.29	-82.74
2.3E+09	0.16	-120.01	2.60	89.06	5.10E-02	10.50	0.29	-83.50
2.4E+09	0.16	-121.54	2.49	88.21	5.11E-02	10.13	0.29	-84.24
2.5E+09	0.16	-122.99	2.39	87.39	5.12E-02	9.80	0.29	-84.95
2.6E+09	0.15	-124.37	2.30	86.60	5.12E-02	9.49	0.29	-85.64
2.7E+09	0.15	-125.69	2.22	85.83	5.13E-02	9.21	0.29	-86.32
2.8E+09	0.15	-126.94	2.14	85.09	5.13E-02	8.95	0.29	-86.98
2.9E+09	0.15	-128.14	2.06	84.36	5.14E-02	8.71	0.29	-87.62
3.0E+09	0.14	-129.27	1.99	83.66	5.15E-02	8.49	0.29	-88.25

Common Emitter S-Parameters of PNP 3 μ m x 50 μ m Transistor

FREQ. (Hz)	S ₁₁	PHASE(S ₁₁)	S ₂₁	PHASE(S ₂₁)	S ₁₂	PHASE(S ₁₂)	S ₂₂	PHASE(S ₂₂)
V_{CE} = -5V and I_C = -5mA								
1.0E+08	0.72	-16.65	10.11	166.77	1.66E-02	77.18	0.96	-10.76
2.0E+08	0.68	-32.12	9.44	154.69	3.10E-02	65.94	0.90	-20.38
3.0E+08	0.62	-45.73	8.57	144.40	4.23E-02	56.39	0.82	-28.25
4.0E+08	0.57	-57.39	7.68	135.95	5.05E-02	48.66	0.74	-34.31
5.0E+08	0.52	-67.32	6.86	129.11	5.64E-02	42.52	0.67	-38.81
6.0E+08	0.47	-75.83	6.14	123.55	6.07E-02	37.66	0.61	-42.10
7.0E+08	0.43	-83.18	5.53	118.98	6.37E-02	33.79	0.55	-44.47
8.0E+08	0.40	-89.60	5.01	115.17	6.60E-02	30.67	0.51	-46.15
9.0E+08	0.38	-95.26	4.56	111.94	6.77E-02	28.14	0.47	-47.33
1.0E+09	0.36	-100.29	4.18	109.17	6.91E-02	26.06	0.44	-48.15
1.1E+09	0.34	-104.80	3.86	106.76	7.01E-02	24.33	0.41	-48.69
1.2E+09	0.33	-108.86	3.58	104.63	7.09E-02	22.89	0.39	-49.05
1.3E+09	0.32	-112.53	3.33	102.72	7.16E-02	21.67	0.37	-49.26
1.4E+09	0.30	-115.86	3.12	101.01	7.22E-02	20.64	0.36	-49.38
1.5E+09	0.30	-118.90	2.92	99.44	7.27E-02	19.76	0.34	-49.43
1.6E+09	0.29	-121.69	2.75	98.01	7.32E-02	19.00	0.33	-49.44
1.7E+09	0.28	-124.24	2.60	96.68	7.35E-02	18.35	0.32	-49.43
1.8E+09	0.28	-126.59	2.47	95.44	7.39E-02	17.79	0.31	-49.40
1.9E+09	0.27	-128.76	2.34	94.29	7.42E-02	17.30	0.30	-49.38
2.0E+09	0.27	-130.77	2.23	93.19	7.45E-02	16.88	0.30	-49.36
2.1E+09	0.26	-132.63	2.13	92.16	7.47E-02	16.52	0.29	-49.35
2.2E+09	0.26	-134.35	2.04	91.18	7.50E-02	16.20	0.28	-49.35
2.3E+09	0.26	-135.96	1.95	90.24	7.52E-02	15.92	0.28	-49.38
2.4E+09	0.25	-137.46	1.87	89.34	7.55E-02	15.68	0.28	-49.42

Common Emitter S-Parameters of PNP 3 μ m \times 50 μ m Transistor (Continued)

FREQ. (Hz)	S ₁₁	PHASE(S ₁₁)	S ₂₁	PHASE(S ₂₁)	S ₁₂	PHASE(S ₁₂)	S ₂₂	PHASE(S ₂₂)
2.5E+09	0.25	-138.86	1.80	88.48	7.57E-02	15.48	0.27	-49.49
2.6E+09	0.25	-140.17	1.73	87.65	7.59E-02	15.30	0.27	-49.56
2.7E+09	0.25	-141.39	1.67	86.85	7.61E-02	15.15	0.26	-49.67
2.8E+09	0.25	-142.54	1.61	86.07	7.63E-02	15.01	0.26	-49.81
2.9E+09	0.24	-143.62	1.56	85.31	7.65E-02	14.90	0.26	-49.96
3.0E+09	0.24	-144.64	1.51	84.58	7.67E-02	14.81	0.26	-50.13
V_{CE} = -5V, I_C = -10mA								
1.0E+08	0.58	-23.24	13.03	163.45	1.43E-02	73.38	0.93	-13.46
2.0E+08	0.53	-44.07	11.75	149.11	2.58E-02	60.43	0.85	-24.76
3.0E+08	0.48	-61.50	10.25	137.78	3.38E-02	50.16	0.74	-33.10
4.0E+08	0.43	-75.73	8.88	129.12	3.90E-02	42.49	0.65	-38.83
5.0E+08	0.40	-87.36	7.72	122.49	4.25E-02	36.81	0.58	-42.63
6.0E+08	0.37	-96.94	6.78	117.33	4.48E-02	32.59	0.51	-45.07
7.0E+08	0.35	-104.92	6.01	113.22	4.64E-02	29.39	0.47	-46.60
8.0E+08	0.33	-111.64	5.39	109.85	4.76E-02	26.94	0.43	-47.49
9.0E+08	0.32	-117.36	4.87	107.05	4.85E-02	25.04	0.40	-47.97
1.0E+09	0.31	-122.27	4.44	104.66	4.92E-02	23.55	0.37	-48.18
1.1E+09	0.30	-126.51	4.07	102.59	4.97E-02	22.37	0.35	-48.20
1.2E+09	0.30	-130.21	3.76	100.76	5.02E-02	21.44	0.33	-48.11
1.3E+09	0.29	-133.46	3.49	99.14	5.06E-02	20.70	0.32	-47.95
1.4E+09	0.29	-136.33	3.25	97.67	5.09E-02	20.11	0.31	-47.77
1.5E+09	0.28	-138.89	3.05	96.33	5.12E-02	19.65	0.30	-47.58
1.6E+09	0.28	-141.17	2.87	95.10	5.15E-02	19.29	0.29	-47.39
1.7E+09	0.28	-143.21	2.70	93.96	5.18E-02	19.01	0.28	-47.23
1.8E+09	0.28	-145.06	2.56	92.90	5.21E-02	18.80	0.27	-47.09
1.9E+09	0.27	-146.73	2.43	91.90	5.23E-02	18.65	0.27	-46.98
2.0E+09	0.27	-148.26	2.31	90.95	5.26E-02	18.55	0.26	-46.91
2.1E+09	0.27	-149.65	2.20	90.05	5.28E-02	18.49	0.26	-46.87
2.2E+09	0.27	-150.92	2.10	89.20	5.30E-02	18.46	0.25	-46.87
2.3E+09	0.27	-152.10	2.01	88.37	5.33E-02	18.47	0.25	-46.90
2.4E+09	0.27	-153.18	1.93	87.59	5.35E-02	18.50	0.25	-46.97
2.5E+09	0.27	-154.17	1.86	86.82	5.38E-02	18.55	0.24	-47.07
2.6E+09	0.26	-155.10	1.79	86.09	5.40E-02	18.62	0.24	-47.18
2.7E+09	0.26	-155.96	1.72	85.38	5.42E-02	18.71	0.24	-47.34
2.8E+09	0.26	-156.76	1.66	84.68	5.45E-02	18.80	0.24	-47.55
2.9E+09	0.26	-157.51	1.60	84.01	5.47E-02	18.91	0.24	-47.76
3.0E+09	0.26	-158.21	1.55	83.35	5.50E-02	19.03	0.23	-48.00

Typical Performance Curves



FIGURE 1. NPN COLLECTOR CURRENT vs COLLECTOR TO EMITTER VOLTAGE

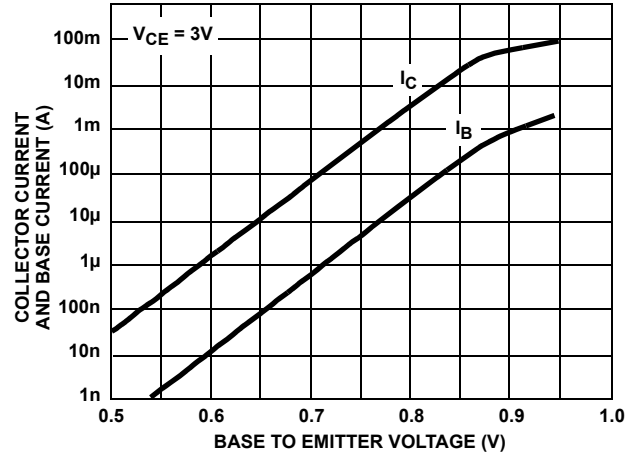

FIGURE 2. NPN COLLECTOR CURRENT AND BASE CURRENT vs BASE TO EMITTER VOLTAGE



FIGURE 3. NPN DC CURRENT GAIN vs COLLECTOR CURRENT

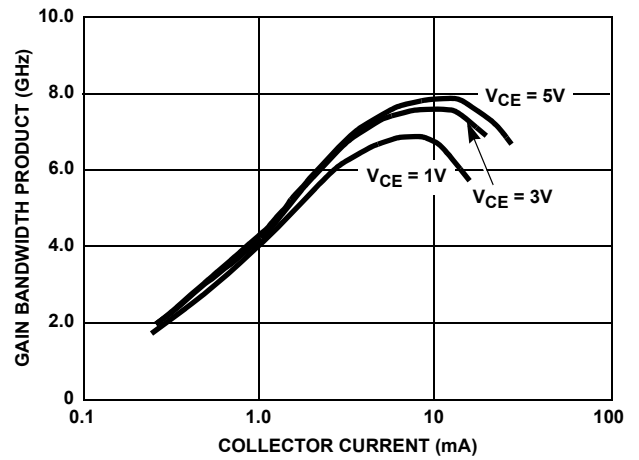

FIGURE 4. NPN GAIN BANDWIDTH PRODUCT vs COLLECTOR CURRENT (UHF 3 x 50 WITH BOND PADS)

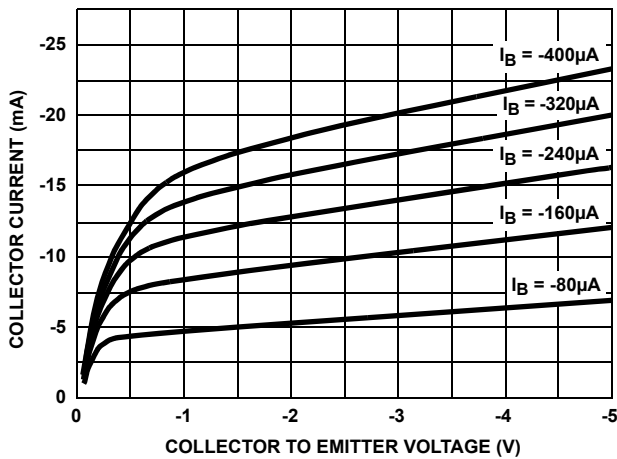

FIGURE 5. PNP COLLECTOR CURRENT vs COLLECTOR TO EMITTER VOLTAGE

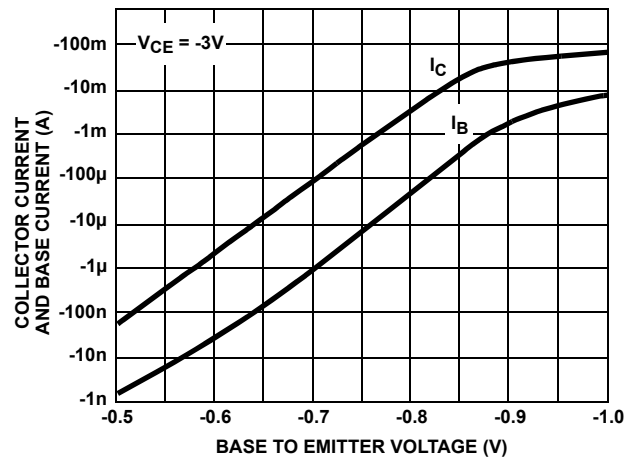

FIGURE 6. PNP COLLECTOR CURRENT AND BASE CURRENT vs BASE TO EMITTER VOLTAGE

Typical Performance Curves (Continued)



FIGURE 7. PNP DC CURRENT GAIN vs COLLECTOR CURRENT



FIGURE 8. PNP GAIN BANDWIDTH PRODUCT vs COLLECTOR CURRENT (UHF 3 x 50 WITH BOND PADS)

Die Characteristics

DIE DIMENSIONS:

53 mils x 52 mils
 1340 μ m x 1320 μ m

METALLIZATION:

Type: Metal 1: AlCu(2%)/TiW
 Thickness: Metal 1: 8k \AA \pm 0.4k \AA
 Type: Metal 2: AlCu(2%)
 Thickness: Metal 2: 16k \AA \pm 0.8k \AA

PASSIVATION:

Type: Nitride
 Thickness: 4k \AA \pm 0.5k \AA

PROCESS:

UHF-1

SUBSTRATE POTENTIAL: (POWERED UP)

Unbiased

Metallization Mask Layout

HFA3096, HFA3127, HFA3128



HFA3046



Pad numbers correspond to SOIC pinout.

Revision History The revision history provided is for informational purposes only and is believed to be accurate, but not warranted. Please go to the web to make sure that you have the latest revision.

DATE	REVISION	CHANGE
Jan 24, 2019	FN3076.16	Added Related Literature section. Updated ordering information table by adding tape and reel versions, and updating notes. Updated links throughout document. Updated POD M16.15 to the latest revision, changes are as follows: -Update graphics to new standard layout, removing the dimension table. Updated disclaimer.
Aug 11, 2015	FN3076.15	Added Revision History beginning with Rev 15. Updated ordering information table with "No longer available or supported" next to HFA3128 part numbers

Package Outline Drawings

For the most recent package outline drawing, see [M14.15](#).

M14.15

14 LEAD NARROW BODY SMALL OUTLINE PLASTIC PACKAGE

Rev 1, 10/09

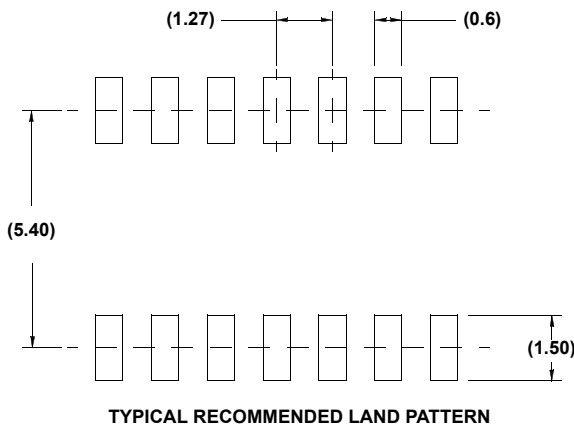
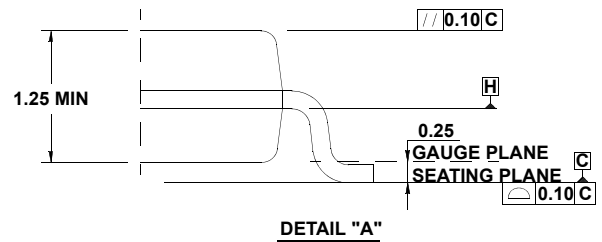
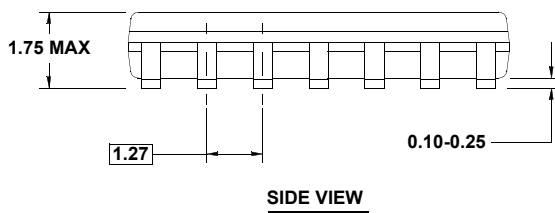
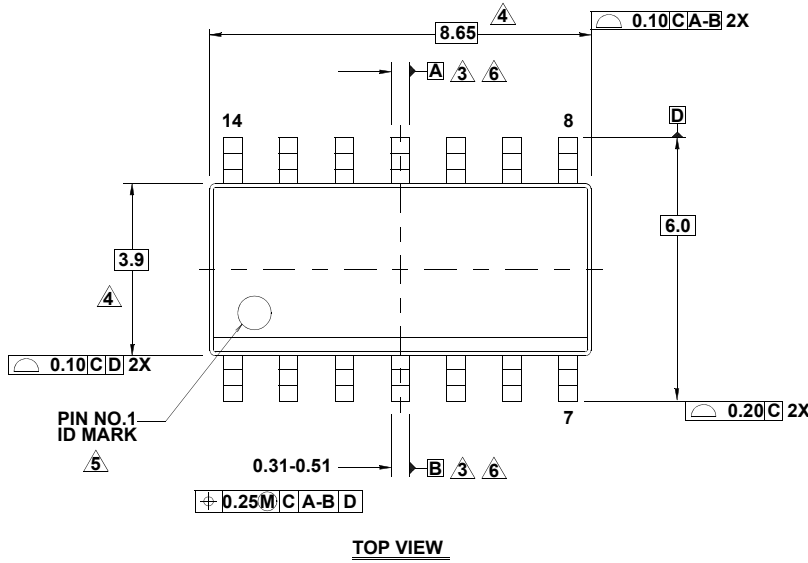

NOTES:

1. Dimensions are in millimeters.
Dimensions in () for Reference Only.
2. Dimensioning and tolerancing conform to AMSEY14.5m-1994.
3. Datums A and B to be determined at Datum H.
4. Dimension does not include interlead flash or protrusions.
Interlead flash or protrusions shall not exceed 0.25mm per side.
5. The pin #1 identifier may be either a mold or mark feature.
6. Does not include dambar protrusion. Allowable dambar protrusion shall be 0.10mm total in excess of lead width at maximum condition.
7. Reference to JEDEC MS-012-AB.

M16.15 (JEDEC MS-012-AC ISSUE C)

For the most recent package outline drawing, see [M16.15](#).

16 LEAD NARROW BODY SMALL OUTLINE PLASTIC PACKAGE
 Rev 2, 11/17



L16.3x3
16 LEAD QUAD FLAT NO-LEAD PLASTIC PACKAGE
 Rev 2, 4/07

For the most recent package outline drawing, see [L16.3x3](#).

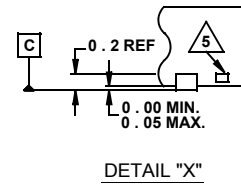
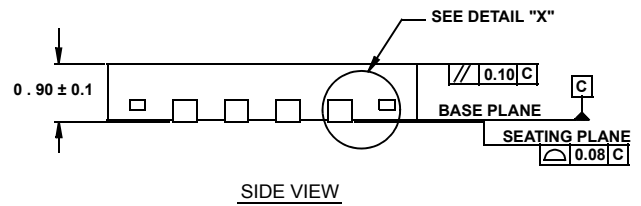

NOTES:

1. Dimensions are in millimeters.
Dimensions in () for Reference Only.
2. Dimensioning and tolerancing conform to AMSE Y14.5m-1994.
3. Unless otherwise specified, tolerance : Decimal ± 0.05
4. Dimension b applies to the metallized terminal and is measured between 0.15mm and 0.30mm from the terminal tip.
5. Tiebar shown (if present) is a non-functional feature.
6. The configuration of the pin #1 identifier is optional, but must be located within the zone indicated. The pin #1 identifier may be either a mold or mark feature.

IMPORTANT NOTICE AND DISCLAIMER

RENESAS ELECTRONICS CORPORATION AND ITS SUBSIDIARIES (“RENESAS”) PROVIDES TECHNICAL SPECIFICATIONS AND RELIABILITY DATA (INCLUDING DATASHEETS), DESIGN RESOURCES (INCLUDING REFERENCE DESIGNS), APPLICATION OR OTHER DESIGN ADVICE, WEB TOOLS, SAFETY INFORMATION, AND OTHER RESOURCES “AS IS” AND WITH ALL FAULTS, AND DISCLAIMS ALL WARRANTIES, EXPRESS OR IMPLIED, INCLUDING, WITHOUT LIMITATION, ANY IMPLIED WARRANTIES OF MERCHANTABILITY, FITNESS FOR A PARTICULAR PURPOSE, OR NON-INFRINGEMENT OF THIRD PARTY INTELLECTUAL PROPERTY RIGHTS.

These resources are intended for developers skilled in the art designing with Renesas products. You are solely responsible for (1) selecting the appropriate products for your application, (2) designing, validating, and testing your application, and (3) ensuring your application meets applicable standards, and any other safety, security, or other requirements. These resources are subject to change without notice. Renesas grants you permission to use these resources only for development of an application that uses Renesas products. Other reproduction or use of these resources is strictly prohibited. No license is granted to any other Renesas intellectual property or to any third party intellectual property. Renesas disclaims responsibility for, and you will fully indemnify Renesas and its representatives against, any claims, damages, costs, losses, or liabilities arising out of your use of these resources. Renesas' products are provided only subject to Renesas' Terms and Conditions of Sale or other applicable terms agreed to in writing. No use of any Renesas resources expands or otherwise alters any applicable warranties or warranty disclaimers for these products.

(Rev.1.0 Mar 2020)

Corporate Headquarters

TOYOSU FORESIA, 3-2-24 Toyosu,
Koto-ku, Tokyo 135-0061, Japan
www.renesas.com

Contact Information

For further information on a product, technology, the most up-to-date version of a document, or your nearest sales office, please visit:
www.renesas.com/contact/

Trademarks

Renesas and the Renesas logo are trademarks of Renesas Electronics Corporation. All trademarks and registered trademarks are the property of their respective owners.

Компания «Life Electronics» занимается поставками электронных компонентов импортного и отечественного производства от производителей и со складов крупных дистрибьюторов Европы, Америки и Азии.

С конца 2013 года компания активно расширяет линейку поставок компонентов по направлению коаксиальный кабель, кварцевые генераторы и конденсаторы (керамические, пленочные, электролитические), за счёт заключения дистрибьюторских договоров

Мы предлагаем:

- Конкуренеспособные цены и скидки постоянным клиентам.
- Специальные условия для постоянных клиентов.
- Подбор аналогов.
- Поставку компонентов в любых объемах, удовлетворяющих вашим потребностям.
- Приемлемые сроки поставки, возможна ускоренная поставка.
- Доставку товара в любую точку России и стран СНГ.
- Комплексную поставку.
- Работу по проектам и поставку образцов.
- Формирование склада под заказчика.
- Сертификаты соответствия на поставляемую продукцию (по желанию клиента).
- Тестирование поставляемой продукции.
- Поставку компонентов, требующих военную и космическую приемку.
- Входной контроль качества.
- Наличие сертификата ISO.

В составе нашей компании организован Конструкторский отдел, призванный помогать разработчикам, и инженерам.

Конструкторский отдел помогает осуществить:

- Регистрацию проекта у производителя компонентов.
- Техническую поддержку проекта.
- Защиту от снятия компонента с производства.
- Оценку стоимости проекта по компонентам.
- Изготовление тестовой платы монтаж и пусконаладочные работы.



Тел: +7 (812) 336 43 04 (многоканальный)
Email: org@lifeelectronics.ru