



# MCP6541/1R/1U/2/3/4

## Push-Pull Output Sub-Microamp Comparators

### Features:

- Low Quiescent Current: 600 nA/Comparator (typ.)
- Rail-to-Rail Input:  $V_{SS} - 0.3V$  to  $V_{DD} + 0.3V$
- CMOS/TTL-Compatible Output
- Propagation Delay: 4  $\mu s$  (typical, 100 mV Overdrive)
- Wide Supply Voltage Range: 1.6V to 5.5V
- Available in Single, Dual and Quad
- Single Available in SOT-23-5, SC-70-5 \* Packages
- Chip Select ( $\overline{CS}$ ) with MCP6543
- Low Switching Current
- Internal Hysteresis: 3.3 mV (typ.)
- Temperature Ranges:
  - Industrial:  $-40^{\circ}C$  to  $+85^{\circ}C$
  - Extended:  $-40^{\circ}C$  to  $+125^{\circ}C$

### Typical Applications:

- Laptop Computers
- Mobile Phones
- Metering Systems
- Hand-held Electronics
- RC Timers
- Alarm and Monitoring Circuits
- Windowed Comparators
- Multivibrators

### Related Devices:

- Open-Drain Output: MCP6546/7/8/9

### Package Types



### Description:

The Microchip Technology Inc. MCP6541/1R/1U/2/3/4 family of comparators is offered in single (MCP6541, MCP6541R, MCP6541U), single with Chip Select ( $\overline{CS}$ ) (MCP6543), dual (MCP6542) and quad (MCP6544) configurations. The outputs are push-pull (CMOS/TTL-compatible) and are capable of driving heavy DC or capacitive loads.

These comparators are optimized for low-power, single-supply operation with greater than rail-to-rail input operation. The push-pull output of the MCP6541/1R/1U/2/3/4 family supports rail-to-rail output swing and interfaces with TTL/CMOS logic. The internal input hysteresis eliminates output switching due to internal input noise voltage, reducing current draw. The output limits supply current surges and dynamic power consumption while switching. This product family operates with a single-supply voltage as low as 1.6V and draws less than 1  $\mu A$ /comparator of quiescent current.

The related MCP6546/7/8/9 family of comparators from Microchip has an open-drain output. Used with a pull-up resistor, these devices can be used as level-shifters for any desired voltage up to 10V and in wired-OR logic.

\* SC-70-5 E-Temp parts not available at this release of the data sheet.

MCP6541U SOT-23-5 is E-Temp only.

# MCP6541/1R/1U/2/3/4

---

NOTES:

## 1.0 ELECTRICAL CHARACTERISTICS

### Absolute Maximum Ratings †

$V_{DD} - V_{SS}$ .....	7.0V
Current at Analog Input Pin ( $V_{IN+}$ , $V_{IN-}$ ).....	$\pm 2$ mA
Analog Input ( $V_{IN}$ ) †† .....	$V_{SS} - 1.0V$ to $V_{DD} + 1.0V$
All other Inputs and Outputs.....	$V_{SS} - 0.3V$ to $V_{DD} + 0.3V$
Difference Input Voltage .....	$ V_{DD} - V_{SS} $
Output Short-Circuit Current .....	Continuous
Current at Input Pins .....	$\pm 2$ mA
Current at Output and Supply Pins .....	$\pm 30$ mA
Storage Temperature .....	$-65^{\circ}C$ to $+150^{\circ}C$
Maximum Junction Temperature ( $T_J$ ).....	$+150^{\circ}C$
ESD Protection on all Pins (HBM;MM) .....	4 kV; 400V

† **Notice:** Stresses above those listed under “Absolute Maximum Ratings” may cause permanent damage to the device. This is a stress rating only and functional operation of the device at those or any other conditions above those indicated in the operational listings of this specification is not implied. Exposure to maximum rating conditions for extended periods may affect device reliability.

†† See [Section 4.1.2 “Input Voltage and Current Limits”](#)

### DC CHARACTERISTICS

**Electrical Specifications:** Unless otherwise indicated,  $V_{DD} = +1.6V$  to  $+5.5V$ ,  $V_{SS} = GND$ ,  $T_A = +25^{\circ}C$ ,  $V_{IN+} = V_{DD}/2$ ,  $V_{IN-} = V_{SS}$ , and  $R_L = 100\text{ k}\Omega$  to  $V_{DD}/2$  (Refer to [Figure 1-3](#)).

Parameters	Sym	Min	Typ	Max	Units	Conditions
<b>Power Supply</b>						
Supply Voltage	$V_{DD}$	1.6	—	5.5	V	
Quiescent Current per comparator	$I_Q$	0.3	0.6	1.0	$\mu A$	$I_{OUT} = 0$
<b>Input</b>						
Input Voltage Range	$V_{CMR}$	$V_{SS}-0.3$	—	$V_{DD}+0.3$	V	
Common Mode Rejection Ratio	CMRR	55	70	—	dB	$V_{DD} = 5V$ , $V_{CM} = -0.3V$ to $5.3V$
Common Mode Rejection Ratio	CMRR	50	65	—	dB	$V_{DD} = 5V$ , $V_{CM} = 2.5V$ to $5.3V$
Common Mode Rejection Ratio	CMRR	55	70	—	dB	$V_{DD} = 5V$ , $V_{CM} = -0.3V$ to $2.5V$
Power Supply Rejection Ratio	PSRR	63	80	—	dB	$V_{CM} = V_{SS}$
Input Offset Voltage	$V_{OS}$	-7.0	$\pm 1.5$	+7.0	mV	$V_{CM} = V_{SS}$ ( <b>Note 1</b> )
Drift with Temperature	$\Delta V_{OS}/\Delta T_A$	—	$\pm 3$	—	$\mu V/^{\circ}C$	$T_A = -40^{\circ}C$ to $+125^{\circ}C$ , $V_{CM} = V_{SS}$
Input Hysteresis Voltage	$V_{HYST}$	1.5	3.3	6.5	mV	$V_{CM} = V_{SS}$ ( <b>Note 1</b> )
Linear Temp. Co. ( <b>Note 2</b> )	$TC_1$	—	6.7	—	$\mu V/^{\circ}C$	$T_A = -40^{\circ}C$ to $+125^{\circ}C$ , $V_{CM} = V_{SS}$
Quadratic Temp. Co. ( <b>Note 2</b> )	$TC_2$	—	-0.035	—	$\mu V/^{\circ}C^2$	$T_A = -40^{\circ}C$ to $+125^{\circ}C$ , $V_{CM} = V_{SS}$
Input Bias Current	$I_B$	—	1	—	pA	$V_{CM} = V_{SS}$
At Temperature (I-Temp parts)	$I_B$	—	25	100	pA	$T_A = +85^{\circ}C$ , $V_{CM} = V_{SS}$ ( <b>Note 3</b> )
At Temperature (E-Temp parts)	$I_B$	—	1200	5000	pA	$T_A = +125^{\circ}C$ , $V_{CM} = V_{SS}$ ( <b>Note 3</b> )
Input Offset Current	$I_{OS}$	—	$\pm 1$	—	pA	$V_{CM} = V_{SS}$
Common Mode Input Impedance	$Z_{CM}$	—	$10^{13}  4$	—	$\Omega  pF$	
Differential Input Impedance	$Z_{DIFF}$	—	$10^{13}  2$	—	$\Omega  pF$	

**Note 1:** The input offset voltage is the center (average) of the input-referred trip points. The input hysteresis is the difference between the input-referred trip points.

**2:**  $V_{HYST}$  at different temperatures is estimated using  $V_{HYST}(T_A) = V_{HYST} + (T_A - 25^{\circ}C) TC_1 + (T_A - 25^{\circ}C)^2 TC_2$ .

**3:** Input bias current at temperature is not tested for SC-70-5 package.

**4:** Limit the output current to Absolute Maximum Rating of 30 mA.

# MCP6541/1R/1U/2/3/4

## DC CHARACTERISTICS (CONTINUED)

**Electrical Specifications:** Unless otherwise indicated,  $V_{DD} = +1.6V$  to  $+5.5V$ ,  $V_{SS} = GND$ ,  $T_A = +25^\circ C$ ,  $V_{IN+} = V_{DD}/2$ ,  $V_{IN-} = V_{SS}$ , and  $R_L = 100\text{ k}\Omega$  to  $V_{DD}/2$  (Refer to [Figure 1-3](#)).

Parameters	Sym	Min	Typ	Max	Units	Conditions
<b>Push-Pull Output</b>						
High-Level Output Voltage	$V_{OH}$	$V_{DD}-0.2$	—	—	V	$I_{OUT} = -2\text{ mA}$ , $V_{DD} = 5V$
Low-Level Output Voltage	$V_{OL}$	—	—	$V_{SS}+0.2$	V	$I_{OUT} = 2\text{ mA}$ , $V_{DD} = 5V$
Short-Circuit Current	$I_{SC}$	—	-2.5, +1.5	—	mA	$V_{DD} = 1.6V$ ( <b>Note 4</b> )
	$I_{SC}$	—	$\pm 30$	—	mA	$V_{DD} = 5.5V$ ( <b>Note 4</b> )

- Note 1:** The input offset voltage is the center (average) of the input-referred trip points. The input hysteresis is the difference between the input-referred trip points.
- Note 2:**  $V_{HYST}$  at different temperatures is estimated using  $V_{HYST}(T_A) = V_{HYST} + (T_A - 25^\circ C) TC_1 + (T_A - 25^\circ C)^2 TC_2$ .
- Note 3:** Input bias current at temperature is not tested for SC-70-5 package.
- Note 4:** Limit the output current to Absolute Maximum Rating of 30 mA.

## AC CHARACTERISTICS

**Electrical Specifications:** Unless otherwise indicated,  $V_{DD} = +1.6V$  to  $+5.5V$ ,  $V_{SS} = GND$ ,  $T_A = +25^\circ C$ ,  $V_{IN+} = V_{DD}/2$ , Step = 200 mV, Overdrive = 100 mV, and  $C_L = 36\text{ pF}$  (Refer to [Figure 1-2](#) and [Figure 1-3](#)).

Parameters	Sym	Min	Typ	Max	Units	Conditions
Rise Time	$t_R$	—	0.85	—	$\mu s$	
Fall Time	$t_F$	—	0.85	—	$\mu s$	
Propagation Delay (High-to-Low)	$t_{PHL}$	—	4	8	$\mu s$	
Propagation Delay (Low-to-High)	$t_{PLH}$	—	4	8	$\mu s$	
Propagation Delay Skew	$t_{PDS}$	—	$\pm 0.2$	—	$\mu s$	( <b>Note 1</b> )
Maximum Toggle Frequency	$f_{MAX}$	—	160	—	kHz	$V_{DD} = 1.6V$
	$f_{MAX}$	—	120	—	kHz	$V_{DD} = 5.5V$
Input Noise Voltage	$E_{ni}$	—	200	—	$\mu V_{P-P}$	10 Hz to 100 kHz

- Note 1:** Propagation Delay Skew is defined as:  $t_{PDS} = t_{PLH} - t_{PHL}$ .

## MCP6543 CHIP SELECT ( $\overline{\text{CS}}$ ) CHARACTERISTICS

**Electrical Specifications:** Unless otherwise indicated,  $V_{\text{DD}} = +1.6\text{V}$  to  $+5.5\text{V}$ ,  $V_{\text{SS}} = \text{GND}$ ,  $T_{\text{A}} = +25^{\circ}\text{C}$ ,  $V_{\text{IN}+} = V_{\text{DD}}/2$ ,  $V_{\text{IN}-} = V_{\text{SS}}$ , and  $C_{\text{L}} = 36\text{ pF}$  (Refer to Figures 1-1 and 1-3).

Parameters	Sym	Min	Typ	Max	Units	Conditions
<b>CS Low Specifications</b>						
$\overline{\text{CS}}$ Logic Threshold, Low	$V_{\text{IL}}$	$V_{\text{SS}}$	—	$0.2 V_{\text{DD}}$	V	
$\overline{\text{CS}}$ Input Current, Low	$I_{\text{CSL}}$	—	5.0	—	pA	$\overline{\text{CS}} = V_{\text{SS}}$
<b>CS High Specifications</b>						
$\overline{\text{CS}}$ Logic Threshold, High	$V_{\text{IH}}$	$0.8 V_{\text{D}}$	—	$V_{\text{DD}}$	V	
$\overline{\text{CS}}$ Input Current, High	$I_{\text{CSH}}$	—	1	—	pA	$\overline{\text{CS}} = V_{\text{DD}}$
$\overline{\text{CS}}$ Input High, $V_{\text{DD}}$ Current	$I_{\text{DD}}$	—	18	—	pA	$\overline{\text{CS}} = V_{\text{DD}}$
$\overline{\text{CS}}$ Input High, GND Current	$I_{\text{SS}}$	—	-20	—	pA	$\overline{\text{CS}} = V_{\text{DD}}$
Comparator Output Leakage	$I_{\text{O(LEAK)}}$	—	1	—	pA	$V_{\text{OUT}} = V_{\text{DD}}$ , $\overline{\text{CS}} = V_{\text{DD}}$
<b>CS Dynamic Specifications</b>						
CS Low to Comparator Output Low Turn-on Time	$t_{\text{ON}}$	—	2	50	ms	$\overline{\text{CS}} = 0.2 V_{\text{DD}}$ to $V_{\text{OUT}} = V_{\text{DD}}/2$ , $V_{\text{IN}-} = V_{\text{DD}}$
$\overline{\text{CS}}$ High to Comparator Output High Z Turn-off Time	$t_{\text{OFF}}$	—	10	—	$\mu\text{s}$	$\overline{\text{CS}} = 0.8 V_{\text{DD}}$ to $V_{\text{OUT}} = V_{\text{DD}}/2$ , $V_{\text{IN}-} = V_{\text{DD}}$
$\overline{\text{CS}}$ Hysteresis	$V_{\text{CS\_HYS}_T}$	—	0.6	—	V	$V_{\text{DD}} = 5\text{V}$



**FIGURE 1-1:** Timing Diagram for the CS Pin on the MCP6543.



**FIGURE 1-2:** Propagation Delay Timing Diagram.

# MCP6541/1R/1U/2/3/4

## TEMPERATURE CHARACTERISTICS

Electrical Specifications: Unless otherwise indicated, $V_{DD} = +1.6V$ to $+5.5V$ and $V_{SS} = GND$ .						
Parameters	Sym	Min	Typ	Max	Units	Conditions
<b>Temperature Ranges</b>						
Specified Temperature Range	$T_A$	-40	—	+85	°C	
Operating Temperature Range	$T_A$	-40	—	+125	°C	Note
Storage Temperature Range	$T_A$	-65	—	+150	°C	
<b>Thermal Package Resistances</b>						
Thermal Resistance, 5L-SC-70	$\theta_{JA}$	—	331	—	°C/W	
Thermal Resistance, 5L-SOT-23	$\theta_{JA}$	—	220.7	—	°C/W	
Thermal Resistance, 8L-PDIP	$\theta_{JA}$	—	89.3	—	°C/W	
Thermal Resistance, 8L-SOIC	$\theta_{JA}$	—	149.5	—	°C/W	
Thermal Resistance, 8L-MSOP	$\theta_{JA}$	—	211	—	°C/W	
Thermal Resistance, 14L-PDIP	$\theta_{JA}$	—	70	—	°C/W	
Thermal Resistance, 14L-SOIC	$\theta_{JA}$	—	95.3	—	°C/W	
Thermal Resistance, 14L-TSSOP	$\theta_{JA}$	—	100	—	°C/W	

**Note:** The MCP6541/1R/1U/2/3/4 I-Temp parts operate over this extended temperature range, but with reduced performance. In any case, the Junction Temperature ( $T_J$ ) must not exceed the Absolute Maximum specification of  $+150^\circ\text{C}$ .

### 1.1 Test Circuit Configuration

This test circuit configuration is used to determine the AC and DC specifications.



**FIGURE 1-3:** AC and DC Test Circuit for the Push-Pull Output Comparators.

## 2.0 TYPICAL PERFORMANCE CURVES

**Note:** The graphs and tables provided following this note are a statistical summary based on a limited number of samples and are provided for informational purposes only. The performance characteristics listed herein are not tested or guaranteed. In some graphs or tables, the data presented may be outside the specified operating range (e.g., outside specified power supply range) and therefore outside the warranted range.

**Note:** Unless otherwise indicated,  $V_{DD} = +1.6V$  to  $+5.5V$ ,  $V_{SS} = GND$ ,  $T_A = +25^\circ C$ ,  $V_{IN+} = V_{DD}/2$ ,  $V_{IN-} = GND$ ,  $R_L = 100\text{ k}\Omega$  to  $V_{DD}/2$ , and  $C_L = 36\text{ pF}$ .



**FIGURE 2-1:** Input Offset Voltage at  $V_{CM} = V_{SS}$ .



**FIGURE 2-4:** Input Hysteresis Voltage at  $V_{CM} = V_{SS}$ .

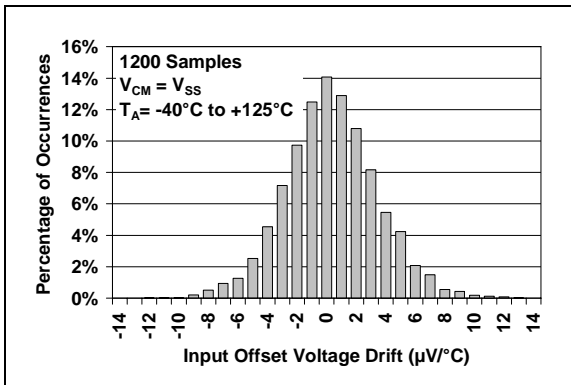

**FIGURE 2-2:** Input Offset Voltage Drift at  $V_{CM} = V_{SS}$ .

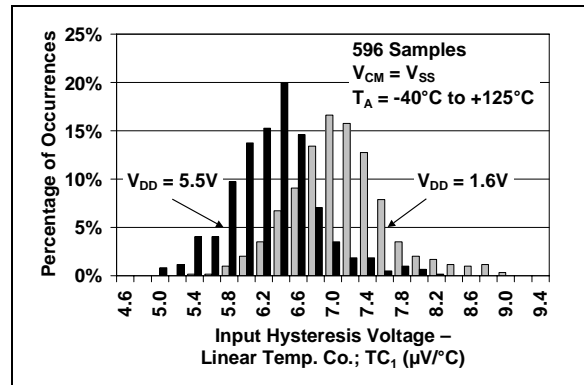

**FIGURE 2-5:** Input Hysteresis Voltage Linear Temp. Co. ( $TC_1$ ) at  $V_{CM} = V_{SS}$ .

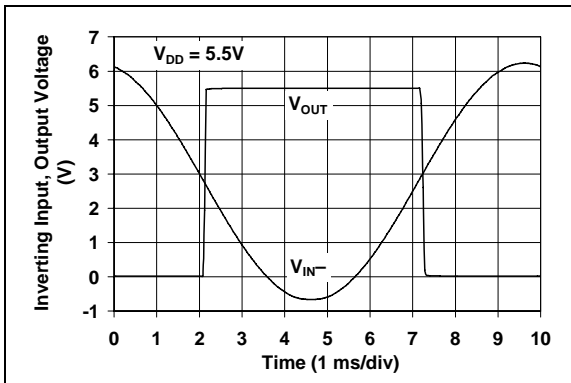

**FIGURE 2-3:** The MCP6541/1R/1U/2/3/4 Comparators Show No Phase Reversal.

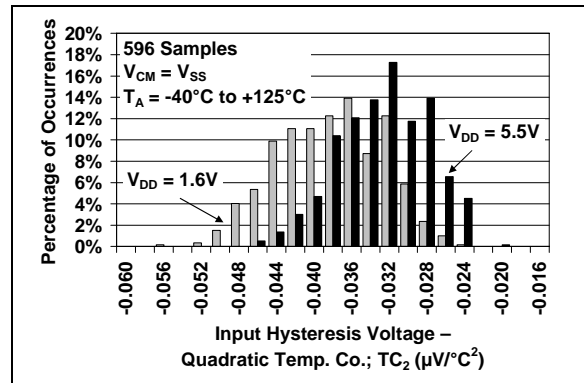

**FIGURE 2-6:** Input Hysteresis Voltage Quadratic Temp. Co. ( $TC_2$ ) at  $V_{CM} = V_{SS}$ .

# MCP6541/1R/1U/2/3/4

**Note:** Unless otherwise indicated,  $V_{DD} = +1.6V$  to  $+5.5V$ ,  $V_{SS} = GND$ ,  $T_A = +25^\circ C$ ,  $V_{IN+} = V_{DD}/2$ ,  $V_{IN-} = GND$ ,  $R_L = 100\text{ k}\Omega$  to  $V_{DD}/2$ , and  $C_L = 36\text{ pF}$ .



**FIGURE 2-7:** Input Offset Voltage vs. Ambient Temperature at  $V_{CM} = V_{SS}$ .

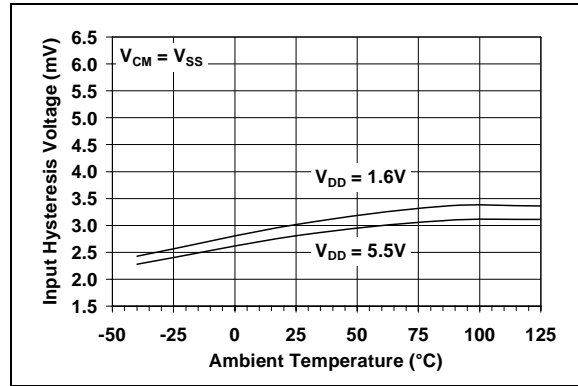

**FIGURE 2-10:** Input Hysteresis Voltage vs. Ambient Temperature at  $V_{CM} = V_{SS}$ .



**FIGURE 2-8:** Input Offset Voltage vs. Common Mode Input Voltage at  $V_{DD} = 1.6V$ .

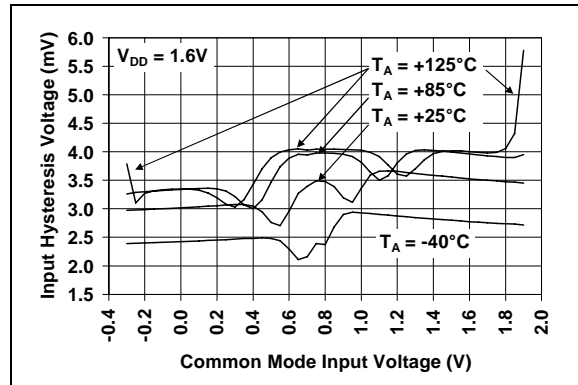

**FIGURE 2-11:** Input Hysteresis Voltage vs. Common Mode Input Voltage at  $V_{DD} = 1.6V$ .



**FIGURE 2-9:** Input Offset Voltage vs. Common Mode Input Voltage at  $V_{DD} = 5.5V$ .

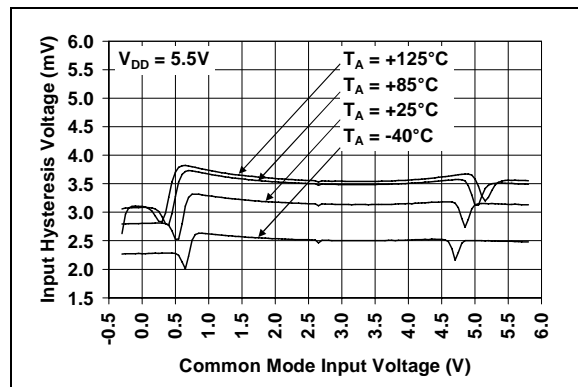

**FIGURE 2-12:** Input Hysteresis Voltage vs. Common Mode Input Voltage at  $V_{DD} = 5.5V$ .



# MCP6541/1R/1U/2/3/4

**Note:** Unless otherwise indicated,  $V_{DD} = +1.6V$  to  $+5.5V$ ,  $V_{SS} = GND$ ,  $T_A = +25^\circ C$ ,  $V_{IN+} = V_{DD}/2$ ,  $V_{IN-} = GND$ ,  $R_L = 100\text{ k}\Omega$  to  $V_{DD}/2$ , and  $C_L = 36\text{ pF}$ .



**FIGURE 2-13:** CMRR, PSRR vs. Ambient Temperature.



**FIGURE 2-16:** Input Bias Current, Input Offset Current vs. Common Mode Input Voltage.



**FIGURE 2-14:** Input Bias Current, Input Offset Current vs. Ambient Temperature.



**FIGURE 2-17:** Quiescent Current vs. Power Supply Voltage.



**FIGURE 2-15:** Quiescent Current vs. Common Mode Input Voltage at  $V_{DD} = 1.6V$ .



**FIGURE 2-18:** Quiescent Current vs. Common Mode Input Voltage at  $V_{DD} = 5.5V$ .

# MCP6541/1R/1U/2/3/4

**Note:** Unless otherwise indicated,  $V_{DD} = +1.6V$  to  $+5.5V$ ,  $V_{SS} = GND$ ,  $T_A = +25^\circ C$ ,  $V_{IN+} = V_{DD}/2$ ,  $V_{IN-} = GND$ ,  $R_L = 100\text{ k}\Omega$  to  $V_{DD}/2$ , and  $C_L = 36\text{ pF}$ .



**FIGURE 2-19:** Supply Current vs. Toggle Frequency.



**FIGURE 2-22:** Output Short Circuit Current Magnitude vs. Power Supply Voltage.



**FIGURE 2-20:** Output Voltage Headroom vs. Output Current at  $V_{DD} = 1.6V$ .



**FIGURE 2-23:** Output Voltage Headroom vs. Output Current at  $V_{DD} = 5.5V$ .

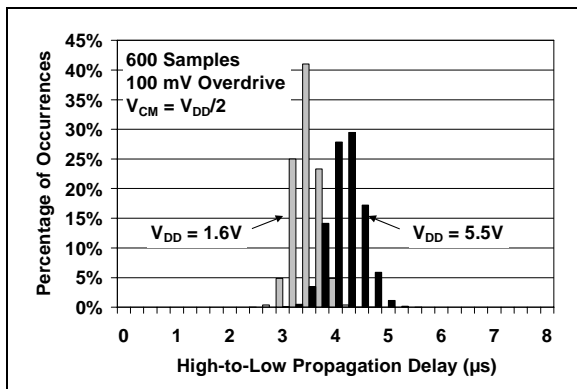

**FIGURE 2-21:** High-to-Low Propagation Delay.

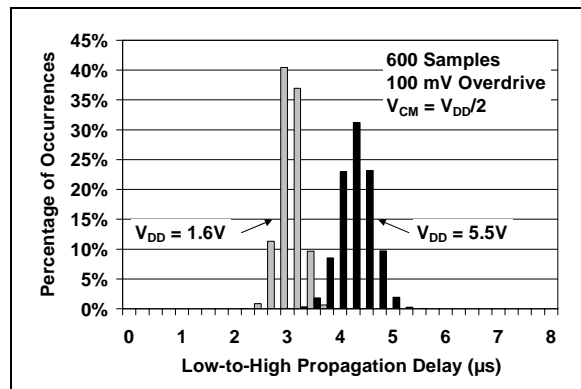

**FIGURE 2-24:** Low-to-High Propagation Delay.

# MCP6541/1R/1U/2/3/4

**Note:** Unless otherwise indicated,  $V_{DD} = +1.6V$  to  $+5.5V$ ,  $V_{SS} = GND$ ,  $T_A = +25^\circ C$ ,  $V_{IN+} = V_{DD}/2$ ,  $V_{IN-} = GND$ ,  $R_L = 100\ k\Omega$  to  $V_{DD}/2$ , and  $C_L = 36\ pF$ .



**FIGURE 2-25:** Propagation Delay Skew.



**FIGURE 2-28:** Propagation Delay vs. Ambient Temperature.



**FIGURE 2-26:** Propagation Delay vs. Power Supply Voltage.



**FIGURE 2-29:** Propagation Delay vs. Input Overdrive.



**FIGURE 2-27:** Propagation Delay vs. Common Mode Input Voltage at  $V_{DD} = 1.6V$ .



**FIGURE 2-30:** Propagation Delay vs. Common Mode Input Voltage at  $V_{DD} = 5.5V$ .

# MCP6541/1R/1U/2/3/4

**Note:** Unless otherwise indicated,  $V_{DD} = +1.6V$  to  $+5.5V$ ,  $V_{SS} = GND$ ,  $T_A = +25^\circ C$ ,  $V_{IN+} = V_{DD}/2$ ,  $V_{IN-} = GND$ ,  $R_L = 100\text{ k}\Omega$  to  $V_{DD}/2$ , and  $C_L = 36\text{ pF}$ .



**FIGURE 2-31:** Propagation Delay vs. Load Capacitance.

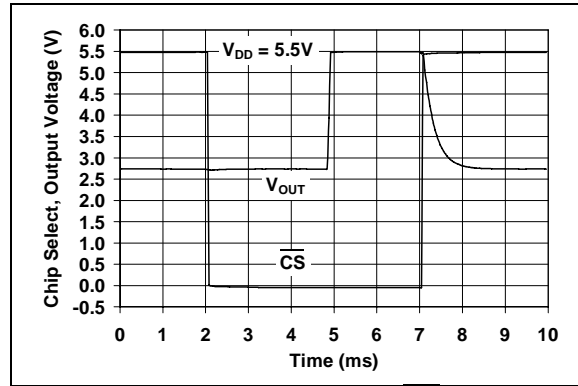

**FIGURE 2-34:** Chip Select (CS) Step Response (MCP6543 only).



**FIGURE 2-32:** Supply Current (shoot through current) vs. Chip Select (CS) Voltage at  $V_{DD} = 1.6V$  (MCP6543 only).

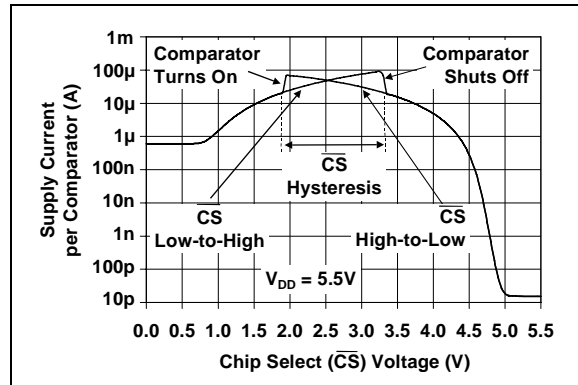

**FIGURE 2-35:** Supply Current (shoot through current) vs. Chip Select (CS) Voltage at  $V_{DD} = 5.5V$  (MCP6543 only).



**FIGURE 2-33:** Supply Current (charging current) vs. Chip Select (CS) pulse at  $V_{DD} = 1.6V$  (MCP6543 only).

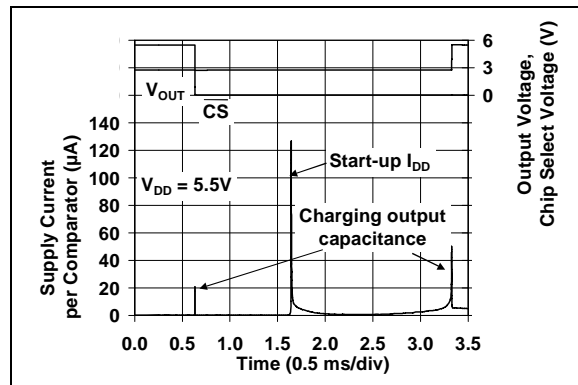

**FIGURE 2-36:** Supply Current (charging current) vs. Chip Select (CS) pulse at  $V_{DD} = 5.5V$  (MCP6543 only).

# MCP6541/1R/1U/2/3/4

**Note:** Unless otherwise indicated,  $V_{DD} = +1.6V$  to  $+5.5V$ ,  $V_{SS} = GND$ ,  $T_A = +25^\circ C$ ,  $V_{IN+} = V_{DD}/2$ ,  $V_{IN-} = GND$ ,  $R_L = 100\text{ k}\Omega$  to  $V_{DD}/2$ , and  $C_L = 36\text{ pF}$ .



**FIGURE 2-37:** *Input Bias Current vs. Input Voltage.*

# MCP6541/1R/1U/2/3/4

---

NOTES:

## 3.0 PIN DESCRIPTIONS

Descriptions of the pins are listed in [Table 3-1](#).

**TABLE 3-1: PIN FUNCTION TABLE**

MCP6541 PDIP, SOIC, MSOP	MCP6541 SOT-23-5, SC-70-5	MCP6541R	MCP6541U SOT-23-5 SC-70-5	MCP6542	MCP6543	MCP6544	Symbol	Description
6	1	1	4	1	6	1	OUT, OUTA	Digital Output (comparator A)
2	4	4	3	2	2	2	$V_{IN-}$ , $V_{INA-}$	Inverting Input (comparator A)
3	3	3	1	3	3	3	$V_{IN+}$ , $V_{INA+}$	Non-inverting Input (comparator A)
7	5	2	5	8	7	4	$V_{DD}$	Positive Power Supply
—	—	—	—	5	—	5	$V_{INB+}$	Non-inverting Input (comparator B)
—	—	—	—	6	—	6	$V_{INB-}$	Inverting Input (comparator B)
—	—	—	—	7	—	7	OUTB	Digital Output (comparator B)
—	—	—	—	—	—	8	OUTC	Digital Output (comparator C)
—	—	—	—	—	—	9	$V_{INC-}$	Inverting Input (comparator C)
—	—	—	—	—	—	10	$V_{INC+}$	Non-inverting Input (comparator C)
4	2	5	2	4	4	11	$V_{SS}$	Negative Power Supply
—	—	—	—	—	—	12	$V_{IND+}$	Non-inverting Input (comparator D)
—	—	—	—	—	—	13	$V_{IND-}$	Inverting Input (comparator D)
—	—	—	—	—	—	14	OUTD	Digital Output (comparator D)
—	—	—	—	—	8	—	$\overline{CS}$	Chip Select
1, 5, 8	—	—	—	—	1, 5	—	NC	No Internal Connection

### 3.1 Analog Inputs

The comparator non-inverting and inverting inputs are high-impedance CMOS inputs with low bias currents.

### 3.2 $\overline{CS}$ Digital Input

This is a CMOS, Schmitt-triggered input that places the part into a low-power mode of operation.

### 3.3 Digital Outputs

The comparator outputs are CMOS, push-pull digital outputs. They are designed to be compatible with CMOS and TTL logic and are capable of driving heavy DC or capacitive loads.

### 3.4 Power Supply ( $V_{SS}$ and $V_{DD}$ )

The positive power supply pin ( $V_{DD}$ ) is 1.6V to 5.5V higher than the negative power supply pin ( $V_{SS}$ ). For normal operation, the other pins are at voltages between  $V_{SS}$  and  $V_{DD}$ .

Typically, these parts are used in a single (positive) supply configuration. In this case,  $V_{SS}$  is connected to ground and  $V_{DD}$  is connected to the supply.  $V_{DD}$  will need a local bypass capacitor (typically 0.01  $\mu$ F to 0.1  $\mu$ F) within 2 mm of the  $V_{DD}$  pin. These can share a bulk capacitor with nearby analog parts (within 100 mm), but it is not required.

# MCP6541/1R/1U/2/3/4

---

NOTES:



## 4.0 APPLICATIONS INFORMATION

The MCP6541/1R/1U/2/3/4 family of push-pull output comparators are fabricated on Microchip's state-of-the-art CMOS process. They are suitable for a wide range of applications requiring very low-power consumption.

### 4.1 Comparator Inputs

#### 4.1.1 PHASE REVERSAL

The MCP6541/1R/1U/2/3/4 comparator family uses CMOS transistors at the input. They are designed to prevent phase inversion when the input pins exceed the supply voltages. Figure 2-3 shows an input voltage exceeding both supplies with no resulting phase inversion.

#### 4.1.2 INPUT VOLTAGE AND CURRENT LIMITS

The ESD protection on the inputs can be depicted as shown in Figure 4-1. This structure was chosen to protect the input transistors, and to minimize input bias current (IB). The input ESD diodes clamp the inputs when they try to go more than one diode drop below  $V_{SS}$ . They also clamp any voltages that go too far above  $V_{DD}$ ; their breakdown voltage is high enough to allow normal operation, and low enough to bypass ESD events within the specified limits.



**FIGURE 4-1:** Simplified Analog Input ESD Structures.

In order to prevent damage and/or improper operation of these amplifiers, the circuits they are in must limit the currents (and voltages) at the  $V_{IN+}$  and  $V_{IN-}$  pins (see [Absolute Maximum Ratings](#) † at the beginning of [Section 1.0 “Electrical Characteristics”](#)). Figure 4-3 shows the recommended approach to protecting these inputs. The internal ESD diodes prevent the input pins ( $V_{IN+}$  and  $V_{IN-}$ ) from going too far below ground, and the resistors  $R_1$  and  $R_2$ , limit the possible current drawn out of the input pin. Diodes  $D_1$  and  $D_2$  prevent the input pin ( $V_{IN+}$  and  $V_{IN-}$ ) from going too far above  $V_{DD}$ . When implemented as shown, resistors  $R_1$  and  $R_2$  also limit the current through  $D_1$  and  $D_2$ .



**FIGURE 4-2:** Protecting the Analog Inputs.

It is also possible to connect the diodes to the left of the resistors  $R_1$  and  $R_2$ . In this case, the currents through the diodes  $D_1$  and  $D_2$  need to be limited by some other mechanism. The resistor then serves as in-rush current limiter; the DC current into the input pins ( $V_{IN+}$  and  $V_{IN-}$ ) should be very small.

A significant amount of current can flow out of the inputs when the common mode voltage ( $V_{CM}$ ) is below ground ( $V_{SS}$ ); see [Figure 2-37](#). Applications that are high-impedance may need to limit the usable voltage range.

#### 4.1.3 NORMAL OPERATION

The input stage of this family of devices uses two differential input stages in parallel: one operates at low input voltages and the other at high input voltages. With this topology, the input voltage is 0.3V above  $V_{DD}$  and 0.3V below  $V_{SS}$ . Therefore, the input offset voltage is measured at both  $V_{SS} - 0.3V$  and  $V_{DD} + 0.3V$  to ensure proper operation.

The MCP6541/1R/1U/2/3/4 family has internally-set hysteresis that is small enough to maintain input offset accuracy (<7 mV) and large enough to eliminate output chattering caused by the comparator's own input noise voltage (200  $\mu V_{p-p}$ ). [Figure 4-3](#) depicts this behavior.

# MCP6541/1R/1U/2/3/4



**FIGURE 4-3:** The MCP6541/1R/1U/2/3/4 comparators' internal hysteresis eliminates output chatter caused by input noise voltage.

## 4.2 Push-Pull Output

The push-pull output is designed to be compatible with CMOS and TTL logic, while the output transistors are configured to give rail-to-rail output performance. They are driven with circuitry that minimizes any switching current (shoot-through current from supply-to-supply) when the output is transitioned from high-to-low, or from low-to-high (see Figures 2-15, 2-18, and 2-32 — 2-36 for more information).

## 4.3 MCP6543 Chip Select ( $\overline{CS}$ )

The MCP6543 is a single comparator with Chip Select ( $\overline{CS}$ ). When  $\overline{CS}$  is pulled high, the total current consumption drops to 20 pA (typ.); 1 pA (typ.) flows through the  $\overline{CS}$  pin, 1 pA (typ.) flows through the output pin and 18 pA (typ.) flows through the  $V_{DD}$  pin, as shown in Figure 1-1. When this happens, the comparator output is put into a high-impedance state. By pulling  $\overline{CS}$  low, the comparator is enabled. If the  $\overline{CS}$  pin is left floating, the comparator will not operate properly. Figure 1-1 shows the output voltage and supply current response to a  $\overline{CS}$  pulse.

The internal  $\overline{CS}$  circuitry is designed to minimize glitches when cycling the  $\overline{CS}$  pin. This helps conserve power, which is especially important in battery-powered applications.

## 4.4 Externally Set Hysteresis

Greater flexibility in selecting hysteresis (or input trip points) is achieved by using external resistors.

Input offset voltage ( $V_{OS}$ ) is the center (average) of the (input-referred) low-high and high-low trip points. Input hysteresis voltage ( $V_{HYST}$ ) is the difference between the same trip points. Hysteresis reduces output chattering when one input is slowly moving past the other and thus reduces dynamic supply current. It also helps in systems where it is best not to cycle between states too frequently (e.g., air conditioner thermostatic control).

### 4.4.1 NON-INVERTING CIRCUIT

Figure 4-4 shows a non-inverting circuit for single-supply applications using just two resistors. The resulting hysteresis diagram is shown in Figure 4-5.



**FIGURE 4-4:** Non-inverting Circuit with Hysteresis for Single-supply.



**FIGURE 4-5:** Hysteresis Diagram for the Non-Inverting Circuit.

The trip points for Figures 4-4 and 4-5 are:

### EQUATION 4-1:

$$V_{TLH} = V_{REF} \left( 1 + \frac{R_1}{R_F} \right) - V_{OL} \left( \frac{R_1}{R_F} \right)$$

$$V_{THL} = V_{REF} \left( 1 + \frac{R_1}{R_F} \right) - V_{OH} \left( \frac{R_1}{R_F} \right)$$

$V_{TLH}$  = trip voltage from low-to-high

$V_{THL}$  = trip voltage from high-to-low

## 4.4.2 INVERTING CIRCUIT

Figure 4-6 shows an inverting circuit for single-supply using three resistors. The resulting hysteresis diagram is shown in Figure 4-7.



**FIGURE 4-6:** Inverting Circuit With Hysteresis.



**FIGURE 4-7:** Hysteresis Diagram for the Inverting Circuit.

In order to determine the trip voltages ( $V_{THL}$  and  $V_{TLH}$ ) for the circuit shown in Figure 4-6,  $R_2$  and  $R_3$  can be simplified to the Thevenin equivalent circuit with respect to  $V_{DD}$ , as shown in Figure 4-8.



**FIGURE 4-8:** Thevenin Equivalent Circuit.

Where:

$$R_{23} = \frac{R_2 R_3}{R_2 + R_3}$$

$$V_{23} = \frac{R_3}{R_2 + R_3} \times V_{DD}$$

Using this simplified circuit, the trip voltage can be calculated using the following equation:

### EQUATION 4-2:

$$V_{THL} = V_{OH} \left( \frac{R_{23}}{R_{23} + R_F} \right) + V_{23} \left( \frac{R_F}{R_{23} + R_F} \right)$$

$$V_{TLH} = V_{OL} \left( \frac{R_{23}}{R_{23} + R_F} \right) + V_{23} \left( \frac{R_F}{R_{23} + R_F} \right)$$

$V_{TLH}$  = trip voltage from low-to-high

$V_{THL}$  = trip voltage from high-to-low

Figure 2-20 and Figure 2-23 can be used to determine typical values for  $V_{OH}$  and  $V_{OL}$ .

## 4.5 Bypass Capacitors

With this family of comparators, the power supply pin ( $V_{DD}$  for single supply) should have a local bypass capacitor (i.e., 0.01  $\mu\text{F}$  to 0.1  $\mu\text{F}$ ) within 2 mm for good edge rate performance.

## 4.6 Capacitive Loads

Reasonable capacitive loads (e.g., logic gates) have little impact on propagation delay (see Figure 2-31). The supply current increases with increasing toggle frequency (Figure 2-19), especially with higher capacitive loads.

## 4.7 Battery Life

In order to maximize battery life in portable applications, use large resistors and small capacitive loads. Avoid toggling the output more than necessary. Do not use Chip Select (CS) frequently to conserve start-up power. Capacitive loads will draw additional power at start-up.

## 4.8 PCB Surface Leakage

In applications where low input bias current is critical, PCB (Printed Circuit Board) surface leakage effects need to be considered. Surface leakage is caused by humidity, dust or other contamination on the board. Under low humidity conditions, a typical resistance between nearby traces is  $10^{12} \Omega$ . A 5V difference would cause 5 pA of current to flow. This is greater than the MCP6541/1R/1U/2/3/4 family's bias current at 25°C (1 pA, typ.).

# MCP6541/1R/1U/2/3/4

The easiest way to reduce surface leakage is to use a guard ring around sensitive pins (or traces). The guard ring is biased at the same voltage as the sensitive pin. An example of this type of layout is shown in Figure 4-9.



**FIGURE 4-9:** Example Guard Ring Layout for Inverting Circuit.

1. Inverting Configuration (Figures 4-6 and 4-9):
  - a. Connect the guard ring to the non-inverting input pin ( $V_{IN+}$ ). This biases the guard ring to the same reference voltage as the comparator (e.g.,  $V_{DD}/2$  or ground).
  - b. Connect the inverting pin ( $V_{IN-}$ ) to the input pad without touching the guard ring.
2. Non-inverting Configuration (Figure 4-4):
  - a. Connect the non-inverting pin ( $V_{IN+}$ ) to the input pad without touching the guard ring.
  - b. Connect the guard ring to the inverting input pin ( $V_{IN-}$ ).

## 4.9 Unused Comparators

An unused amplifier in a quad package (MCP6544) should be configured as shown in Figure 4-10. This circuit prevents the output from toggling and causing crosstalk. It uses the minimum number of components and draws minimal current (see Figure 2-15 and Figure 2-18).



**FIGURE 4-10:** Unused Comparators.

## 4.10 Typical Applications

### 4.10.1 PRECISE COMPARATOR

Some applications require higher DC precision. An easy way to solve this problem is to use an amplifier (such as the MCP6041) to gain-up the input signal before it reaches the comparator. Figure 4-11 shows an example of this approach.



**FIGURE 4-11:** Precise Inverting Comparator.

### 4.10.2 WINDOWED COMPARATOR

Figure 4-12 shows one approach to designing a windowed comparator. The AND gate produces a logic '1' when the input voltage is between  $V_{RB}$  and  $V_{RT}$  (where  $V_{RT} > V_{RB}$ ).



**FIGURE 4-12:** Windowed Comparator.

### 4.10.3 ASTABLE MULTIVIBRATOR

A simple astable multivibrator design is shown in Figure 4-13.  $V_{REF}$  needs to be between the power supplies ( $V_{SS} = GND$  and  $V_{DD}$ ) to achieve oscillation. The output duty cycle changes with  $V_{REF}$ .



**FIGURE 4-13:** Astable Multivibrator.

# MCP6541/1R/1U/2/3/4

## 5.0 PACKAGING INFORMATION

### 5.1 Package Marking Information

#### 5-Lead SC-70 (MCP6541, MCP6541U)



Device	I-Temp Code	E-Temp Code
MCP6541T-I/LT	ABNN	Note 2
MCP6541UT-I/LT	BANN	Note 2

**Note 1:** I-Temp parts prior to March 2005 are marked "BAN"

**2:** SC-70-5 E-Temp parts not available at this release of this data sheet.

Example:



#### 5-Lead SOT-23 (MCP6541, MCP6541R, MCP6541U)



Device	I-Temp Code	E-Temp Code
MCP6541	ABNN	GTNN
MCP6541R	AGNN	GUNN
MCP6541U	—	ATNN

**Note:** Applies to 5-Lead SOT-23

Example:



#### 8-Lead PDIP (300 mil) (MCP6541, MCP6542, MCP6543, MCP6544)

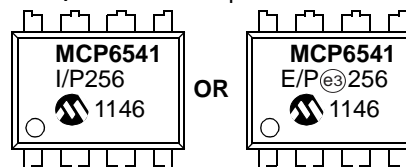
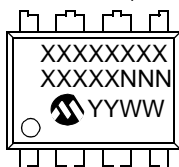

Example:

#### 8-Lead SOIC (150 mil) (MCP6541, MCP6542, MCP6543, MCP6544)

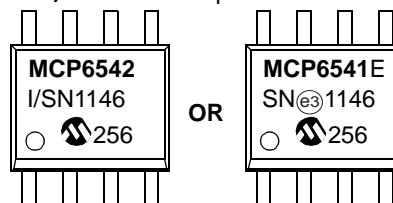
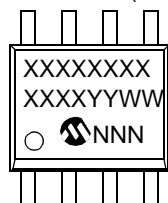

Example:

#### 8-Lead MSOP (MCP6541, MCP6542, MCP6543)

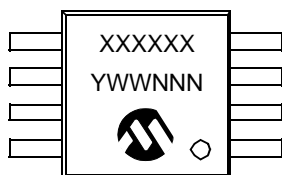

Example:

<b>Legend:</b>	XX...X	Customer-specific information
	Y	Year code (last digit of calendar year)
	YY	Year code (last 2 digits of calendar year)
	WW	Week code (week of January 1 is week '01')
	NNN	Alphanumeric traceability code
	(e3)	Pb-free JEDEC designator for Matte Tin (Sn)
	*	This package is Pb-free. The Pb-free JEDEC designator (e3) can be found on the outer packaging for this package.

**Note:** In the event the full Microchip part number cannot be marked on one line, it will be carried over to the next line, thus limiting the number of available characters for customer-specific information.

# MCP6541/1R/1U/2/3/4

## Package Marking Information (Continued)

14-Lead PDIP (300 mil) (MCP6544)



Example:

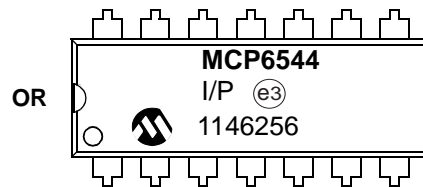
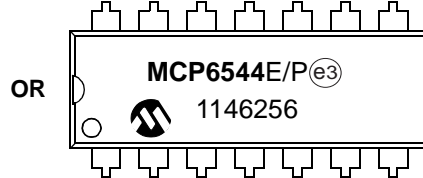
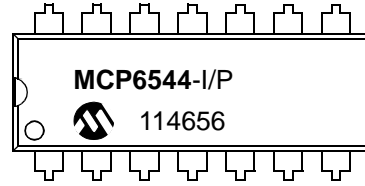

14-Lead SOIC (150 mil) (MCP6544)

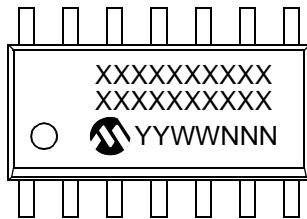

Example:

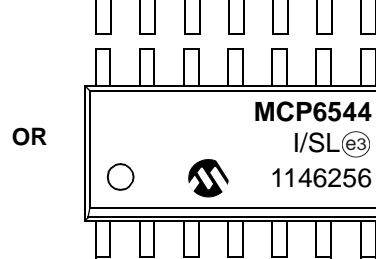
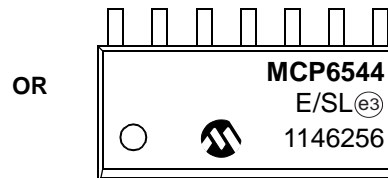
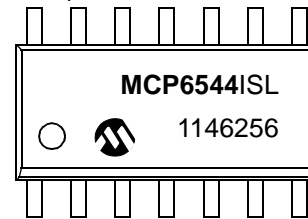

14-Lead TSSOP (MCP6544)



Example:



# MCP6541/1R/1U/2/3/4

## 5-Lead Plastic Small Outline Transistor (LT) [SC70]

**Note:** For the most current package drawings, please see the Microchip Packaging Specification located at <http://www.microchip.com/packaging>

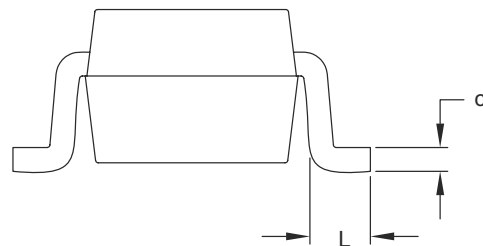
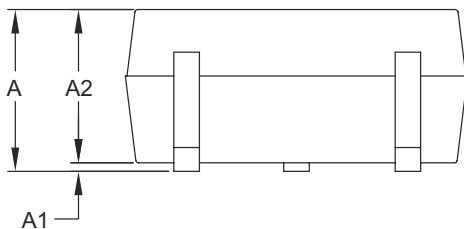
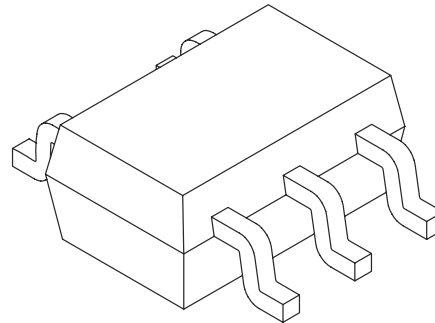
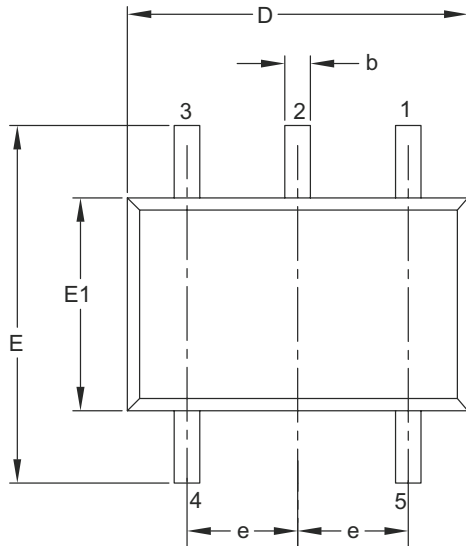

Dimension Limits	Units	MILLIMETERS		
		MIN	NOM	MAX
Number of Pins	N	5		
Pitch	e	0.65 BSC		
Overall Height	A	0.80	–	1.10
Molded Package Thickness	A2	0.80	–	1.00
Standoff	A1	0.00	–	0.10
Overall Width	E	1.80	2.10	2.40
Molded Package Width	E1	1.15	1.25	1.35
Overall Length	D	1.80	2.00	2.25
Foot Length	L	0.10	0.20	0.46
Lead Thickness	c	0.08	–	0.26
Lead Width	b	0.15	–	0.40

**Notes:**

- Dimensions D and E1 do not include mold flash or protrusions. Mold flash or protrusions shall not exceed 0.127 mm per side.
- Dimensioning and tolerancing per ASME Y14.5M.  
BSC: Basic Dimension. Theoretically exact value shown without tolerances.

Microchip Technology Drawing C04-061B

# MCP6541/1R/1U/2/3/4

## 5-Lead Plastic Small Outline Transistor (LT) [SC70]

**Note:** For the most current package drawings, please see the Microchip Packaging Specification located at <http://www.microchip.com/packaging>



RECOMMENDED LAND PATTERN

Dimension Limits	Units	MILLIMETERS		
		MIN	NOM	MAX
Contact Pitch	E	0.65 BSC		
Contact Pad Spacing	C	2.20		
Contact Pad Width	X			0.45
Contact Pad Length	Y			0.95
Distance Between Pads	G	1.25		
Distance Between Pads	Gx	0.20		

Notes:

1. Dimensioning and tolerancing per ASME Y14.5M

BSC: Basic Dimension. Theoretically exact value shown without tolerances.

Microchip Technology Drawing No. C04-2061A



# MCP6541/1R/1U/2/3/4

## 5-Lead Plastic Small Outline Transistor (OT) [SOT-23]

**Note:** For the most current package drawings, please see the Microchip Packaging Specification located at <http://www.microchip.com/packaging>



Dimension Limits	Units	MILLIMETERS		
		MIN	NOM	MAX
Number of Pins	N	5		
Lead Pitch	e	0.95 BSC		
Outside Lead Pitch	e1	1.90 BSC		
Overall Height	A	0.90	–	1.45
Molded Package Thickness	A2	0.89	–	1.30
Standoff	A1	0.00	–	0.15
Overall Width	E	2.20	–	3.20
Molded Package Width	E1	1.30	–	1.80
Overall Length	D	2.70	–	3.10
Foot Length	L	0.10	–	0.60
Footprint	L1	0.35	–	0.80
Foot Angle	$\phi$	0°	–	30°
Lead Thickness	c	0.08	–	0.26
Lead Width	b	0.20	–	0.51

**Notes:**

- Dimensions D and E1 do not include mold flash or protrusions. Mold flash or protrusions shall not exceed 0.127 mm per side.
- Dimensioning and tolerancing per ASME Y14.5M.

BSC: Basic Dimension. Theoretically exact value shown without tolerances.

Microchip Technology Drawing C04-091B

# MCP6541/1R/1U/2/3/4

## 5-Lead Plastic Small Outline Transistor (OT) [SOT-23]

**Note:** For the most current package drawings, please see the Microchip Packaging Specification located at <http://www.microchip.com/packaging>

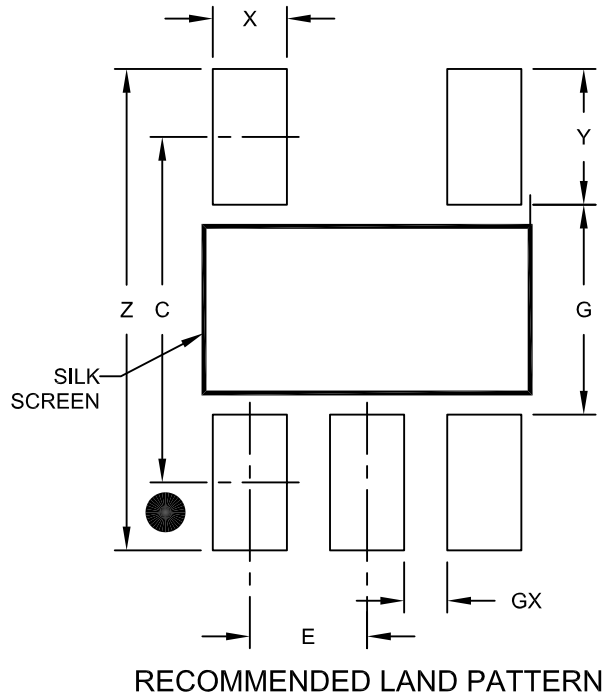

Dimension Limits	Units	MILLIMETERS		
		MIN	NOM	MAX
Contact Pitch	E	0.95 BSC		
Contact Pad Spacing	C		2.80	
Contact Pad Width (X5)	X			0.60
Contact Pad Length (X5)	Y			1.10
Distance Between Pads	G	1.70		
Distance Between Pads	GX	0.35		
Overall Width	Z			3.90

**Notes:**

1. Dimensioning and tolerancing per ASME Y14.5M

BSC: Basic Dimension. Theoretically exact value shown without tolerances.

Microchip Technology Drawing No. C04-2091A

# MCP6541/1R/1U/2/3/4

## 8-Lead Plastic Dual In-Line (P) – 300 mil Body [PDIP]

**Note:** For the most current package drawings, please see the Microchip Packaging Specification located at <http://www.microchip.com/packaging>



Dimension Limits	Units	INCHES		
		MIN	NOM	MAX
Number of Pins	N	8		
Pitch	e	.100 BSC		
Top to Seating Plane	A	–	–	.210
Molded Package Thickness	A2	.115	.130	.195
Base to Seating Plane	A1	.015	–	–
Shoulder to Shoulder Width	E	.290	.310	.325
Molded Package Width	E1	.240	.250	.280
Overall Length	D	.348	.365	.400
Tip to Seating Plane	L	.115	.130	.150
Lead Thickness	c	.008	.010	.015
Upper Lead Width	b1	.040	.060	.070
Lower Lead Width	b	.014	.018	.022
Overall Row Spacing §	eB	–	–	.430

**Notes:**

- Pin 1 visual index feature may vary, but must be located with the hatched area.
- § Significant Characteristic.
- Dimensions D and E1 do not include mold flash or protrusions. Mold flash or protrusions shall not exceed .010" per side.
- Dimensioning and tolerancing per ASME Y14.5M.

BSC: Basic Dimension. Theoretically exact value shown without tolerances.

Microchip Technology Drawing C04-018B

# MCP6541/1R/1U/2/3/4

## 8-Lead Plastic Small Outline (SN) - Narrow, 3.90 mm Body [SOIC]

**Note:** For the most current package drawings, please see the Microchip Packaging Specification located at <http://www.microchip.com/packaging>



Microchip Technology Drawing No. C04-057C Sheet 1 of 2

# MCP6541/1R/1U/2/3/4

## 8-Lead Plastic Small Outline (SN) - Narrow, 3.90 mm Body [SOIC]

**Note:** For the most current package drawings, please see the Microchip Packaging Specification located at <http://www.microchip.com/packaging>



Dimension Limits	Units	MILLIMETERS		
		MIN	NOM	MAX
Number of Pins	N	8		
Pitch	e	1.27 BSC		
Overall Height	A	-	-	1.75
Molded Package Thickness	A2	1.25	-	-
Standoff §	A1	0.10	-	0.25
Overall Width	E	6.00 BSC		
Molded Package Width	E1	3.90 BSC		
Overall Length	D	4.90 BSC		
Chamfer (Optional)	h	0.25	-	0.50
Foot Length	L	0.40	-	1.27
Footprint	L1	1.04 REF		
Foot Angle	φ	0°	-	8°
Lead Thickness	c	0.17	-	0.25
Lead Width	b	0.31	-	0.51
Mold Draft Angle Top	α	5°	-	15°
Mold Draft Angle Bottom	β	5°	-	15°

### Notes:

1. Pin 1 visual index feature may vary, but must be located within the hatched area.
2. § Significant Characteristic
3. Dimensions D and E1 do not include mold flash or protrusions. Mold flash or protrusions shall not exceed 0.15mm per side.
4. Dimensioning and tolerancing per ASME Y14.5M

BSC: Basic Dimension. Theoretically exact value shown without tolerances.

REF: Reference Dimension, usually without tolerance, for information purposes only.

Microchip Technology Drawing No. C04-057C Sheet 2 of 2

# MCP6541/1R/1U/2/3/4

## 8-Lead Plastic Small Outline (SN) – Narrow, 3.90 mm Body [SOIC]

**Note:** For the most current package drawings, please see the Microchip Packaging Specification located at <http://www.microchip.com/packaging>



RECOMMENDED LAND PATTERN

		Units	MILLIMETERS		
Dimension Limits			MIN	NOM	MAX
Contact Pitch	E		1.27 BSC		
Contact Pad Spacing	C			5.40	
Contact Pad Width (X8)	X1				0.60
Contact Pad Length (X8)	Y1				1.55

Notes:

1. Dimensioning and tolerancing per ASME Y14.5M

BSC: Basic Dimension. Theoretically exact value shown without tolerances.

Microchip Technology Drawing No. C04-2057A

# MCP6541/1R/1U/2/3/4

## 8-Lead Plastic Micro Small Outline Package (MS) [MSOP]

**Note:** For the most current package drawings, please see the Microchip Packaging Specification located at <http://www.microchip.com/packaging>

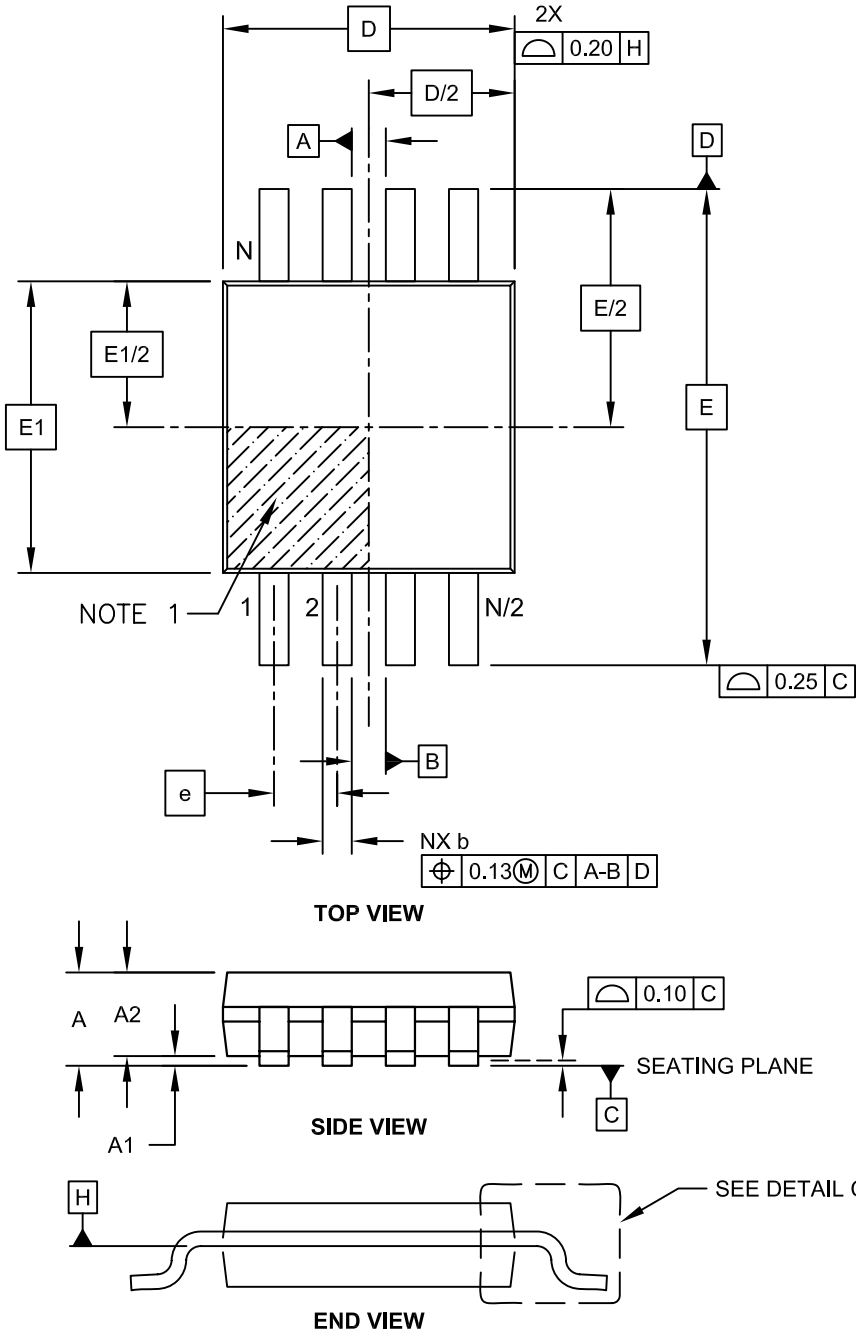

Microchip Technology Drawing C04-111C Sheet 1 of 2

# MCP6541/1R/1U/2/3/4

## 8-Lead Plastic Micro Small Outline Package (MS) [MSOP]

**Note:** For the most current package drawings, please see the Microchip Packaging Specification located at <http://www.microchip.com/packaging>



Dimension Limits	Units	MILLIMETERS		
		MIN	NOM	MAX
Number of Pins	N		8	
Pitch	e	0.65 BSC		
Overall Height	A	-	-	1.10
Molded Package Thickness	A2	0.75	0.85	0.95
Standoff	A1	0.00	-	0.15
Overall Width	E	4.90 BSC		
Molded Package Width	E1	3.00 BSC		
Overall Length	D	3.00 BSC		
Foot Length	L	0.40	0.60	0.80
Footprint	L1	0.95 REF		
Foot Angle	φ	0°	-	8°
Lead Thickness	c	0.08	-	0.23
Lead Width	b	0.22	-	0.40

**Notes:**

- Pin 1 visual index feature may vary, but must be located within the hatched area.
- Dimensions D and E1 do not include mold flash or protrusions. Mold flash or protrusions shall not exceed 0.15mm per side.
- Dimensioning and tolerancing per ASME Y14.5M.  
 BSC: Basic Dimension. Theoretically exact value shown without tolerances.  
 REF: Reference Dimension, usually without tolerance, for information purposes only.

Microchip Technology Drawing C04-111C Sheet 2 of 2



# MCP6541/1R/1U/2/3/4

## 8-Lead Plastic Micro Small Outline Package (MS) [MSOP]

**Note:** For the most current package drawings, please see the Microchip Packaging Specification located at <http://www.microchip.com/packaging>



RECOMMENDED LAND PATTERN

Dimension Limits	Units	MILLIMETERS		
		MIN	NOM	MAX
Contact Pitch	E	0.65 BSC		
Contact Pad Spacing	C		4.40	
Overall Width	Z			5.85
Contact Pad Width (X8)	X1			0.45
Contact Pad Length (X8)	Y1			1.45
Distance Between Pads	G1	2.95		
Distance Between Pads	GX	0.20		

**Notes:**

1. Dimensioning and tolerancing per ASME Y14.5M

BSC: Basic Dimension. Theoretically exact value shown without tolerances.

Microchip Technology Drawing No. C04-2111A

# MCP6541/1R/1U/2/3/4

## 14-Lead Plastic Dual In-Line (P) – 300 mil Body [PDIP]

**Note:** For the most current package drawings, please see the Microchip Packaging Specification located at <http://www.microchip.com/packaging>



Dimension Limits	Units	INCHES		
		MIN	NOM	MAX
Number of Pins	N	14		
Pitch	e	.100 BSC		
Top to Seating Plane	A	–	–	.210
Molded Package Thickness	A2	.115	.130	.195
Base to Seating Plane	A1	.015	–	–
Shoulder to Shoulder Width	E	.290	.310	.325
Molded Package Width	E1	.240	.250	.280
Overall Length	D	.735	.750	.775
Tip to Seating Plane	L	.115	.130	.150
Lead Thickness	c	.008	.010	.015
Upper Lead Width	b1	.045	.060	.070
Lower Lead Width	b	.014	.018	.022
Overall Row Spacing §	eB	–	–	.430

**Notes:**

- Pin 1 visual index feature may vary, but must be located with the hatched area.
- § Significant Characteristic.
- Dimensions D and E1 do not include mold flash or protrusions. Mold flash or protrusions shall not exceed .010" per side.
- Dimensioning and tolerancing per ASME Y14.5M.

BSC: Basic Dimension. Theoretically exact value shown without tolerances.

Microchip Technology Drawing C04-005B

# MCP6541/1R/1U/2/3/4

## 14-Lead Plastic Small Outline (SL) - Narrow, 3.90 mm Body [SOIC]

**Note:** For the most current package drawings, please see the Microchip Packaging Specification located at <http://www.microchip.com/packaging>

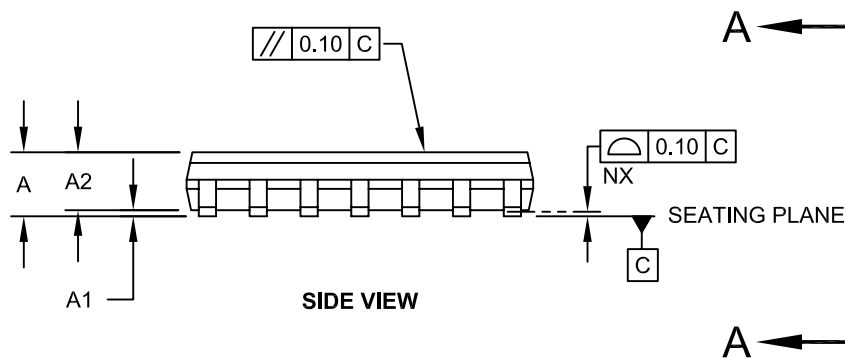
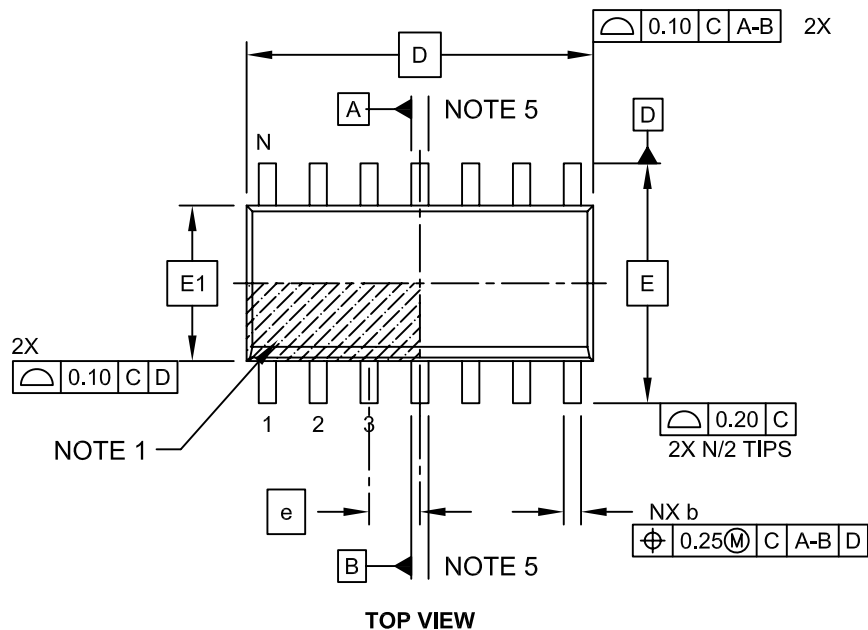

Microchip Technology Drawing No. C04-065C Sheet 1 of 2

# MCP6541/1R/1U/2/3/4

## 14-Lead Plastic Small Outline (SL) - Narrow, 3.90 mm Body [SOIC]

**Note:** For the most current package drawings, please see the Microchip Packaging Specification located at <http://www.microchip.com/packaging>



Dimension Limits	Units	MILLIMETERS		
		MIN	NOM	MAX
Number of Pins	N	14		
Pitch	e	1.27 BSC		
Overall Height	A	-	-	1.75
Molded Package Thickness	A2	1.25	-	-
Standoff §	A1	0.10	-	0.25
Overall Width	E	6.00 BSC		
Molded Package Width	E1	3.90 BSC		
Overall Length	D	8.65 BSC		
Chamfer (Optional)	h	0.25	-	0.50
Foot Length	L	0.40	-	1.27
Footprint	L1	1.04 REF		
Lead Angle	θ	0°	-	-
Foot Angle	φ	0°	-	8°
Lead Thickness	c	0.10	-	0.25
Lead Width	b	0.31	-	0.51
Mold Draft Angle Top	α	5°	-	15°
Mold Draft Angle Bottom	β	5°	-	15°

### Notes:

- Pin 1 visual index feature may vary, but must be located within the hatched area.
- § Significant Characteristic
- Dimension D does not include mold flash, protrusions or gate burrs, which shall not exceed 0.15 mm per end. Dimension E1 does not include interlead flash or protrusion, which shall not exceed 0.25 mm per side.
- Dimensioning and tolerancing per ASME Y14.5M  
BSC: Basic Dimension. Theoretically exact value shown without tolerances.  
REF: Reference Dimension, usually without tolerance, for information purposes only.
- Datums A & B to be determined at Datum H.

Microchip Technology Drawing No. C04-065C Sheet 2 of 2

# MCP6541/1R/1U/2/3/4

14-Lead Plastic Small Outline (SL) - Narrow, 3.90 mm Body [SOIC]

**Note:** For the most current package drawings, please see the Microchip Packaging Specification located at <http://www.microchip.com/packaging>



RECOMMENDED LAND PATTERN

Dimension Limits	Units	MILLIMETERS		
		MIN	NOM	MAX
Contact Pitch	E	1.27 BSC		
Contact Pad Spacing	C		5.40	
Contact Pad Width	X			0.60
Contact Pad Length	Y			1.50
Distance Between Pads	Gx	0.67		
Distance Between Pads	G	3.90		

**Notes:**

1. Dimensioning and tolerancing per ASME Y14.5M

BSC: Basic Dimension. Theoretically exact value shown without tolerances.

Microchip Technology Drawing No. C04-2065A

# MCP6541/1R/1U/2/3/4

## 14-Lead Plastic Thin Shrink Small Outline (ST) - 4.4 mm Body [TSSOP]

**Note:** For the most current package drawings, please see the Microchip Packaging Specification located at <http://www.microchip.com/packaging>

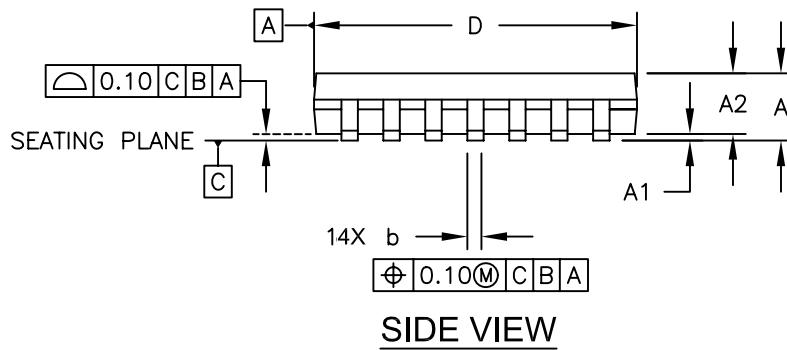

Microchip Technology Drawing C04-087C Sheet 1 of 2

# MCP6541/1R/1U/2/3/4

## 14-Lead Plastic Thin Shrink Small Outline (ST) - 4.4 mm Body [TSSOP]

**Note:** For the most current package drawings, please see the Microchip Packaging Specification located at <http://www.microchip.com/packaging>



Dimension Limits	Units	MILLIMETERS		
		MIN	NOM	MAX
Number of Pins	N	14		
Pitch	e	0.65 BSC		
Overall Height	A	-	-	1.20
Molded Package Thickness	A2	0.80	1.00	1.05
Standoff	A1	0.05	-	0.15
Overall Width	E	6.40 BSC		
Molded Package Width	E1	4.30	4.40	4.50
Molded Package Length	D	4.90	5.00	5.10
Foot Length	L	0.45	0.60	0.75
Footprint	(L1)	1.00 REF		
Foot Angle	$\varphi$	0°	-	8°
Lead Thickness	c	0.09	-	0.20
Lead Width	b	0.19	-	0.30

### Notes:

1. Pin 1 visual index feature may vary, but must be located within the hatched area.
2. Dimensions D and E1 do not include mold flash or protrusions. Mold flash or protrusions shall not exceed 0.15mm per side.
3. Dimensioning and tolerancing per ASME Y14.5M

BSC: Basic Dimension. Theoretically exact value shown without tolerances.

REF: Reference Dimension, usually without tolerance, for information purposes only.

Microchip Technology Drawing No. C04-087C Sheet 2 of 2

# MCP6541/1R/1U/2/3/4

## 14-Lead Plastic Thin Shrink Small Outline (ST) - 4.4 mm Body [TSSOP]

**Note:** For the most current package drawings, please see the Microchip Packaging Specification located at <http://www.microchip.com/packaging>



### RECOMMENDED LAND PATTERN

Dimension Limits	Units	MILLIMETERS		
		MIN	NOM	MAX
Contact Pitch	E		0.65 BSC	
Contact Pad Spacing	C1		5.90	
Contact Pad Width (X14)	X1			0.45
Contact Pad Length (X14)	Y1			1.45
Distance Between Pads	G	0.20		

**Notes:**

1. Dimensioning and tolerancing per ASME Y14.5M

BSC: Basic Dimension. Theoretically exact value shown without tolerances.

Microchip Technology Drawing No. C04-2087A



## APPENDIX A: REVISION HISTORY

### Revision H (December 2011)

The following is the list of modifications:

1. Updated [Package Types](#) drawings to correctly show the device representation for the SC-70 package.
1. Updated package's temperatures in the [Temperature Characteristics](#) table.
2. Corrected the marking information table for the 5-Lead SC-70 package (MCP6541 and MCP6541U) in [Section 5.1 "Package Marking Information"](#).
3. Updated package outline drawings in [Section 5.1 "Package Marking Information"](#) to show all views for each package.
4. Minor editorial changes.

### Revision G (March 2011)

The following is the list of modifications:

1. Updated the marking information for the 5-Lead SC-70 package in [Section 5.1 "Package Marking Information"](#).

### Revision F (September 2007)

1. Corrected polarity of MCP6541U SOT-23-5 pin out diagram on front page.
2. [Section 5.0 "Packaging Information"](#): Updated package outline drawings per MarCom.

### Revision E (September 2006)

The following is the list of modifications:

1. Added MCP6541U pinout for the SOT-23-5 package.
2. Clarified Absolute Maximum Analog Input Voltage and Current Specifications.
3. Added applications write-ups on unused comparators.
4. Added disclaimer to package outline drawings.

### Revision D (May 2006)

The following is the list of modifications:

1. Added E-temp parts.
2. Changed  $V_{HYST}$  temperature specification to linear and quadratic temperature coefficients.
3. Changed specifications and plots for E-Temp.
4. Added section [3.0 "Pin Descriptions"](#).
5. Corrected package marking (See [Section 5.1 "Package Marking Information"](#)).
6. Added [Appendix A: "Revision History"](#).

### Revision C (September 2003)

- Undocumented changes.

### Revision B (November 2002)

- Undocumented changes.

### Revision A (March 2002)

- Original Release of this Document.

# MCP6541/1R/1U/2/3/4

---

NOTES:

# MCP6541/1R/1U/2/3/4

## PRODUCT IDENTIFICATION SYSTEM

To order or obtain information, e.g., on pricing or delivery, refer to the factory or the listed sales office.

<u>PART NO.</u>	<u>-X</u>	<u>/XX</u>	<b>Examples:</b>
Device	Temperature Range	Package	
<b>Device:</b>			
MCP6541:		Single Comparator	a) MCP6541T-I/LT: Tape and Reel, Industrial Temperature, 5LD SC-70.
MCP6541T:		Single Comparator (Tape and Reel) (SC-70, SOT-23, SOIC, MSOP)	b) MCP6541T-I/OT: Tape and Reel, Industrial Temperature, 5LD SOT-23.
MCP6541RT:		Single Comparator (Rotated - Tape and Reel) (SOT-23 only)	c) MCP6541-I/MS: Tape and Reel, Industrial Temperature, 8LD MSOP.
MCP6541UT:		Single Comparator (Tape and Reel) (SC-70, SOT-23; <b>SOT-23-5 is E-Temp only</b> )	d) MCP6541-E/P: Extended Temperature, 8LD PDIP.
MCP6542:		Dual Comparator	e) MCP6541-E/SN: Extended Temperature, 8LD SOIC.
MCP6542T:		Dual Comparator (Tape and Reel for SOIC and MSOP)	f) MCP6541RT-I/OT: Tape and Reel, Industrial Temperature, 5LD SOT23.
MCP6543:		Single Comparator with $\overline{CS}$	g) MCP6541UT-E/LT: Tape and Reel, Industrial Temperature, 5LD SC-70
MCP6543T:		Single Comparator with $\overline{CS}$ (Tape and Reel for SOIC and MSOP)	h) MCP6541UT-E/OT: Tape and Reel, Extended Temperature, 5LD SOT23.
MCP6544:		Quad Comparator	a) MCP6542-I/MS: Industrial Temperature, 8LD MSOP.
MCP6544T:		Quad Comparator (Tape and Reel for SOIC and TSSOP)	b) MCP6542T-I/MS: Tape and Reel, Industrial Temperature, 8LD MSOP.
<b>Temperature Range:</b>	I = -40°C to +85°C		c) MCP6542-I/P: Industrial Temperature, 8LD PDIP.
	E * = -40°C to +125°C		d) MCP6542-E/SN: Extended Temperature, 8LD SOIC.
	* SC-70-5 E-Temp parts not available at this release of the data sheet.		a) MCP6543-I/SN: Industrial Temperature, 8LD SOIC.
<b>Package:</b>			b) MCP6543T-I/SN: Tape and Reel, Industrial Temperature, 8LD SOIC.
	LT = Plastic Package (SC-70), 5-lead		c) MCP6543-I/P: Industrial Temperature, 8LD PDIP.
	OT = Plastic Small Outline Transistor (SOT-23), 5-lead		d) MCP6543-E/SN: Extended Temperature, 8LD SOIC.
	MS = Plastic MSOP, 8-lead		a) MCP6544T-I/SL: Tape and Reel, Industrial Temperature, 14LD SOIC.
	P = Plastic DIP (300 mil Body), 8-lead, 14-lead		b) MCP6544T-E/SL: Tape and Reel, Extended Temperature, 14LD SOIC.
	SN = Plastic SOIC (150 mil Body), 8-lead		c) MCP6544-I/P: Industrial Temperature, 14LD PDIP.
	SL = Plastic SOIC (150 mil Body), 14-lead (MCP6544)		d) MCP6544T-E/ST: Tape and Reel, Extended Temperature, 14LD TSSOP.
	ST = Plastic TSSOP (4.4mm Body), 14-lead (MCP6544)		

# MCP6541/1R/1U/2/3/4

---

NOTES:

---

**Note the following details of the code protection feature on Microchip devices:**

- Microchip products meet the specification contained in their particular Microchip Data Sheet.
- Microchip believes that its family of products is one of the most secure families of its kind on the market today, when used in the intended manner and under normal conditions.
- There are dishonest and possibly illegal methods used to breach the code protection feature. All of these methods, to our knowledge, require using the Microchip products in a manner outside the operating specifications contained in Microchip's Data Sheets. Most likely, the person doing so is engaged in theft of intellectual property.
- Microchip is willing to work with the customer who is concerned about the integrity of their code.
- Neither Microchip nor any other semiconductor manufacturer can guarantee the security of their code. Code protection does not mean that we are guaranteeing the product as “unbreakable.”

Code protection is constantly evolving. We at Microchip are committed to continuously improving the code protection features of our products. Attempts to break Microchip's code protection feature may be a violation of the Digital Millennium Copyright Act. If such acts allow unauthorized access to your software or other copyrighted work, you may have a right to sue for relief under that Act.

---

Information contained in this publication regarding device applications and the like is provided only for your convenience and may be superseded by updates. It is your responsibility to ensure that your application meets with your specifications. MICROCHIP MAKES NO REPRESENTATIONS OR WARRANTIES OF ANY KIND WHETHER EXPRESS OR IMPLIED, WRITTEN OR ORAL, STATUTORY OR OTHERWISE, RELATED TO THE INFORMATION, INCLUDING BUT NOT LIMITED TO ITS CONDITION, QUALITY, PERFORMANCE, MERCHANTABILITY OR FITNESS FOR PURPOSE. Microchip disclaims all liability arising from this information and its use. Use of Microchip devices in life support and/or safety applications is entirely at the buyer's risk, and the buyer agrees to defend, indemnify and hold harmless Microchip from any and all damages, claims, suits, or expenses resulting from such use. No licenses are conveyed, implicitly or otherwise, under any Microchip intellectual property rights.

**Trademarks**

The Microchip name and logo, the Microchip logo, dsPIC, KEELOQ, KEELOQ logo, MPLAB, PIC, PICmicro, PICSTART, PIC<sup>32</sup> logo, rfPIC and UNI/O are registered trademarks of Microchip Technology Incorporated in the U.S.A. and other countries.

FilterLab, Hampshire, HI-TECH C, Linear Active Thermistor, MXDEV, MXLAB, SEEVAL and The Embedded Control Solutions Company are registered trademarks of Microchip Technology Incorporated in the U.S.A.

Analog-for-the-Digital Age, Application Maestro, chipKIT, chipKIT logo, CodeGuard, dsPICDEM, dsPICDEM.net, dsPICworks, dsSPEAK, ECAN, ECONOMONITOR, FanSense, HI-TIDE, In-Circuit Serial Programming, ICSP, Mindi, MiWi, MPASM, MPLAB Certified logo, MPLIB, MPLINK, mTouch, Omniscient Code Generation, PICC, PICC-18, PICDEM, PICDEM.net, PICKit, PICtail, REAL ICE, rfLAB, Select Mode, Total Endurance, TSHARC, UniWinDriver, WiperLock and ZENA are trademarks of Microchip Technology Incorporated in the U.S.A. and other countries.

SQTP is a service mark of Microchip Technology Incorporated in the U.S.A.

All other trademarks mentioned herein are property of their respective companies.

© 2002-2011, Microchip Technology Incorporated, Printed in the U.S.A., All Rights Reserved.

 Printed on recycled paper.

ISBN: 978-1-61341-921-2

*Microchip received ISO/TS-16949:2009 certification for its worldwide headquarters, design and wafer fabrication facilities in Chandler and Tempe, Arizona; Gresham, Oregon and design centers in California and India. The Company's quality system processes and procedures are for its PIC<sup>®</sup> MCUs and dsPIC<sup>®</sup> DSCs, KEELOQ<sup>®</sup> code hopping devices, Serial EEPROMs, microperipherals, nonvolatile memory and analog products. In addition, Microchip's quality system for the design and manufacture of development systems is ISO 9001:2000 certified.*

---

**QUALITY MANAGEMENT SYSTEM**  
**CERTIFIED BY DNV**  
**== ISO/TS 16949:2009 ==**



# MICROCHIP

## Worldwide Sales and Service

### AMERICAS

**Corporate Office**  
2355 West Chandler Blvd.  
Chandler, AZ 85224-6199  
Tel: 480-792-7200  
Fax: 480-792-7277  
Technical Support:  
<http://www.microchip.com/support>  
Web Address:  
[www.microchip.com](http://www.microchip.com)

**Atlanta**  
Duluth, GA  
Tel: 678-957-9614  
Fax: 678-957-1455

**Boston**  
Westborough, MA  
Tel: 774-760-0087  
Fax: 774-760-0088

**Chicago**  
Itasca, IL  
Tel: 630-285-0071  
Fax: 630-285-0075

**Cleveland**  
Independence, OH  
Tel: 216-447-0464  
Fax: 216-447-0643

**Dallas**  
Addison, TX  
Tel: 972-818-7423  
Fax: 972-818-2924

**Detroit**  
Farmington Hills, MI  
Tel: 248-538-2250  
Fax: 248-538-2260

**Indianapolis**  
Noblesville, IN  
Tel: 317-773-8323  
Fax: 317-773-5453

**Los Angeles**  
Mission Viejo, CA  
Tel: 949-462-9523  
Fax: 949-462-9608

**Santa Clara**  
Santa Clara, CA  
Tel: 408-961-6444  
Fax: 408-961-6445

**Toronto**  
Mississauga, Ontario,  
Canada  
Tel: 905-673-0699  
Fax: 905-673-6509

### ASIA/PACIFIC

**Asia Pacific Office**  
Suites 3707-14, 37th Floor  
Tower 6, The Gateway  
Harbour City, Kowloon  
Hong Kong  
Tel: 852-2401-1200  
Fax: 852-2401-3431

**Australia - Sydney**  
Tel: 61-2-9868-6733  
Fax: 61-2-9868-6755

**China - Beijing**  
Tel: 86-10-8569-7000  
Fax: 86-10-8528-2104

**China - Chengdu**  
Tel: 86-28-8665-5511  
Fax: 86-28-8665-7889

**China - Chongqing**  
Tel: 86-23-8980-9588  
Fax: 86-23-8980-9500

**China - Hangzhou**  
Tel: 86-571-2819-3187  
Fax: 86-571-2819-3189

**China - Hong Kong SAR**  
Tel: 852-2401-1200  
Fax: 852-2401-3431

**China - Nanjing**  
Tel: 86-25-8473-2460  
Fax: 86-25-8473-2470

**China - Qingdao**  
Tel: 86-532-8502-7355  
Fax: 86-532-8502-7205

**China - Shanghai**  
Tel: 86-21-5407-5533  
Fax: 86-21-5407-5066

**China - Shenyang**  
Tel: 86-24-2334-2829  
Fax: 86-24-2334-2393

**China - Shenzhen**  
Tel: 86-755-8203-2660  
Fax: 86-755-8203-1760

**China - Wuhan**  
Tel: 86-27-5980-5300  
Fax: 86-27-5980-5118

**China - Xian**  
Tel: 86-29-8833-7252  
Fax: 86-29-8833-7256

**China - Xiamen**  
Tel: 86-592-2388138  
Fax: 86-592-2388130

**China - Zhuhai**  
Tel: 86-756-3210040  
Fax: 86-756-3210049

### ASIA/PACIFIC

**India - Bangalore**  
Tel: 91-80-3090-4444  
Fax: 91-80-3090-4123

**India - New Delhi**  
Tel: 91-11-4160-8631  
Fax: 91-11-4160-8632

**India - Pune**  
Tel: 91-20-2566-1512  
Fax: 91-20-2566-1513

**Japan - Osaka**  
Tel: 81-66-152-7160  
Fax: 81-66-152-9310

**Japan - Yokohama**  
Tel: 81-45-471-6166  
Fax: 81-45-471-6122

**Korea - Daegu**  
Tel: 82-53-744-4301  
Fax: 82-53-744-4302

**Korea - Seoul**  
Tel: 82-2-554-7200  
Fax: 82-2-558-5932 or  
82-2-558-5934

**Malaysia - Kuala Lumpur**  
Tel: 60-3-6201-9857  
Fax: 60-3-6201-9859

**Malaysia - Penang**  
Tel: 60-4-227-8870  
Fax: 60-4-227-4068

**Philippines - Manila**  
Tel: 63-2-634-9065  
Fax: 63-2-634-9069

**Singapore**  
Tel: 65-6334-8870  
Fax: 65-6334-8850

**Taiwan - Hsin Chu**  
Tel: 886-3-5778-366  
Fax: 886-3-5770-955

**Taiwan - Kaohsiung**  
Tel: 886-7-536-4818  
Fax: 886-7-330-9305

**Taiwan - Taipei**  
Tel: 886-2-2500-6610  
Fax: 886-2-2508-0102

**Thailand - Bangkok**  
Tel: 66-2-694-1351  
Fax: 66-2-694-1350

### EUROPE

**Austria - Wels**  
Tel: 43-7242-2244-39  
Fax: 43-7242-2244-393

**Denmark - Copenhagen**  
Tel: 45-4450-2828  
Fax: 45-4485-2829

**France - Paris**  
Tel: 33-1-69-53-63-20  
Fax: 33-1-69-30-90-79

**Germany - Munich**  
Tel: 49-89-627-144-0  
Fax: 49-89-627-144-44

**Italy - Milan**  
Tel: 39-0331-742611  
Fax: 39-0331-466781

**Netherlands - Drunen**  
Tel: 31-416-690399  
Fax: 31-416-690340

**Spain - Madrid**  
Tel: 34-91-708-08-90  
Fax: 34-91-708-08-91

**UK - Wokingham**  
Tel: 44-118-921-5869  
Fax: 44-118-921-5820

11/29/11

Компания «Life Electronics» занимается поставками электронных компонентов импортного и отечественного производства от производителей и со складов крупных дистрибьюторов Европы, Америки и Азии.

С конца 2013 года компания активно расширяет линейку поставок компонентов по направлению коаксиальный кабель, кварцевые генераторы и конденсаторы (керамические, пленочные, электролитические), за счёт заключения дистрибьюторских договоров

Мы предлагаем:

- Конкурентоспособные цены и скидки постоянным клиентам.
- Специальные условия для постоянных клиентов.
- Подбор аналогов.
- Поставку компонентов в любых объемах, удовлетворяющих вашим потребностям.
- Приемлемые сроки поставки, возможна ускоренная поставка.
- Доставку товара в любую точку России и стран СНГ.
- Комплексную поставку.
- Работу по проектам и поставку образцов.
- Формирование склада под заказчика.
- Сертификаты соответствия на поставляемую продукцию (по желанию клиента).
- Тестирование поставляемой продукции.
- Поставку компонентов, требующих военную и космическую приемку.
- Входной контроль качества.
- Наличие сертификата ISO.

В составе нашей компании организован Конструкторский отдел, призванный помогать разработчикам, и инженерам.

Конструкторский отдел помогает осуществить:

- Регистрацию проекта у производителя компонентов.
- Техническую поддержку проекта.
- Защиту от снятия компонента с производства.
- Оценку стоимости проекта по компонентам.
- Изготовление тестовой платы монтаж и пусконаладочные работы.



Тел: +7 (812) 336 43 04 (многоканальный)

Email: [org@lifeelectronics.ru](mailto:org@lifeelectronics.ru)