

THIS COPY IS PROVIDED ON A RESTRICTED BASIS AND IS NOT TO BE USED IN ANY WAY DETRIMENTAL TO THE INTERESTS OF PANDUIT CORP.

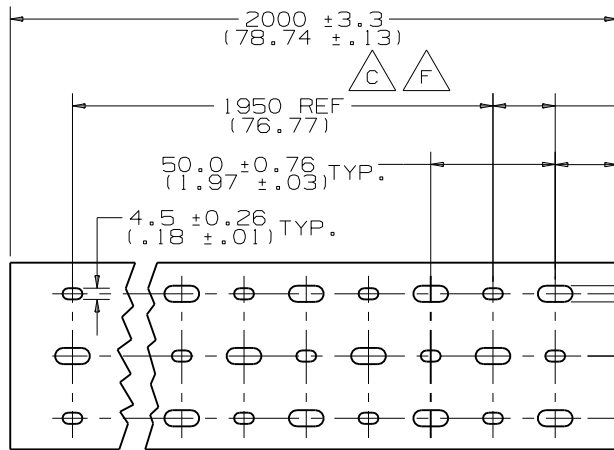

FOR 75mm, 100mm, WIDTH DUCT
MOUNTING HOLE DIMENSIONS

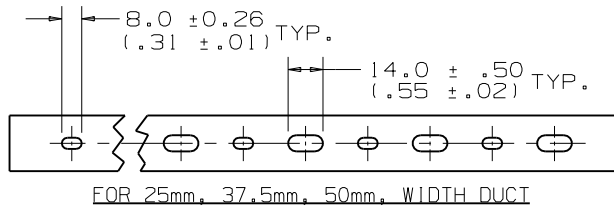
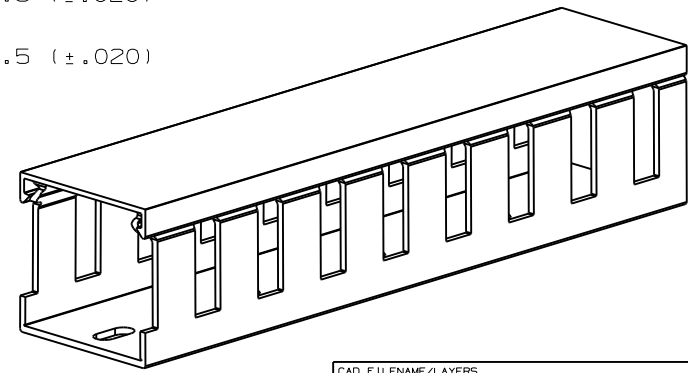
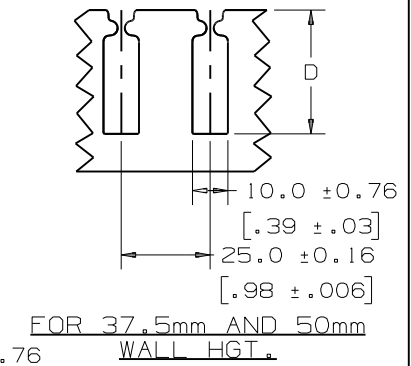
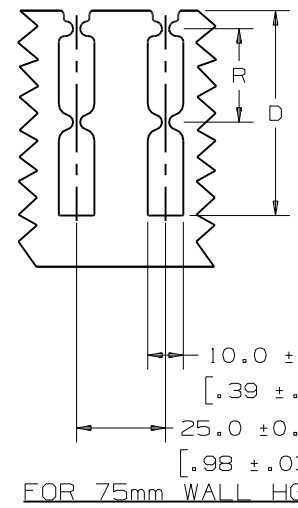
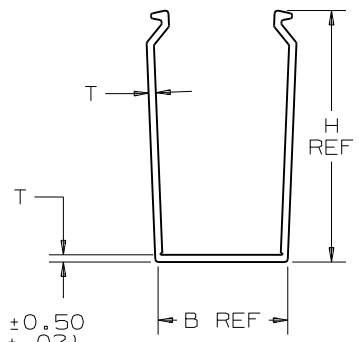

CHANNEL EXAMPLE:
 NNC 37 X 50 LG 2
 TYPE 37mm WIDE
 50mm HIGH
 COLOR (LIGHT GRAY)
 LENGTH (m)

- B**
- NOTES:
 1. "B" MEASURED AT BASE.
 2. STANDARD LENGTH: 2 METER.
 3. SEE CURRENT CATALOG FOR PART NUMBER DESIGNATIONS FOR TYPE, COLOR, AND LENGTH.
 4. DUCT TYPE "NNC" PACKAGED WITH TYPE "NC" COVER.
 5. DIMENSIONS ARE METRIC (INCHES).

CAD FILENAME/LAYERS		D38539AA_DC_NNC_01B.PRT	
<h1>PANDUIT</h1> CORP. TINLEY PARK, ILLINOIS WIRING DUCT AND COVER TYPE "NNC" METRIC CUSTOMER DRAWING			
UNLESS OTHERWISE SPECIFIED, DIMENSIONAL TOLERANCES ARE:		UNLESS OTHERWISE SPECIFIED, ALL DIMENSIONS ARE GIVEN IN INCHES, THIRD ANGLE PROJECTION.	
(.X) ±	(.XXX) ±		
(.XX) ± 3.1	ANGLES ±		
DRAWN BY	MAT'L: HALOGEN FREE MODIFIED POLYPHENYLENE OXIDE (PPO)	SCALE	NONE
DATE		DRAWING NO.	DWG
8-2-02		38539-04	A
CHK'D		Sht 1 of 3	SIZE
JKG			

REV	DATE	BY	CHK	DESCRIPTION	ECN	R	CUST	SUP
I	9-18-06	JCST	JKG	B. CHANGED NOTES A. ADDED NEW SIZES	38539-04	JKG	JKG	
R	11-2-02	JHNU JCST	JKG	RELEASED TO PRODUCTION	38539-04	HIW	HIW	

THIS COPY IS PROVIDED ON A RESTRICTED BASIS AND IS NOT TO BE USED IN ANY WAY DETRIMENTAL TO THE INTERESTS OF PANDUIT CORP.



PROFILE DIMENSION				
NOMINAL DUCT SIZE (W X H)	B REF	H REF	T	T TOL.
25 X 25	24.6 (.97)	20.5 (.81)	1.4 (.06)	±.26 (.010)
25 X 37	24.6 (.97)	33.0 (1.30)	1.4 (.06)	±.26 (.010)
25 X 50	24.6 (.97)	45.5 (1.79)	2.0 (.08)	±.30 (.012)
25 X 75	24.6 (.97)	70.5 (2.78)	1.7 (.07)	±.30 (.012)
37 X 37	37.1 (1.46)	33.0 (1.30)	1.8 (.07)	±.30 (.012)
37 X 50	37.1 (1.46)	45.5 (1.79)	2.0 (.08)	±.30 (.012)
37 X 75	37.1 (1.46)	70.5 (2.78)	2.0 (.08)	±.36 (.014)
50 X 50	49.6 (1.95)	45.5 (1.79)	2.0 (.08)	±.30 (.012)
50 X 75	49.6 (1.95)	70.5 (2.78)	2.0 (.08)	±.36 (.014)
50 X 100	49.6 (1.95)	95.5 (3.76)	2.2 (.09)	±.40 (.016)
75 X 75	74.6 (2.94)	70.5 (2.78)	2.0 (.08)	±.40 (.016)
100 X 50	99.6 (3.92)	45.5 (1.79)	2.0 (.08)	±.40 (.016)
100 X 75	98.6 (3.92)	70.5 (2.78)	2.5 (.10)	±.50 (.020)
100 X 100	99.6 (3.92)	95.5 (3.76)	2.5 (.10)	±.50 (.020)



MOUNTING HOLE	
NOMINAL DUCT WIDTH	K
25	±.5 (.02)
37	----
50	----
75	25.0 (.98)
100	25.0 (.98)



SLOT DIMENSION		
NOMINAL DUCT HEIGHT	D	R
25	±.8 (.03)	±.75 (.02)
37	13.6 (.54)	-----
50	24.7 (.97)	-----
75	34.8 (1.37)	-----
100	57.6 (2.27)	26.26 (1.03)
	81.0 (3.19)	38.0 (1.50)

ALL DIMENSIONS ARE METRIC (INCHES)

CAD FILENAME/LAYERS D38539AA_DC_NNC_01B.PRT

PANDUIT CORP. TINLEY PARK, ILLINOIS

WIRING DUCT AND COVER
TYPE "NNC" METRIC
CUSTOMER DRAWING

UNLESS OTHERWISE SPECIFIED,
DIMENSIONAL TOLERANCES ARE:
(.X) ± (.XXX) ±
(.XX) ± 3.1 (.12) ANGLES ±

UNLESS OTHERWISE SPECIFIED,
ALL DIMENSIONS ARE GIVEN
IN INCHES, THIRD ANGLE PROJECTION.

REV	DATE	BY	CHK	DESCRIPTION	ECN	CHK	CUST	SUP
I	9-18-06	JCST	JKG	SEE SHEET 1 OF 3 FOR REVISIONS	38539-04	JKG	JKG	
R	11-2-02	JHNU JCST	JKG	SEE SHEET 1 OF 3 FOR REVISIONS	38539-04	HIW	HIW	

DRAWN BY JHNU
DATE 8-2-02
CHK'D JKG

MAT'L: HALOGEN FREE
MODIFIED
POLYPHENYLENE
OXIDE
(PPO)

SCALE NONE
DRAWING NO. 38539-04
SHT 2 OF 3
DWG A
SIZE



THIS COPY IS PROVIDED ON A RESTRICTED BASIS AND IS NOT TO BE USED IN ANY WAY DETRIMENTAL TO THE INTERESTS OF PANDUIT CORP.

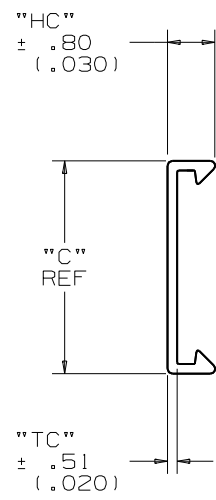
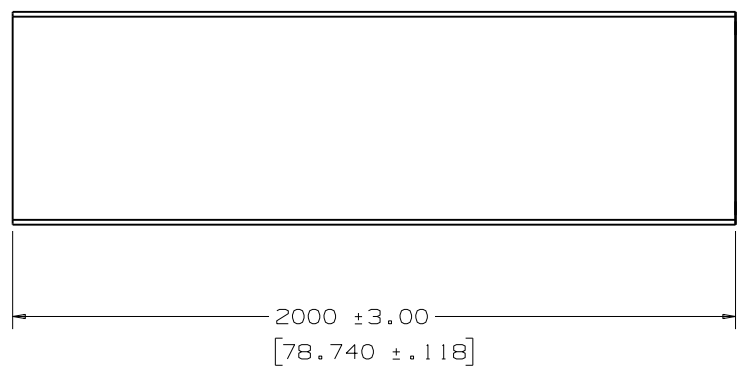

NOMINAL DUCT SIZE (W)	C REF	HC	TC
25	24.6 (.97)	8.9 (.35)	1.30 (.05)
37	37.1 (1.46)	8.9 (.35)	1.30 (.05)
50	49.6 (1.95)	8.9 (.35)	1.40 (.06)
75	74.6 (2.94)	9.4 (.37)	1.40 (.06)
100	99.6 (3.92)	9.4 (.37)	1.40 (.06)

ALL DIMENSIONS ARE METRIC (INCHES)

CAD FILENAME/LAYERS D38539AA_DC_NNC_01B

REV	DATE	BY	CHK	DESCRIPTION	ECN	R	CUST	SUP
I	9-18-06	JCST	JKG	SEE SHEET 1 OF 3 FOR REVISIONS	38539-04	JKG	JKG	
R	11-2-02	JHNU JCST	JKG	SEE SHEET 1 OF 3 FOR REVISIONS	38539-04	HIW	HIW	

PANDUIT CORP TINLEY PARK, ILLINOIS
 WIRING DUCT AND COVER
 TYPE "NNC" METRIC
 CUSTOMER DRAWING

UNLESS OTHERWISE SPECIFIED, DIMENSIONAL TOLERANCES ARE: (.X) ± .01 (.XX) ± .01		UNLESS OTHERWISE SPECIFIED, ALL DIMENSIONS ARE GIVEN IN INCHES, THIRD ANGLE PROJECTION.	
DRAWN BY JHNU	MAT'L: HALOGEN FREE MODIFIED POLYPHENYLENE OXIDE (PPO)	SCALE NONE	
DATE 8-2-02		DRAWING NO. 38539-04	DWG A
CHK'D JKG		SHT 3 OF 3	SIZE



Компания «Life Electronics» занимается поставками электронных компонентов импортного и отечественного производства от производителей и со складов крупных дистрибьюторов Европы, Америки и Азии.

С конца 2013 года компания активно расширяет линейку поставок компонентов по направлению коаксиальный кабель, кварцевые генераторы и конденсаторы (керамические, пленочные, электролитические), за счёт заключения дистрибьюторских договоров

Мы предлагаем:

- Конкурентоспособные цены и скидки постоянным клиентам.
- Специальные условия для постоянных клиентов.
- Подбор аналогов.
- Поставку компонентов в любых объемах, удовлетворяющих вашим потребностям.
- Приемлемые сроки поставки, возможна ускоренная поставка.
- Доставку товара в любую точку России и стран СНГ.
- Комплексную поставку.
- Работу по проектам и поставку образцов.
- Формирование склада под заказчика.
- Сертификаты соответствия на поставляемую продукцию (по желанию клиента).
- Тестирование поставляемой продукции.
- Поставку компонентов, требующих военную и космическую приемку.
- Входной контроль качества.
- Наличие сертификата ISO.

В составе нашей компании организован Конструкторский отдел, призванный помогать разработчикам, и инженерам.

Конструкторский отдел помогает осуществить:

- Регистрацию проекта у производителя компонентов.
- Техническую поддержку проекта.
- Защиту от снятия компонента с производства.
- Оценку стоимости проекта по компонентам.
- Изготовление тестовой платы монтаж и пусконаладочные работы.



Тел: +7 (812) 336 43 04 (многоканальный)

Email: org@lifeelectronics.ru