



ENERGY RECOVERY PRODUCTS™



SLM Series 90-160 W

Tri-Mode Dimming (TRIAC, ELV & 0-10 V) High Power CC LED Drivers with 0.01-100% Dimming Range

Input Voltage	Max. Output Power	Output Voltage	Output Current	Efficiency	Max. Case Temperature	THD	Power Factor	Dimming Method	Dimming Range	Startup Time
120 to 277 Vac typical	160 W	21 to 85 Vdc	1.8 A to 3.9 A CC	≥ 90% typical	90°C (measured at the hot spot)	< 20%	> 0.9	Reverse-Phase & 0 - 10V	0.01 - 100% (% of lout)	0.5 sec

CC: Constant Current

PRODUCT DESCRIPTION

The SLM series of LED drivers is ideally suited for LED lighting applications in stage and studio environments. These devices are compatible with most industry standard, reverse-phase (trailing edge) wall-based dimmers, and 0-10V wall-based dimmers and offer deep dimming from 100% down to 0.01%.

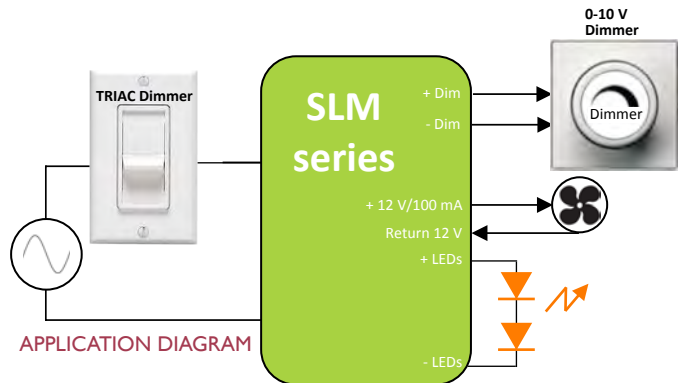

FEATURES

- Compatible with ELV (reverse-phase or trailing-edge) and 0-10 V dimmers
- TRIAC and ELV dimming only at 120 Vac
- 12 V/100 mA auxiliary output
- Protections: output open load, short-circuit (latch-off), and over-temperature with auto recovery
- Conducted and radiated EMI: Compliant with FCC CFR Title 47 Part 15 Class A (120 and 277 Vac) and EN55015 (CISPR 15) at 220/230/240 Vac
- Enables ENERGY STAR® and DLC (DesignLight Consortium®) luminaire compliance
- IP64-rated case with silicone-based potting
- 90°C maximum case hot spot temperature
- Double-insulated power supply between input and output (class II)
- Worldwide safety approvals



ALUMINUM CASE:
L 101.6 x W 50.8 x H 38.5mm
(L 4 x W 2 x H 1.52 in)

APPLICATIONS

- Stage lighting
- Studio lighting
- LED display signage

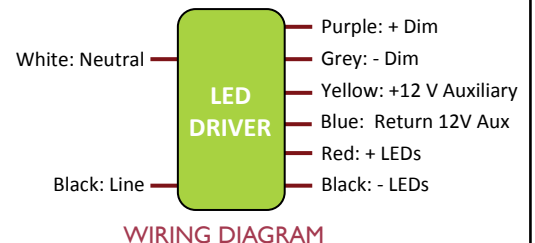



ENERGY RECOVERY PRODUCTS™

**SLM Series 90-160 W**

Tri-Mode Dimming (TRIAC, ELV & 0-10 V) High Power CC LED Drivers with 0.01-100% Dimming Range

1 - INPUT SPECIFICATION (@25°C ambient temperature)

	Units	Minimum	Typical	Maximum	Notes
Input Voltage Range (Vin)	Vac	90	120/220/230/ 240/277	305	The rated output current for each model is achieved at Vin ≥ 115 Vac and at Vin ≥ 209 Vac, at nominal load.
Input Frequency Range	Hz	47	60	63	
Power Factor (PF)		0.9	> 0.9		At nominal input voltage and with nominal LED voltage
Inrush Current	Meets NEMA-410 requirements				At any point on the sine wave and 25°C
Leakage Current	µA			500 µA	Measured at nominal input voltage per IEC60950-1
Input Harmonics	Complies with IEC61000-3-2 for Class C equipment				
Total Harmonics Distortion (THD)				20%	<ul style="list-style-type: none"> •At nominal input voltage and nominal LED voltage •Complies with DLC (DesignLight Consortium) technical requirements v2.1
Efficiency	%	-	90%	-	Measured with nominal input voltage, a full sinusoidal wave form and without dimmer connected
Isolation	Meets UL60950-1 for class II reinforced/double insulation power supply <input type="checkbox"/>				

2 - OUTPUT SPECIFICATION (@25°C ambient temperature)

	Units	Minimum	Typical	Maximum	Notes
MAIN CONSTANT CURRENT OUTPUT					
Output Voltage (Vout)	Vdc	21		85	See ordering information for details
Output Current (Iout)	mA	1800		3900	<ul style="list-style-type: none"> •See ordering information for details •The rated output current for each model is achieved at Vin ≥ 115 Vac and at Vin ≥ 209 Vac, at nominal load.
Output Current Regulation	%	-5	±2.5	5	<ul style="list-style-type: none"> •At nominal AC line voltage •Includes load and current set point variations
Output Current Overshoot	%	-	-	10	The driver does not operate outside of the regulation requirements for more than 500 ms during power on with nominal LED load and without dimmer.
Ripple Current	≤ 40% of rated output current for each model ≤ 45% for SLM160W-3.9-40 ≤ 50% for SLM160W-1.8-85				<ul style="list-style-type: none"> •Measured at nominal LED voltage and nominal input voltage without dimming. •Calculated in accordance with the IES Lighting Handbook, 9th edition.
Dimming Range (% of Iout)	%	0.1		100	The dimming range will be dependent on each specific dimmer.
Start-up Time	s		0.5		With nominal LED voltage, nominal AC line voltage and without dimmer attached
12 V AUXILIARY CONSTANT VOLTAGE OUTPUT					
Output Voltage (Vout)	Vdc	10.2	12	13.2	The voltage regulation is +10%/-15% and the ripple voltage shall be ≤ 0.4V.
Output Current (Iout)	mA		100		
OUTPUT CONTROLS					
+Dim Signal, -Dim Signal	The +Dim/-Dim signal pins can be used to adjust the output setting via a standard commercial wall dimmer, an external control voltage source (0 to 10 Vdc), or a variable resistor when using the recommended number of LEDs. The dimming input permits 0.1% to 100% dimming.				



ENERGY RECOVERY PRODUCTS™



SLM Series 90-160 W

Tri-Mode Dimming (TRIAC, ELV & 0-10 V) High Power CC LED Drivers with 0.01-100% Dimming Range

3 - ENVIRONMENTAL CONDITIONS

	Units	Minimum	Typical	Maximum	Notes
Operating Case Temperature (Tc)	°C	-20		+90	Case temperature measured at the hot spot •tc (see label in page)
Storage Temperature	°C	-40		+85	
Humidity	%	5	-	95	Non-condensing
Cooling	Forced air cooling is required for continuous power exceeding 120 W				
Acoustic Noise	dBA			24	Measured at a distance of 1 foot (30 cm) without and with approved dimmers
Mechanical Shock Protection	per EN60068-2-27				
Vibration Protection	per EN60068-2-6 & EN60068-2-64				
MTBF	> 200,000 hours when operated at nominal input and output conditions, and at Tc ≤ 70°C				
Lifetime (See graphs "Lifetime vs. Case and Ambient Temperature" in section)	<ul style="list-style-type: none"> •50,000 hours at Tc = 70°C •Measured at the hot spot (see hot spot •tc on label in page) 				

4 - EMC COMPLIANCE AND SAFETY APPROVALS

EMC Compliance					
Conducted and Radiated EMI	<ul style="list-style-type: none"> •FCC CFR Title 47 Part 15 Class A at 120 Vac and Class A at 277 Vac •EN55015 (CISPR 15) at 220/230/240 Vac 				
Harmonic Current Emissions	IEC61000-3-2	For Class C equipment			
Voltage Fluctuations & Flicker	IEC61000-3-3				
Immunity Compliance	ESD (Electrostatic Discharge)	IEC61000-4-2	6 kV contact discharge, 8 kV air discharge, level 3		
	RF Electromagnetic Field Susceptibility	IEC61000-4-3	3 V/m, 80 - 1000 MHz, 80% modulated at a distance of 3 meters		
	Electrical Fast Transient	IEC61000-4-4	± 2 kV on AC power port for 1 minute, ±1 kV on signal/control lines		
	Surge	IEC61000-4-5	± 2 kV line to line (differential mode) / ± 4 kV line to common mode ground (tested to secondary ground) on AC power port, ±0.5 kV for outdoor cables		
	Conducted RF Disturbances	IEC61000-4-6	3 V, 0.15-80 MHz, 80% modulated		
	Voltage Dips	IEC61000-4-11	>95% dip, 0.5 period; 30% dip, 25 periods; 95% reduction, 250 periods		
Transient Protection	Ring Wave	ANSI/IEEE c62.41.1-2002 & c62.41.2-2002 category A, 2.5 kV ring wave			

Safety Agency Approvals		
UL	UL8750 recognized	
cUL	CSA C22.2 No.250.13-14	

Safety					
	Units	Minimum	Typical	Maximum	Notes
Hi Pot (High Potential)	Vdc	2500			<ul style="list-style-type: none"> •Insulation between the input (AC line and Neutral) and the output •Tested at the RMS voltage equivalent of 1768 Vac



ENERGY RECOVERY PRODUCTS™



SLM Series 90-160 W

Tri-Mode Dimming (TRIAC, ELV & 0-10 V) High Power CC LED Drivers with 0.01-100% Dimming Range

■ 5 - PROTECTION FEATURES

Under-Voltage (Brownout)

The SLM series provides protection circuitry such that an application of an input voltage below the minimum stated in paragraph 1 (Input Specification) shall not cause damage to the driver.

Short Circuit

The SLM series is protected such that a short from any output to return shall not result in a fire hazard or shock hazard. In the event of a short, the driver shuts down and latches off as a result of short circuit fault for main output. Removal of fault and AC recycling returns the driver to normal operation.

Internal Over temperature Protection

The SLM series incorporates circuitry that prevents internal damage due to an over temperature condition. An over temperature condition may be a result of an excessive ambient temperature or as a result of an internal failure. When the over temperature condition is removed, the driver shall automatically recover.

Output Open Load

When the LED load is removed, the output voltage of the SLM series is limited to 1.3 times the maximum output voltage of each model.

230 Vac Protection

The SLM series is compatible with ELV dimming only at 120 Vac. 230 Vac ELV dimming is not supported in the SLM series. However, in the event that someone tries to TRIAC-dim or ELV-dim the SLM series at 230 Vac, it has been added a protection to clamp the internal bus and keep it in safe operating mode.



ENERGY RECOVERY PRODUCTS™



SLM Series 90-160 W

Tri-Mode Dimming (TRIAC, ELV & 0-10 V) High Power CC LED Drivers with 0.01-100% Dimming Range

6 - PHASE-CUT DIMMING

The SLM series offers dual dimming compatibility with reverse-phase (trailing-edge) phase-cut ELV dimmers and 0–10V dimmers. ELV dimming is only offered at 120 Vac.

Figures 1 and 2 show the typical output current versus conduction angle at nominal input voltage.

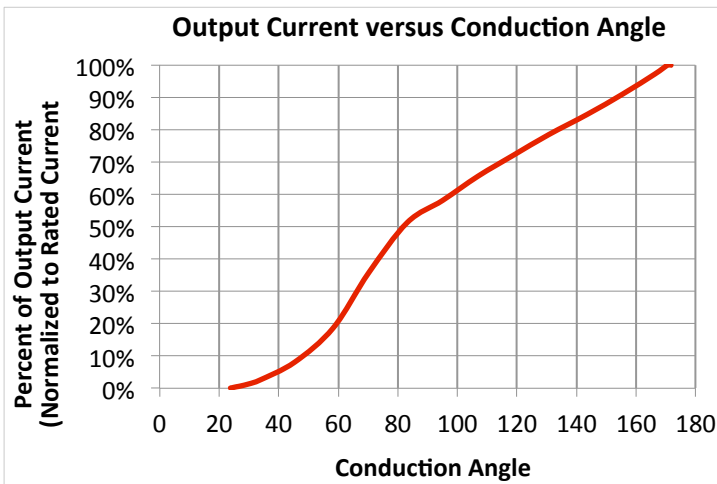

Figure 1

7 - COMPATIBLE PHASE-CUT ELV DIMMERS

- Leviton: Vizia VPE06
- Leviton: IllumaTech IPE04
- Lutron: Diva DVELV-303P
- Lutron: Skylark SELV-300P
- Lutron: Mestro MAELV-600
- Lutron: Faedra FAELV-500
- Lightolier: Sunrise ZP260QE

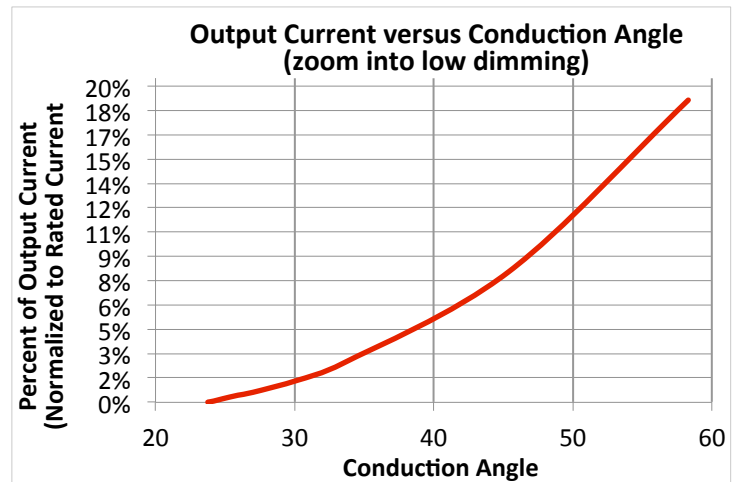

Figure 2



Tri-Mode Dimming (TRIAC, ELV & 0-10 V) High Power CC LED Drivers with 0.01-100% Dimming Range

8 - 0-10V DIMMING

The SLM drivers operate only with 0-10V dimmers that sink current. They are not designed to operate with 0-10V control systems that source current, as used in theatrical/entertainment systems. Developed in the 1980's, the 0-10V sinking current control method is adopted by the International Electrotechnical Commission (IEC) as part of their IEC Standard 60929 Annex E.

The method to dim the output current of the driver is done via the +Dim/-Dim Signal pins. The +Dim/-Dim Signal pins respond to a 0 to 10 V signal, delivering 1% to 100% of the output current based on rated current for each model. A pull-up resistor is included internal to the driver. When the +Dim input (purple) is short circuited to the -Dim wire (grey) or to the -LED wire (black), there is no output current. When the +Dim input (purple) is ≤ 1 V, the output current is programmed to $\leq 10\%$ of rated current. If the +Dim input is >10 V or open circuited, the output current is programmed to 100% of the rated current.

When not used, the -Dim wire (grey) and to the +Dim wire (purple) can be capped or cut off. In this configuration, no dimming is possible and the driver delivers 100% of its rated output current.

The maximum source current (flowing from the driver to the 0-10V dimmer) supplied by the +Dim Signal pin is ≤ 2.5 mA. The tolerance of the output current while being dimmed shall be $\pm 8\%$ typical until down to 2V.

Figure 3 shows the 0-10V dimming transfer function.

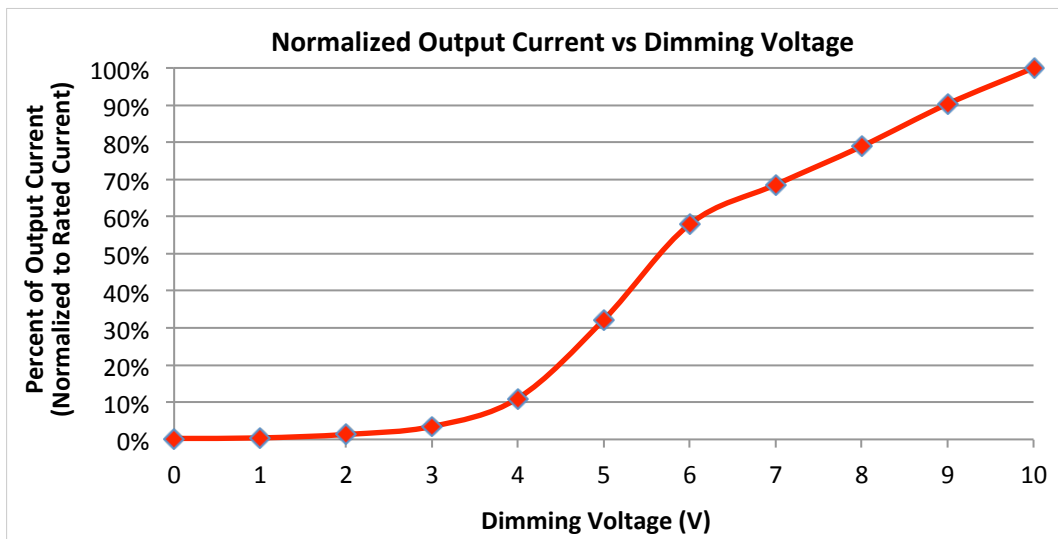

Figure 3

9 - COMPATIBLE 0-10V DIMMERS

- Lutron, Nova series (part number NFTV)
- Lutron, Diva series (part number DVTV)
- Leviton: IllumaTech IP710-DL



ENERGY RECOVERY PRODUCTS™



SLM Series 90-160 W

Tri-Mode Dimming (TRIAC, ELV & 0-10 V) High Power CC LED Drivers with 0.01-100% Dimming Range

I0 - MECHANICAL DETAILS

- Packaging Options:** Aluminum extruded case
- I/O Connections:** Flying leads, 18 AWG on power leads, 18 AWG on control leads, 203 mm (8 in) long, 105°C rated, stranded, stripped by approximately 9.5mm, and tinned. All the wires, on both input and output, have a 300 V insulation rating.
- Ingress Protection:** IP64 rated
- Mounting Instructions:** The driver must be secured on a flat surface through the four mounting tabs, shown here below in the case outline drawings

II - OUTLINE DRAWINGS

- Dimensions:** L 101.6 x W 50.8 x H 38.5 mm (L 4.0 x W 2.0 x H 1.52 in)
- Volume:** 198.7 cm³ (12.13 in³)
- Weight:**

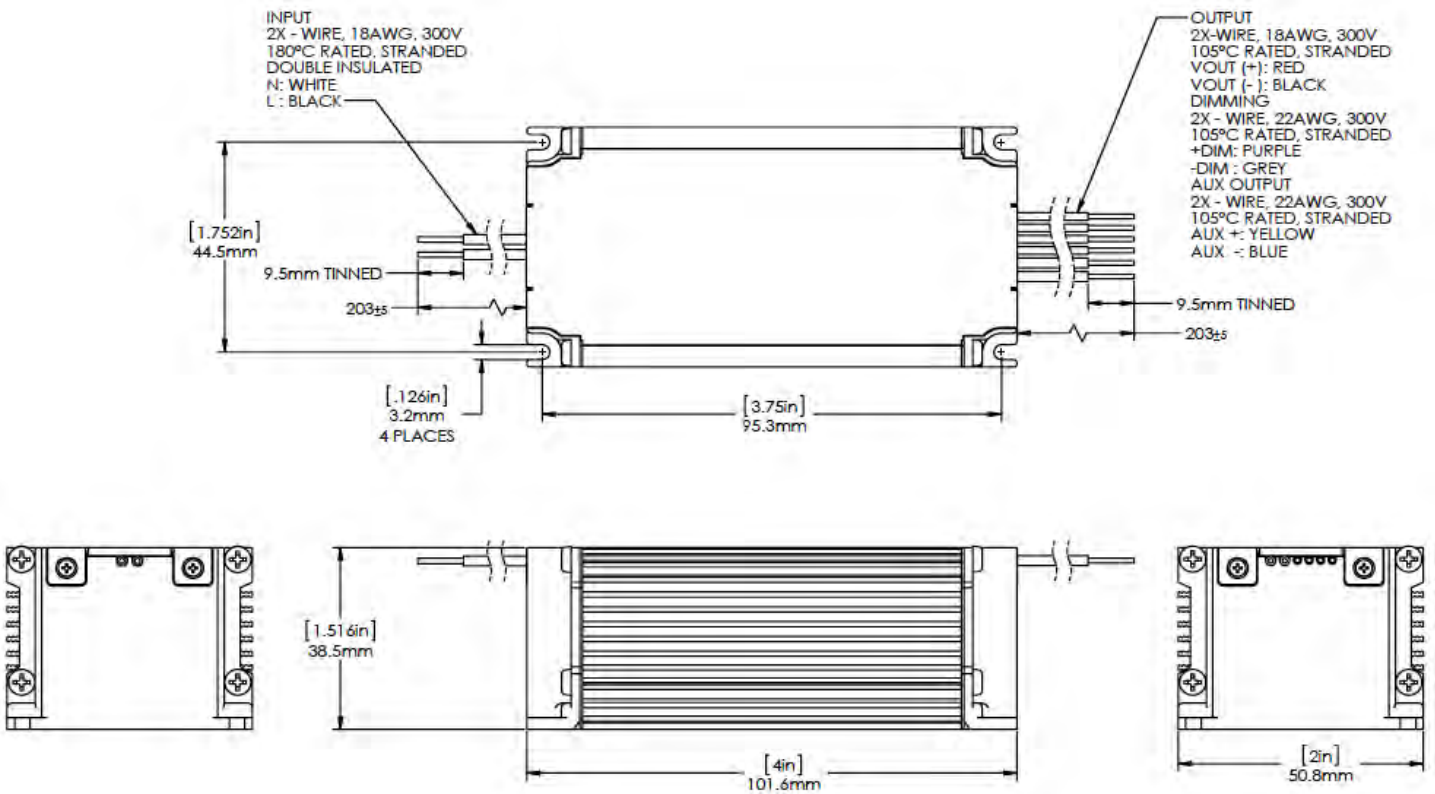

Figure 4



ENERGY RECOVERY PRODUCTS™



SLM Series 90-160 W

Tri-Mode Dimming (TRIAC, ELV & 0-10 V) High Power CC LED Drivers with 0.01-100% Dimming Range

12 - ORDERING INFORMATION - MODEL DESCRIPTION

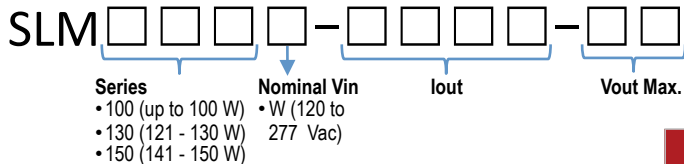

Notes:

- Forced air cooling is required for total continuous power exceeding 120 W
- For additional options of output current and output voltage, contact your sales representative or send an email to: SaveEnergy@ERPPowerLLC.com

	Ordering Part Number	Input Voltage Range (Vac)	Max Output Power (W)	Iout (A)	Vout min (Vdc)	Vout Nom (Vdc)	Vout Max (Vdc)	No Load Voltage (Vdc)
120 VAC	SLM100W: 90 to 100 W (1%-100% dimming)							
	SLM100W-2.8-34	120 to 277	95.2	2.8	27	30.6	34	44.2
	SLM140W: 131 to 140 W (1%-100% dimming)							
	SLM140W-2.8-50	120 to 277	140.0	2.8	40	45.0	50	60
	SLM150W: 141 to 150 W (1%-100% dimming)							
	SLM150W-3.0-48	120 to 277	144.0	3	38.4	43.2	48	60
	SLM160W: 151 to 160 W (1%-100% dimming)							
	SLM160W-1.8-85	120 to 277	153.0	1.8	68	76.5	85	100
	SLM160W-3.7-42	120 to 277	155.4	3.7	30	37.8	42	50
	SLM160W-3.9-40	120 to 277	156.0	3.9	30	36.0	40	50
	SLM160W-4.4-36	120 to 277	158.4	4.4	28	32.4	36	46.8
	SLM100W: 90 to 100 W (0.01%-100% dimming)							
	SLM100W-2.8-34-P01	120 to 277	95.2	2.8	27	30.6	34	44.2
	SLM140W: 131 to 140 W (0.01%-100% dimming)							
	SLM140W-2.8-50-P01	120 to 277	140.0	2.8	40	45.0	50	60
	SLM160W: 151 to 160 W (0.01%-100% dimming)							
	SLM160W-1.8-85-P01	120 to 277	153.0	1.8	68	76.5	85	100
	SLM160W-4.4-36-P01	120 to 277	158.4	4.4	28	32.4	36	46.8
220-240 VAC	SLM100E: 90 to 100 W (1%-100% dimming)							
	SLM100E-2.8-34	220 to 240	95.2	2.8	27	30.6	34	44.2
	SLM140E: 131 to 140 W (1%-100% dimming)							
	SLM140E-2.8-50	220 to 240	140.0	2.8	40	45.0	50	60
	SLM160E: 151 to 160 W (1%-100% dimming)							
	SLM160E-1.8-85	220 to 240	153.0	1.8	68	76.5	85	100
	SLM160E-3.9-42	220 to 240	163.8	3.9	30	37.8	42	50
	SLM160E-4.4-36	220 to 240	158.4	4.4	28	32.4	36	46.8
	SLM140E: 131 to 140 W (0.01%-100% dimming)							
	SLM140E-2.8-50-P01	220 to 240	140.0	2.8	40	45.0	50	60
	SLM160E: 151 to 160 W (0.01%-100% dimming)							
	SLM160E-1.8-85-P01	220 to 240	153.0	1.8	68	76.5	85	100
SLM160E-4.4-36-P01	220 to 240	158.4	4.4	28	32.4	36	46.8	



ENERGY RECOVERY PRODUCTS™



SLM Series 90-160 W

Tri-Mode Dimming (TRIAC, ELV & 0-10 V) High Power CC LED Drivers with 0.01-100% Dimming Range

■ I3 - LABELING

Figure 5

USA Headquarters

Tel: +1-805-517-1300
Fax: +1-805-517-1411
301 Science Drive, Suite 210
Moorpark, CA 93021, USA

CHINA Operations

Tel: +86-756-6266298
Fax: +86-756-6266299
No. 8 Pingdong Road 2
Zhuhai, Guangdong, China 519060

ERP - Energy Recovery Products (ERP Power, LLC) - reserves the right to make changes without further notice to any products herein. ERP makes no warranty, representation or guarantee regarding the suitability of its products for any particular purpose, nor does ERP assume any liability arising out of the application or use of any product or circuit, and specifically disclaims any and all liability, including without limitation special, consequential or incidental damages. "Typical" parameters which may be provided in ERP data sheets and/or specifications can and do vary in different applications and actual performance may vary over time. All operating parameters, including "Typicals" must be validated for each customer application by customer's technical experts. ERP does not convey any license under its patent rights nor the rights of others. ERP products are not designed, intended, or authorized for use as components in systems intended for surgical implant into the body, or other applications intended to support or sustain life, or for any other application in which the failure of the ERP product could create a situation where personal injury or death may occur. Should Buyer purchase or use ERP products for any such unintended or unauthorized application, Buyer shall indemnify and hold ERP and its officers, employees, subsidiaries, affiliates, and distributors harmless against all claims, costs, damages, and expenses, and reasonable attorney fees arising out of, directly or indirectly, any claim of personal injury or death associated with such unintended or unauthorized use, even if such claim alleges that ERP was negligent regarding the design or manufacture of the part. ERP is an Equal Opportunity/Affirmative Action Employer. This literature is subject to all applicable copyright laws and is not for resale in any manner.

Компания «Life Electronics» занимается поставками электронных компонентов импортного и отечественного производства от производителей и со складов крупных дистрибьюторов Европы, Америки и Азии.

С конца 2013 года компания активно расширяет линейку поставок компонентов по направлению коаксиальный кабель, кварцевые генераторы и конденсаторы (керамические, пленочные, электролитические), за счёт заключения дистрибьюторских договоров

Мы предлагаем:

- Конкуренеспособные цены и скидки постоянным клиентам.
- Специальные условия для постоянных клиентов.
- Подбор аналогов.
- Поставку компонентов в любых объемах, удовлетворяющих вашим потребностям.
- Приемлемые сроки поставки, возможна ускоренная поставка.
- Доставку товара в любую точку России и стран СНГ.
- Комплексную поставку.
- Работу по проектам и поставку образцов.
- Формирование склада под заказчика.
- Сертификаты соответствия на поставляемую продукцию (по желанию клиента).
- Тестирование поставляемой продукции.
- Поставку компонентов, требующих военную и космическую приемку.
- Входной контроль качества.
- Наличие сертификата ISO.

В составе нашей компании организован Конструкторский отдел, призванный помогать разработчикам, и инженерам.

Конструкторский отдел помогает осуществить:

- Регистрацию проекта у производителя компонентов.
- Техническую поддержку проекта.
- Защиту от снятия компонента с производства.
- Оценку стоимости проекта по компонентам.
- Изготовление тестовой платы монтаж и пусконаладочные работы.



Тел: +7 (812) 336 43 04 (многоканальный)
Email: org@lifeelectronics.ru