

# MAX98357A/MAX98357B

## PCM Input Class D Audio Power Amplifiers

### General Description

The MAX98357A/MAX98357B are digital pulse-code modulation (PCM) input Class D power amplifiers that provide Class AB audio performance with Class D efficiency. These ICs offer five selectable gain settings (3dB, 6dB, 9dB, 12dB, and 15dB) in I<sup>2</sup>S/left-justified mode set by a single gain select input and a fixed 12dB gain in TDM mode.

The digital audio interface is highly flexible with the MAX98357A supporting I<sup>2</sup>S data and the MAX98357B supporting left-justified data. Both ICs support 8 channel time division multiplexed (TDM) data. The digital audio interface accepts specified sample rates between 8kHz and 96kHz for all supported data formats. The ICs can be configured to produce a left channel, right channel, or (left/2 + right/2) output from the stereo input data. The ICs operate using 16/24/32-bit data for I<sup>2</sup>S and left-justified modes as well as 16-bit or 32-bit data using TDM mode. The ICs eliminate the need for the external MCLK signal that is typically used for PCM communication. This reduces EMI and possible board coupling issues in addition to reducing the size and pin count of the ICs.

The ICs also feature a very high wideband jitter tolerance (12ns typ) on BCLK and LRCLK to provide robust operation.

Active emissions-limiting, edge-rate limiting, and overshoot control circuitry greatly reduce EMI. A filterless spread-spectrum modulation scheme eliminates the need for output filtering found in traditional Class D devices and reduces the component count of the solution.

The ICs are available in 9-pin WLP (1.345mm x 1.435mm x 0.64mm) and 16-pin TQFN (3mm x 3mm x 0.75mm) packages and are specified over the -40°C to +85°C temperature range.

### Applications

Notebook and Netbook Computers  
Cellular Phones  
Tablets

**Ordering Information** appears at end of data sheet.

**Functional Diagram** appears at end of data sheet.

### Features

- ◆ Single-Supply Operation (2.5V to 5.5V)
- ◆ 3.2W Output Power into 4Ω at 5V
- ◆ 2.4mA Quiescent Current
- ◆ 92% Efficiency ( $R_L = 8\Omega$ ,  $P_{OUT} = 1W$ )
- ◆ 25μV<sub>RMS</sub> Output Noise ( $A_V = 15dB$ )
- ◆ Low 0.015% THD+N at 1kHz
- ◆ No MCLK Required
- ◆ Sample Rates of 8kHz to 96kHz
- ◆ Supports Left, Right, or (Left/2 + Right/2) Output
- ◆ Sophisticated Edge Rate Control Enables Filterless Class D Outputs
- ◆ 77dB PSRR at 1kHz
- ◆ Low RF Susceptibility Rejects TDMA Noise from GSM Radios
- ◆ Extensive Click-and-Pop Reduction Circuitry
- ◆ Robust Short-Circuit and Thermal Protection
- ◆ Available in Space-Saving Packages:  
1.345mm x 1.435mm WLP (0.4mm Pitch)  
and 3mm x 3mm TQFN

### Simplified Block Diagram

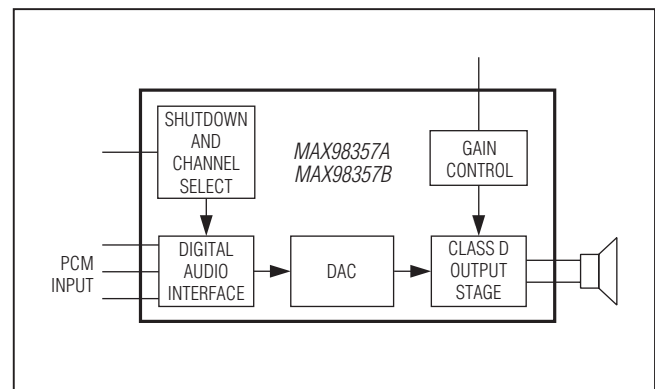

# MAX98357A/MAX98357B

## PCM Input Class D Audio Power Amplifiers

---

### TABLE OF CONTENTS

---

General Description . . . . .	1
Applications . . . . .	1
Features . . . . .	1
Simplified Block Diagram . . . . .	1
Absolute Maximum Ratings . . . . .	4
Package Thermal Characteristics . . . . .	4
Electrical Characteristics . . . . .	4
Typical Operating Characteristics . . . . .	9
General . . . . .	9
Speaker Amplifier . . . . .	9
Pin Configurations . . . . .	17
Pin Description . . . . .	17
Detailed Description . . . . .	18
Digital Audio Interface Modes . . . . .	18
MCLK Elimination . . . . .	18
BCLK Jitter Tolerance . . . . .	18
BCLK Polarity . . . . .	18
LRCLK Polarity . . . . .	18
Standby Mode . . . . .	19
DAC Digital Filters . . . . .	19
$\overline{\text{SD}}\text{MODE}$ and Shutdown Operation . . . . .	19
I <sup>2</sup> S and Left Justified Mode . . . . .	21
TDM Mode . . . . .	21
Class D Speaker Amplifier . . . . .	30
Ultra-Low EMI Filterless Output Stage . . . . .	30
Speaker Current Limit . . . . .	30
Gain Selection . . . . .	30
Click-and-Pop Suppression . . . . .	30
Applications Information . . . . .	31
Filterless Class D Operation . . . . .	35
Power-Supply Input . . . . .	35
Layout and Grounding . . . . .	35
Functional Diagram . . . . .	35
WLP Applications Information . . . . .	36
Ordering Information . . . . .	36
Package Information . . . . .	37
Revision History . . . . .	40
Maxim Integrated . . . . .	2

# MAX98357A/MAX98357B

## PCM Input Class D Audio Power Amplifiers

---

### LIST OF FIGURES

---

Figure 1. I <sup>2</sup> S Audio Interface Timing Diagram (MAX98357A) . . . . .	8
Figure 2. Left-Justified Audio Interface Timing Diagram (MAX98357B) . . . . .	8
Figure 3. TDM Audio Interface Timing Diagram. . . . .	8
Figure 4. SD_MODE Resistor Connected Using Open Drain Driver . . . . .	20
Figure 5. SD_MODE Resistor Connected Using Push-Pull Driver . . . . .	20
Figure 6. MAX98357A I <sup>2</sup> S Digital Audio Interface Timing, 16-Bit Resolution . . . . .	22
Figure 7. MAX98357A I <sup>2</sup> S Digital Audio Interface Timing, 32-Bit Resolution. . . . .	23
Figure 8. MAX98357B Left-Justified Digital Audio Interface Timing, 16-Bit Resolution . . . . .	24
Figure 9. MAX98357B Left-Justified Digital Audio Interface Timing, 32-Bit Resolution . . . . .	25
Figure 10. MAX98357A TDM 16-Bit DAI Timing . . . . .	26
Figure 11. MAX98357A TDM 32-Bit DAI Timing. . . . .	27
Figure 12. MAX98357B TDM 16-Bit DAI Timing . . . . .	28
Figure 13. MAX98357B TDM 32-Bit DAI Timing . . . . .	29
Figure 14. EMI with 12in of Speaker Cable and No Output Filtering . . . . .	30
Figure 15. Left-Channel PCM Operation with 6dB Gain . . . . .	31
Figure 16. Left-Channel PCM Operation with 12dB Gain . . . . .	31
Figure 17. Right-Channel PCM Operation with 6dB Gain . . . . .	32
Figure 18. (Left/2 + Right/2) PCM Operation with 6dB Gain. . . . .	32
Figure 19. Stereo PCM Operation Using Two ICs . . . . .	33
Figure 20. Channel TDM Operation (Gain Fixed at 12dB). . . . .	34
Figure 21. MAX98357A/MAX98357B WLP Ball Dimensions . . . . .	36

---

### LIST OF TABLES

---

Table 1. RMS Jitter Tolerance. . . . .	18
Table 2. BCLK Polarity . . . . .	18
Table 3. LRCLK Polarity . . . . .	18
Table 4. Digital Filter Settings. . . . .	19
Table 5. $\overline{\text{SD\_MODE}}$ Control. . . . .	19
Table 6. Examples of $\overline{\text{SD\_MODE}}$ Pullup Resistor Values . . . . .	19
Table 7. TDM Mode Channel Selection . . . . .	21
Table 8. Gain Selection . . . . .	30

# MAX98357A/MAX98357B

## PCM Input Class D Audio Power Amplifiers

### ABSOLUTE MAXIMUM RATINGS

$V_{DD}$ , LRCLK, BCLK, and DIN to GND	-0.3V to +6V	Continuous Power Dissipation ( $T_A = +70^\circ\text{C}$ )	
All Other Pins to GND	-0.3V to ( $V_{DD} + 0.3\text{V}$ )	WLP (derate 13.7mW/ $^\circ\text{C}$ above $+70^\circ\text{C}$ )	1096mW
Continuous Current In/Out of $V_{DD}$ /GND/OUT_	$\pm 1.6\text{A}$	TQFN (derate 20.8mW/ $^\circ\text{C}$ above $+70^\circ\text{C}$ )	1666mW
Continuous Input Current (all other pins)	$\pm 20\text{mA}$	Junction Temperature	$+150^\circ\text{C}$
Duration of OUT_ Short Circuit to GND or $V_{DD}$	Continuous	Operating Temperature Range	$-40^\circ\text{C}$ to $+85^\circ\text{C}$
Duration of OUTP Short to OUTN	Continuous	Storage Temperature Range	$-65^\circ\text{C}$ to $+150^\circ\text{C}$
		Soldering Temperature (reflow)	$+230^\circ\text{C}$

Stresses beyond those listed under "Absolute Maximum Ratings" may cause permanent damage to the device. These are stress ratings only, and functional operation of the device at these or any other conditions beyond those indicated in the operational sections of the specifications is not implied. Exposure to absolute maximum rating conditions for extended periods may affect device reliability.

### PACKAGE THERMAL CHARACTERISTICS (Note 1)

WLP	Junction-to-Ambient Thermal Resistance ( $\theta_{JA}$ )	$73^\circ\text{C}/\text{W}$	TQFN	Junction-to-Ambient Thermal Resistance ( $\theta_{JA}$ )	$48^\circ\text{C}/\text{W}$
	Junction-to-Case Thermal Resistance ( $\theta_{JC}$ )	$50^\circ\text{C}/\text{W}$		Junction-to-Case Thermal Resistance ( $\theta_{JC}$ )	$7^\circ\text{C}/\text{W}$

**Note 1:** Package thermal resistances were obtained using the method described in JEDEC specification JESD51-7, using a four-layer board. For detailed information on package thermal considerations, refer to [www.maximintegrated.com/thermal-tutorial](http://www.maximintegrated.com/thermal-tutorial).

### ELECTRICAL CHARACTERISTICS

( $V_{DD} = 5\text{V}$ ,  $V_{GND} = 0\text{V}$ , GAIN\_SLOT =  $V_{DD}$ , BCLK = 3.072MHz, LRCLK = 48kHz, speaker loads ( $Z_{SPK}$ ) connected between OUTP and OUTN,  $Z_{SPK} = \infty$ ,  $T_A = T_{MIN}$  to  $T_{MAX}$ , unless otherwise noted. Typical values are at  $T_A = +25^\circ\text{C}$ .) (Note 2)

PARAMETER	SYMBOL	CONDITIONS	MIN	TYP	MAX	UNITS
Supply Voltage Range	$V_{DD}$	Guaranteed by PSSR test	2.5		5.5	V
Undervoltage Lockout	UVLO		1.4	1.8	2.3	V
Quiescent Current	$I_{DD}$	$T_A = +25^\circ\text{C}$		2.75	3.35	mA
		$T_A = +25^\circ\text{C}$ , $V_{DD} = 3.7\text{V}$		2.4	2.85	
Shutdown Current	$I_{SHDN}$	$\overline{\text{SD\_MODE}} = 0\text{V}$ , $T_A = +25^\circ\text{C}$		0.6	2	$\mu\text{A}$
Standby Current	$I_{STNDBY}$	$\overline{\text{SD\_MODE}} = 1.8\text{V}$ , no BCLK, $T_A = +25^\circ\text{C}$		340	400	$\mu\text{A}$
Turn-On Time	$t_{ON}$			7	7.5	ms
Output Offset Voltage	$V_{OS}$	$T_A = +25^\circ\text{C}$ , gain = 15dB		$\pm 0.3$	$\pm 2.5$	mV
Click-and-Pop Level	$K_{CP}$	Peak voltage, $T_A = +25^\circ\text{C}$ , A-weighted, 32 samples per second (Note 3)	Into shutdown		-72	dBV
		Out of shutdown			-66	
Power-Supply Rejection Ratio	PSRR	$V_{DD} = 2.5\text{V}$ to $5.5\text{V}$ , $T_A = +25^\circ\text{C}$		60	75	dB
		$T_A = +25^\circ\text{C}$ (Notes 3, 4)	$f = 217\text{Hz}$ , 200mV <sub>P-P</sub> ripple		77	
			$f = 10\text{kHz}$ , 200mV <sub>P-P</sub> ripple		60	

# MAX98357A/MAX98357B

## PCM Input Class D Audio Power Amplifiers

### ELECTRICAL CHARACTERISTICS (continued)

( $V_{DD} = 5V$ ,  $V_{GND} = 0V$ ,  $GAIN\_SLOT = V_{DD}$ ,  $BCLK = 3.072MHz$ ,  $LRCLK = 48kHz$ , speaker loads ( $Z_{SPK}$ ) connected between OUTP and OUTN,  $Z_{SPK} = \infty$ ,  $T_A = T_{MIN}$  to  $T_{MAX}$ , unless otherwise noted. Typical values are at  $T_A = +25^\circ C$ .) (Note 2)

PARAMETER	SYMBOL	CONDITIONS	MIN	TYP	MAX	UNITS
Output Power (Note 3)	$P_{OUT}$	THD+N 10%, gain = 12dB	$Z_{SPK} = 4\Omega + 33\mu H$		3.2	W
			$Z_{SPK} = 8\Omega + 68\mu H$		1.8	
			$Z_{SPK} = 8\Omega + 68\mu H$ , $V_{DD} = 3.7V$		0.93	
		THD+N = 1%, gain = 12dB	$Z_{SPK} = 4\Omega + 33\mu H$		2.5	
			$Z_{SPK} = 8\Omega + 68\mu H$		1.4	
			$Z_{SPK} = 8\Omega + 68\mu H$ , $V_{DD} = 3.7V$		0.77	
Total Harmonic Distortion + Noise	THD+N	f = 1kHz, $P_{OUT} = 1W$ , $T_A = +25^\circ C$ , $Z_{SPK} = 4\Omega + 33\mu H$ , WLP		0.02	0.06	%
		f = 1kHz, $P_{OUT} = 1W$ , $T_A = +25^\circ C$ , $Z_{SPK} = 4\Omega + 33\mu H$ , TQFN		0.02		
		f = 1kHz, $P_{OUT} = 0.5W$ , $T_A = +25^\circ C$ , $Z_{SPK} = 8\Omega + 68\mu H$		0.013		
Dynamic Range	DR	A-weighted, $V_{RMS} = 2.54V$ , 24- or 32-bit data		105		dB
Output Noise	$V_N$	A-weighted, 24- or 32-bit data (Note 4)		25		$\mu V_{RMS}$
Gain (Relative to a 2.1dBV Reference Level)	$A_V$	$GAIN\_SLOT = GND$ through 100k $\Omega$	14.4	15	15.6	dB
		$GAIN\_SLOT = GND$	11.4	12	12.6	
		$GAIN\_SLOT =$ unconnected	8.4	9	9.6	
		$GAIN\_SLOT = V_{DD}$	5.4	6	6.6	
		$GAIN\_SLOT = V_{DD}$ through 100k $\Omega$	2.4	3	3.6	
Current Limit	$I_{LIM}$			2.8		A
Efficiency	$\epsilon$	$Z_{SPK} = 8\Omega + 68\mu H$ , THD+N = 10%, f = 1kHz, gain = 12dB		92		%
DAC Gain Error				1		%
Frequency Response			-0.2		+0.2	dB
Class D Switching Frequency	$f_{OSC}$			330		kHz
Spread-Spectrum Bandwidth				$\pm 20$		kHz
<b>DAC DIGITAL FILTERS</b>						
<b>VOICE MODE IIR LOWPASS FILTER (LRCLK &lt; 30kHz)</b>						
Passband Cutoff	$f_{PLP}$	Ripple limit cutoff	0.443			Hz
		-3dB cutoff	0.446			
Stopband Cutoff	$f_{SLP}$				0.464	Hz
Stopband Attenuation		f > $f_{SLP}$	75			dB

# MAX98357A/MAX98357B

## PCM Input Class D Audio Power Amplifiers

### ELECTRICAL CHARACTERISTICS (continued)

( $V_{DD} = 5V$ ,  $V_{GND} = 0V$ ,  $GAIN = V_{DD}$ . BCLK = 3.072MHz, LRCLK = 48kHz, speaker loads ( $Z_{SPK}$ ) connected between OUTP and OUTN,  $Z_{SPK} = \infty$ ,  $T_A = T_{MIN}$  to  $T_{MAX}$ , unless otherwise noted. Typical values are at  $T_A = +25^{\circ}C$ .) (Note 2)

PARAMETER	SYMBOL	CONDITIONS	MIN	TYP	MAX	UNITS
<b>AUDIO MODE FIR LOWPASS FILTER (30kHz &lt; LRCLK &lt; 50kHz)</b>						
Passband Cutoff	$f_{PLP}$	Ripple limit cutoff	0.43 $\times f_S$			Hz
		-3dB cutoff	0.47 $\times f_S$			
		-6.02dB cutoff	0.5 $\times f_S$			
Stopband Cutoff	$f_{SLP}$				0.58 $\times f_S$	Hz
Stopband Attenuation		$f > f_{SLP}$	60			dB
<b>AUDIO MODE FIR LOWPASS FILTER (LRCLK &gt; 50kHz)</b>						
Passband Cutoff	$f_{PLP}$	Ripple limit cutoff	0.24 $\times f_S$			Hz
		-3dB cutoff	0.31 $\times f_S$			
Stopband Cutoff	$f_{SLP}$				0.477 $\times f_S$	Hz
Stopband Attenuation		$f < f_{SLP}$	60			dB
<b>DIGITAL AUDIO INTERFACE</b>						
LRCLK Range 1	$f_{S1}$		7.6	8	8.4	kHz
LRCLK Range 2	$f_{S2}$		15.2	16	16.8	
LRCLK Range 3	$f_{S3}$		30.4	48	50.4	
LRCLK Range 4	$f_{S4}$		83.8	96	100.8	
Resolution		I <sup>2</sup> S/left justified mode	16/24/32			Bits
		TDM mode	16/32			
BCLK Frequency Range	$f_{BCLKH}$	BCLK must be 32, 48, or 64X of LRCLK	0.2432		25.804	MHz
BCLK High Time	$t_{BCLKH}$		15			ns
BCLK Low Time	$t_{BCLKL}$		15			ns
Maximum Low Frequency BCLK and LRCLK Jitter		RMS jitter below 40kHz	0.5			ns
Maximum High Frequency BCLK and LRCLK Jitter		RMS jitter above 40kHz	12			
Input High Voltage	$V_{IH}$	Digital audio inputs	1.3			V

# MAX98357A/MAX98357B

## PCM Input Class D Audio Power Amplifiers

### ELECTRICAL CHARACTERISTICS (continued)

( $V_{DD} = 5V$ ,  $V_{GND} = 0V$ ,  $GAIN = V_{DD}$ ,  $BCLK = 3.072MHz$ ,  $LRCLK = 48kHz$ , speaker loads ( $Z_{SPK}$ ) connected between  $OUTP$  and  $OUTN$ ,  $Z_{SPK} = \infty$ ,  $T_A = T_{MIN}$  to  $T_{MAX}$ , unless otherwise noted. Typical values are at  $T_A = +25^\circ C$ .) (Note 2)

PARAMETER	SYMBOL	CONDITIONS	MIN	TYP	MAX	UNITS
Input Low Voltage	$V_{IL}$	Digital audio inputs			0.6	V
Input Leakage Current	$I_{IH}, I_{IL}$	$V_{IN} = 0V$ , $V_{DD} = 5.5V$ , $T_A = +25^\circ C$	-1		+1	$\mu A$
Input Capacitance	$C_{IN}$			3		pF
DIN to BCLK Setup Time	$t_{SETUP}$		10			ns
LRCLK to BCLK Setup Time	$t_{SYNCSET}$		10			ns
DIN to BCLK Hold Time	$t_{HOLD}$		10			ns
LRCLK to BCLK Hold Time	$t_{SYNCHOLD}$		10			ns
<b>SD_MODE COMPARATOR TRIP POINTS</b>						
B0		See $\overline{SD\_MODE}$ and shutdown operation for details	0.08	0.16	0.355	V
B1			0.65	0.77	0.825	
B2			1.245	1.4	1.5	
$\overline{SD\_MODE}$ Pulldown Resistor	$R_{PD}$		92	100	108	$k\Omega$
<b>GAIN_SLOT COMPARATOR TRIP POINTS</b>						
	$V\_GAIN\_SLOT$	$A_V = 3dB$ gain	$0.65 \times V_{DD}$		$0.85 \times V_{DD}$	V
		$A_V = 6dB$ gain	$0.9 \times V_{DD}$		$V_{DD}$	
		$A_V = 9dB$ gain	$0.4 \times V_{DD}$		$0.6 \times V_{DD}$	
		$A_V = 12dB$ gain	0		$0.1 \times V_{DD}$	
		$A_V = 15dB$ gain	$0.15 \times V_{DD}$		$0.35 \times V_{DD}$	

**Note 2:** 100% production tested at  $T_A = +25^\circ C$ . Specifications over temperature limits are guaranteed by design.

**Note 3:** Class D amplifier testing performed with a resistive load in series with an inductor to simulate an actual speaker load. For  $R_L = 8\Omega$ ,  $L_L = 68\mu H$ . For  $R_L = 4\Omega$ ,  $L_L = 33\mu H$ .

**Note 4:** Digital silence used for input signal.

**Note 5:** Dynamic range measured using the EIAJ method. -60dBFS 1kHz output signal, A-weighted, and normalized to 0dBFS.  $f = 20Hz$  to  $20kHz$ .





# MAX98357A/MAX98357B

## PCM Input Class D Audio Power Amplifiers

### Typical Operating Characteristics

( $V_{DD} = 5V$ ,  $V_{GND} = 0V$ , GAIN\_SLOT = GND (+12dB). BCLK = 3.072MHz, LRCLK = 48kHz, speaker loads ( $Z_{SPK}$ ) connected between OUTP and OUTN,  $T_A = T_{MIN}$  to  $T_{MAX}$ , unless otherwise noted. Typical values are at  $T_A = +25^\circ C$ .)

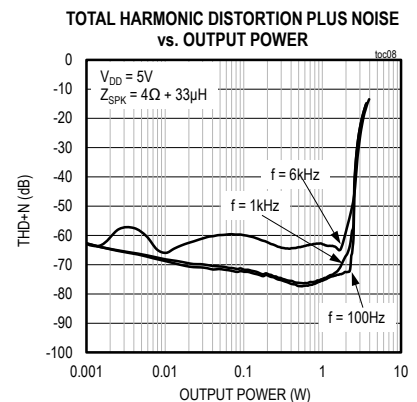
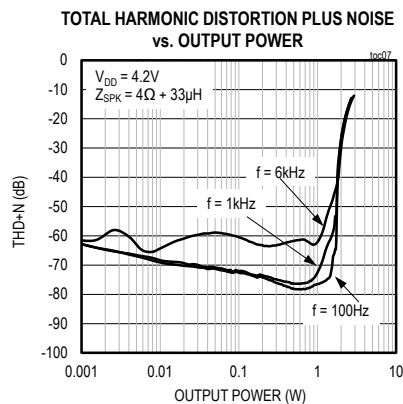
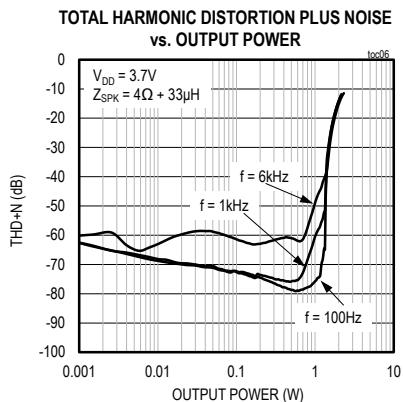
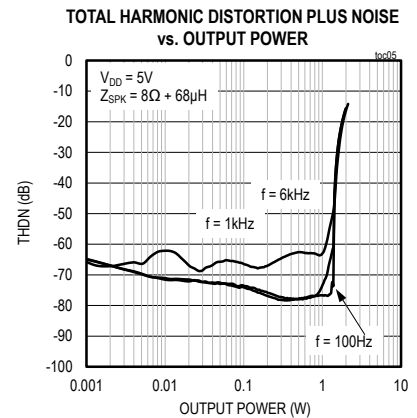
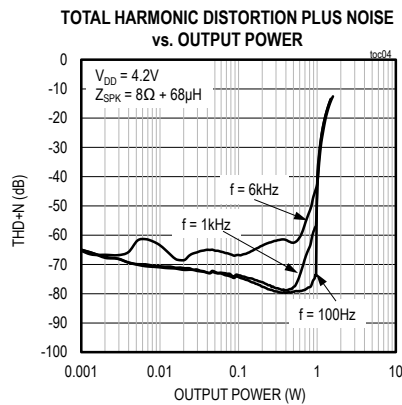
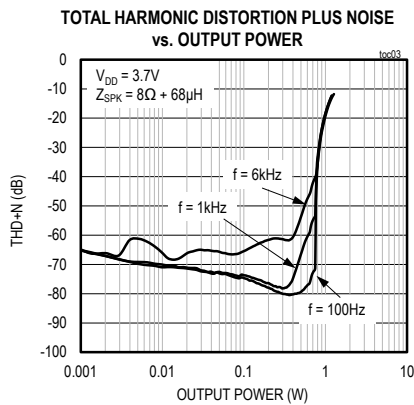
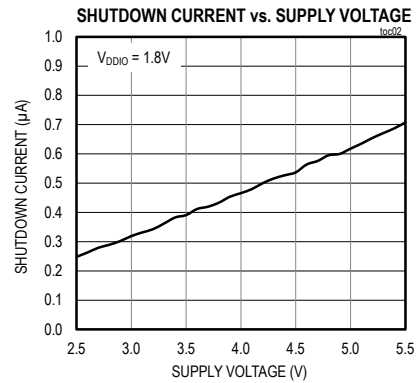
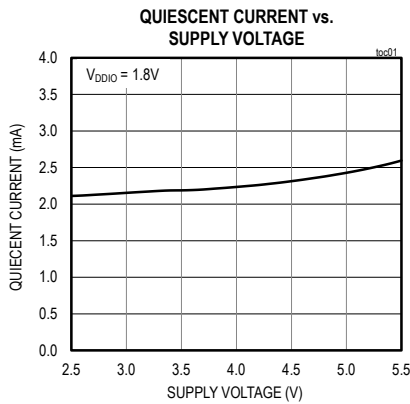

# MAX98357A/MAX98357B

## PCM Input Class D Audio Power Amplifiers

### Typical Operating Characteristics (continued)

( $V_{DD} = 5V$ ,  $V_{GND} = 0V$ , GAIN\_SLOT = GND (+12dB). BCLK = 3.072MHz, LRCLK = 48kHz, speaker loads ( $Z_{SPK}$ ) connected between OUTP and OUTN,  $T_A = T_{MIN}$  to  $T_{MAX}$ , unless otherwise noted. Typical values are at  $T_A = +25^\circ C$ .)

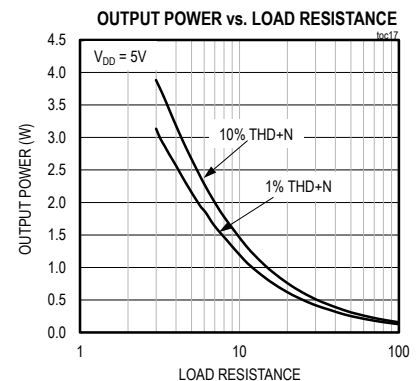
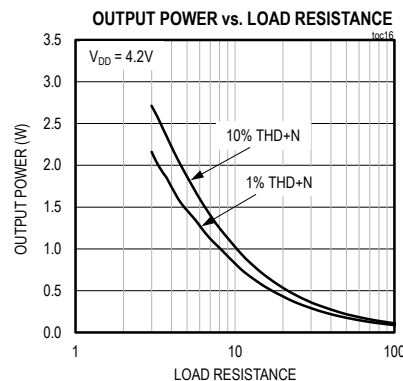
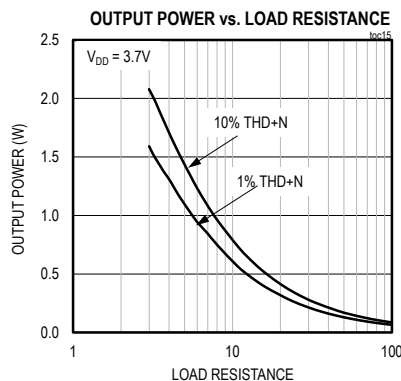
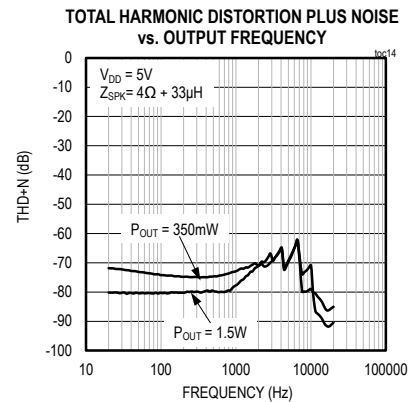
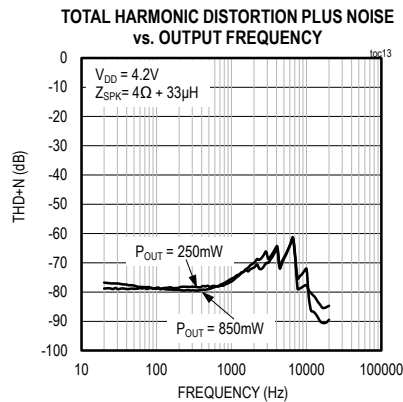
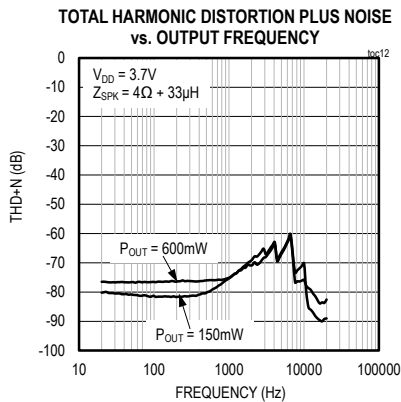
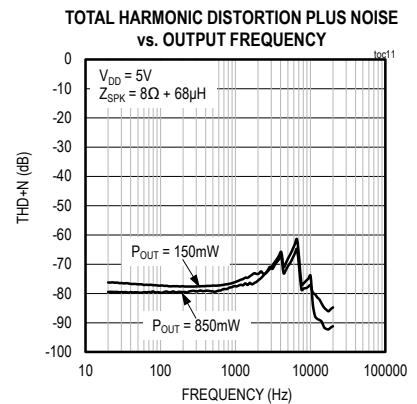
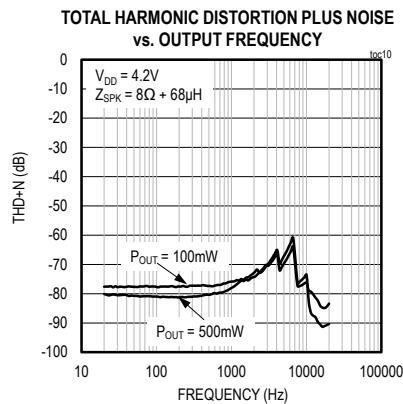
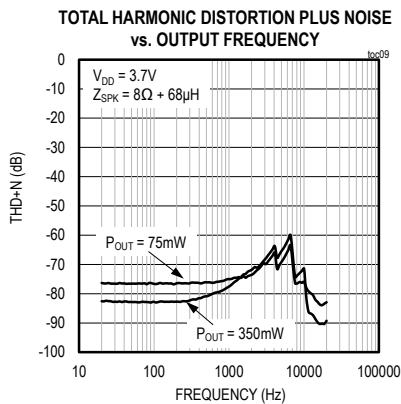

# MAX98357A/MAX98357B

## PCM Input Class D Audio Power Amplifiers

### Typical Operating Characteristics (continued)

( $V_{DD} = 5V$ ,  $V_{GND} = 0V$ , GAIN\_SLOT = GND (+12dB). BCLK = 3.072MHz, LRCLK = 48kHz, speaker loads ( $Z_{SPK}$ ) connected between OUTP and OUTN,  $T_A = T_{MIN}$  to  $T_{MAX}$ , unless otherwise noted. Typical values are at  $T_A = +25^\circ C$ .)

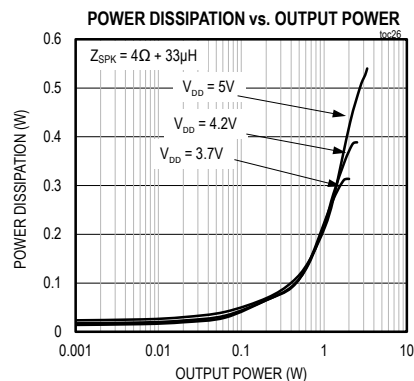
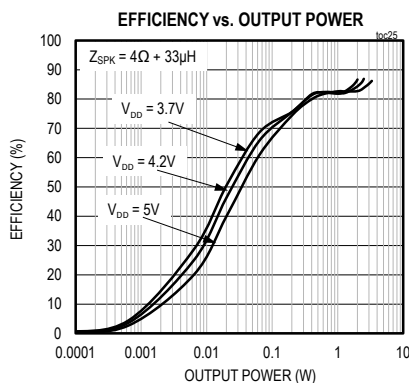
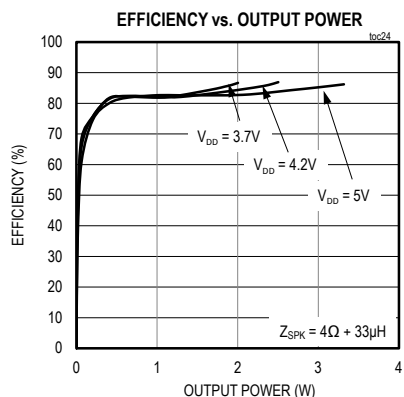
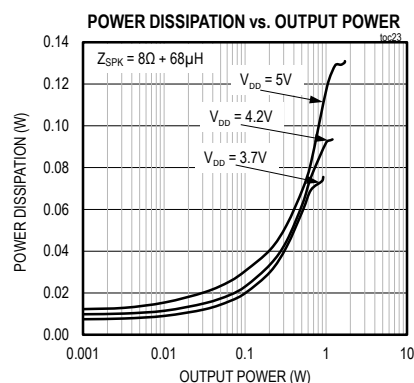
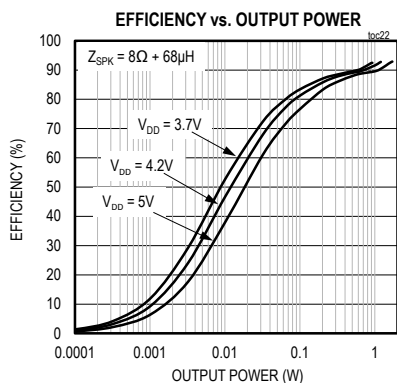
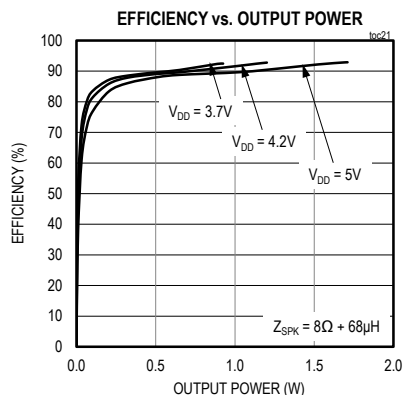
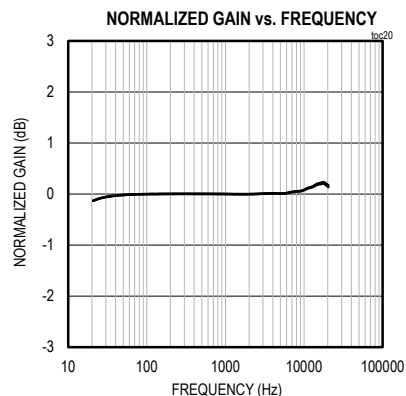
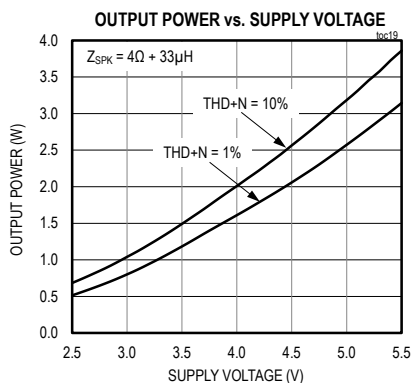
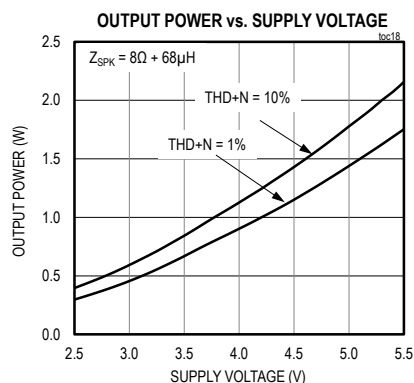

# MAX98357A/MAX98357B

## PCM Input Class D Audio Power Amplifiers

### Typical Operating Characteristics (continued)

( $V_{DD} = 5V$ ,  $V_{GND} = 0V$ , GAIN\_SLOT = GND (+12dB). BCLK = 3.072MHz, LRCLK = 48kHz, speaker loads ( $Z_{SPK}$ ) connected between OUTP and OUTN,  $T_A = T_{MIN}$  to  $T_{MAX}$ , unless otherwise noted. Typical values are at  $T_A = +25^{\circ}C$ .)

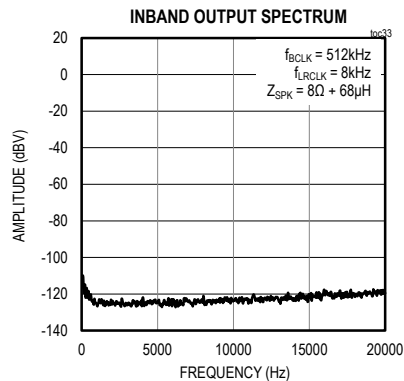
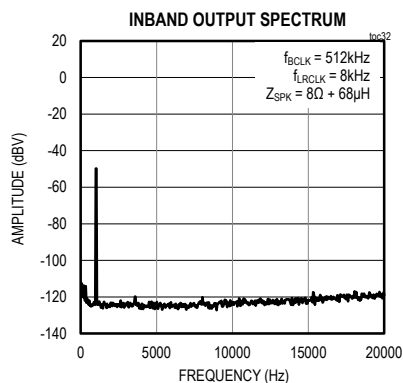
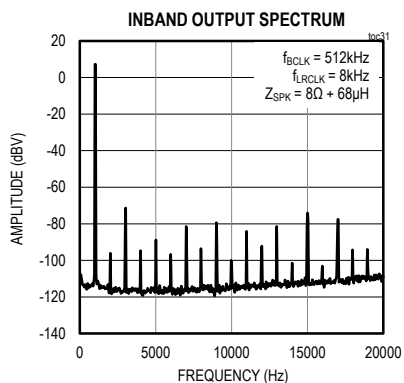
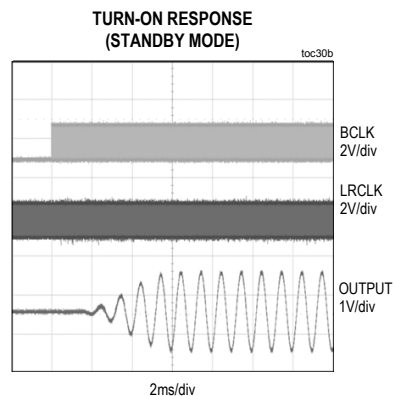
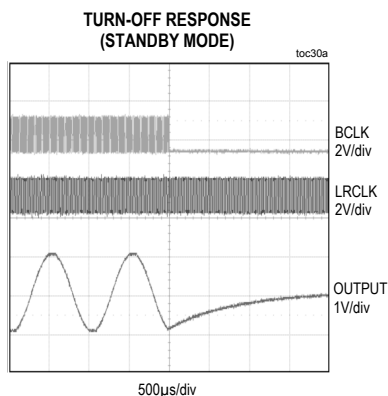
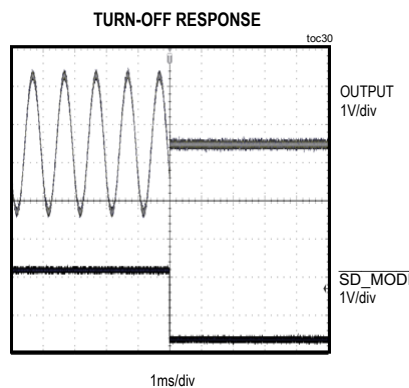
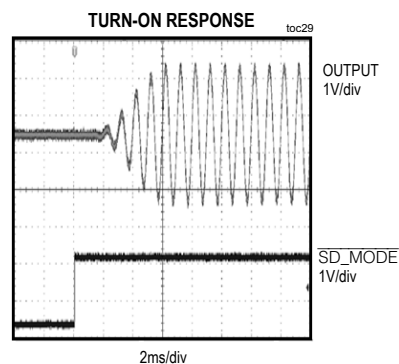
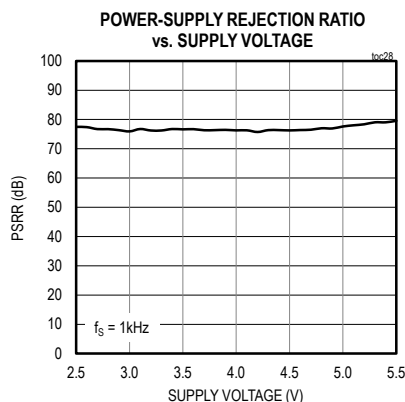
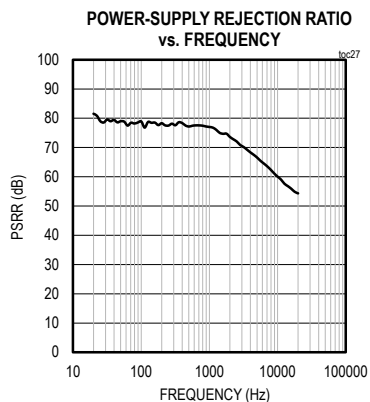

# MAX98357A/MAX98357B

## PCM Input Class D Audio Power Amplifiers

### Typical Operating Characteristics (continued)

( $V_{DD} = 5V$ ,  $V_{GND} = 0V$ , GAIN\_SLOT = GND (+12dB). BCLK = 3.072MHz, LRCLK = 48kHz, speaker loads ( $Z_{SPK}$ ) connected between OUTP and OUTN,  $T_A = T_{MIN}$  to  $T_{MAX}$ , unless otherwise noted. Typical values are at  $T_A = +25^\circ C$ .)

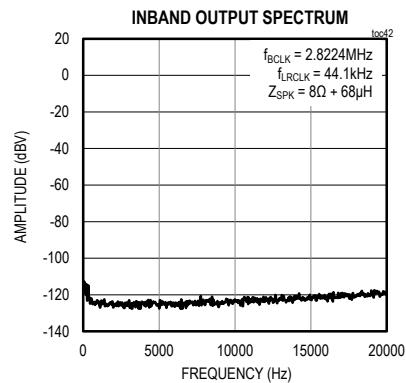
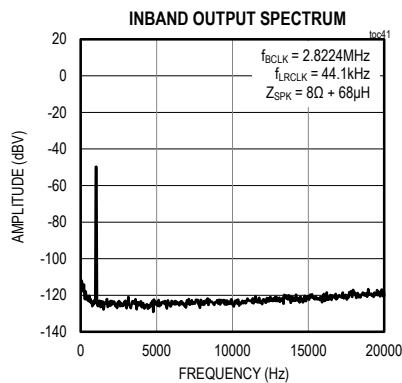
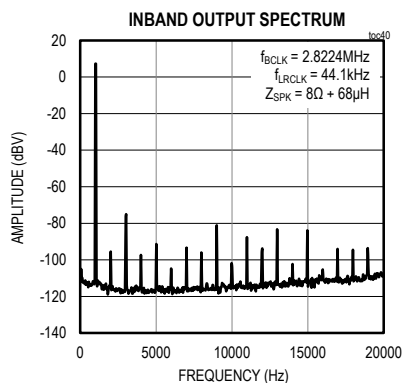
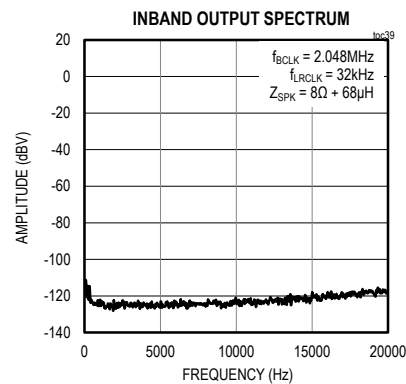
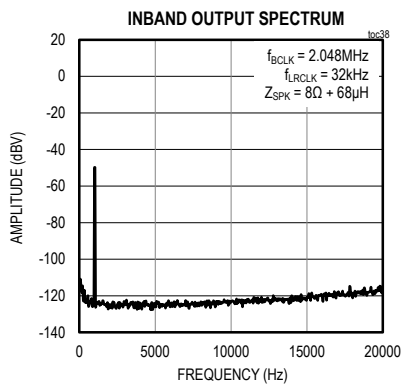
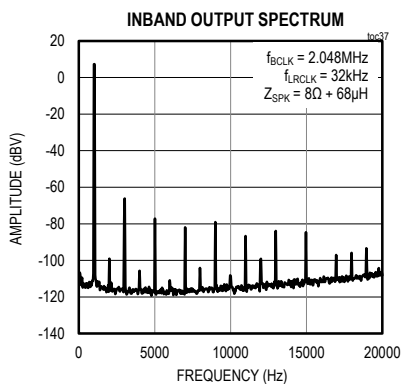
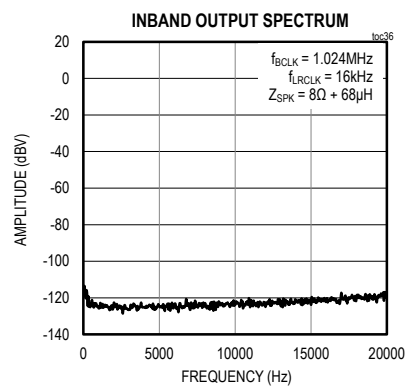
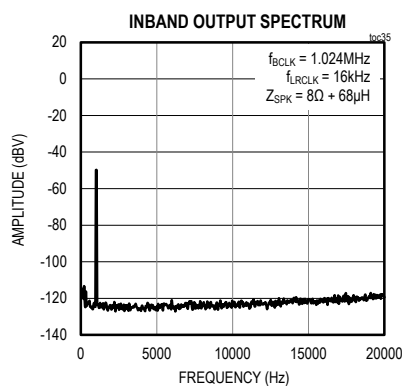
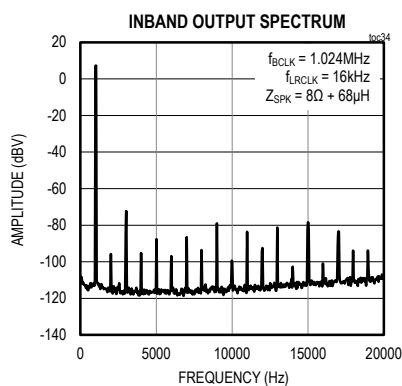

# MAX98357A/MAX98357B

## PCM Input Class D Audio Power Amplifiers

### Typical Operating Characteristics (continued)

( $V_{DD} = 5V$ ,  $V_{GND} = 0V$ , GAIN\_SLOT = GND (+12dB). BCLK = 3.072MHz, LRCLK = 48kHz, speaker loads ( $Z_{SPK}$ ) connected between OUTP and OUTN,  $T_A = T_{MIN}$  to  $T_{MAX}$ , unless otherwise noted. Typical values are at  $T_A = +25^{\circ}C$ .)

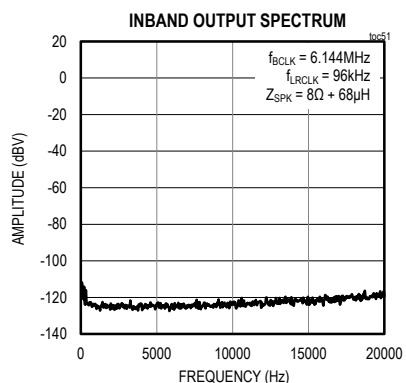
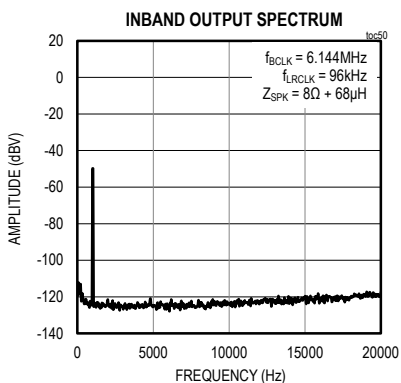
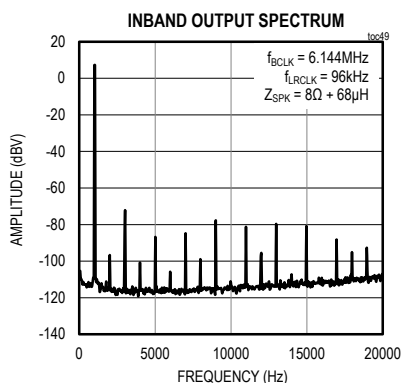
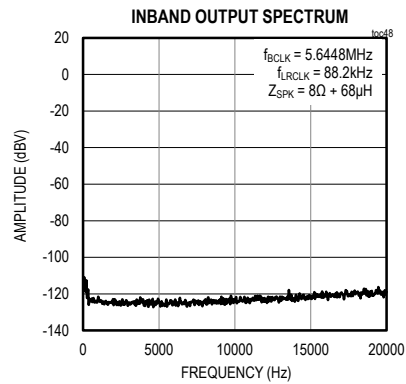
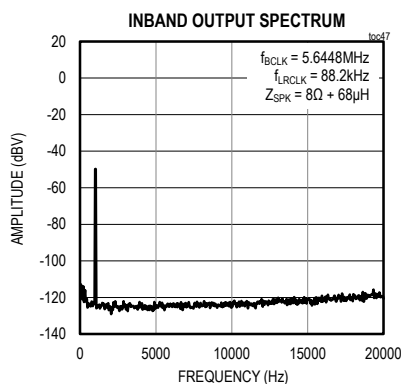
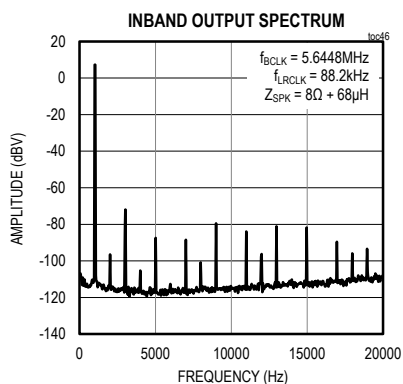
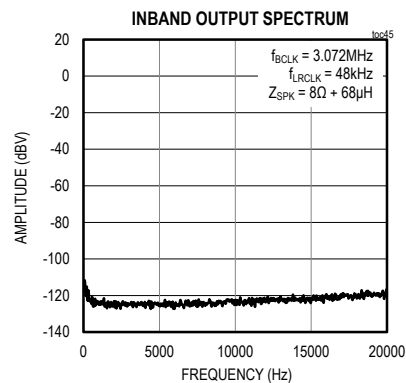
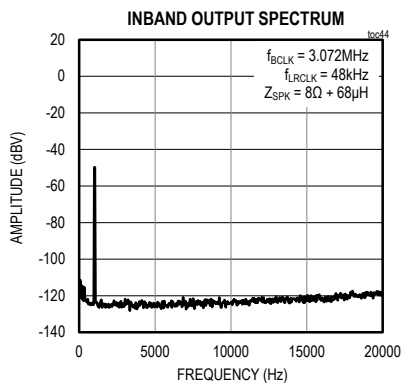
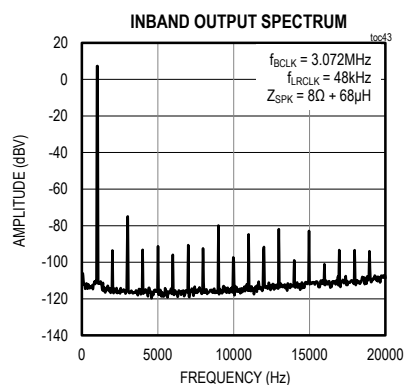

# MAX98357A/MAX98357B

## PCM Input Class D Audio Power Amplifiers

### Pin Configurations

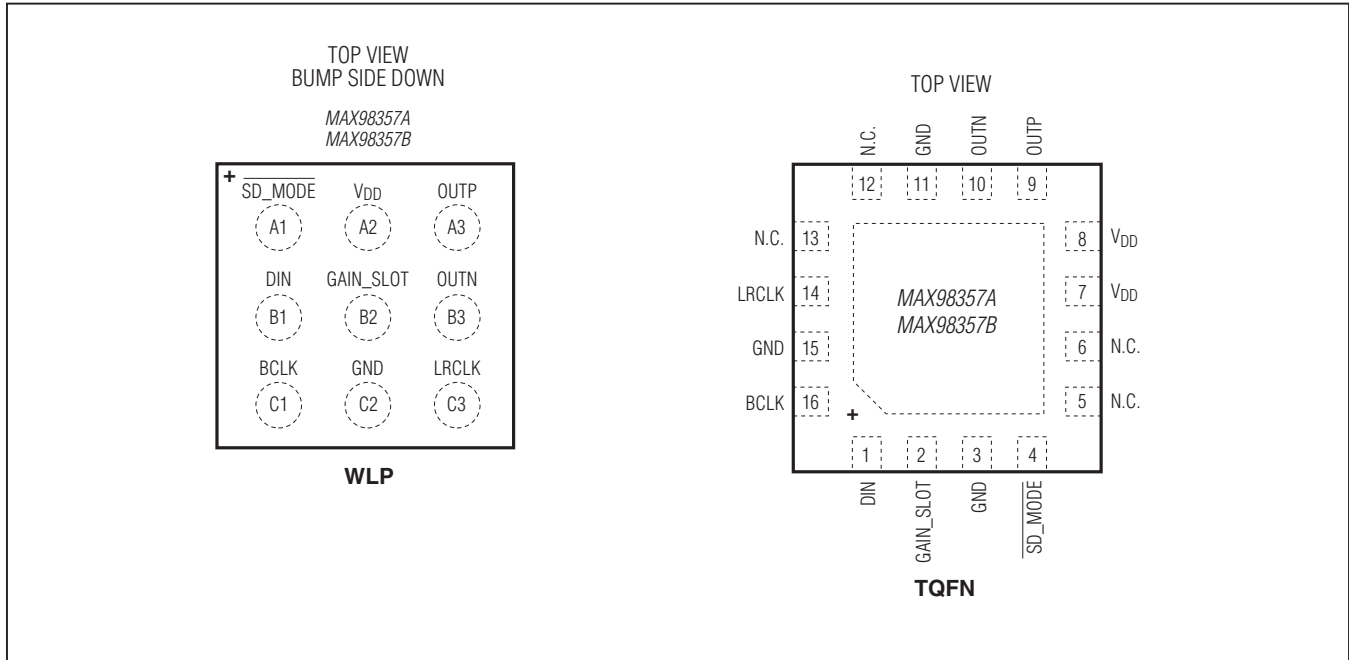

### Pin Description

PIN		NAME	FUNCTION
WLP	TQFN		
A1	4	$\overline{\text{SD\_MODE}}$	Shutdown and Channel Select. Pull $\overline{\text{SD\_MODE}}$ low to place the device in shutdown. In I <sup>2</sup> S or LJ mode, $\overline{\text{SD\_MODE}}$ selects the data channel (Table 5). In TDM mode, $\overline{\text{SD\_MODE}}$ and GAIN_SLOT are both used for channel selection (Table 7).
A2	7, 8	V <sub>DD</sub>	Power-Supply Input
A3	9	OUTP	Positive Speaker Amplifier Output
B1	1	DIN	Digital Input Signal
B2	2	GAIN_SLOT	Gain and Channel Selection. In I <sup>2</sup> S and LJ mode determines amplifier output gain (Table 8) In TDM mode, used for channel selection with SD_MODE (Table 7). In TDM mode, gain is fixed at 12dB.
B3	10	OUTN	Negative Speaker Amplifier Output
C1	16	BCLK	Bit Clock Input
C2	3, 11, 15	GND	Ground
C3	14	LRCLK	Frame Clock. Left/right clock for I <sup>2</sup> S and LJ mode. Sync clock for TDM mode.
—	5, 6, 12, 13	N.C.	No Connection
—	—	EP	Exposed Pad. The exposed pad is not internally connected. Connect the exposed page to a solid ground plane for thermal dissipation.

# MAX98357A/MAX98357B

## PCM Input Class D Audio Power Amplifiers

### Detailed Description

The MAX98357A/MAX98357B are digital PCM input Class D power amplifiers. The MAX98357A accepts standard I<sup>2</sup>S data through DIN, BCLK, and LRCLK while the MAX98357B accepts left-justified data through the same inputs. Both versions also accept 16-bit or 32-bit TDM data with up to eight slots. The digital audio interface eliminates the need for an external MCLK signal that is typically required for I<sup>2</sup>S data transmission.

SD\_MODE selects which data word is output by the amplifier and is used to put the ICs into shutdown. These devices offer five gain settings in I<sup>2</sup>S/left-justified mode and a fixed 12dB gain in TDM mode. Channel selection in TDM mode is set with the combination of SD\_MODE and GAIN\_SLOT (Table 7).

The MAX98357A/MAX98357B feature low-quiescent current, comprehensive click-and-pop suppression, and excellent RF immunity. The ICs offer Class AB audio performance with Class D efficiency in a minimal board-space solution. The Class D amplifier features spread-spectrum modulation with edge-rate and overshoot control circuitry that offers significant improvements in switch-mode amplifier radiated emissions. The amplifier features click-and-pop suppression that reduces audible transients on startup and shutdown. The amplifier includes thermal-overload and short-circuit protection.

### Digital Audio Interface Modes

The input stage of the digital audio interface is highly flexible, supporting 8kHz–96kHz sampling rates with 16/24/32-bit resolution for I<sup>2</sup>S/left justified data as well as up to a 8-slot, 16-bit or 32-bit time division multiplexed (TDM) format. When LRCLK has a 50% duty cycle the data format is determined by the part number selection (MAX98357A/MAX98357B). When a frame sync pulse is used for the LRCLK the data format is automatically configured in TDM mode. The frame sync pulse indicates the beginning of the first time slot.

### MCLK Elimination

The ICs eliminate the need for the external MCLK signal that is typically used for PCM communication. This reduces EMI and possible board coupling issues in addition to reducing the size and pin-count of the ICs.

### BCLK Jitter Tolerance

The ICs feature a BCLK jitter tolerance of 0.5ns for RMS jitter below 40kHz and 12ns for wideband RMS jitter while maintaining a dynamic range greater than 98dB (Table 1).

### BCLK Polarity

When operating in I<sup>2</sup>S/left justified mode, incoming serial data is always clocked-in on the rising edge of BCLK. In TDM mode, the MAX98357A clocks-in serial data on the rising edge of BCLK while the MAX98357B clocks in serial data on the falling edge of BCLK (Table 2).

### LRCLK Polarity

LRCLK specifies whether left-channel data or right-channel data is currently being read by the digital audio interface. The MAX98357A indicates the left channel word when LRCLK is low, and the MAX98357B indicates the left channel word when LRCLK is high (Table 3).

LRCLK ONLY supports 8kHz, 16kHz, 32kHz, 44.1kHz, 48kHz, 88.2kHz and 96kHz frequencies. LRCLK clocks at 11.025kHz, 12kHz, 22.05kHz and 24kHz are **NOT** supported. Do not remove LRCLK while BCLK is present. Removing LRCLK while BCLK is present can cause unexpected output behavior including a large DC output voltage.

### Standby Mode

The ICs automatically enter standby mode when BCLK is removed. If BCLK stops toggling, the ICs automati-

Table 1. RMS Jitter Tolerance

FREQUENCY	RMS JITTER TOLERANCE (ns)
< 40kHz	0.5
40kHz–BCLK	12

Table 2. BCLK Polarity

MODE	PART NUMBER	BCLK POLARITY
I <sup>2</sup> S	MAX98357A	Rising edge
Left-justified	MAX98357B	Rising edge
TDM	MAX98357A	Rising edge
	MAX98357B	Falling edge

Table 3. LRCLK Polarity

PART NUMBER	LRCLK POLARITY (LEFT CHANNEL)
MAX98357A	Low
MAX98357B	High



# MAX98357A/MAX98357B

## PCM Input Class D Audio Power Amplifiers

cally enter standby mode. In standby mode, the Class D speaker is turned off and the outputs go into a high-impedance state, ensuring that unwanted current is not transferred to the load during this condition. Standby mode has reduced power consumption from normal operation (340µA), but does not reach as low as full shutdown (0.6µA). Standby mode can be used to reduce power consumption when no GPIO is available to pull  $\overline{\text{SD\_MODE}}$  low.

### DAC Digital Filters

The DAC features a digital lowpass filter that is automatically configured for voice playback or music playback based on the sample rate that is used. This filter eliminates the effect of aliasing and any other high-frequency noise that might otherwise be present. Table 4 shows the digital filter settings that are automatically selected.

### SD\_MODE and Shutdown Operation

The ICs feature a low-power shutdown mode, drawing less than 0.6µA (typ) of supply current. During shutdown, all internal blocks are turned off, including setting the output stage to a high-impedance state. Drive  $\overline{\text{SD\_MODE}}$  low to put the ICs into shutdown.

The state of  $\overline{\text{SD\_MODE}}$  determines the audio channel that is sent to the amplifier output (Table 5).

Drive  $\overline{\text{SD\_MODE}}$  high to select the left word of the stereo input data. Drive  $\overline{\text{SD\_MODE}}$  high through a sufficiently small resistor to select the right word of the stereo input data. Drive  $\overline{\text{SD\_MODE}}$  high through a sufficiently large resistor to select both the left and right words of the stereo input data (left/2 + right/2).  $R_{\text{LARGE}}$  and  $R_{\text{SMALL}}$  are determined by the  $V_{\text{DDIO}}$  voltage (logic voltage from control interface) that is driving  $\overline{\text{SD\_MODE}}$  according to the following two equations:

$$R_{\text{SMALL}} (\text{k}\Omega) = 94.0 \times V_{\text{DDIO}} - 100$$

$$R_{\text{LARGE}} (\text{k}\Omega) = 222.2 \times V_{\text{DDIO}} - 100$$

When the devices are configured in left-channel mode ( $\overline{\text{SD\_MODE}}$  is directly driven to logic-high by the control interface), take care to avoid violating the Absolute Maximum Ratings limits for  $\overline{\text{SD\_MODE}}$ . Ensuring that  $V_{\text{DD}}$  is always greater than  $V_{\text{DDIO}}$  is one way to prevent  $\overline{\text{SD\_MODE}}$  from violating the Absolute Maximum Ratings limits. If this is not possible in the application (e.g., if  $V_{\text{DD}} < 3.0\text{V}$  and  $V_{\text{DDIO}} = 3.3\text{V}$ ), then it is necessary to add a small resistance (~2kΩ) in series with  $\overline{\text{SD\_MODE}}$  to limit the current into the  $\overline{\text{SD\_MODE}}$  pin. This is not a concern when using the right channel or (left/2 + right/2) modes.

Figure 4 and Figure 5 show how to connect an external resistor to  $\overline{\text{SD\_MODE}}$  when using an open-drain driver or a push-pull driver.

**Table 4. Digital Filter Settings**

LRCLK FREQUENCY	-3dB CUTOFF FREQUENCY	RIPPLE LIMIT CUTOFF FREQUENCY	STOPBAND CUTOFF FREQUENCY	STOPBAND ATTENUATION (dB)
$f_{\text{LRCLK}} < 30\text{kHz}$	$0.446 \times f_{\text{LRCLK}}$	$0.443 \times f_{\text{LRCLK}}$	$0.464 \times f_{\text{LRCLK}}$	75
$30\text{kHz} < f_{\text{LRCLK}} < 50\text{kHz}$	$0.47 \times f_{\text{LRCLK}}$	$0.43 \times f_{\text{LRCLK}}$	$0.58 \times f_{\text{LRCLK}}$	60
$f_{\text{LRCLK}} > 50\text{kHz}$	$0.31 \times f_{\text{LRCLK}}$	$0.24 \times f_{\text{LRCLK}}$	$0.477 \times f_{\text{LRCLK}}$	60

**Table 5. SD\_MODE Control**

SD_MODE STATUS		SELECTED CHANNEL
High	$V_{\overline{\text{SD\_MODE}}} > \text{B2 trip point}$	Left
Pullup through $R_{\text{SMALL}}$	$\text{B2 trip point} > V_{\overline{\text{SD\_MODE}}} > \text{B1 trip point}$	Right
Pullup through $R_{\text{LARGE}}$	$\text{B1 trip point} > V_{\overline{\text{SD\_MODE}}} > \text{B0 trip point}$	(Left/2 + right/2)
Low	$\text{B0 trip point} > V_{\overline{\text{SD\_MODE}}}$	Shutdown

**Table 6. Examples of SD\_MODE Pullup Resistor Values**

LOGIC VOLTAGE LEVEL ( $V_{\text{DDIO}}$ ) (V)	$R_{\text{SMALL}}$ (kΩ)	$R_{\text{LARGE}}$ (kΩ)
1.8	69.8	300
3.3	210.2	634

# MAX98357A/MAX98357B

## PCM Input Class D Audio Power Amplifiers

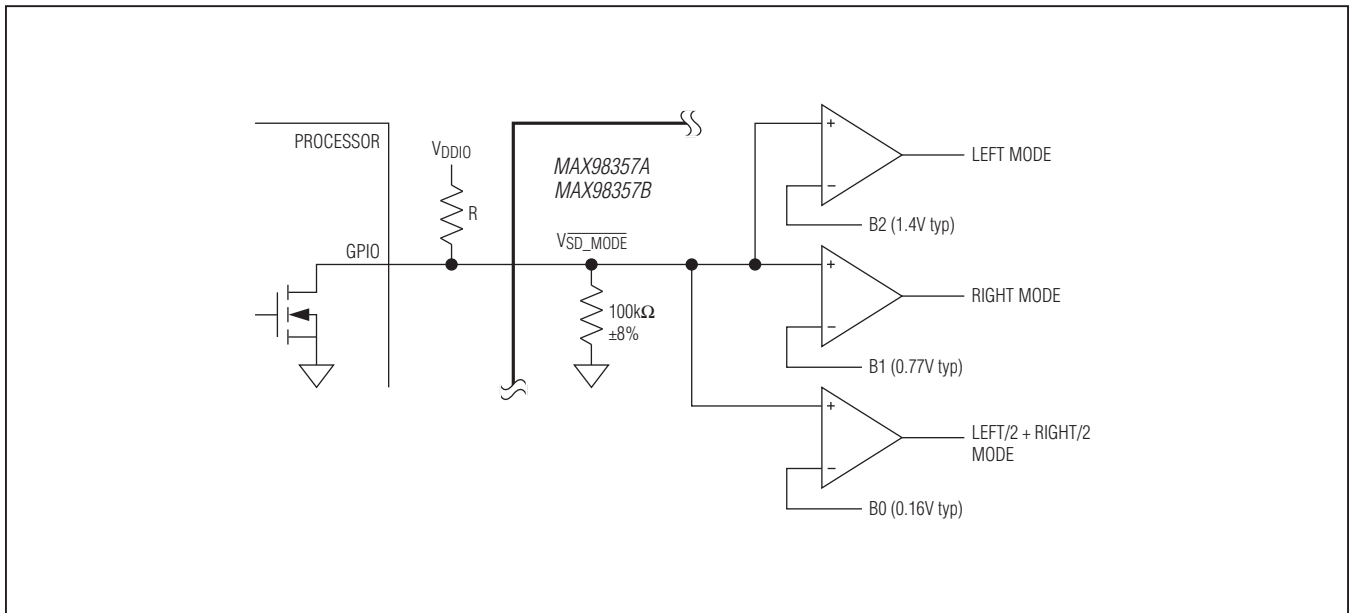

Figure 4. SD\_MODE Resistor Connected Using Open-Drain Driver

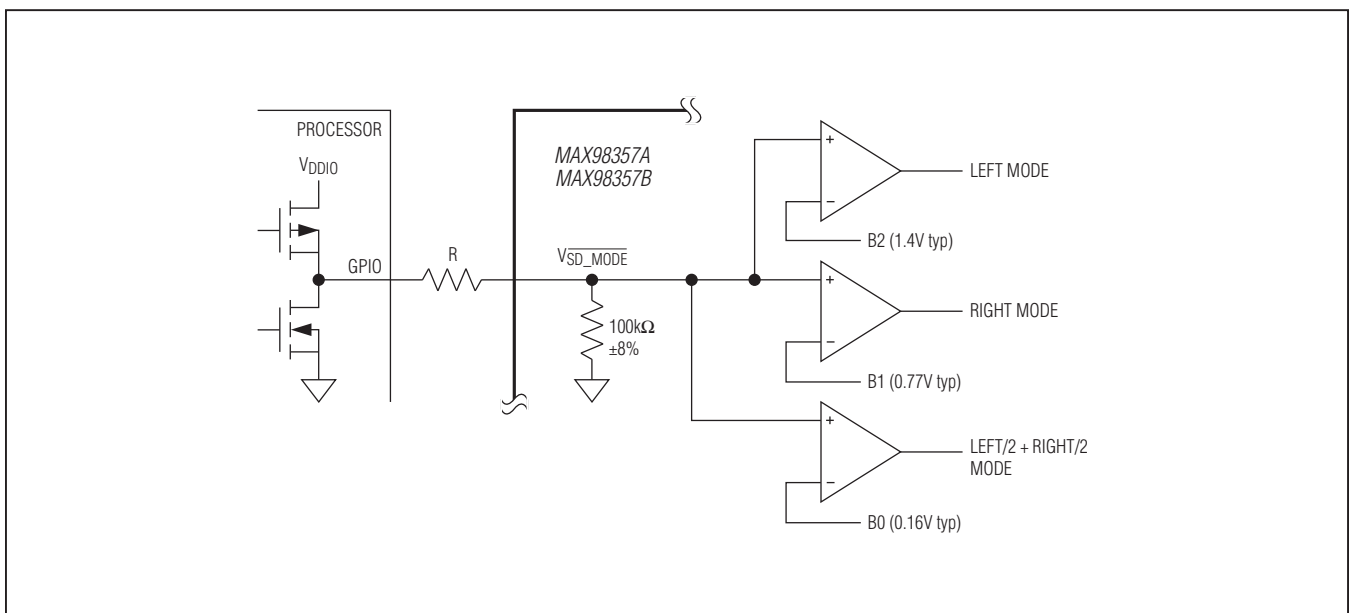

Figure 5. SD\_MODE Resistor Connected Using Push-Pull Driver

# MAX98357A/MAX98357B

## PCM Input Class D Audio Power Amplifiers

### I<sup>2</sup>S and Left Justified Mode

The MAX98357A follows standard I<sup>2</sup>S timing by allowing a delay of one BCLK cycle after the LRCLK transition before the beginning of a new data word (Figure 6 and Figure 7). The MAX98357B follows the left justified timing specification by aligning the LRCLK transitions with the beginning of a new data word (Figure 8 and Figure 9). LRCLK ONLY supports 8kHz, 16kHz, 32kHz, 44.1kHz, 48kHz, 88.2kHz, and 96kHz frequencies. LRCLK clocks at 11.025kHz, 12kHz, 22.05kHz and 24kHz are **NOT** supported. Do not remove LRCLK while BCLK is present. Removing LRCLK while BCLK is present can cause unexpected output behavior, including a large DC output voltage.

The digital audio interface output mode is chosen by the voltage at  $\overline{\text{SD\_MODE}}$ . Table 5 shows how the available modes are selected. Trip point B0–B2 are shown the Electrical Characteristics in the  $\overline{\text{SD\_MODE}}$  Comparator Trip Points section. Values for  $\overline{\text{SD\_MODE}}$  pullup resistors

$R_{\text{SMALL}}$  and  $R_{\text{LARGE}}$  are dependent on the voltage level of  $V_{\text{DDIO}}$ . See Table 6 for pullup resistor values.

### TDM Mode

TDM mode is automatically detected by monitoring the short channel sync pulse on LRCLK. The frequency detector circuit detects the bit depth. In TDM mode, the MAX98357A/MAX98357B has a fixed gain of 12dB.  $\text{GAIN\_SLOT}$  and  $\overline{\text{SD\_MODE}}$  are used to select to which of 8 channels of TDM data the parts respond. Table 7 shows the connections for  $\text{GAIN\_SLOT}$  and  $\overline{\text{SD\_MODE}}$  for channel selection. The MAX98357A data is valid on the BCLK rising edge. The MAX98357B data is valid on the BCLK falling edge.

Figure 10, Figure 11, Figure 12, and Figure 13 show TDM operation, in which a frame-sync pulse is used for LRCLK. In TDM mode, there must be 128 (16-bit mode) or 256 (32-bit mode) BCLK cycles per frame. In TDM mode, the ICs only accept 16-bit or 32-bit formatted data and any of the 8 TDM slots can be selected.

**Table 7. TDM Mode Channel Selection**

$\overline{\text{SD\_MODE}}$	$\text{GAIN\_SLOT}$	CHANNEL	BITS
Low	X	Off	N/A
$V_{\text{DD}}$	GND	0	16/32
$V_{\text{DD}}$	$V_{\text{DD}}$ with $0\Omega$	1	16/32
$V_{\text{DD}}$	Float	2	16/32
$V_{\text{DD}}$	$V_{\text{DD}}$ with $100\text{k}\Omega$	3	16/32
$V_{\text{DD}}$	GND with $100\text{k}\Omega$	4	16/32
$V_{\text{DD}}$ through $R_{\text{LARGE}}$	GND	5	16/32
$V_{\text{DD}}$ through $R_{\text{LARGE}}$	Float	6	16/32
$V_{\text{DD}}$ through $R_{\text{LARGE}}$	$V_{\text{DD}}$	7	16/32

# MAX98357A/MAX98357B

## PCM Input Class D Audio Power Amplifiers

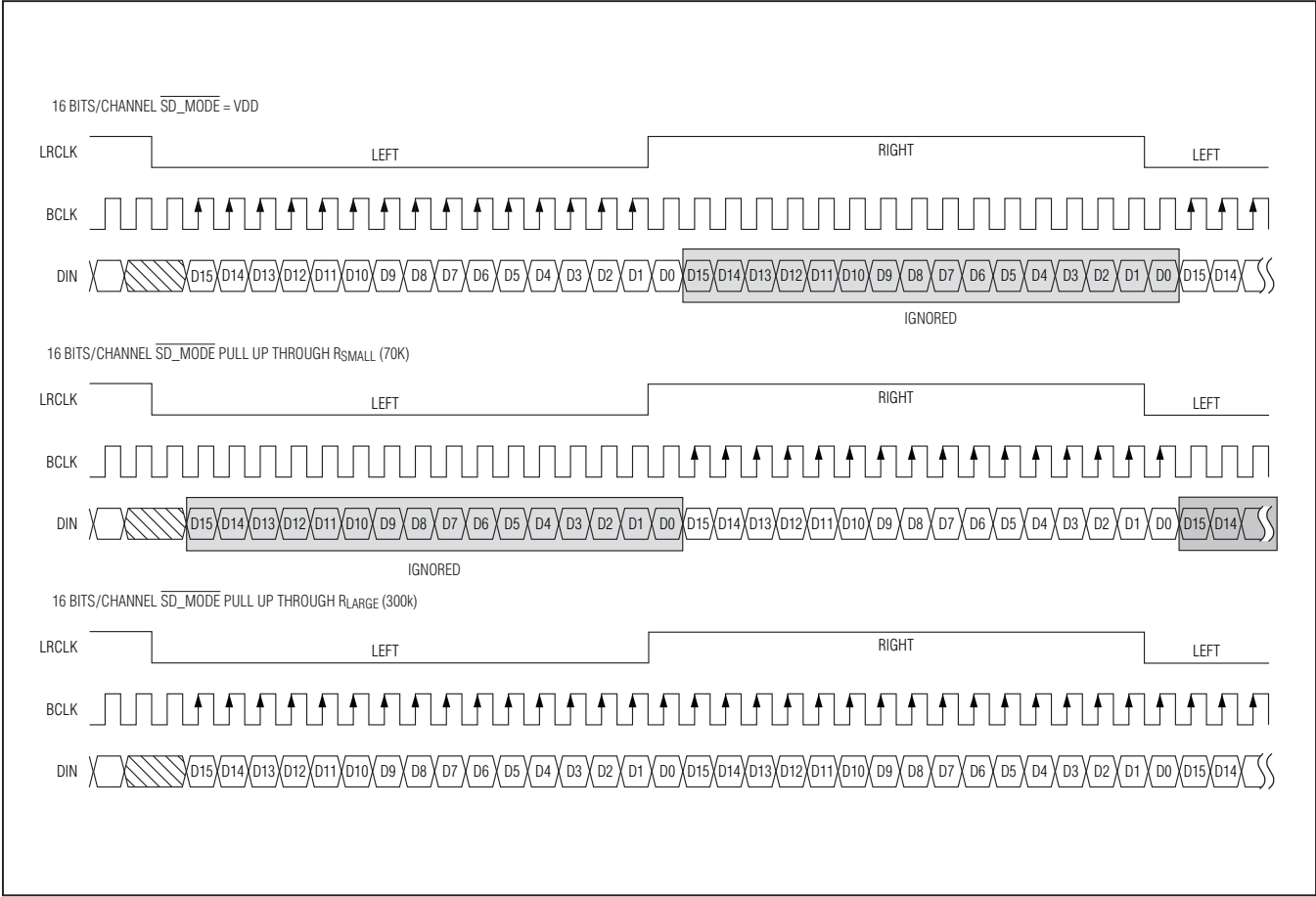

Figure 6. MAX98357A I<sup>2</sup>S Digital Audio Interface Timing, 16-Bit Resolution

# MAX98357A/MAX98357B

## PCM Input Class D Audio Power Amplifiers

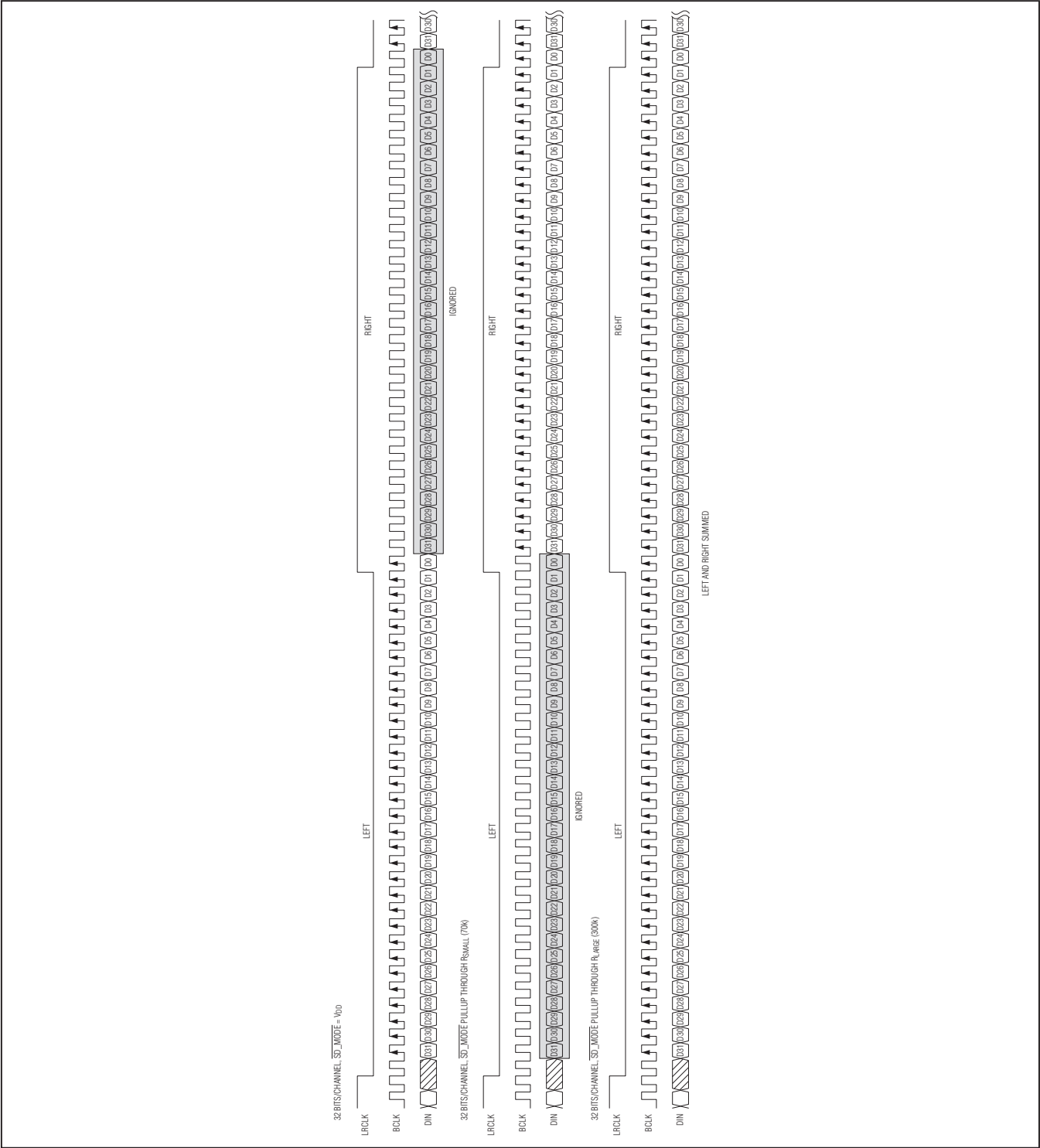

Figure 7. MAX98357A I<sup>2</sup>S Digital Audio Interface Timing, 32-Bit Resolution

# MAX98357A/MAX98357B

## PCM Input Class D Audio Power Amplifiers

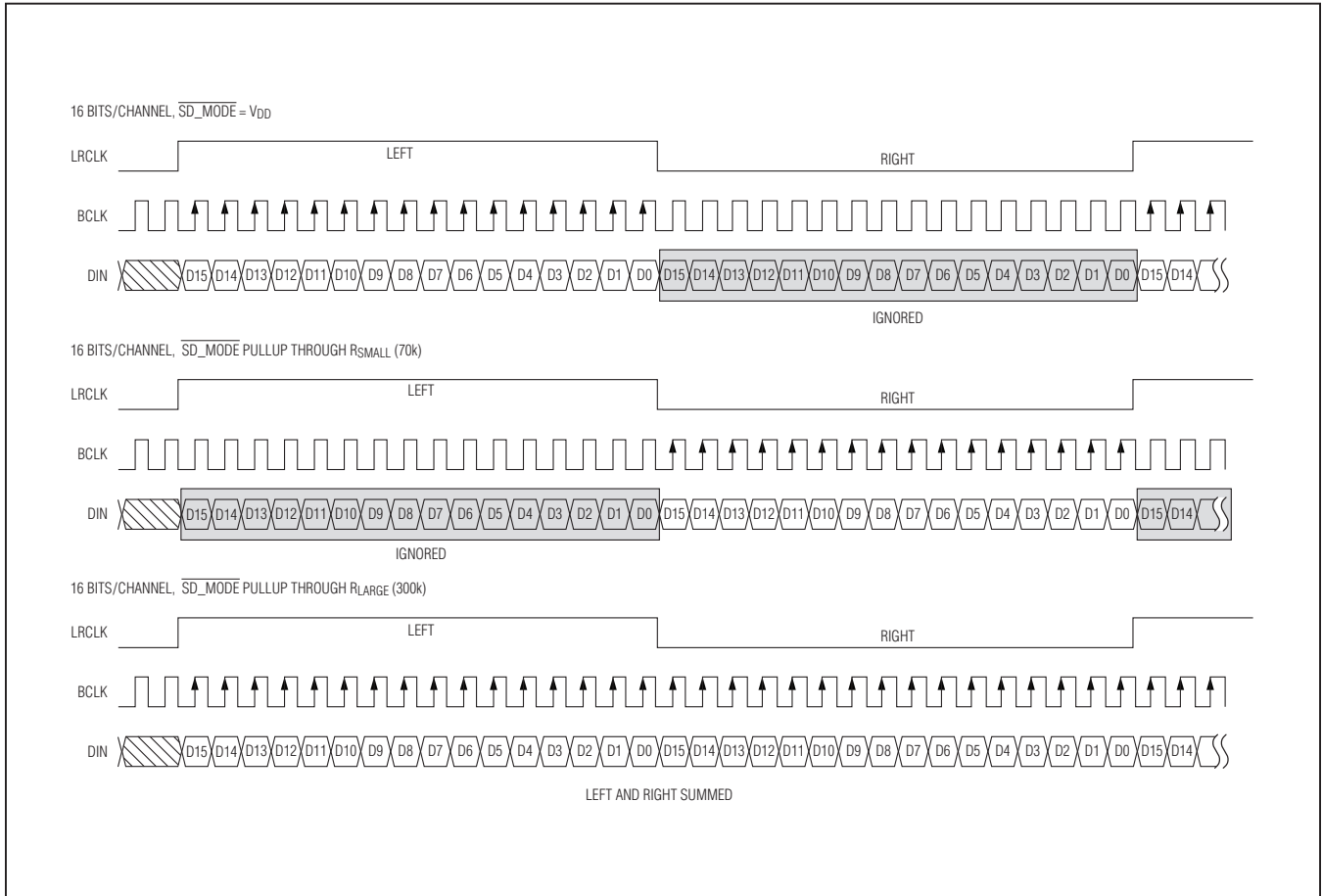

Figure 8. MAX98357B Left-Justified Digital Audio Interface Timing, 16-Bit Resolution

# MAX98357A/MAX98357B

## PCM Input Class D Audio Power Amplifiers

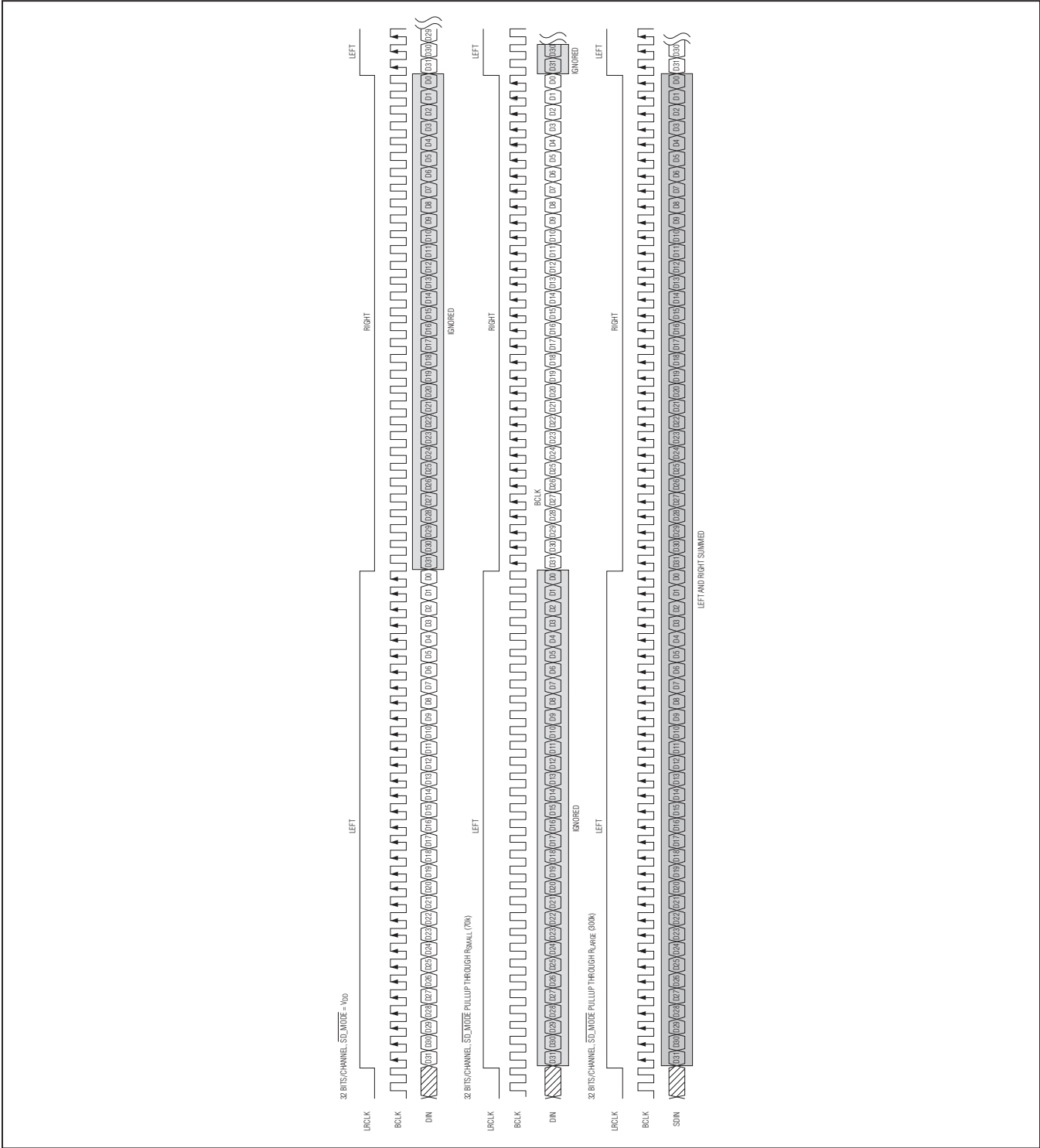

Figure 9. MAX98357B Left-Justified Digital Audio Interface Timing, 32-Bit Resolution

# MAX98357A/MAX98357B

## PCM Input Class D Audio Power Amplifiers

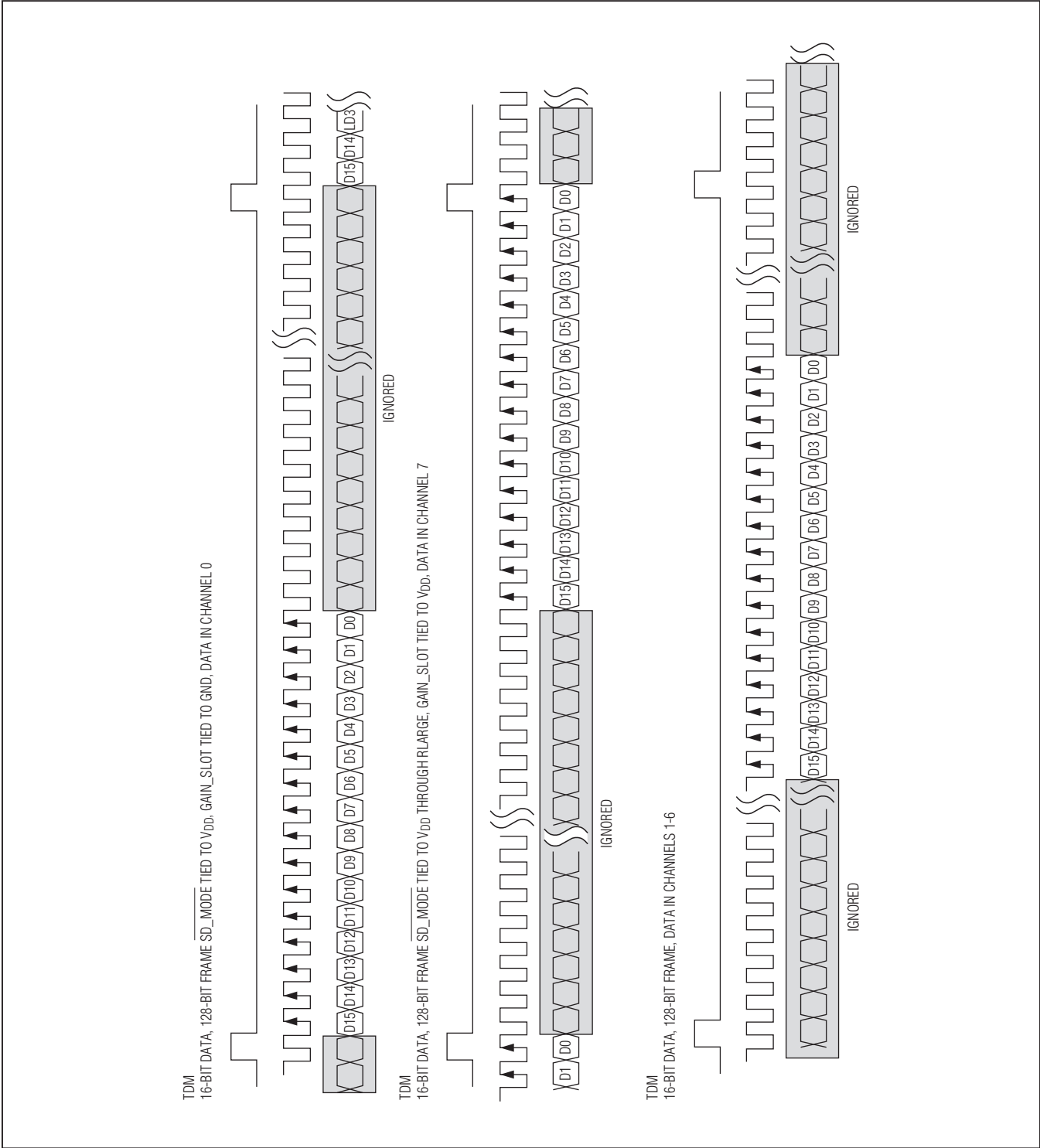

Figure 10. MAX98357A TDM 16-Bit DAI Timing



# MAX98357A/MAX98357B

## PCM Input Class D Audio Power Amplifiers

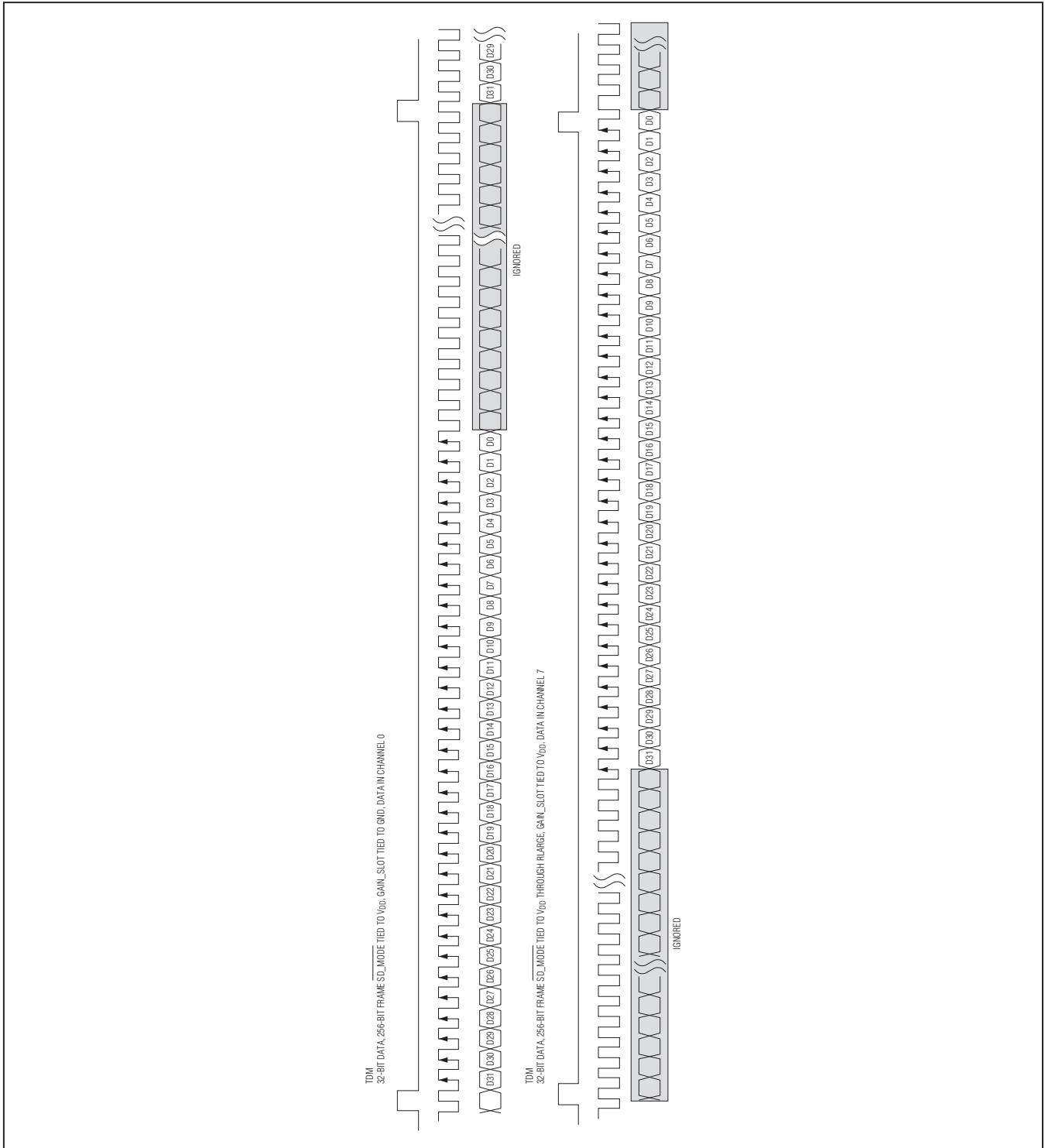

Figure 11. MAX98357A TDM 32-Bit DAI Timing

# MAX98357A/MAX98357B

## PCM Input Class D Audio Power Amplifiers

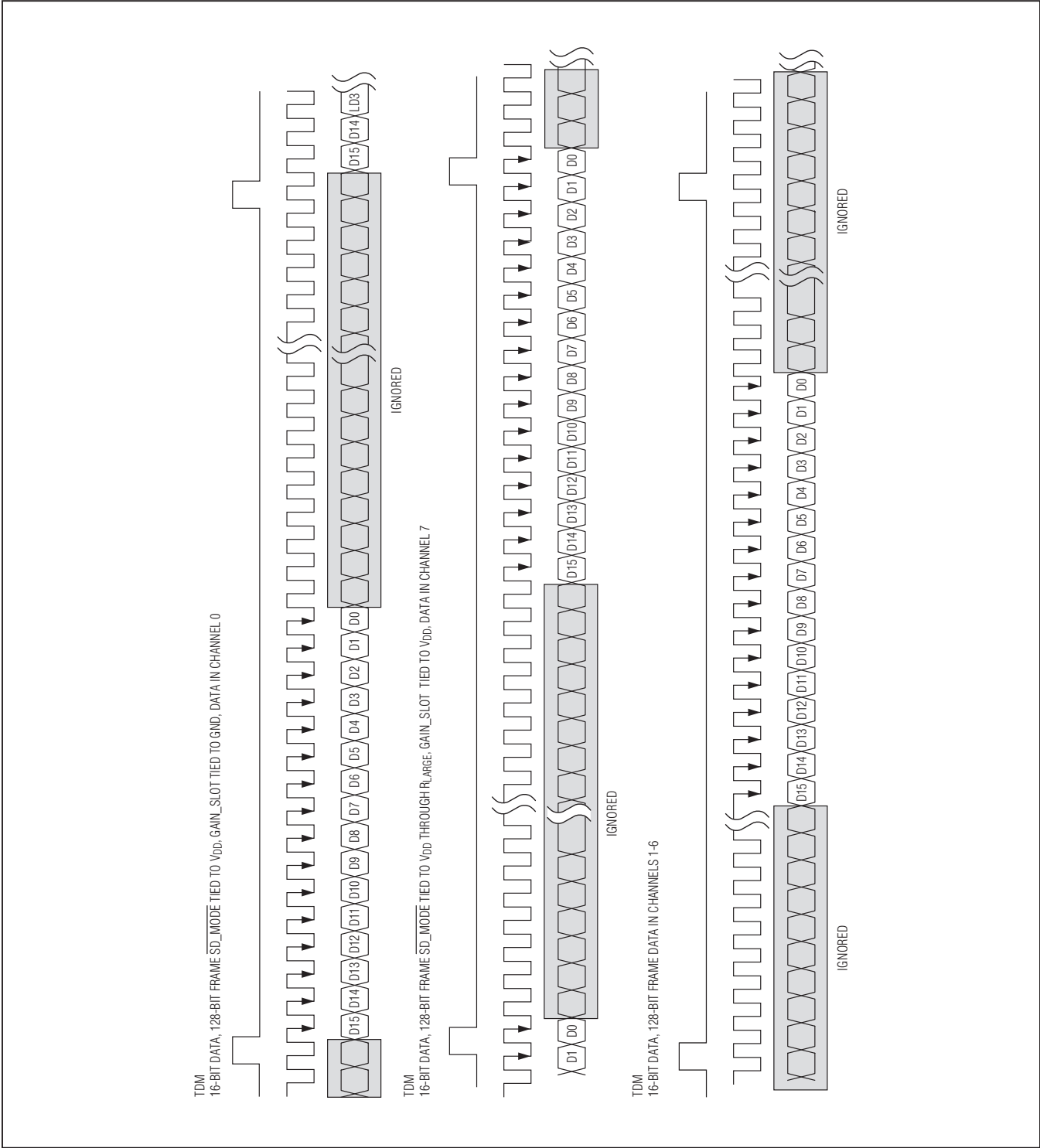

Figure 12. MAX98357B TDM 16-Bit DAI Timing

# MAX98357A/MAX98357B

## PCM Input Class D Audio Power Amplifiers

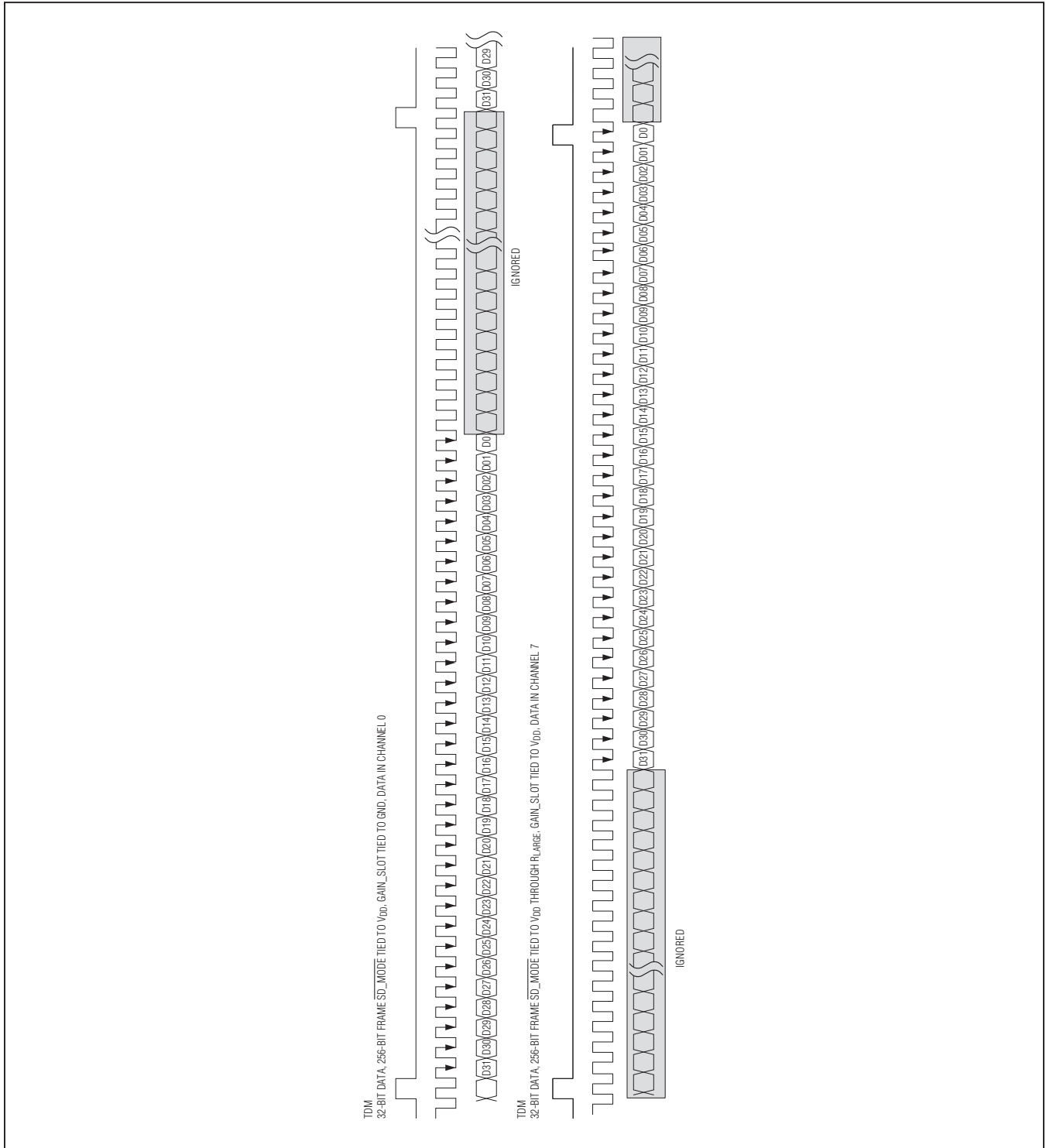

Figure 13. MAX98357B TDM 32-Bit DAI Timing

# MAX98357A/MAX98357B

## PCM Input Class D Audio Power Amplifiers

### Class D Speaker Amplifier

The filterless Class D amplifier offers much higher efficiency than Class AB amplifiers. The high efficiency of a Class D amplifier is due to the switching operation of the output stage transistors. Any power loss associated with the Class D output stage is mostly due to the I<sup>2</sup>R loss of the MOSFET on-resistance and quiescent current overhead.

### Ultra-Low EMI Filterless Output Stage

Traditional Class D amplifiers require the use of external LC filters, or shielding, to meet EN55022B electromagnetic-interference (EMI) regulation standards. Maxim's active emissions-limiting edge-rate control circuitry and spread-spectrum modulation reduces EMI emissions while maintaining up to 92% efficiency.

Maxim's spread-spectrum modulation mode flattens wideband spectral components while proprietary techniques ensure that the cycle-to-cycle variation of the switching period does not degrade audio reproduction or efficiency. The ICs' spread-spectrum modulator randomly varies the switching frequency by ±20kHz around the center frequency (330kHz). Above 10MHz, the wideband spectrum looks like noise for EMI purposes (Figure 14).

### Speaker Current Limit

If the output current of the speaker amplifier exceeds the current limit (2.8A typ), the IC disables the outputs for approximately 100µs. At the end of the 100µs, the outputs are re-enabled. If the fault condition still exists, the IC continues to disable and reenable the outputs until the fault condition is removed.

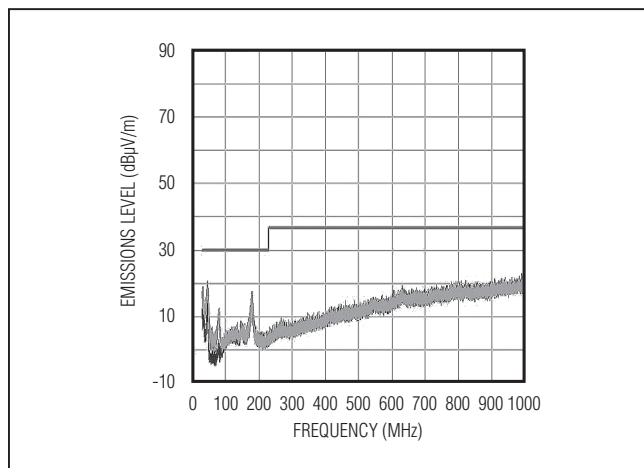

Figure 14. EMI with 12in of Speaker Cable and No Output Filtering

### Gain Selection

The ICs offer five programmable gain selections through a single gain input (GAIN\_SLOT) in I<sup>2</sup>S/left justified mode. Gain is referenced to the full-scale output of the DAC, which is 2.1dBV (Table 8). In TDM mode, the gain is automatically set at a fixed 12dB. Assuming that the desired output swing is not limited by the supply voltage rail, the IC's output level can be calculated based on the digital input signal level and selected amplifier gain according to the following equation:

$$\text{Output signal level (dBV)} = \text{input signal level (dBFS)} + 2.1\text{dB} + \text{selected amplifier gain (dB)}$$

where 0dBFS is referenced to 0dBV.

### Click-and-Pop Suppression

The IC speaker amplifier features Maxim's comprehensive click-and-pop suppression. During startup, the click-and-pop suppression circuitry reduces audible transient sources internal to the device by ramping the input signal from mute to 0dB. When entering shutdown, the differential speaker outputs simultaneously drop to GND.

The comprehensive click-and-pop suppression of the MAX98357 is unaffected by power-up or power-down sequencing. Applying the DAI clocks before or after the transition of SD\_MODE yields the same click-and-pop performance. The MAX98357 does not have a volume ramp-down response when entering shutdown. For optimal click-and-pop performance, ramp down the digital data on SDIN before powering down the MAX98357.

Table 8. Gain Selection

GAIN_SLOT	I <sup>2</sup> S/LJ GAIN (dB)
Connect to GND through 100kΩ ±5% resistor	15
Connect to GND	12
Unconnected	9
Connect to V <sub>DD</sub>	6
Connect to V <sub>DD</sub> through 100kΩ ±5% resistor	3

# MAX98357A/MAX98357B

## PCM Input Class D Audio Power Amplifiers

### Applications Information

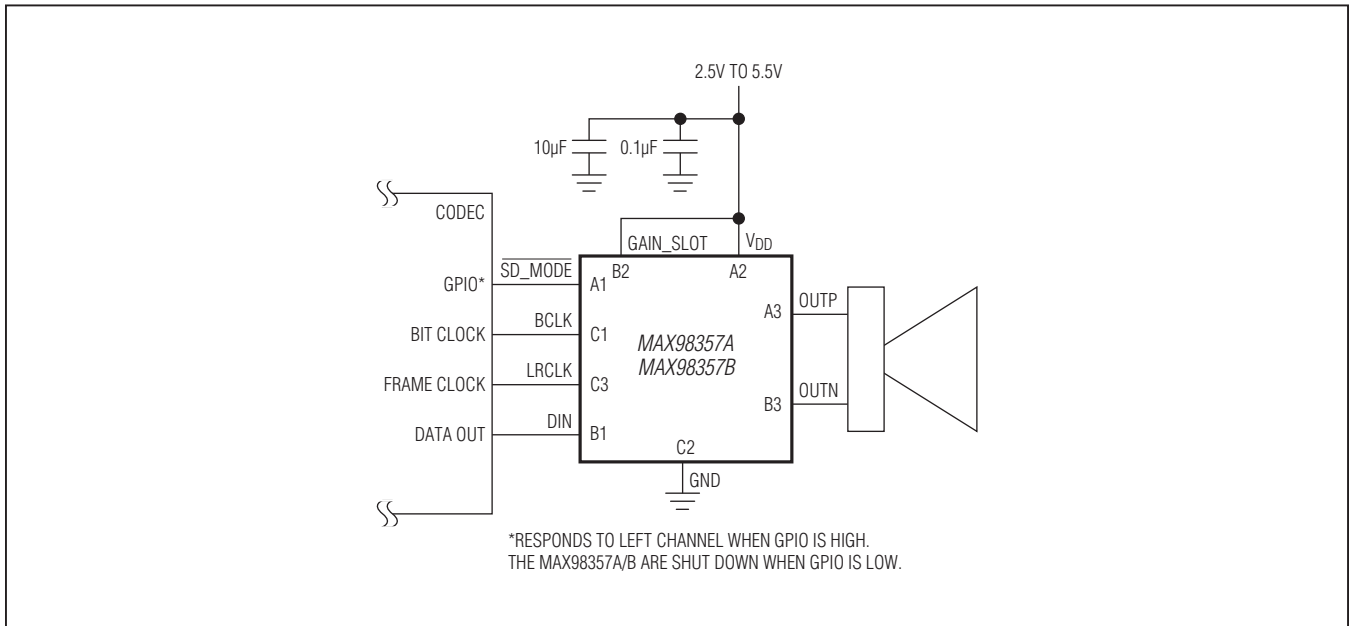

Figure 15. Left-Channel PCM Operation with 6dB Gain

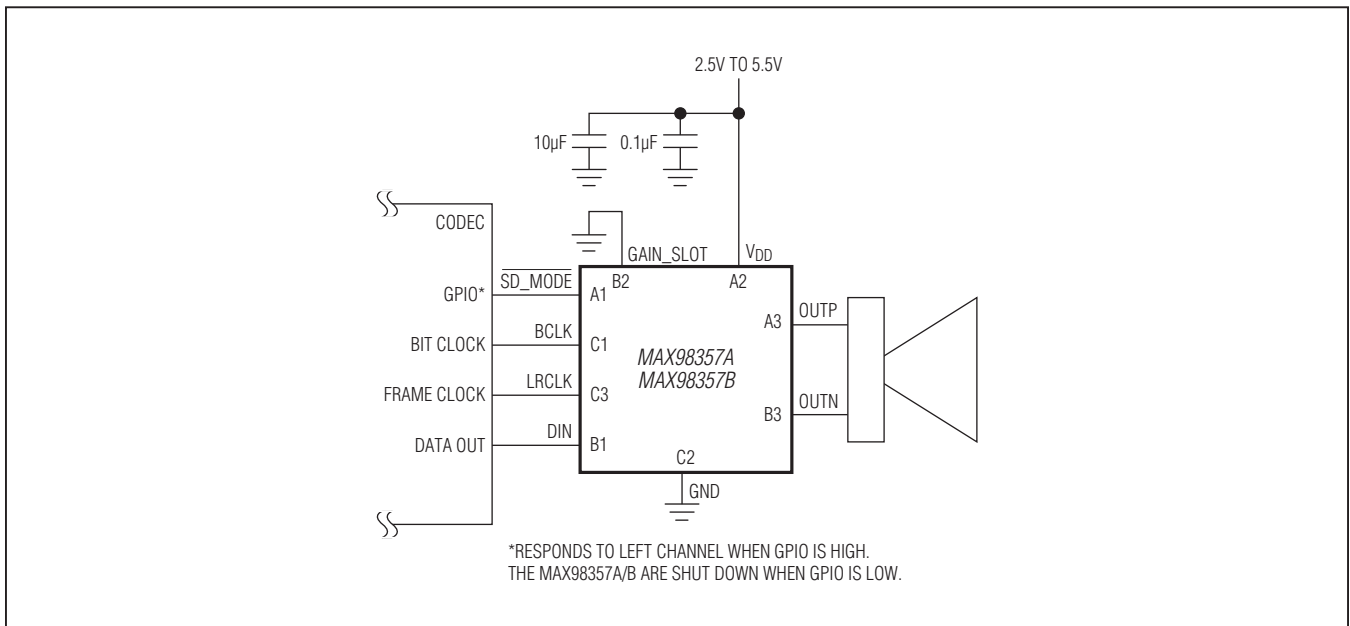

Figure 16. Left-Channel PCM Operation with 12dB Gain

# MAX98357A/MAX98357B

## PCM Input Class D Audio Power Amplifiers

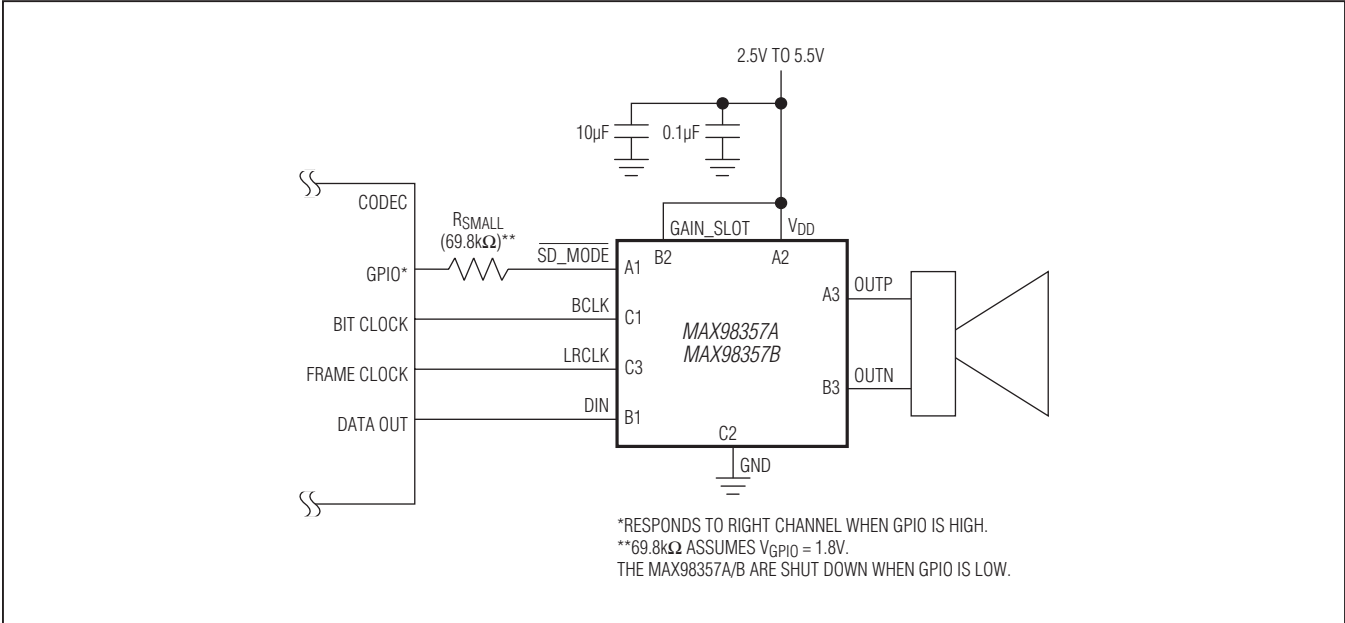

Figure 17. Right-Channel PCM Operation with 6dB Gain

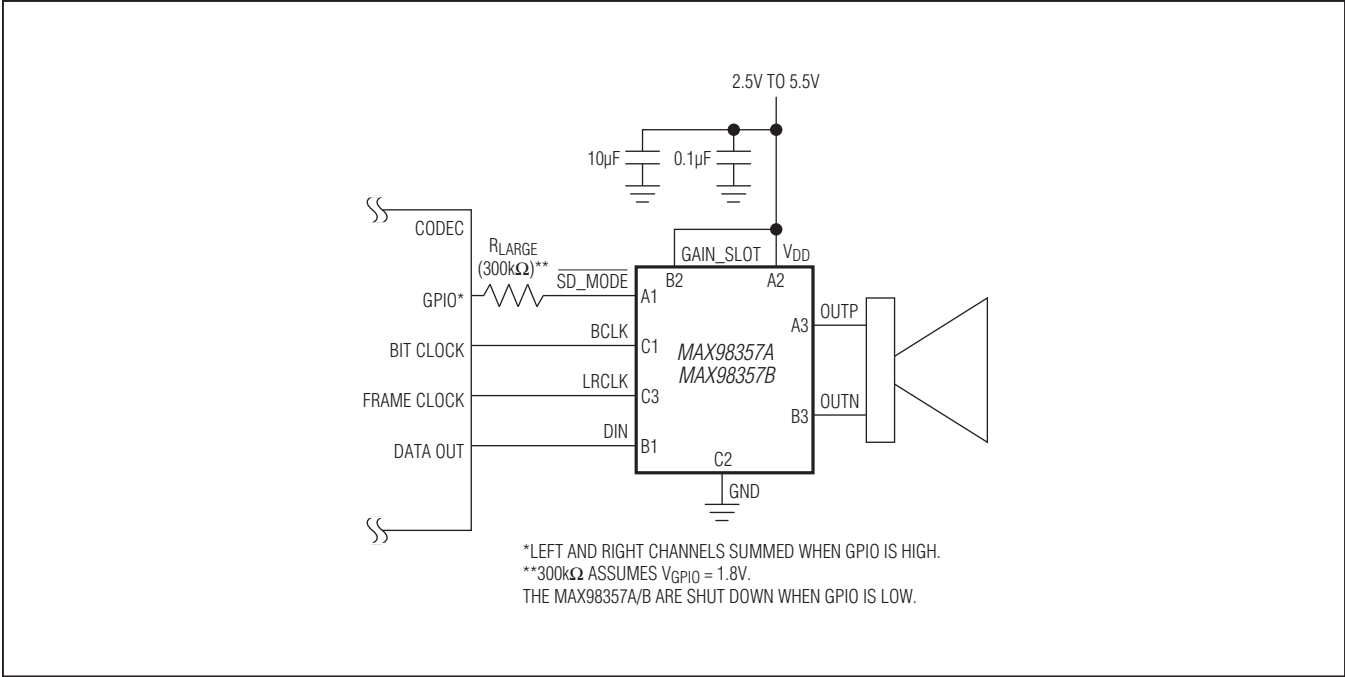

Figure 18. (Left/2 + Right/2) PCM Operation with 6dB Gain

# MAX98357A/MAX98357B

## PCM Input Class D Audio Power Amplifiers

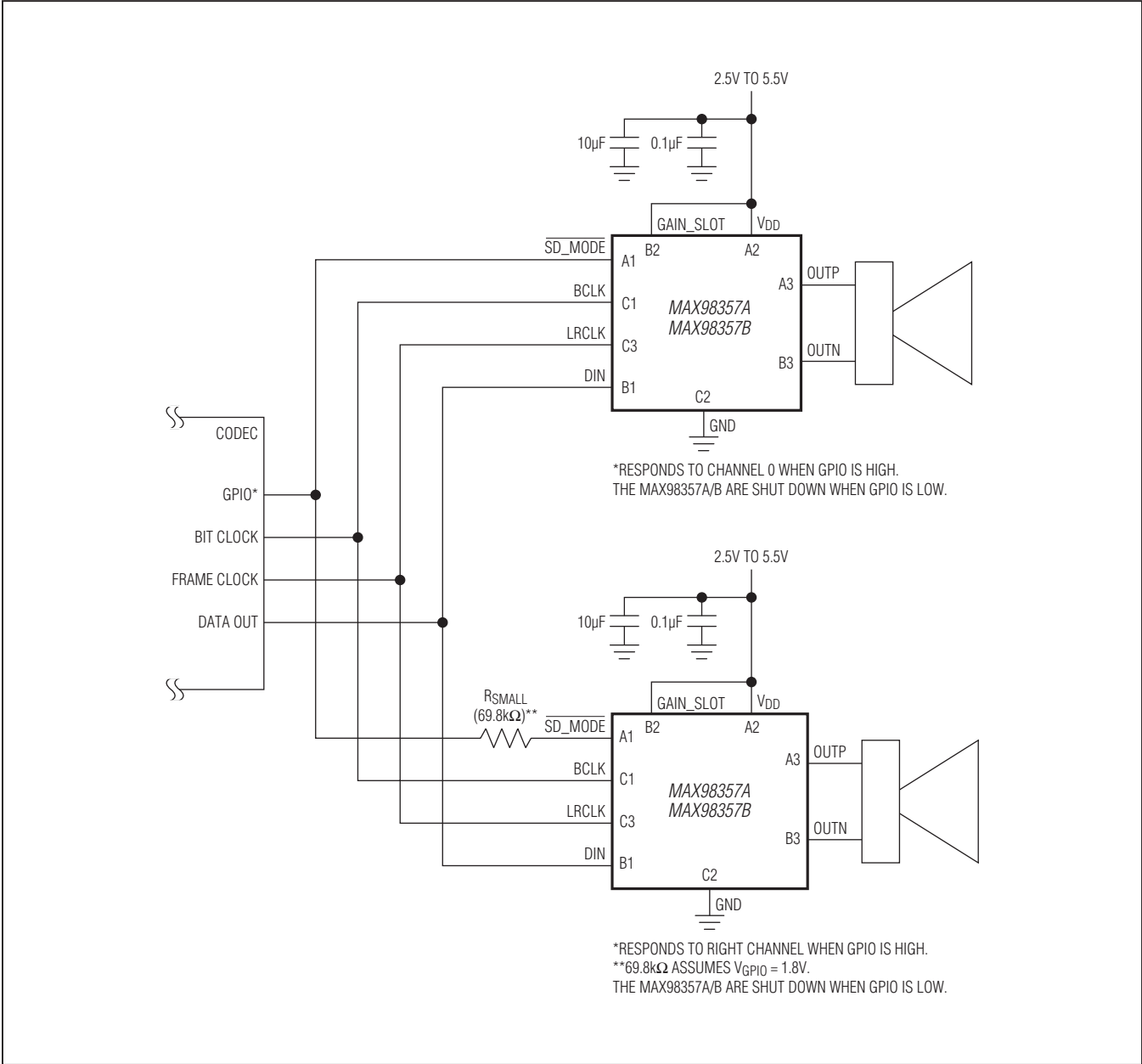

Figure 19. Stereo PCM Operation Using Two ICs





# MAX98357A/MAX98357B

## PCM Input Class D Audio Power Amplifiers

### Functional Diagram

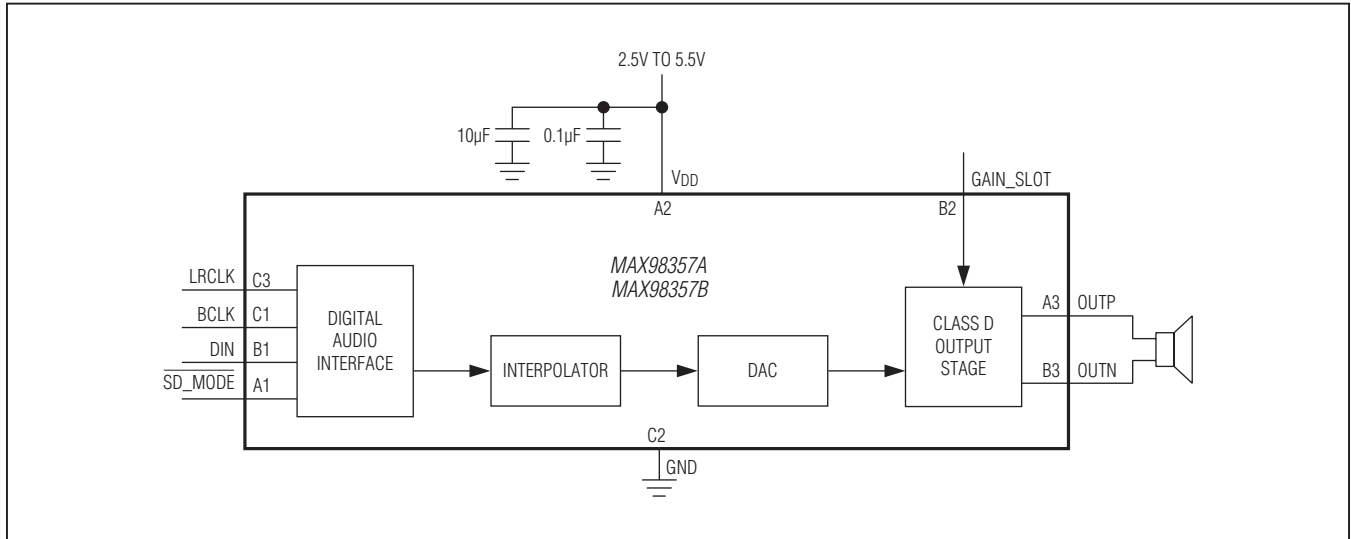

### Filterless Class D Operation

Traditional Class D amplifiers require an output filter to recover the audio signal from the amplifier's output. The filter adds cost, size, and decreases efficiency and THD+N performance. The ICs' filterless modulation scheme does not require an output filter. The device relies on the inherent inductance of the speaker coil and the natural filtering of both the speaker and the human ear to recover the audio component of the square-wave output.

Because the switching frequency of the ICs is well beyond the bandwidth of most speakers, voice coil movement due to the switching frequency is very small. Use a speaker with a series inductance  $> 10\mu\text{H}$ . Typical  $8\Omega$  speakers exhibit series inductances in the  $20\mu\text{H}$  to  $100\mu\text{H}$  range.

### Power-Supply Input

$V_{\text{DD}}$ , which ranges from 2.5V to 5.5V, powers the IC, including the speaker amplifier. Bypass  $V_{\text{DD}}$  with a  $0.1\mu\text{F}$  and  $10\mu\text{F}$  capacitor to GND. Some applications might require only the  $10\mu\text{F}$  bypass capacitor, making it possible to operate with a single external component. Apply additional bulk capacitance at the ICs if long input traces between  $V_{\text{DD}}$  and the power source are used.

### Layout and Grounding

Proper layout and grounding are essential for optimum performance. Good grounding improves audio performance and prevents switching noise from coupling into the audio signal.

Use wide, low-resistance output traces. As load impedance decreases, the current drawn from the device outputs increases. At higher current, the resistance of the output traces decreases the power delivered to the load. For example, if 2W is delivered from the speaker output to a  $4\Omega$  load through  $100\text{m}\Omega$  of total speaker trace, 1.904W is being delivered to the speaker. If power is delivered through  $10\text{m}\Omega$  of total speaker trace, 1.951W is being delivered to the speaker. Wide output, supply, and ground traces also improve the power dissipation of the ICs. Parasitic capacitance on the output traces cause higher quiescent current by  $V_{\text{DD}} \times 330\text{kHz} \times C_{\text{PARASITIC}}$ .

For example, at  $V_{\text{DD}} = 5\text{V}$  and a total parasitic capacitance of  $100\text{pF}$  ( $50\text{pF}$  on each output trace), the increase in quiescent current is  $5 \times 330\text{kHz} \times 100\text{pF} = 165\mu\text{A}$ .

The ICs are inherently designed for excellent RF immunity. For best performance, add ground fills around all signal traces on top or bottom PCB planes.

# MAX98357A/MAX98357B

## PCM Input Class D Audio Power Amplifiers

### WLP Applications Information

For the latest application details on WLP construction, dimensions, tape carrier information, PCB techniques, bump-pad layout, and recommended reflow temperature profile, as well as the latest information on reliability testing results, refer to the Application Note 1891: *Wafer-Level Packaging (WLP) and Its Applications*. [Figure 21](#) shows the dimensions of the WLP balls used on the ICs.

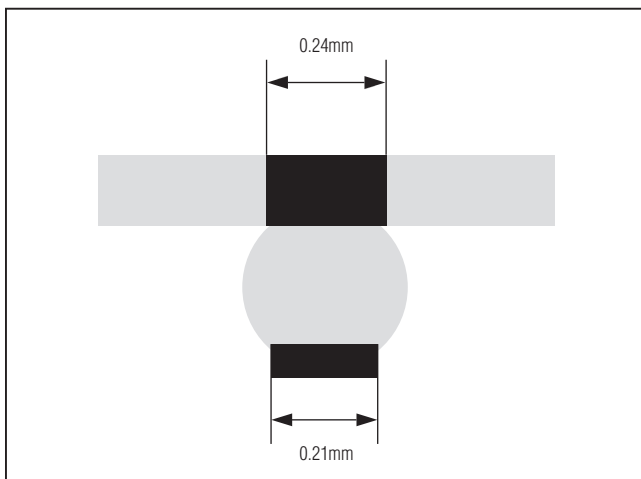

Figure 21. MAX98357A/MAX98357B WLP Ball Dimensions

### Ordering Information

PART	TEMP RANGE	PIN-PACKAGE	TOP MARK
<b>MAX98357A</b> ETE+*	-40°C to +85°C	16 TQFN	—
MAX98357AETE+T*	-40°C to +85°C	16 TQFN	—
MAX98357AEWL+T	-40°C to +85°C	9 WLP	+AKM
MAX98357AGTEN+*	-40°C to +105°C	16 TQFN	+AKV
<b>MAX98357B</b> ETE+*	-40°C to +85°C	16 TQFN	—
MAX98357BETE+T*	-40°C to +85°C	16 TQFN	—
MAX98357BEWL+T	-40°C to +85°C	9 WLP	+AKN

+Denotes a lead(Pb)-free/RoHS-compliant package.

T = Tape and reel.

N denotes an automotive-qualified part.

\*Future product—contact factory for availability.

# MAX98357A/MAX98357B

## PCM Input Class D Audio Power Amplifiers

### Package Information

For the latest package outline information and land patterns (footprints), go to [www.maximintegrated.com/packages](http://www.maximintegrated.com/packages). Note that a "+", "#", or "-" in the package code indicates RoHS status only. Package drawings may show a different suffix character, but the drawing pertains to the package regardless of RoHS status.

PACKAGE TYPE	PACKAGE CODE	OUTLINE NO.	LAND PATTERN NO.
9 WLP	W91F1+1	<a href="#">21-0896</a>	Refer to <a href="#">Application Note 1891</a>
16 TQFN	T1633+4	<a href="#">21-0136</a>	<a href="#">90-0031</a>

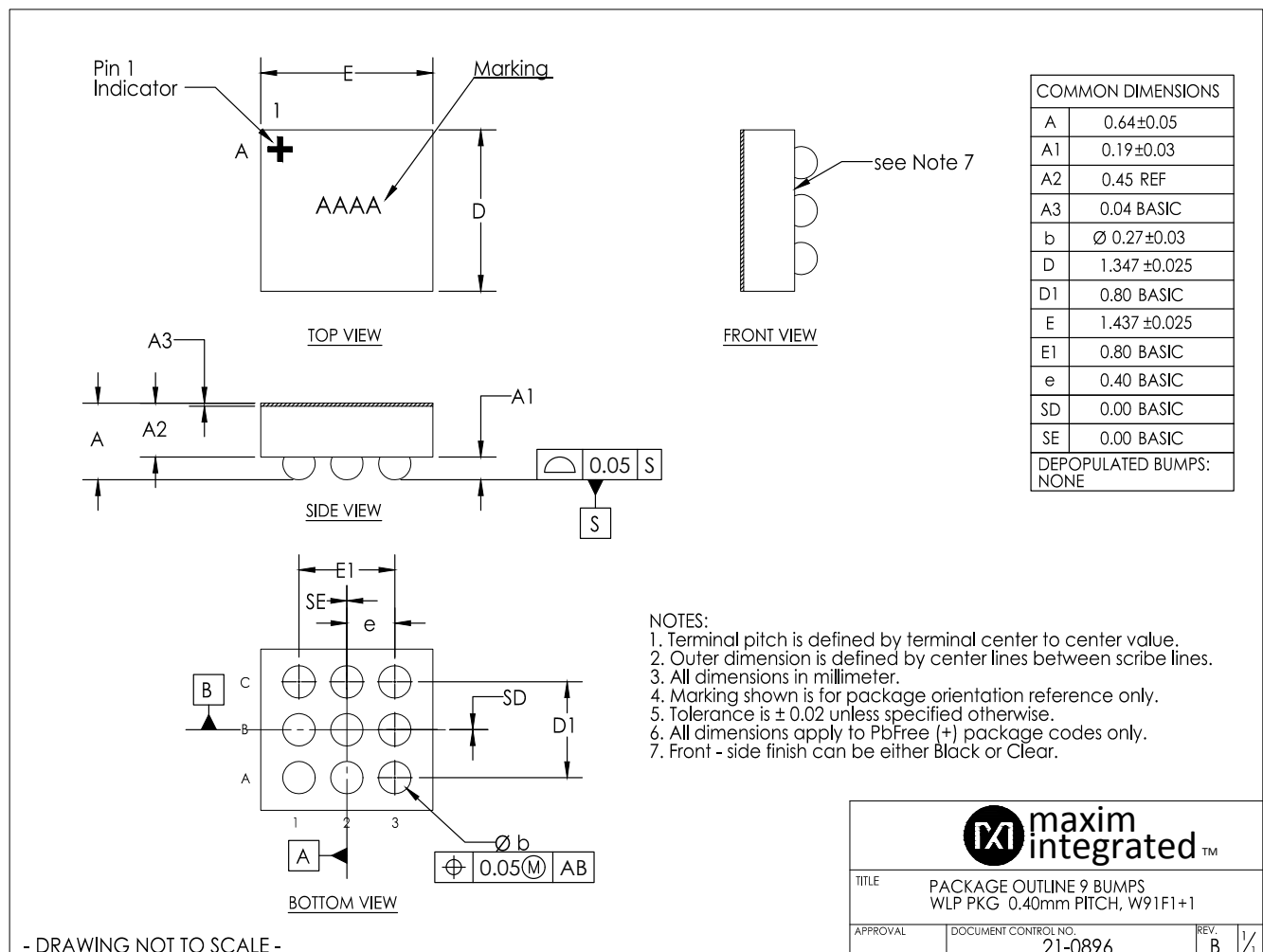

# MAX98357A/MAX98357B

## PCM Input Class D Audio Power Amplifiers

### Package Information (continued)

For the latest package outline information and land patterns (footprints), go to [www.maximintegrated.com/packages](http://www.maximintegrated.com/packages). Note that a "+", "#", or "-" in the package code indicates RoHS status only. Package drawings may show a different suffix character, but the drawing pertains to the package regardless of RoHS status.

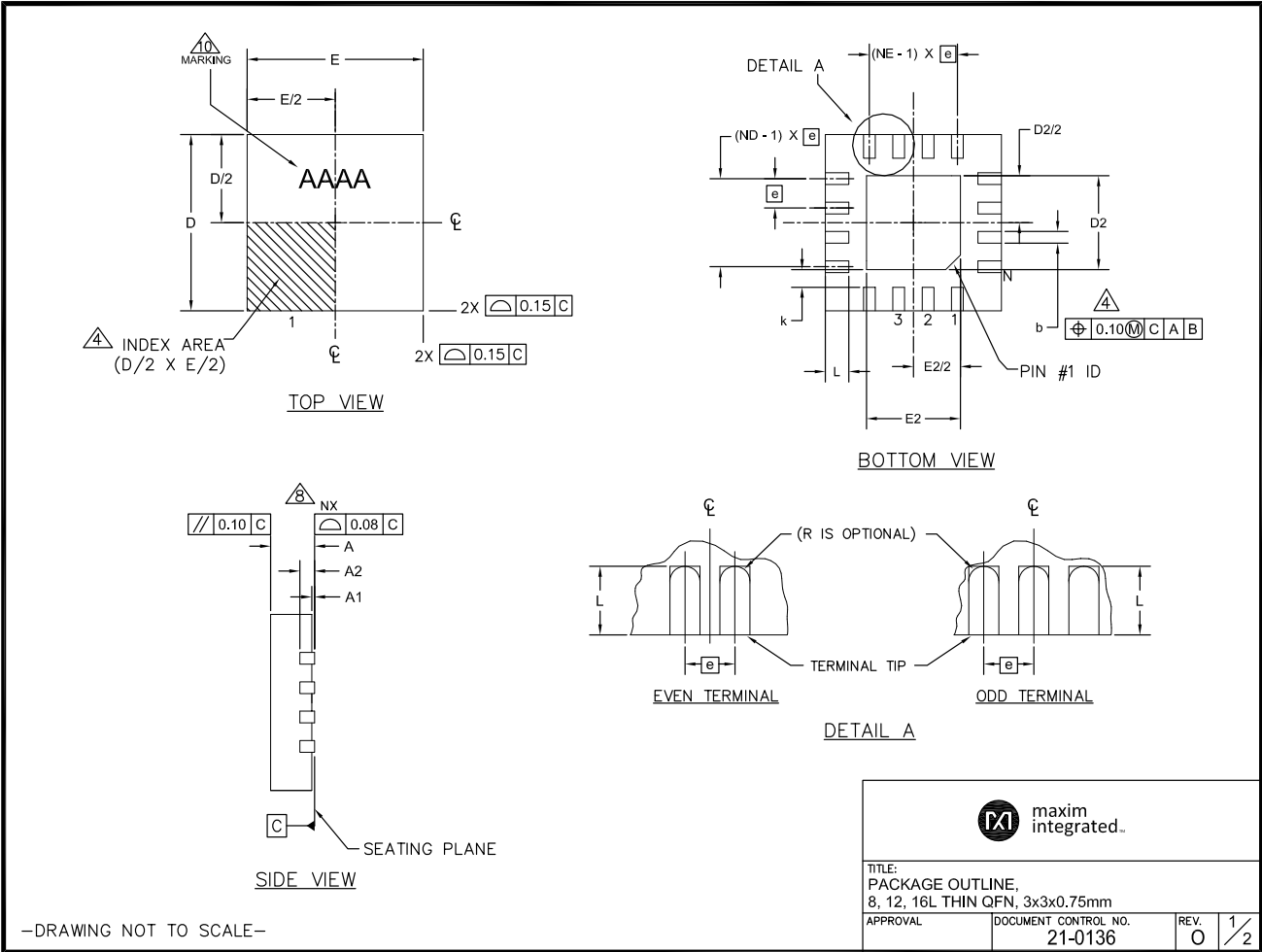

# MAX98357A/MAX98357B

## PCM Input Class D Audio Power Amplifiers

### Package Information (continued)

For the latest package outline information and land patterns (footprints), go to [www.maximintegrated.com/packages](http://www.maximintegrated.com/packages). Note that a "+", "#", or "-" in the package code indicates RoHS status only. Package drawings may show a different suffix character, but the drawing pertains to the package regardless of RoHS status.

PKG. REF.	8L 3x3			12L 3x3			16L 3x3		
	MIN.	NOM.	MAX.	MIN.	NOM.	MAX.	MIN.	NOM.	MAX.
A	0.70	0.75	0.80	0.70	0.75	0.80	0.70	0.75	0.80
b	0.25	0.30	0.35	0.20	0.25	0.30	0.20	0.25	0.30
D	2.90	3.00	3.10	2.90	3.00	3.10	2.90	3.00	3.10
E	2.90	3.00	3.10	2.90	3.00	3.10	2.90	3.00	3.10
e	0.65 BSC.			0.50 BSC.			0.50 BSC.		
L	0.35	0.55	0.75	0.45	0.55	0.65	0.30	0.40	0.50
N	8			12			16		
ND	2			3			4		
NE	2			3			4		
A1	0	0.02	0.05	0	0.02	0.05	0	0.02	0.05
A2	0.20 REF			0.20 REF			0.20 REF		
k	0.25	-	-	0.25	-	-	0.25	-	-

PKG. CODES	D2			E2			PIN ID	JEDEC
	MIN.	NOM.	MAX.	MIN.	NOM.	MAX.		
TQ833-1	0.25	0.70	1.25	0.25	0.70	1.25	0.35 x 45°	WEEC
T1233-1	0.95	1.10	1.25	0.95	1.10	1.25	0.35 x 45°	WEED-1
T1233-3	0.95	1.10	1.25	0.95	1.10	1.25	0.35 x 45°	WEED-1
T1633-2	0.95	1.10	1.25	0.95	1.10	1.25	0.35 x 45°	WEED-2
T1633-2C	0.95	1.10	1.25	0.95	1.10	1.25	0.35 x 45°	WEED-2
T1633F-3	0.65	0.80	0.95	0.65	0.80	0.95	0.225 x 45°	WEED-2
T1633FH-3	0.65	0.80	0.95	0.65	0.80	0.95	0.225 x 45°	WEED-2
T1633-4	0.95	1.10	1.25	0.95	1.10	1.25	0.35 x 45°	WEED-2
T1633-4C	0.95	1.10	1.25	0.95	1.10	1.25	0.35 x 45°	WEED-2
T1633MK-5	0.95	1.10	1.25	0.95	1.10	1.25	0.35 x 45°	WEED-2

PKG. CODES	D2			E2			L			PIN ID
	MIN.	NOM.	MAX.	MIN.	NOM.	MAX.	MIN.	NOM.	MAX.	
T1233-4	0.95	1.10	1.25	0.95	1.10	1.25	0.35	0.45	0.55	0.35 x 45°
T1633-5	0.95	1.10	1.25	0.95	1.10	1.25	0.25	0.35	0.45	0.35 x 45°
T1633-5C	0.95	1.10	1.25	0.95	1.10	1.25	0.25	0.35	0.45	0.35 x 45°

NOTES:

- DIMENSIONING & TOLERANCING CONFORM TO ASME Y14.5M-1994.
  - ALL DIMENSIONS ARE IN MILLIMETERS. ANGLES ARE IN DEGREES.
  - N IS THE TOTAL NUMBER OF TERMINALS.
  - THE TERMINAL #1 IDENTIFIER AND TERMINAL NUMBERING CONVENTION SHALL CONFORM TO JESD 95-1 SPP-012. DETAILS OF TERMINAL #1 IDENTIFIER ARE OPTIONAL, BUT MUST BE LOCATED WITHIN THE ZONE INDICATED. THE TERMINAL #1 IDENTIFIER MAY BE EITHER A MOLD OR MARKED FEATURE.
  - DIMENSION b APPLIES TO METALLIZED TERMINAL AND IS MEASURED BETWEEN 0.20 mm AND 0.25 mm FROM TERMINAL TIP.
  - ND AND NE REFER TO THE NUMBER OF TERMINALS ON EACH D AND E SIDE RESPECTIVELY.
  - DEPOPULATION IS POSSIBLE IN A SYMMETRICAL FASHION.
  - COPLANARITY APPLIES TO THE EXPOSED HEAT SINK SLUG AS WELL AS THE TERMINALS.
  - DRAWING CONFORMS TO JEDEC MO220 REVISION C. T1233-4, T1633-5 AND T1633-5C WITH CUSTOM LEAD DIMENSION.
  - MARKING SHOWN IS FOR PACKAGE ORIENTATION REFERENCE ONLY.
  - NUMBER OF LEADS SHOWN ARE FOR REFERENCE ONLY.
  - WARPAGE NOT TO EXCEED 0.10mm.
  - ALL DIMENSIONS APPLY TO BOTH LEADED (-) AND Pb FREE (+) PARTS.
- DRAWING NOT TO SCALE—



TITLE: PACKAGE OUTLINE, 8, 12, 16L THIN QFN, 3x3x0.75mm		
APPROVAL	DOCUMENT CONTROL NO. 21-0136	REV. O 2/2

# MAX98357A/MAX98357B

## PCM Input Class D Audio Power Amplifiers

### Revision History

REVISION NUMBER	REVISION DATE	DESCRIPTION	PAGES CHANGED
0	9/13	Initial release	—
1	11/13	Added two new TOCs, replaced TOC 29, updated Figures 1–3, and made various corrections	1, 4–20, 29–32, 34
2	8/14	Added THD+N for TQFN package with typical spec	5
3	1/15	Updated spread-spectrum bandwidth spec	5, 28
4	2/15	Added automotive-qualified part	34
5	6/15	Updated TOCs 30a and 30b	12
6	8/15	Corrected package outline for WLP package	36



Maxim Integrated cannot assume responsibility for use of any circuitry other than circuitry entirely embodied in a Maxim Integrated product. No circuit patent licenses are implied. Maxim Integrated reserves the right to change the circuitry and specifications without notice at any time. The parametric values (min and max limits) shown in the Electrical Characteristics table are guaranteed. Other parametric values quoted in this data sheet are provided for guidance.

**Maxim Integrated 160 Rio Robles, San Jose, CA 95134 USA 1-408-601-1000**

38

Компания «Life Electronics» занимается поставками электронных компонентов импортного и отечественного производства от производителей и со складов крупных дистрибьюторов Европы, Америки и Азии.

С конца 2013 года компания активно расширяет линейку поставок компонентов по направлению коаксиальный кабель, кварцевые генераторы и конденсаторы (керамические, пленочные, электролитические), за счёт заключения дистрибьюторских договоров

Мы предлагаем:

- Конкурентоспособные цены и скидки постоянным клиентам.
- Специальные условия для постоянных клиентов.
- Подбор аналогов.
- Поставку компонентов в любых объемах, удовлетворяющих вашим потребностям.
- Приемлемые сроки поставки, возможна ускоренная поставка.
- Доставку товара в любую точку России и стран СНГ.
- Комплексную поставку.
- Работу по проектам и поставку образцов.
- Формирование склада под заказчика.
- Сертификаты соответствия на поставляемую продукцию (по желанию клиента).
- Тестирование поставляемой продукции.
- Поставку компонентов, требующих военную и космическую приемку.
- Входной контроль качества.
- Наличие сертификата ISO.

В составе нашей компании организован Конструкторский отдел, призванный помогать разработчикам, и инженерам.

Конструкторский отдел помогает осуществить:

- Регистрацию проекта у производителя компонентов.
- Техническую поддержку проекта.
- Защиту от снятия компонента с производства.
- Оценку стоимости проекта по компонентам.
- Изготовление тестовой платы монтаж и пусконаладочные работы.



Тел: +7 (812) 336 43 04 (многоканальный)

Email: [org@lifeelectronics.ru](mailto:org@lifeelectronics.ru)