

Virtex-7 FPGA VC7222 GTH and GTZ Transceiver Characterization Board

User Guide

UG965 (v1.4) February 11, 2015



DISCLAIMER

The information disclosed to you hereunder (the “Materials”) is provided solely for the selection and use of Xilinx products. To the maximum extent permitted by applicable law: (1) Materials are made available “AS IS” and with all faults. Xilinx hereby DISCLAIMS ALL WARRANTIES AND CONDITIONS, EXPRESS, IMPLIED, OR STATUTORY, INCLUDING BUT NOT LIMITED TO WARRANTIES OF MERCHANTABILITY, NON-INFRINGEMENT, OR FITNESS FOR ANY PARTICULAR PURPOSE; and (2) Xilinx shall not be liable (whether in contract or tort, including negligence, or under any other theory of liability) for any loss or damage of any kind or nature related to, arising under, or in connection with, the Materials (including your use of the Materials), including for any direct, indirect, special, incidental, or consequential loss or damage (including loss of data, profits, goodwill, or any type of loss or damage suffered as a result of any action brought by a third party) even if such damage or loss was reasonably foreseeable or Xilinx had been advised of the possibility of the same. Xilinx assumes no obligation to correct any errors contained in the Materials or to notify you of updates to the Materials or to product specifications. You may not reproduce, modify, distribute, or publicly display the Materials without prior written consent. Certain products are subject to the terms and conditions of Xilinx’s limited warranty, please refer to Xilinx’s Terms of Sale which can be viewed at www.xilinx.com/legal.htm#tos; IP cores may be subject to warranty and support terms contained in a license issued to you by Xilinx. Xilinx products are not designed or intended to be fail-safe or for use in any application requiring fail-safe performance; you assume sole risk and liability for use of Xilinx products in such critical applications, please refer to Xilinx’s Terms of Sale which can be viewed at www.xilinx.com/legal.htm#tos.

© Copyright 2013–2015 Xilinx, Inc. Xilinx, the Xilinx logo, Artix, ISE, Kintex, Spartan, Virtex, Vivado, Zynq, and other designated brands included herein are trademarks of Xilinx in the United States and other countries. All other trademarks are the property of their respective owners.

Revision History

The following table shows the revision history for this document.

Date	Version	Revision
01/25/2013	1.0	Initial Xilinx release.
01/30/2013	1.0.1	Corrected callout links located throughout the body text back to Table 1-1, page 7 . Added answer record link in References, page 61 .
07/23/2013	1.1	In Table 1-4 , changed nominal voltage to 1.075 V. In Figure 1-3 , changed MGTZAVCC and MGTZVCCCL voltages to 1.075V. Added a footnote about critical signals to Table 1-20 and Table 1-21 . In Appendix C , replaced user constraints file (UCF) with Xilinx Design Constraints (XDC) information. Updated links.
09/20/2013	1.1.1	Updated the <i>Virtex-7 FPGA VC7222 IBERT Getting Started Guide (Vivado Design Suite)</i> (UG971) link in Appendix D, Additional Resources .
12/18/2013	1.2	Revised Table 1-7 through Table 1-12 , Table 1-18 , and Table 1-19 . Rearranged rows in Table 1-21 . Updated references in Appendix D, Additional Resources . Updated the Declaration of Conformity link in Appendix E, Regulatory and Compliance Information .
08/21/2014	1.3	The number of 7 series GTH power modules from third-party vendors supplied with the VC7222 board changed from four to two. Appendix C was renamed Master Constraints File Listing . Intersil and Lineage vendors were removed from References, page 61 .
02/11/2015	1.4	Two power modules are provided with the VC7222 board—Texas Instruments PMP6577 and Bellnix BPE-37 (for 7 Series GTH Transceiver Power Module, page 13 and 7 Series GTZ Transceiver Power Module, page 15 . Updated VC7222 Board XDC Listing, page 47 .

Table of Contents

Revision History	2
Chapter 1: VC7222 Board Features and Operation	
VC7222 Board Features	5
Detailed Description	6
Appendix A: Default Jumper and Switch Settings	
Appendix B: VITA 57.1 FMC Connector Pinouts	
Appendix C: Master Constraints File Listing	
VC7222 Board XDC Listing	47
Appendix D: Additional Resources	
Xilinx Resources	61
Solution Centers	61
References	61
Appendix E: Regulatory and Compliance Information	
Declaration of Conformity	63
Directives	63
Standards	63
Markings	64

VC7222 Board Features and Operation

This chapter describes the components, features, and operation of the Virtex®-7 FPGA VC7222 GTH and GTZ Transceiver Characterization Board. The VC7222 board provides the hardware environment for characterizing and evaluating the GTH and GTZ transceivers available on the Virtex-7 XC7VH580T-G2HCG1155E FPGA. The VC7222 board schematic, bill-of-material (BOM), layout files, and reference designs are available online at the [Virtex-7 FPGA VC7222 Characterization Kit documentation website](#).

VC7222 Board Features

- Virtex-7 XC7VH580T-G2HCG1155E FPGA
- Onboard power supplies for all necessary voltages
- Terminal blocks for optional use of external power supplies
- Digilent USB JTAG programming port
- System ACE™ SD controller
- Power module supporting Virtex-7 FPGA GTH transceiver power requirements
- Power module supporting Virtex-7 FPGA GTZ transceiver power requirements
- A fixed, 200 MHz 2.5V LVDS oscillator wired to multi-region clock capable (MRCC) inputs
- Two pairs of differential MRCC inputs with SMA connectors
- SuperClock-2 module supporting multiple frequencies
- Six Samtec BullsEye connector pads for the GTH transceivers and reference clocks
- Two Samtec BullsEye connector pads for the GTZ transceivers and two pairs of SMA connectors for GTZ transceiver reference clocks
- Power status LEDs
- General purpose DIP switches, LEDs, pushbuttons, and test I/O
- Two VITA 57.1 FPGA mezzanine card (FMC) high pin count (HPC) connectors
- USB-to-UART bridge
- I2C bus
- PMBus connectivity to onboard digital power supplies
- Active cooling for the FPGA

The VC7222 board block diagram is shown in Figure 1-1.

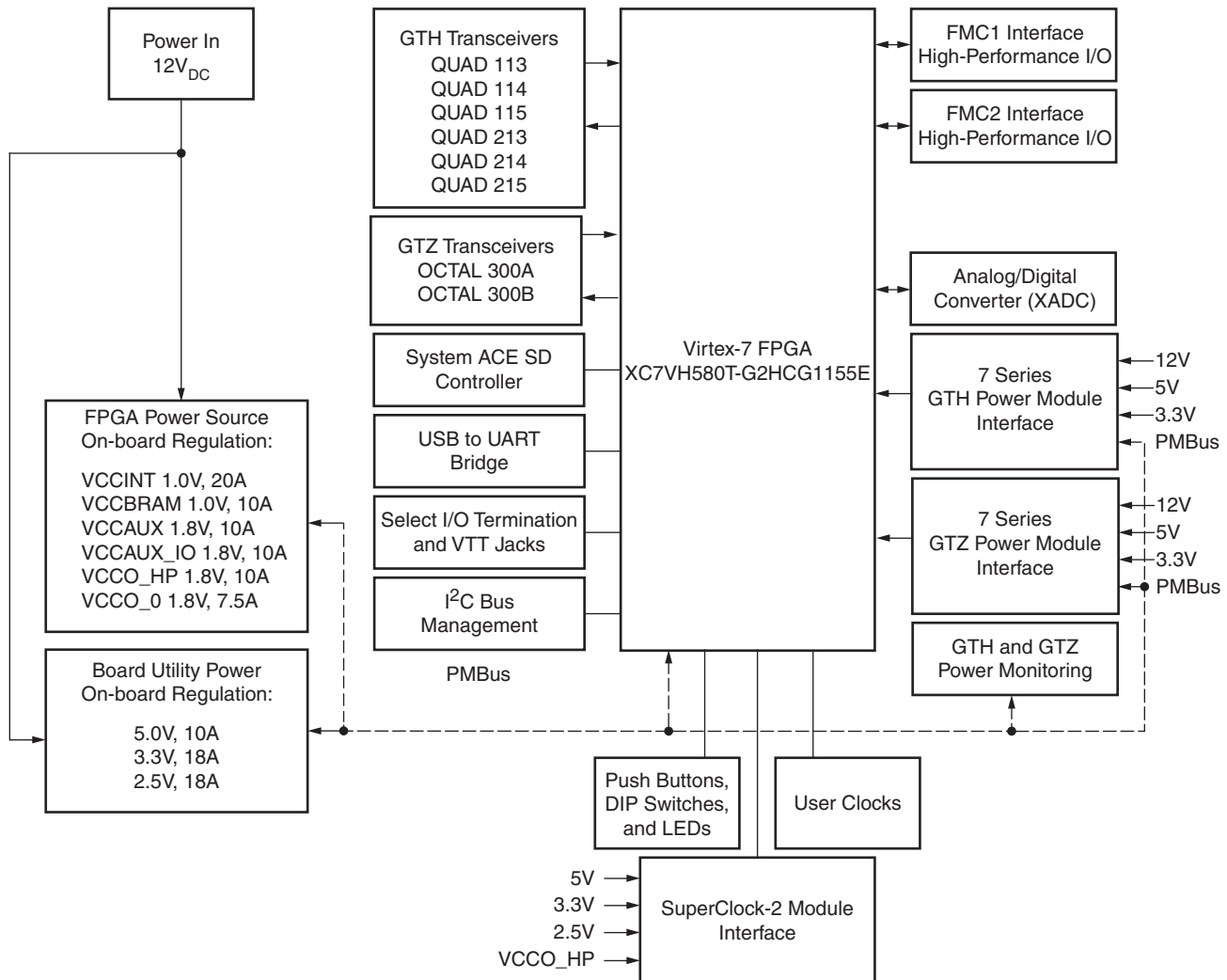

UG965_c1_01_070313

Figure 1-1: VC7222 Board Block Diagram

Detailed Description

Figure 1-2 shows the VC7222 board described in this user guide. Each numbered feature that is referenced in Figure 1-2 is described in Table 1-1 and later sections.

The VC7222 board can be damaged by electrostatic discharge (ESD). Follow standard ESD prevention measures when handling the board.

Caution! Do not remove the rubber feet from the board. The feet provide clearance to prevent short circuits on the back side of the board.

Note: Figure 1-2 is for reference only and might not reflect the current revision of the board.

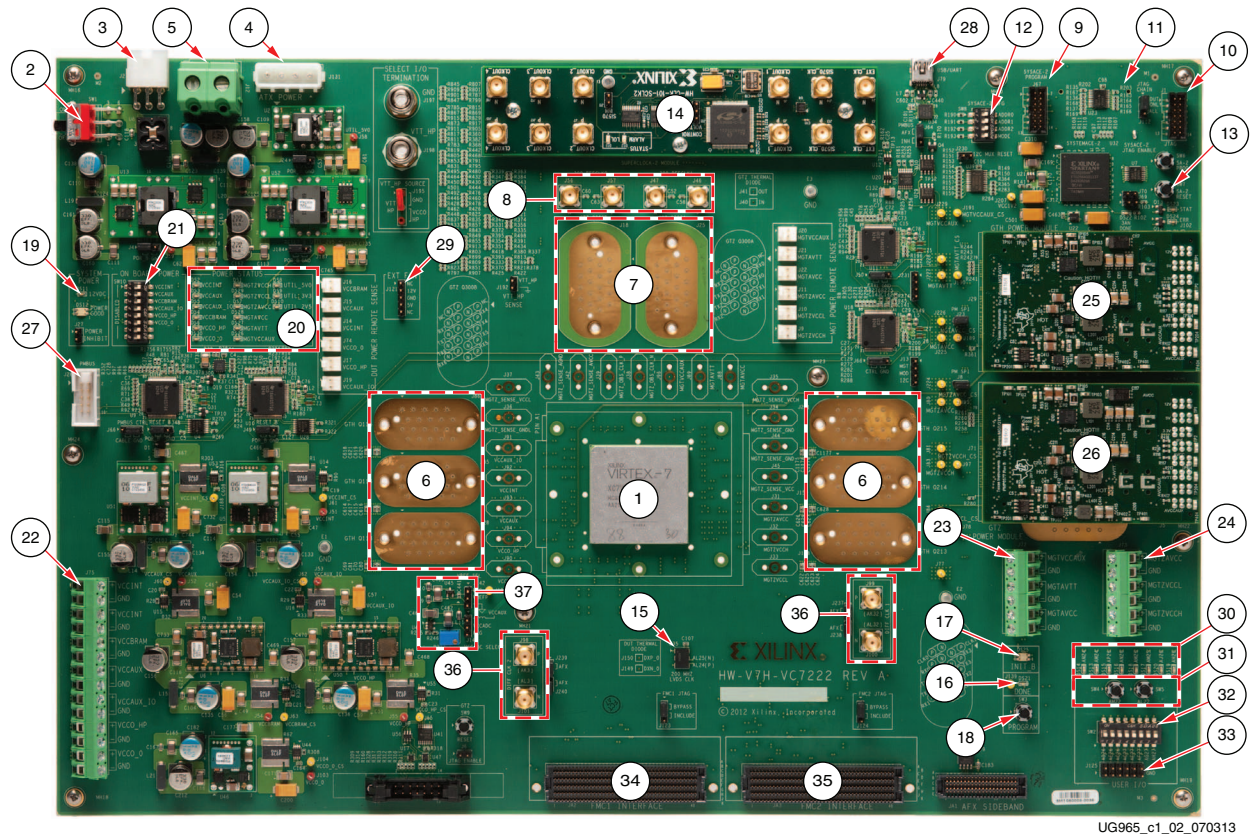

UG965_c1_02_070313

Figure 1-2: VC7222 Board Features. Callouts Listed in Table 1-1

Table 1-1: VC7222 Board Feature Descriptions

Figure 1-2 Callout	Reference Designator	Feature Description
1	U1	Virtex-7 XC7VH580T-G2HCG1155E FPGA
2	SW1	Power switch
3	J2	12V Mini-Fit connector
4	J131	12V ATX Connector
5	J12	12V Euro-Mag Connector
6	J28, J85, J86, J158, J159, J241	GTH transceiver connector pads Q113, Q114, Q115, Q213, Q214 and Q215
7	J18, J25	GTZ transceiver connector pads O300A and O300B
8	J46, J47, J56, J57	GTZ transceiver reference clock SMAs
9	U57	USB JTAG connector (micro-B receptacle)
10	J1	JTAG connector (alternate access for programming cables)
11	J30	System ACE SD card connector (back-side of board)
12	SW8	System ACE SD configuration address DIP switches

Table 1-1: VC7222 Board Feature Descriptions (Cont'd)

Figure 1-2 Callout	Reference Designator	Feature Description
13	SW7	System ACE SD RESET button
14		SuperClock-2 module
15	U35	200 MHz 2.5V LVDS oscillator
16	DS21	FPGA DONE status LED
17	DS25	FPGA INIT_B status LED
18	SW3	FPGA PROG_B pushbutton
19	DS11	12V power status LED
20	DS1, DS2, DS3, DS4, DS5, DS6, DS7, DS8, DS9, DS10, DS26, DS27, DS28, DS29, DS30	Status LEDs for FPGA logic, transceiver and utility power
21	SW10	Core power regulation enable switches
22	J75	Core power terminal block
23	J72	GTH transceiver power terminal block
24	J73	GTZ transceiver power terminal block
25		GTH transceiver power supply module
26		GTZ transceiver power supply module
27	J26	PMBUS connector
28	J79	Connector for USB to UART bridge (mini-B receptacle)
29	J121	Power connector for active heatsink
30	DS13, DS14, DS15, DS16, DS17, DS18, DS19, DS20	User LEDs (active high)
31	SW4, SW5	User pushbuttons (active high)
32	SW2	User DIP switches (active high)
33	J125	User I/O header
34	JA2	FMC1 connector
35	JA3	FMC2 connector
36	J98, J99, J100, J101	SMA connectors to differential MRCC pins on FPGA
37	J141, J142, R233	Jumpers and potentiometer for XADC reference and analog supply set-up

Power Management

Board 12V Input Power

VC7222 board receives 12V main power through J2 (callout 3, [Figure 1-2](#)) using the 12V AC adapter that ships with the board. J2 is a 6-pin (2 x 3), right angle, Mini-Fit connector.

Caution! When supplying 12V through J2, use only the power supply provided for use with this board (Xilinx part number 3800033).

Caution! Do **NOT** use a 6-pin, PC ATX power supply connector with J2. The pinout of the 6-pin, PC ATX connector is not compatible J2 and the board will be damaged if an attempt is made to power it from a PC ATX power supply connector.

12V power can also be provided through:

- Connector J131 which accepts an ATX hard drive, 4-pin, power plug
- Euro-Mag terminal block J12 which can be connected to a bench-top power supply

Caution! Because terminal block J12 provides no reverse polarity protection, use a power supply with a current limit set at 6A max.

Caution! Do **NOT** apply 12V power to more than a single input source. For example, do not apply power to J2 and J131 at the same time.

Power Switch

Main board power is turned on or off using switch SW1 (callout 2, [Figure 1-2](#)). When the switch is in the ON position, power is applied to the board and green LED DS11 illuminates (callout 19, [Figure 1-2](#)).

Onboard Power Regulation

[Figure 1-3](#) shows the onboard power supply architecture.

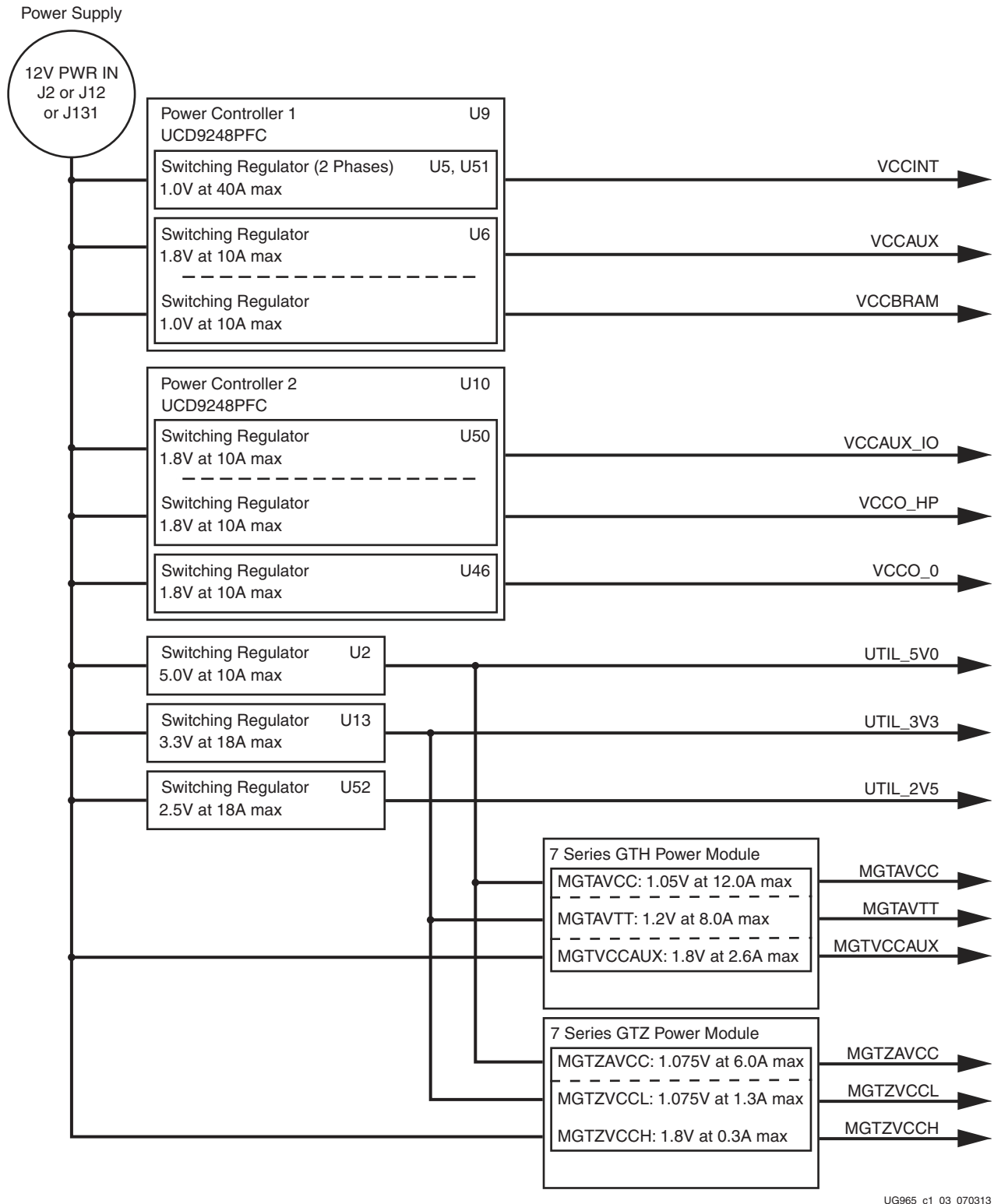

UG965_c1_03_070313

Figure 1-3: VC7222 Board Power Supply Block Diagram

The VC7222 board uses power regulators and PMBus compliant digital PWM system controllers from Texas Instruments to supply the FPGA logic and utility voltages listed in

Table 1-2. The board can also be configured to use an external bench power supply for each voltage. See [Using External Power Sources](#).

Table 1-2: Onboard Power System Devices

Device	Reference Designator(s)	Description	Power Rail Net Name	Voltage
Core Power				
UCD9248PFC	U9	PMBus compliant digital PWM system controller (address = 52)		
PTD08A020W	U5, U51	Adjustable ⁽¹⁾ switching regulator, 40A (two phases at 20A/phase), 0.6V to 3.6V	VCCINT	1.0V
PTD08D210W (V _{OUTA})	U6	Adjustable ⁽¹⁾ switching regulator, Dual 10A, 0.6V to 3.6V	VCCAUX	1.8V
PTD08D210W (V _{OUTB})		Adjustable ⁽¹⁾ switching regulator, Dual 10A, 0.6V to 3.6V	VCCBRAM	1.0V
UCD9248PFC	U10	PMBus compliant digital PWM system controller (address = 53)		
PTD08D210W (V _{OUTA})	U50	Adjustable ⁽¹⁾ switching regulator, Dual 10A, 0.6V to 3.6V	VCCAUX_IO	1.8V
PTD08D210W (V _{OUTB})		Adjustable ⁽¹⁾ switching regulator, Dual 10A, 0.6V to 3.6V	VCCO_HP	1.8V
PTD08A006W	U46	Adjustable ⁽¹⁾ switching regulator, 10A, 0.6V to 3.6V	VCCO_0	1.8V
GTH Transceivers (monitoring only)				
UCD9248PFC ⁽²⁾	U11	PMBus compliant digital PWM system controller (address = 54)		
GTZ Transceivers (monitoring only)				
UCD9248PFC ⁽³⁾	U18	PMBus compliant digital PWM system controller (address = 55)		
Utility				
PTH12060W	U2	Fixed switching regulator, 10A	UTIL_5V0	5.0V
PTH12020W	U13	Fixed switching regulator, 18A	UTIL_3V3	3.3V
PTH12020W	U52	Fixed switching regulator, 18A	UTIL_2V5	2.5V
XADC⁽⁴⁾				
ADP123	U43	Fixed LDO regulator	VCCADC_ADP	1.8V
REF3012	U45	Fixed LDO regulator	VREFP_3012	1.25V
System ACE SD				
ADP123	U21	Fixed LDO Regulator	VCC1V2	1.2V

Notes:

1. The output voltages of regulators controlled by a UCD9248 can be reprogrammed using the Texas Instruments Fusion Digital Power Designer application (www.ti.com/tool/fusion_digital_power_designer). However, **extreme caution must be taken when attempting to modify any of the onboard regulators. An incorrectly programmed regulator can damage onboard components.**
2. The UCD9248PFC (U11) at Address 54 monitors MGTAVCC, MGTAVTT, and MGTVCCAUX rail voltage and current levels which can be observed in real time using the Texas Instruments Fusion Digital Power Designer application (see [Monitoring Voltage and Current, page 13](#)). Transceiver supply voltages cannot be changed from this controller.
3. The UCD9248PFC (U18) at Address 55 monitors MGTZAVCC, MGTZVCCCL, and MGTZVCCCH rail voltage and current levels which can be observed in real time using the Texas Instruments Fusion Digital Power Designer application (see [Monitoring Voltage and Current, page 13](#)). Transceiver supply voltages cannot be changed from this controller.
4. For information on XADC see *7 Series FPGAs and Zynq-7000 All Programmable SoC XADC Dual 12-Bit 1 MSPS Analog-to-Digital Converter User Guide (UG480)* [Ref 1].

Using External Power Sources

The maximum output current rating for each power regulator is listed in [Table 1-2](#). If a design exceeds this value on any core power rail, power for that rail must be supplied externally through the 14-position core power terminal block J75 shown in [Figure 1-4](#) (callout 22, [Figure 1-2](#)) using a supply capable of providing the required current.



Figure 1-4: Core Power Terminal Block J75

Caution! The SW10 power regulator enable switch (callout 21, [Figure 1-2](#)) (see [Disabling Onboard Power](#)) must be set to the OFF position before turning ON the main power switch (SW1) and applying external power to the corresponding rail input pin on the core power terminal block J75 (callout 22, [Figure 1-2](#)).

Caution! The core power terminal block J75 has a maximum load current contact rating of 24A.

Disabling Onboard Power

Each core power regulator can be disabled through the 8-position regulator enable DIP switch, SW10 as shown in [Figure 1-5](#). A switch in the ON position means the rail is supplied by an onboard regulator. Setting a switch in the opposite (OFF) position disables onboard power for that rail. SW10 is shown in [Figure 1-2](#) as callout 21.



Figure 1-5: Core Power Regulator Enable Switches SW10

Default Jumper and Switch Positions

A list of jumpers and switches and their required positions for normal board operation is provided in [Appendix A, Default Jumper and Switch Settings](#).

Monitoring Voltage and Current

Voltage and current monitoring and control are available for FPGA core and transceiver power rails through Texas Instruments' Fusion Digital Power graphical user interface (GUI). The four onboard TI power controllers (U9 at PMBUS address 52, U10 at PMBUS address 53, U11 at PMBUS address 54, and U18 at PMBUS address 55) are wired to the same PMBus. The PMBus connector, J26 (callout 27, [Figure 1-2](#)), is provided for use with the TI USB Interface Adapter PMBus pod and associated TI GUI.

References

More information about the power system components used by the VC7222 board are available from the Texas Instruments digital power website [\[Ref 2\]](#).

7 Series GTH Transceiver Power Module

The 7 series GTH transceiver power module (callout 25, [Figure 1-2](#)) supplies MGTAVCC, MGTAVTT and MGTVCCAUX voltages to the FPGA GTH transceivers. Two 7 series GTH power modules from third-party vendors are provided with the VC7222 board for evaluation, Texas Instruments PMP6577 and Bellnix BPE-37. Either of the two GTH modules can be plugged into connectors J29 and J102 in the outlined and labeled power module location shown in [Figure 1-6](#).

Caution! To ensure proper operation, do not plug a GTZ power module into the GTH power module location shown in Figure 1-6. Pay close attention when connecting the GTH or the GTZ power modules to the board. Both power modules have the same mechanical footprint and can be plugged into either the GTH or GTZ board interface.

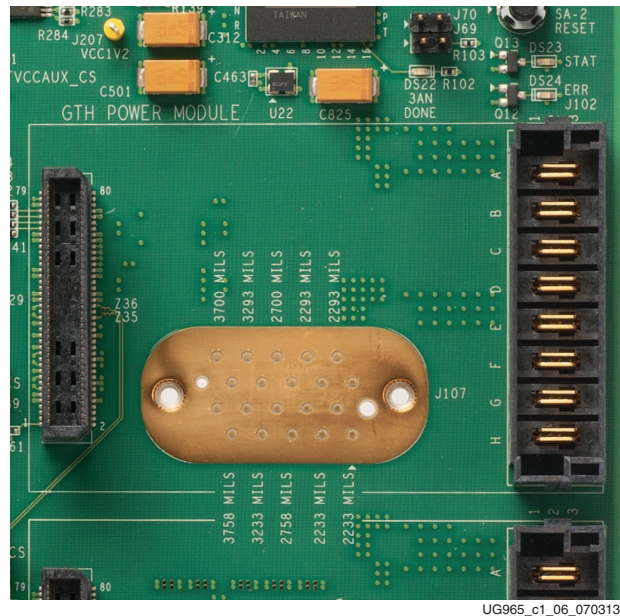

Figure 1-6: Mounting Location, 7 Series GTH Transceiver Power Module

Table 1-3 lists the nominal voltage values for the MGTAVCC, MGTAVTT and MGTVCCAUX power rails. It also lists the maximum current rating for each rail supplied by 7 series GTH modules included with the VC7222 board.

Table 1-3: 7 Series GTH Transceiver Power Module

GTH Transceiver Rail Net Name	Nominal Voltage	Maximum Current Rating
MGTAVCC	1.05V	12A
MGTAVTT	1.2V	8A
MGTVCCAUX	1.8V	2.6A

The GTH transceiver power rails also have corresponding inputs on the GTH transceiver power terminal block J72 as shown in Figure 1-7 to supply each voltage independently from a bench-top power source. J72 is shown in Figure 1-2 as callout 23.

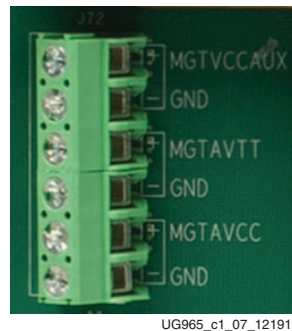

Figure 1-7: GTH Transceiver Power Terminal Block J72

Caution! The 7 series GTH module **MUST** be removed when providing external power to the GTH transceiver rails.

Information about the 7 series GTH power supply modules included with the VC7222 Characterization Kit is available from the vendor websites [Ref 3].

7 Series GTZ Transceiver Power Module

The 7 series GTZ transceiver power module (callout 26, Figure 1-2) supplies MGTZAVCC, MGTZVCCL and MGTZVCCH voltages to the FPGA GTZ transceivers. Two 7 series GTZ power modules from third-party vendors are provided with the VC7222 board for evaluation, Texas Instruments PMP6577 and Bellnix BPE-37. Either of the two GTZ modules can be plugged into connectors J5 and J71 in the outlined and labeled power module location shown in Figure 1-8.

Caution! To ensure proper operation, do not plug a GTH power module into the GTZ power module location shown in Figure 1-8. Pay close attention when connecting the GTH or the GTZ power modules to the board. Both power modules have the same mechanical footprint and can be plugged into either the GTH or GTZ board interface.

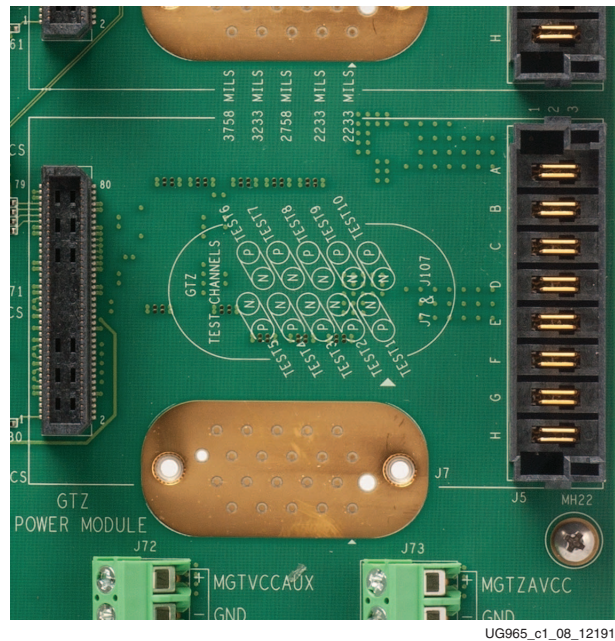

Figure 1-8: Mounting Location, 7 Series GTZ Transceiver Power Module

Table 1-4 lists the nominal voltage values for the MGTZAVCC, MGTZVCCL and MGTZVCCH power rails. It also lists the maximum current rating for each rail supplied by 7 series GTZ modules included with the VC7222 board.

Table 1-4: 7 Series GTZ Transceiver Power Module

GTZ Transceiver Rail Net Name	Nominal Voltage	Maximum Current Rating
MGTZVCC	1.075V	6A
MGTZVCCL	1.075V	1.3A
MGTZVCCH	1.8V	0.300A

The GTZ transceiver power rails also have corresponding inputs on the GTZ transceiver power terminal block J73 as shown in [GTZ Transceiver Power Terminal Block J73 Figure 1-9](#) to supply each voltage independently from a bench-top power source. J73 is shown in [Figure 1-2](#) as callout 24.



Figure 1-9: GTZ Transceiver Power Terminal Block J73

Caution! The 7 series GTZ module MUST be removed when providing external power to the GTZ transceiver rails.

Caution! The GTZ transceiver power terminal block J73 has a maximum load current contact rating of 24A.

Information about the two 7 series GTZ power supply modules included with the VC7222 kit is available from the vendor websites [\[Ref 3\]](#).

Active Heat Sink Power Connector

Callout 29, [Figure 1-2](#)

An active heat sink ([Figure 1-10](#)) is provided for the FPGA. A 12V fan is affixed to the heatsink and is powered from the 3-pin friction lock header J121 ([Figure 1-11](#)).

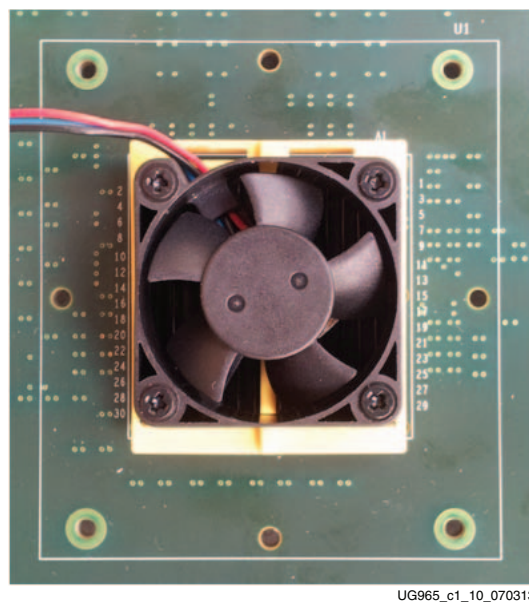

Figure 1-10: Active FPGA Heatsink

The fan power connections are detailed in [Table 1-5](#):

Table 1-5: Fan Power Connections

Fan Wire	Header Pin
Black	J121.1 - GND
Red	J121.2 - 12V
Blue	J121.3 - NC

[Figure 1-11](#) shows the heatsink fan power connector J121.

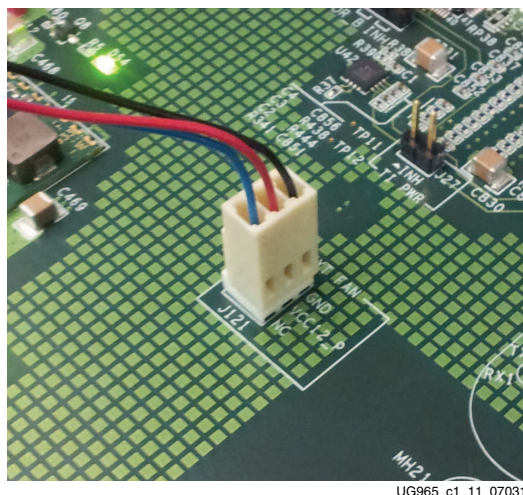

Figure 1-11: Heatsink Fan Power Connector J121

Virtex-7 FPGA

The VC7222 board is populated with the Virtex-7 XC7VH580T-G2HCG1155E FPGA at U1 (callout 1, [Figure 1-2](#)). For further information on Virtex-7 FPGAs, see *7 Series FPGAs Overview* (DS180) [[Ref 5](#)].

FPGA Configuration

The FPGA is configured via JTAG using one of the following options:

- USB JTAG connector (callout 9, [Figure 1-2](#))
- System ACE SD (callout 11, [Figure 1-2](#))
- JTAG cable connector (callout 10, [Figure 1-2](#))

The VC7222 board comes with an embedded USB-to-JTAG configuration module (U57) which allows a host computer to access the board JTAG chain using a standard A to micro-B USB cable. Alternately, the FPGA can be configured via System ACE from a Secure Digital (SD) memory card installed in J30 (see [System ACE SD Configuration Address DIP Switches](#), page 20). Finally, a JTAG connector (J1) is available to provide access to the JTAG chain using one of Xilinx's configuration cables—Platform Cable USB, Platform Cable USB II or Parallel Cable IV (PCIV).

The JTAG chain of the board is illustrated in Figure 1-12. By default only the Virtex-7 FPGA and the System ACE SD controller are part of the chain (J112 jumper OFF). Installing the J112 jumper adds the FMC interfaces as well.

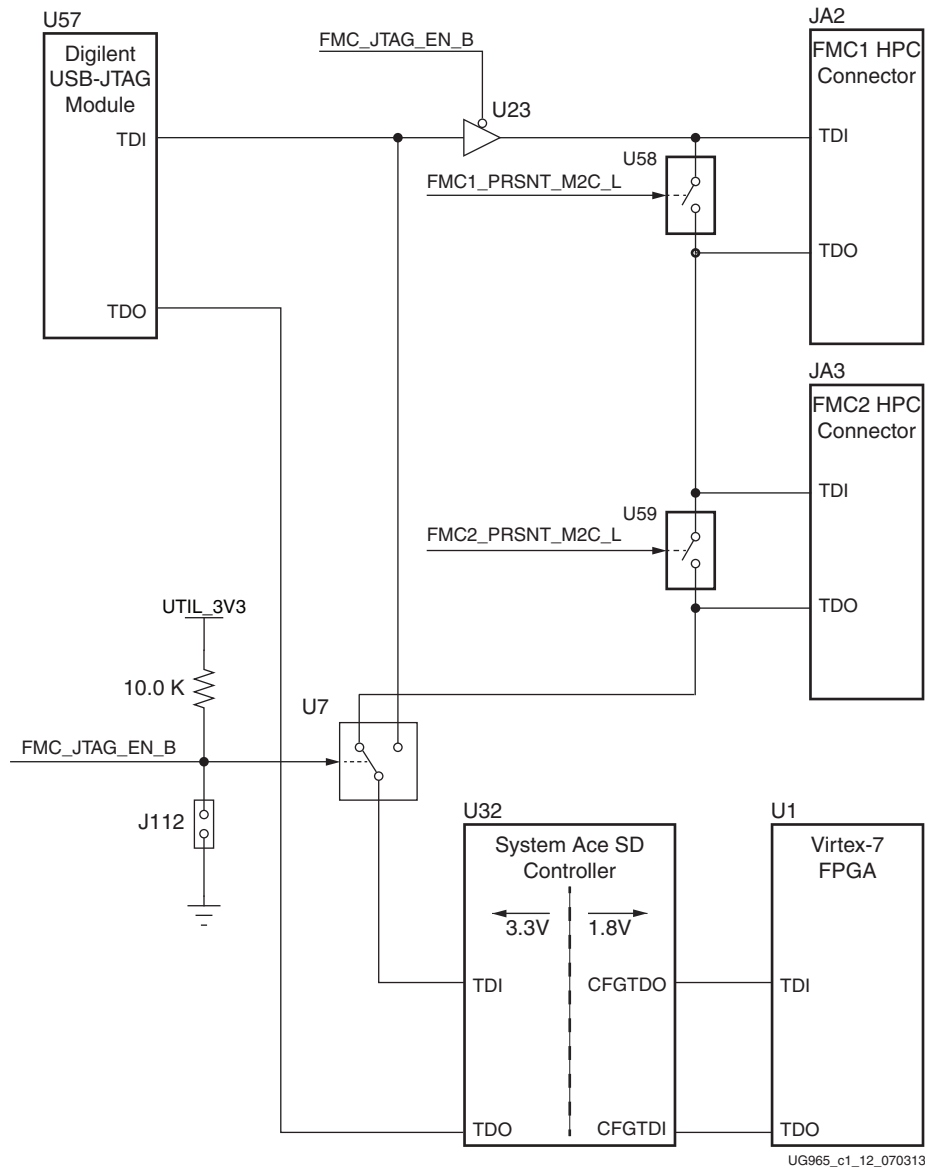

Figure 1-12: JTAG Chain

PROG_B Pushbutton

Pressing the PROG pushbutton SW3 (callout 18, Figure 1-2) grounds the active-Low program pin of the FPGA.

DONE LED

The DONE LED DS21 (callout 16, Figure 1-2) indicates the state of the DONE pin of the FPGA. When the DONE pin is High, DS21 lights indicating the FPGA is successfully configured.

INIT LED

The dual-color INIT LED DS25 (callout 17, [Figure 1-2](#)) indicates the FPGA initialization status. During FPGA initialization the INIT LED illuminates RED. When FPGA initialization has completed the LED illuminates GREEN.

System ACE SD Controller

The onboard System ACE SD controller U32 allows storage of multiple configuration files on a Secure Digital (SD) card. These configuration files can be used to program the FPGA. The SD card connects to the SD card connector J30 (callout 11, [Figure 1-2](#)) located directly below the System ACE SD controller on the back side of the board.

System ACE SD Controller Reset

Pressing the SASD RESET pushbutton SW7 (callout 13, [Figure 1-2](#)) resets the System ACE SD controller. The reset pin is an active-Low input.

System ACE SD Configuration Address DIP Switches

DIP switch SW8 shown in [Figure 1-13](#) selects one of the eight configuration bitstream addresses in the SD memory card. A switch is in the ON position if set to the far right and in the OFF position if set to the far left. The MODE bit (switch position 4) is not used and can be set either ON or OFF. SW8 is shown in [Figure 1-2](#) as callout 12.

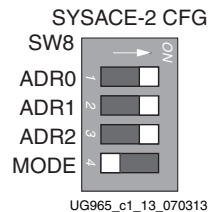

Figure 1-13: Configuration Address DIP Switch (SW8)

The switch settings for selecting each address are shown in [Table 1-6](#).

Table 1-6: SW8 DIP Switch Configuration

Configuration Bitstream Address	ADR2	ADR1	ADR0
0	ON	ON	ON
1	ON	ON	OFF
2	ON	OFF	ON
3	ON	OFF	OFF
4	OFF	ON	ON
5	OFF	ON	OFF
6	OFF	OFF	ON
7	OFF	OFF	OFF

200 MHz 2.5V LVDS Oscillator

U35 (callout 15, Figure 1-2).

The VC7222 board has one 200 MHz 2.5V LVDS oscillator (U35) connected to multi-region clock capable (MRCC) inputs on the FPGA. Table 1-7 lists the FPGA pin connections to the LVDS oscillator.

Table 1-7: LVDS Oscillator MRCC Connections

FPGA (U1)				Schematic Net Name	Device (U35)		
Pin	Function	Direction	IOSTANDARD		Pin	Function	Direction
AL24	SYSTEM CLOCK_P	Input	LVDS	LVDS_OSC_P	4	200 MHz LVDS oscillator	Output
AL25	SYSTEM CLOCK_N	Input	LVDS	LVDS_OSC_N	5	201 MHz LVDS oscillator	Output

Differential SMA MRCC Pin Inputs

Callout 36, Figure 1-2.

The VC7222 board provides two pairs of differential SMA transceiver clock inputs that can be used for connecting to an external function generator. The FPGA MRCC pins are connected to the SMA connectors as shown in Table 1-8.

Table 1-8: Differential SMA Clock Connections

FPGA (U1)				Schematic Net Name	SMA Connector
Pin	Function	Direction	IOSTANDARD		
AK32	USER CLOCK_1_P	Input	LVDS	CLK_DIFF_1_P	J99
AL32	USER CLOCK_1_N	Input	LVDS	CLK_DIFF_1_N	J100
AK3	USER CLOCK_2_P	Input	LVDS	CLK_DIFF_2_P	J98
AL3	USER CLOCK_2_N	Input	LVDS	CLK_DIFF_2_N	J101

SuperClock-2 Module

Callout 14, Figure 1-2.

The SuperClock-2 module connects to the clock module interface connector (J82) and provides a programmable, low-noise and low-jitter clock source for the VC7222 board. The clock module maps to FPGA I/O by way of 24 control pins, 3 LVDS pairs, 1 regional clock pair, and 1 reset pin. Table 1-9 shows the FPGA I/O mapping for the SuperClock-2 module interface. The VC7222 board also supplies UTIL_5V0, UTIL_3V3, UTIL_2V5 and VCCO_HP input power to the clock module interface.

Table 1-9: SuperClock-2 FPGA I/O Mapping

FPGA (U1)				Schematic Net Name	J82 Pin		
Pin	Function	Direction	IOSTANDARD		Pin	Function	Direction
AK8	Clock recovery	Input	LVDS	CM_LVDS1_P	1	Clock recovery	Output
AL8	Clock recovery	Input	LVDS	CM_LVDS1_N	3	Clock recovery	Output
AE6	Clock recovery	Input	LVDS	CM_LVDS2_P	9	Clock recovery	Output
AF5	Clock recovery	Input	LVDS	CM_LVDS2_N	11	Clock recovery	Output
AG1	Clock recovery	Output	LVDS	CM_LVDS3_P	17	Clock recovery	Input
AH1	Clock recovery	Output	LVDS	CM_LVDS3_N	19	Clock recovery	Input
AJ11	Regional clock	Input	LVDS	CM_GCLK_P	25	Global clock	Output
AJ10	Regional clock	Input	LVDS	CM_GCLK_N	27	Global clock	Output
AF8	Control I/O	In/Out	LVC MOS18	CM_CTRL_0	61	NC	-
AH9	Control I/O	In/Out	LVC MOS18	CM_CTRL_1	63	NC	-
AH8	Control I/O	In/Out	LVC MOS18	CM_CTRL_2	65	NC	-
AJ9	Control I/O	Output	LVC MOS18	CM_CTRL_3	67	DEC	Input
AJ8	Control I/O	Output	LVC MOS18	CM_CTRL_4	69	INC	Input
AM10	Control I/O	Output	LVC MOS18	CM_CTRL_5	71	ALIGN	Input
AM9	Control I/O	In/Out	LVC MOS18	CM_CTRL_6	73	NC	-
AF12	Control I/O	In/Out	LVC MOS18	CM_CTRL_7	75	NC	-
AF9	Control I/O	In/Out	LVC MOS18	CM_CTRL_8	77	NC	-
AG9	Control I/O	In/Out	LVC MOS18	CM_CTRL_9	79	LOL	
AG12	Control I/O	Output	LVC MOS18	CM_CTRL_10	81	INT_ALRM	Input
AH12	Control I/O	Output	LVC MOS18	CM_CTRL_11	83	C1B	Input
AP10	Control I/O	Output	LVC MOS18	CM_CTRL_12	85	C2B	Input
AP9	Control I/O	Output	LVC MOS18	CM_CTRL_13	87	C3B	Input
AK12	Control I/O	Output	LVC MOS18	CM_CTRL_14	89	C1A	Input
AL12	Control I/O	Output	LVC MOS18	CM_CTRL_15	91	C2A	Input
AN12	Control I/O	In/Out	LVC MOS18	CM_CTRL_16	93	NC	-
AN11	Control I/O	Output	LVC MOS18	CM_CTRL_17	95	CS0_C3A	Input
AN9	Control I/O	Output	LVC MOS18	CM_CTRL_18	97	CS1_C4A	Input

Table 1-9: SuperClock-2 FPGA I/O Mapping (Cont'd)

FPGA (U1)				Schematic Net Name	J82 Pin		
Pin	Function	Direction	IOSTANDARD		Pin	Function	Direction
AN8	Control I/O	In/Out	LVCMOS18	CM_CTRL_19	99	NC	-
AN13	Control I/O	In/Out	LVCMOS18	CM_CTRL_20	101	NC	-
AP13	Control I/O	In/Out	LVCMOS18	CM_CTRL_21	103	NC	-
AM12	Control I/O	In/Out	LVCMOS18	CM_CTRL_22	105	NC	-
AM11	Control I/O	In/Out	LVCMOS18	CM_CTRL_23	107	NC	-
AE8	CM_RESET	Output	LVCMOS18	CM_RST	66	RESET_B	Input

User LEDs (Active High)

Callout 30, Figure 1-2.

DS13 through DS20 are eight active-High LEDs that are connected to user I/O pins on the FPGA as shown in Table 1-10. These LEDs can be used to indicate status or any other purpose determined by the user.

Table 1-10: User LEDs

FPGA (U1)				Schematic Net Name	Reference Designator
Pin	Function	Direction	IOSTANDARD		
AH26	User LED	Output	LVCMOS18	APP_LED1	DS19
AJ26	User LED	Output	LVCMOS18	APP_LED2	DS20
AM25	User LED	Output	LVCMOS18	APP_LED3	DS17
AM26	User LED	Output	LVCMOS18	APP_LED4	DS18
AN26	User LED	Output	LVCMOS18	APP_LED5	DS16
AP26	User LED	Output	LVCMOS18	APP_LED6	DS15
AM24	User LED	Output	LVCMOS18	APP_LED7	DS13
AN24	User LED	Output	LVCMOS18	APP_LED8	DS14

User DIP Switches (Active High) and I/O Header

Callout 32, Figure 1-2.

The DIP switch SW2 provides a set of eight active-High switches that are connected to user I/O pins on the FPGA as shown in Table 1-11. These pins can be used to set control pins or any other purpose determined by the user. Six of the eight I/Os also map to 2 x 6 test header J125 providing external access for these pins (callout 33, Figure 1-2).

Table 1-11: User DIP Switches

FPGA (U1)				Schematic Net Name	SW2 DIP Switch Pin	J125 Test Header Pin
Pin	Function	Direction	IOSTANDARD			
AD26	User switch	Input	LVCMOS18	USER_SW1	1	2
AE26	User switch	Input	LVCMOS18	USER_SW2	2	4
AC26	User switch	Input	LVCMOS18	USER_SW3	3	6
AC27	User switch	Input	LVCMOS18	USER_SW4	4	8
AE27	User switch	Input	LVCMOS18	USER_SW5	5	10
AF27	User switch	Input	LVCMOS18	USER_SW6	6	12
AG27	User switch	Input	LVCMOS18	USER_SW7	7	-
AH27	User switch	Input	LVCMOS18	USER_SW8	8	-

Figure 1-14 Shows the user test I/O connector J125 (Callout 26, Figure 1-2).

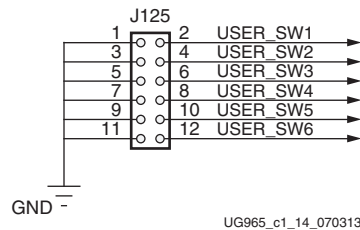

Figure 1-14: User Test I/O

User Pushbuttons (Active High)

Callout 31, Figure 1-2.

SW4 and SW5 are active-High user pushbuttons that are connected to user I/O pins on the FPGA as shown in Table 1-12. These switches can be used for any purpose determined by the user.

Table 1-12: User Pushbuttons

FPGA (U1)				Schematic Net Name	Reference Designator
Pin	Function	Direction	IOSTANDARD		
AL22	User pushbutton	Input	LVCMOS18	USER_PB1	SW5
AM22	User pushbutton	Input	LVCMOS18	USER_PB2	SW4

GTH Transceivers and Reference Clocks

Callout 6, Figure 1-2.

The VC7222 board provides access to all GTH transceiver and reference clock pins on the FPGA as shown in Figure 1-15. The GTH transceivers are grouped into six sets of four RX-TX lanes. Four lanes are referred to as a *Quad*.

Note: Figure 1-15 is for reference only and might not reflect the current revision of the board.

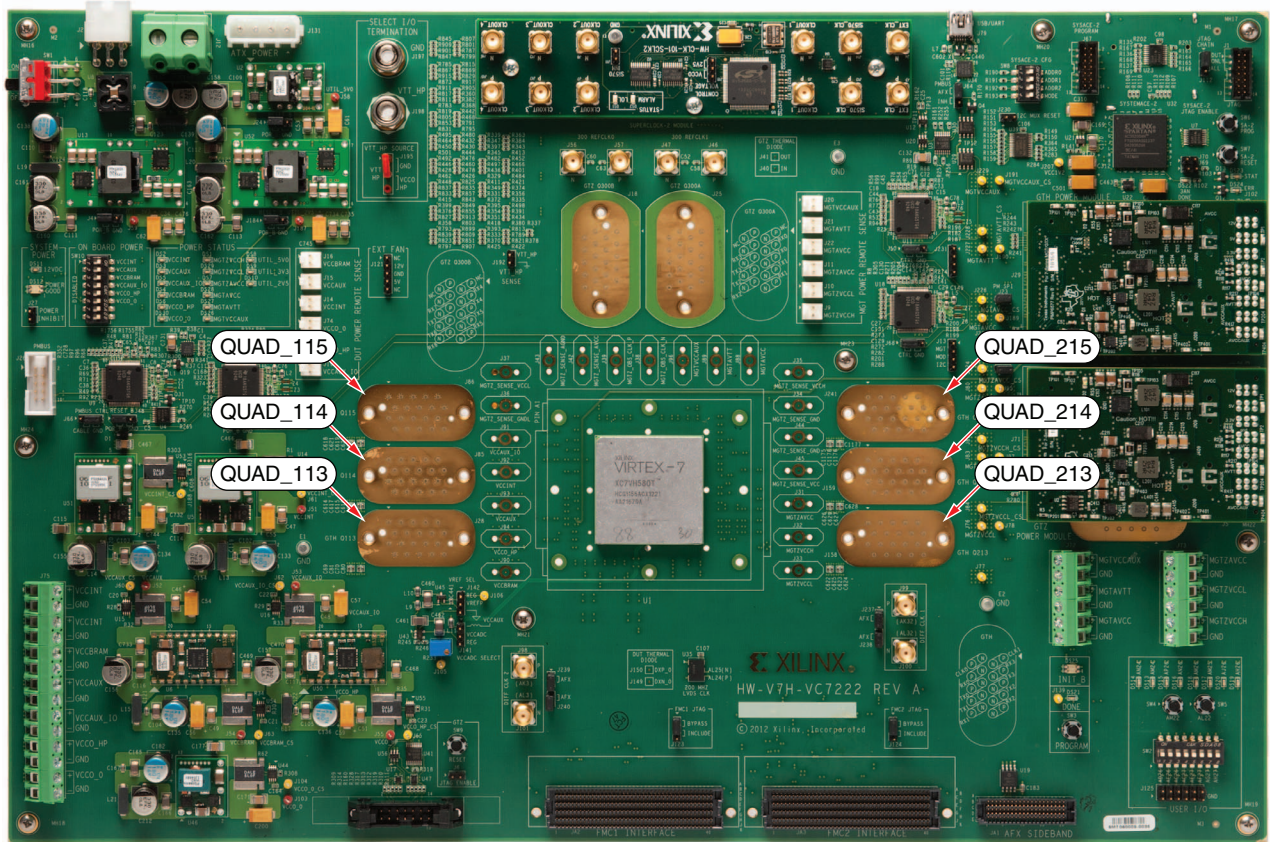

UG965_ct_15_070313

Figure 1-15: GTH Quad Locations

Each GTH Quad and its associated reference clocks (CLK0 and CLK1) are brought out to a connector pad which interfaces with Samtec BullsEye connectors used with the Samtec HDR-155805-01-BEYE cable assembly. Contact Samtec, Inc. for information about this or other cable assemblies. [Figure 1-16 A](#) shows the connector pad. [Figure 1-16 B](#) shows the connector pinout.

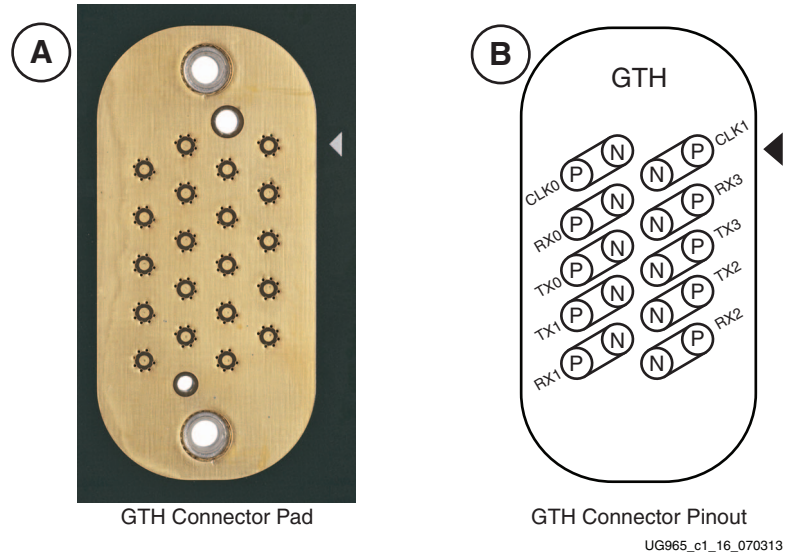

Figure 1-16: A – GTH Connector Pad. B – GTH Connector Pinout

Information for each GTH transceiver pin is shown in [Table 1-13](#).

Table 1-13: GTH Transceiver Pins

FPGA (U1) Pin	Net Name	Quad	Connector	Trace Length (mils)
AC2	113_TX0_P	113	J28	2,831
AC1	113_TX0_N	113	J28	2,833
Y4	113_RX0_P	113	J28	3,115
Y3	113_RX0_N	113	J28	3,118
AA2	113_TX1_P	113	J28	2,554
AA1	113_TX1_N	113	J28	2,554
AD4	113_RX1_P	113	J28	2,447
AD3	113_RX1_N	113	J28	2,448
W2	113_TX2_P	113	J28	2,472
W1	113_TX2_N	113	J28	2,472
AB4	113_RX2_P	113	J28	2,365
AB3	113_RX2_N	113	J28	2,365
U2	113_TX3_P	113	J28	2,768
U1	113_TX3_N	113	J28	2,763

Table 1-13: GTH Transceiver Pins (Cont'd)

FPGA (U1) Pin	Net Name	Quad	Connector	Trace Length (mils)
V4	113_RX3_P	113	J28	2,983
V3	113_RX3_N	113	J28	2,982
R2	114_TX0_P	114	J85	2,665
R1	114_TX0_N	114	J85	2,667
T4	114_RX0_P	114	J85	2,893
T3	114_RX0_N	114	J85	2,897
N2	114_TX1_P	114	J85	2,353
N1	114_TX1_N	114	J85	2,353
P4	114_RX1_P	114	J85	2,279
P3	114_RX1_N	114	J85	2,280
L2	114_TX2_P	114	J85	2,329
L1	114_TX2_N	114	J85	2,329
K4	114_RX2_P	114	J85	2,331
K3	114_RX2_N	114	J85	2,332
J2	114_TX3_P	114	J85	2,632
J1	114_TX3_N	114	J85	2,634
M4	114_RX3_P	114	J85	2,935
M3	114_RX3_N	114	J85	2,931
G2	115_TX0_P	115	J86	2,728
G1	115_TX0_N	115	J86	2,726
H4	115_RX0_P	115	J86	2,957
H3	115_RX0_N	115	J86	2,958
E2	115_TX1_P	115	J86	2,448
E1	115_TX1_N	115	J86	2,448
F4	115_RX1_P	115	J86	2,406
F3	115_RX1_N	115	J86	2,407
C2	115_TX2_P	115	J86	2,530
C1	115_TX2_N	115	J86	2,530
D4	115_RX2_P	115	J86	2,489
D3	115_RX2_N	115	J86	2,489
A2	115_TX3_P	115	J86	2,826
A1	115_TX3_N	115	J86	2,825

Table 1-13: GTH Transceiver Pins (Cont'd)

FPGA (U1) Pin	Net Name	Quad	Connector	Trace Length (mils)
B4	115_RX3_P	115	J86	3,092
B3	115_RX3_N	115	J86	3,091
AC33	213_TX0_P	213	J158	2,854
AC34	213_TX0_N	213	J158	2,855
Y31	213_RX0_P	213	J158	2,915
Y32	213_RX0_N	213	J158	2,914
AA33	213_TX1_P	213	J158	3,111
AA34	213_TX1_N	213	J158	3,111
AD31	213_RX1_P	213	J158	3,477
AD32	213_RX1_N	213	J158	3,473
W33	213_TX2_P	213	J158	3,163
W34	213_TX2_N	213	J158	3,164
AB31	213_RX2_P	213	J158	3,641
AB32	213_RX2_N	213	J158	3,641
U33	213_TX3_P	213	J158	2,965
U34	213_TX3_N	213	J158	2,961
V31	213_RX3_P	213	J158	2,798
V32	213_RX3_N	213	J158	2,796
R33	214_TX0_P	214	J159	2,709
R34	214_TX0_N	214	J159	2,709
T31	214_RX0_P	214	J159	2,624
T32	214_RX0_N	214	J159	2,624
N33	214_TX1_P	214	J159	2,919
N34	214_TX1_N	214	J159	2,919
P31	214_RX1_P	214	J159	3,212
P32	214_RX1_N	214	J159	3,212
L33	214_TX2_P	214	J159	3,037
L34	214_TX2_N	214	J159	3,039
K31	214_RX2_P	214	J159	3,200
K32	214_RX2_N	214	J159	3,203
J33	214_TX3_P	214	J159	2,667
J34	214_TX3_N	214	J159	2,667

Table 1-13: GTH Transceiver Pins (Cont'd)

FPGA (U1) Pin	Net Name	Quad	Connector	Trace Length (mils)
M31	214_RX3_P	214	J159	2,636
M32	214_RX3_N	214	J159	2,638
G33	215_TX0_P	215	J241	2,804
G34	215_TX0_N	215	J241	2,804
H31	215_RX0_P	215	J241	2,784
H32	215_RX0_N	215	J241	2,786
E33	215_TX1_P	215	J241	3,122
E34	215_TX1_N	215	J241	3,118
F31	215_RX1_P	215	J241	3,203
F32	215_RX1_N	215	J241	3,204
C33	215_TX2_P	215	J241	3,072
C34	215_TX2_N	215	J241	3,070
D31	215_RX2_P	215	J241	3,342
D32	215_RX2_N	215	J241	3,342
A33	215_TX3_P	215	J241	2,821
A34	215_TX3_N	215	J241	2,821
B31	215_RX3_P	215	J241	2,780
B32	215_RX3_N	215	J241	2,781

Information for each GTH transceiver clock input is shown in [Table 1-14](#).

Table 1-14: GTH Transceiver Reference Clock Inputs

FPGA (U1) Pin	Net Name	Quad	Connector
AC6	113_REFCLK0_P	113	J28
AC5	113_REFCLK0_N	113	J28
AA6	113_REFCLK1_P	113	J28
AA5	113_REFCLK1_N	113	J28
W6	114_REFCLK0_P	114	J85
W5	114_REFCLK0_N	114	J85
U6	114_REFCLK1_P	114	J85
U5	114_REFCLK1_N	114	J85
N6	115_REFCLK0_P	115	J86
N5	115_REFCLK0_N	115	J86
R6	115_REFCLK1_P	115	J86

Table 1-14: GTH Transceiver Reference Clock Inputs (Cont'd)

FPGA (U1) Pin	Net Name	Quad	Connector
R5	115_REFCLK1_N	115	J86
AC29	213_REFCLK0_P	213	J158
AC30	213_REFCLK0_N	213	J158
AA29	213_REFCLK1_P	213	J158
AA30	213_REFCLK1_N	213	J158
W29	214_REFCLK0_P	214	J159
W30	214_REFCLK0_N	214	J159
U29	214_REFCLK1_P	214	J159
U30	214_REFCLK1_N	214	J159
N29	215_REFCLK0_P	215	J241
N30	215_REFCLK0_N	215	J241
R29	215_REFCLK1_P	215	J241
R30	215_REFCLK1_N	215	J241

GTZ Transceivers and Reference Clocks

Callout 7, Figure 1-2.

The VC7222 board provides access to all GTZ transceiver and reference clock pins on the FPGA as shown in Figure 1-17. The GTZ transceivers are grouped into one set of eight RX-TX lanes. Eight lanes are referred to as an *Octal*.

Note: Figure 1-17 is for reference only and might not reflect the current revision of the board.

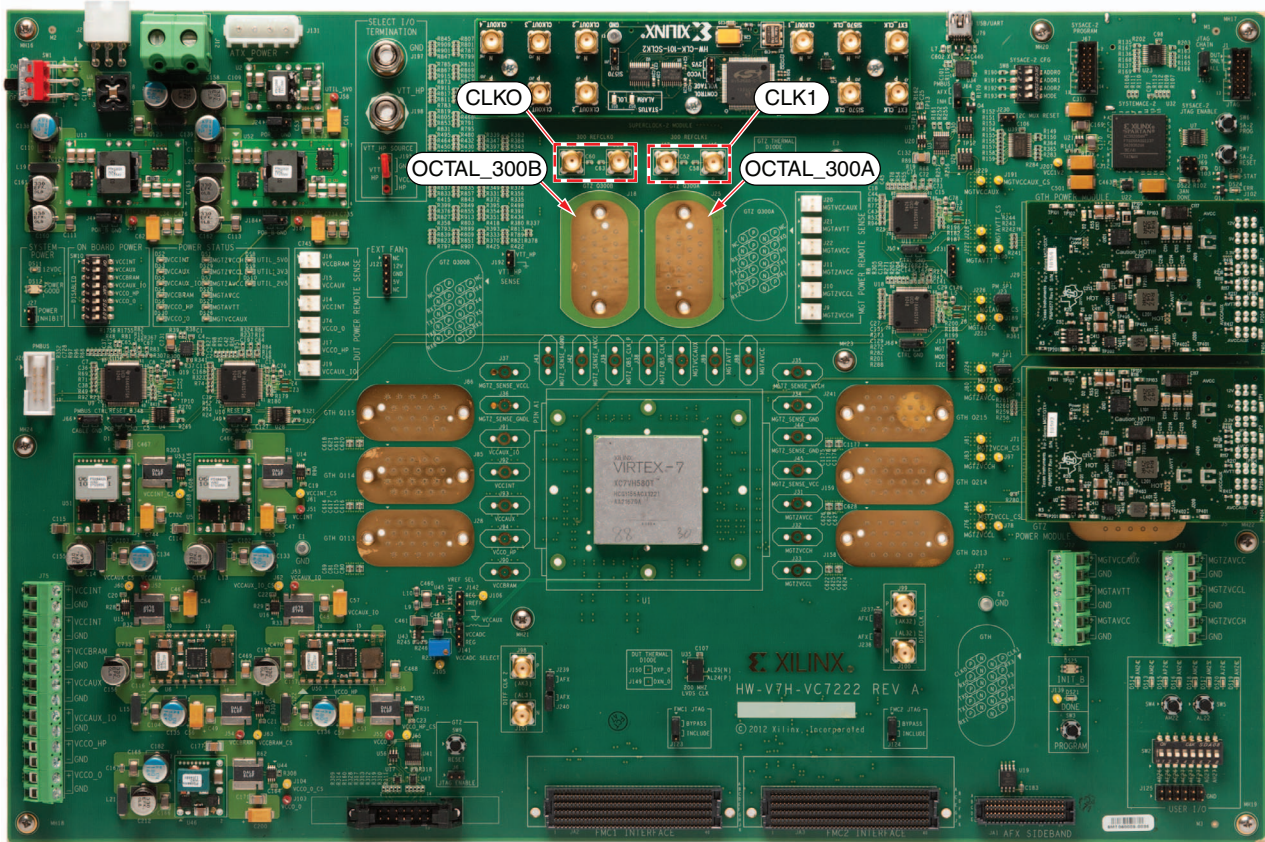

UG965_ct_17_010212

Figure 1-17: GTZ Quad Locations

The GTZ Octal is brought out to two connector pads (J18, J25) which interface with Samtec BullsEye connectors used with the Samtec HDR-155805-01-BEYE cable assembly. Contact Samtec, Inc. for information about this or other cable assemblies. [Figure 1-18 A](#) shows the J18 connector pad (the J25 connector pad is identical). [Figure 1-18 B](#) shows the 300A connector pinout. [Figure 1-18 C](#) shows the 300B connector pinout.

The GTZ reference clocks (CLK0 and CLK1) are brought out to two pairs of SMA connectors as shown in [Figure 1-17](#).

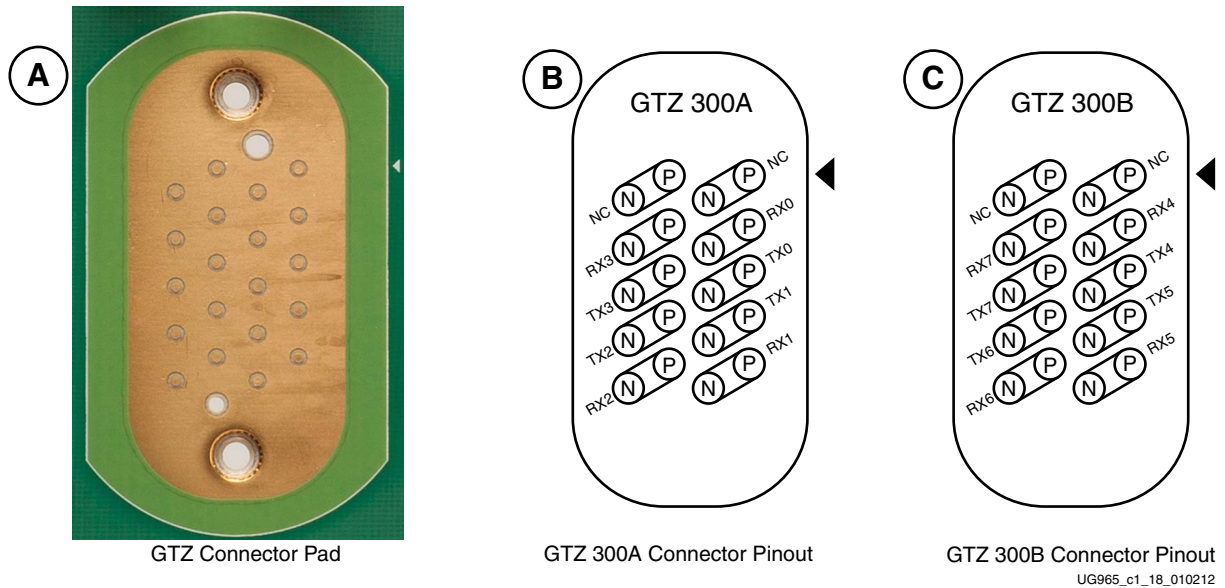

Figure 1-18: A – GTZ Connector Pad. B – GTZ 300A Connector Pinout C – GTZ 300B Connector Pinout

Information for each GTZ transceiver pin is shown in [Table 1-15](#).

Table 1-15: GTZ Transceiver Pins

FPGA (U1) Pin	Net Name	Octal	Connector	Trace Length (mils)
C29	300_TX0_P	300A	J25	2,723
C28	300_TX0_N	300A	J25	2,723
C23	300_RX0_P	300A	J25	2,953
C22	300_RX0_N	300A	J25	2,953
A28	300_TX1_P	300A	J25	2,332
A27	300_TX1_N	300A	J25	2,332
A22	300_RX1_P	300A	J25	2,252
A21	300_RX1_N	300A	J25	2,252
C26	300_TX2_P	300A	J25	2,338
C25	300_TX2_N	300A	J25	2,337
C20	300_RX2_P	300A	J25	2,250
C19	300_RX2_N	300A	J25	2,250

Table 1-15: GTZ Transceiver Pins (Cont'd)

FPGA (U1) Pin	Net Name	Octal	Connector	Trace Length (mils)
A25	300_TX3_P	300A	J25	2,540
A24	300_TX3_N	300A	J25	2,540
A19	300_RX3_P	300A	J25	2,696
A18	300_RX3_N	300A	J25	2,696
C17	300_TX4_P	300B	J18	2,738
C16	300_TX4_N	300B	J18	2,737
C11	300_RX4_P	300B	J18	2,776
C10	300_RX4_N	300B	J18	2,776
A16	300_TX5_P	300B	J18	2,412
A15	300_TX5_N	300B	J18	2,412
A10	300_RX5_P	300B	J18	2,181
A9	300_RX5_N	300B	J18	2,181
C14	300_TX6_P	300B	J18	2,646
C13	300_TX6_N	300B	J18	2,645
C8	300_RX6_P	300B	J18	2,311
C7	300_RX6_N	300B	J18	2,311
A13	300_TX7_P	300B	J18	2,844
A12	300_TX7_N	300B	J18	2,844
A7	300_RX7_P	300B	J18	2,839
A6	300_RX7_N	300B	J18	2,839

Information for each GTZ transceiver clock input is shown in [Table 1-16](#).

Table 1-16: GTZ Transceiver Reference Clock Inputs

FPGA (U1) Pin	Net Name	SMA Connector
E17	300_REFCLK0_P	J57
E16	300_REFCLK0_N	J56
E21	300_REFCLK1_P	J46
E20	300_REFCLK1_N	J47

USB-to-UART Bridge

Callout 28, Figure 1-2.

A USB-to-UART bridge (U34, Silicon Laboratories CP2103) is provided for serial communication between a host computer and the FPGA over a USB cable. The USB connector on the board is a mini-B receptacle (J79) and its pinout is shown in Table 1-17.

Table 1-17: USB Mini-B Receptacle Pin Assignments and Signals

J79 Pin	Signal Name	Description
1	VBUS	+5V into the CP2103 USB-to-UART bridge at U34. Used to sense USB network connection.
2	USB_DATA_N	Bidirectional differential serial data (N-side).
3	USB_DATA_P	Bidirectional differential serial data (P-side).
4	GROUND	Signal ground.

The CP2103 supports an IO voltage range of 1.8V to 3.3V. Xilinx UART IP is expected to be implemented in the FPGA fabric. The FPGA supports the USB-to-UART bridge using four signal pins:

- Transmit (TX)
- Receive (RX)
- Request to Send (RTS)
- Clear to Send (CTS)

Connections of these signals between the FPGA and the CP2103 are listed in Table 1-18.

Table 1-18: FPGA to UART Connections

FPGA (U1)				Schematic Net Name	Device (U34)		
Pin	Function	Direction	IOSTANDARD		Pin	Function	Direction
AG11	RTS	Output	LVC MOS18	USB_CTS_I_B	22	CTS	Input
AL9	CTS	Input	LVC MOS18	USB_RTS_0_B	23	RTS	Output
AL10	TX	Output	LVC MOS18	USB_RXD_I	24	RXD	Input
AK10	RX	Input	LVC MOS18	USB_TXD_0	25	TXD	Output

The bridge device also provides as many as 4 GPIO signals that can be defined by the user for status and control information (Table 1-19).

Table 1-19: CP2103 USB-to-UART Bridge User GPIO

FPGA (U1)				Schematic Net Name	Device (U34)		
Pin	Function	Direction	IOSTANDARD		Pin	Function	Direction
AD10	SelectIO	In/Out	LVC MOS18	USB_GPIO_0	19	GPIO	In/Out
AC8	SelectIO	In/Out	LVC MOS18	USB_GPIO_1	18	GPIO	In/Out
AD8	SelectIO	In/Out	LVC MOS18	USB_GPIO_2	17	GPIO	In/Out
AK11	SelectIO	In/Out	LVC MOS18	USB_GPIO_3	16	GPIO	In/Out

A royalty-free software driver named Virtual COM Port (VCP) is available from Silicon Laboratories. This driver permits the CP2103 USB-to-UART bridge to appear as a COM port to the host computer communications application software (for example, HyperTerminal or TeraTerm). The VCP driver must be installed on the host computer prior to establishing communications with the VC7222 board.

FPGA Mezzanine Card HPC Interface

Callout 34 and 35, Figure 1-2.

The VC7222 board features two high pin count (HPC) connectors as defined by the VITA 57.1 FPGA Mezzanine card (FMC) specification. The FMC HPC connector is a 10 x 40 position socket. See [Appendix B, VITA 57.1 FMC Connector Pinouts](#) for a cross-reference of signal names to pin coordinates.

FMC1 HPC connector JA2 provides connectivity for:

- 34 differential user defined pairs:
 - 34 LA pairs
- 4 differential clocks

FMC2 HPC connector JA3 provides connectivity for:

- 57 differential user defined pairs:
 - 34 LA pairs
 - 12 HA pairs
 - 11 HB pairs
- 2 differential clocks

Note: The V_{ADJ} voltage on the three FMC HPC connectors tracks VCCO_HP.

The FMC HPC connectors on the VC7222 board are identified as FMC1 at JA2 and FMC2 at JA3. The connections for each of these connectors are listed in [Table 1-20](#) and [Table 1-21](#), respectively.

Table 1-20: VITA 57.1 FMC1 HPC Connections at JA2

FPGA (U1) Pin	Net Name	FMC Pin
AK2	FMC1_CLK0_M2C_P	H4
AL2	FMC1_CLK0_M2C_N	H5
AJ15	FMC1_CLK1_M2C_P	G2
AK15	FMC1_CLK1_M2C_N	G3
AK3	FMC1_CLK2_BIDIR_P ⁽¹⁾	K4
AL3	FMC1_CLK2_BIDIR_N ⁽¹⁾	K5
AL15	FMC1_CLK3_BIDIR_P	J2
AL14	FMC1_CLK3_BIDIR_N	J3
AJ5	FMC1_LA00_CC_P ⁽¹⁾	G6
AK5	FMC1_LA00_CC_N	G7
AJ4	FMC1_LA01_CC_P	D8

Table 1-20: VITA 57.1 FMC1 HPC Connections at JA2 (Cont'd)

FPGA (U1) Pin	Net Name	FMC Pin
AJ3	FMC1_LA01_CC_N	D9
AG6	FMC1_LA02_P	H7
AG5	FMC1_LA02_N	H8
AH6	FMC1_LA03_P	G9
AJ6	FMC1_LA03_N	G10
AG7	FMC1_LA04_P	H10
AH7	FMC1_LA04_N	H11
AE7	FMC1_LA05_P	D11
AF7	FMC1_LA05_N	D12
AK7	FMC1_LA06_P	C10
AK6	FMC1_LA06_N	C11
AF4	FMC1_LA07_P	H13
AG4	FMC1_LA07_N	H14
AH4	FMC1_LA08_P	G12
AH3	FMC1_LA08_N	G13
AG2	FMC1_LA09_P	D14
AH2	FMC1_LA09_N	D15
AM2	FMC1_LA10_P	C14
AN2	FMC1_LA10_N	C15
AM1	FMC1_LA11_P	H16
AN1	FMC1_LA11_N	H17
AJ1	FMC1_LA12_P	G15
AK1	FMC1_LA12_N	G16
AN3	FMC1_LA13_P	D17
AP3	FMC1_LA13_N	D18
AM6	FMC1_LA14_P	C18
AM5	FMC1_LA14_N	C19
AL7	FMC1_LA15_P	H19
AM7	FMC1_LA15_N	H20
AM4	FMC1_LA16_P	G18
AN4	FMC1_LA16_N	G19
AM16	FMC1_LA17_CC_P	D20
AM15	FMC1_LA17_CC_N	D21

Table 1-20: VITA 57.1 FMC1 HPC Connections at JA2 (Cont'd)

FPGA (U1) Pin	Net Name	FMC Pin
AM14	FMC1_LA18_CC_P	C22
AN14	FMC1_LA18_CC_N	C23
AB17	FMC1_LA19_P	H22
AC17	FMC1_LA19_N	H23
AG17	FMC1_LA20_P	G21
AH17	FMC1_LA20_N	G22
AD16	FMC1_LA21_P	H25
AE16	FMC1_LA21_N	H26
AB16	FMC1_LA22_P	G24
AC16	FMC1_LA22_N	G25
AE17	FMC1_LA23_P	D23
AF17	FMC1_LA23_N	D24
AG16	FMC1_LA24_P	H28
AH16	FMC1_LA24_N	H29
AK17	FMC1_LA25_P	G27
AL17	FMC1_LA25_N	G28
AN16	FMC1_LA26_P	D26
AP16	FMC1_LA26_N	D27
AM17	FMC1_LA27_P	C26
AN17	FMC1_LA27_N	C27
AP15	FMC1_LA28_P	H31
AP14	FMC1_LA28_N	H32
AJ16	FMC1_LA29_P	G30
AK16	FMC1_LA29_N	G31
AD15	FMC1_LA30_P	H34
AE15	FMC1_LA30_N	H35
AK13	FMC1_LA31_P	G33
AL13	FMC1_LA31_N	G34
AF15	FMC1_LA32_P	H37
AG15	FMC1_LA32_N	H38
AH14	FMC1_LA33_P	G36

Table 1-20: VITA 57.1 FMC1 HPC Connections at JA2 (Cont'd)

FPGA (U1) Pin	Net Name	FMC Pin
AJ14	FMC1_LA33_N	G37
AP1	FMC1_PRSNT_M2C_L	H2

Notes:

1. This signal is connected to additional components and is not recommended for critical signals. See the VC7222 schematic for additional information.

Table 1-21: VITA 57.1 FMC2 HPC Connections at JA3

FPGA (U1) Pin	Net Name	FMC Pin
AH31	FMC2_CLK0_M2C_P	H4 ⁽¹⁾
AJ31	FMC2_CLK0_M2C_N	H5 ⁽¹⁾
AK33	FMC2_CLK1_M2C_P	G2
AL33	FMC2_CLK1_M2C_N	G3
AK32	FMC2_LA00_CC_P	G6 ⁽¹⁾
AL32	FMC2_LA00_CC_N	G7 ⁽¹⁾
AK30	FMC2_LA01_CC_P	D8
AK31	FMC2_LA01_CC_N	D9
AE28	FMC2_LA02_P	H7
AF28	FMC2_LA02_N	H8
AJ29	FMC2_LA03_P	G9
AJ30	FMC2_LA03_N	G10
AF29	FMC2_LA04_P	H10
AG29	FMC2_LA04_N	H11
AH28	FMC2_LA05_P	D11
AH29	FMC2_LA05_N	D12
AJ28	FMC2_LA06_P	C10
AK28	FMC2_LA06_N	C11
AL28	FMC2_LA07_P	H13
AL29	FMC2_LA07_N	H14
AF30	FMC2_LA08_P	G12
AG30	FMC2_LA08_N	G13
AG31	FMC2_LA09_P	D14
AG32	FMC2_LA09_N	D15
AH32	FMC2_LA10_P	C14 ⁽¹⁾
AH33	FMC2_LA10_N	C15

Table 1-21: VITA 57.1 FMC2 HPC Connections at JA3 (Cont'd)

FPGA (U1) Pin	Net Name	FMC Pin
AG34	FMC2_LA11_P	H16
AH34	FMC2_LA11_N	H17
AM32	FMC2_LA12_P	G15 ⁽¹⁾
AN32	FMC2_LA12_N	G16
AL34	FMC2_LA13_P	D17
AM34	FMC2_LA13_N	D18
AJ33	FMC2_LA14_P	C18
AJ34	FMC2_LA14_N	C19
AN33	FMC2_LA15_P	H19
AP33	FMC2_LA15_N	H20
AM29	FMC2_LA16_P	G18
AN29	FMC2_LA16_N	G19
AJ20	FMC2_LA17_CC_P	D20
AK20	FMC2_LA17_CC_N	D21
AA20	FMC2_LA18_CC_P	C22
AB20	FMC2_LA18_CC_N	C23
AF19	FMC2_LA19_P	H22
AG19	FMC2_LA19_N	H23
AK18	FMC2_LA20_P	G21
AL18	FMC2_LA20_N	G22
AP20	FMC2_LA21_P	H25
AP21	FMC2_LA21_N	H26
AN19	FMC2_LA22_P	G24
AP19	FMC2_LA22_N	G25
AN18	FMC2_LA23_P	D23
AP18	FMC2_LA23_N	D24
AJ18	FMC2_LA24_P	H28
AJ19	FMC2_LA24_N	H29
AD20	FMC2_LA25_P	G27
AE20	FMC2_LA25_N	G28
AH21	FMC2_LA26_P	D26
AJ21	FMC2_LA26_N	D27
AF20	FMC2_LA27_P	C26

Table 1-21: VITA 57.1 FMC2 HPC Connections at JA3 (Cont'd)

FPGA (U1) Pin	Net Name	FMC Pin
AG20	FMC2_LA27_N	C27
AK21	FMC2_LA28_P	H31
AK22	FMC2_LA28_N	H32
AB21	FMC2_LA29_P	G30
AC21	FMC2_LA29_N	G31
AD21	FMC2_LA30_P	H34
AE21	FMC2_LA30_N	H35
AB22	FMC2_LA31_P	G33
AC22	FMC2_LA31_N	G34
AG22	FMC2_LA32_P	H37
AH22	FMC2_LA32_N	H38
AE22	FMC2_LA33_P	G36
AF22	FMC2_LA33_N	G37
AM19	FMC2_HA00_CC_P	F4
AM20	FMC2_HA00_CC_N	F5
AM21	FMC2_HA01_CC_P	E2
AN21	FMC2_HA01_CC_N	E3
AC18	FMC2_HA02_P	K7
AD18	FMC2_HA02_N	K8
AH18	FMC2_HA03_P	J6
AH19	FMC2_HA03_N	J7
AC19	FMC2_HA04_P	F7
AD19	FMC2_HA04_N	F8
AE18	FMC2_HA05_P	E6
AF18	FMC2_HA05_N	E7
AK26	FMC2_HA06_P	K10
AK27	FMC2_HA06_N	K11
AE23	FMC2_HA07_P	J9
AF23	FMC2_HA07_N	J10
AP24	FMC2_HA08_P	F10
AP25	FMC2_HA08_N	F11
AK23	FMC2_HA09_P	E9
AL23	FMC2_HA09_N	E10

Table 1-21: VITA 57.1 FMC2 HPC Connections at JA3 (Cont'd)

FPGA (U1) Pin	Net Name	FMC Pin
AN23	FMC2_HA10_P	K13
AP23	FMC2_HA10_N	K14
AL19	FMC2_HA17_CC_P	K16
AL20	FMC2_HA17_CC_N	K17
AH24	FMC2_HB00_CC_P	K25
AJ24	FMC2_HB00_CC_N	K26
AC23	FMC2_HB01_P	J24
AD23	FMC2_HB01_N	J25
AD24	FMC2_HB02_P	F22
AD25	FMC2_HB02_N	F23
AB24	FMC2_HB03_P	E21
AC24	FMC2_HB03_N	E22
AM27	FMC2_HB04_P	F25
AN27	FMC2_HB04_N	F26
AL30	FMC2_HB05_P	E24 ⁽¹⁾
AM30	FMC2_HB05_N	E25
AJ25	FMC2_HB06_CC_P	K28
AK25	FMC2_HB06_CC_N	K29
AP29	FMC2_HB07_P	J27
AP30	FMC2_HB07_N	J28
AM31	FMC2_HB08_P	F28
AN31	FMC2_HB08_N	F29
AN28	FMC2_HB09_P	E27
AP28	FMC2_HB09_N	E28
AG25	FMC2_HB17_CC_P	K37
AG26	FMC2_HB17_CC_N	K38
AN34	FMC2_PRSNT_M2C_L	H2

Notes:

1. This signal is connected to additional components and is not recommended for critical signals. See the VC7222 schematic for additional information.

XADC

Callout 37, Figure 1-2.

The 7 series FPGAs provide an Analog Front End (XADC) block. The XADC block includes a dual 12-bit, 1 MSPS Analog-to-Digital Converter (ADC) and on-chip sensors. See *7 Series FPGAs and Zynq-7000 All Programmable SoC XADC Dual 12-Bit 1 MSPS Analog-to-Digital Converter User Guide* (UG480) [Ref 1] for details on the capabilities of the analog front end.

The VC7222 board provides two options for providing power (VCCADC) to the analog circuitry in the XADC. Either option can be selected by placing a shunt in one of two positions on the 3-pin VCCADC SELECT header, J141 (callout 31, Figure 1-2):

- **Pins 1-2 (VCCAUX):** In this configuration VCCADC is provided from VCCAUX through a low pass filter network.
- **Pin 2-3 (REG):** In this configuration VCCADC is provided by an onboard regulator, U43 (Analog Devices P/N ADP123AUJZ-R7). The output voltage of the regulator VCCADC can be adjusted using the potentiometer R233.

In addition, the VC7222 board provides two options for providing the reference voltage for the analog-to-digital converter. Either option can be selected by placing a shunt in one of two positions on the 3-pin VREF SEL header J142 (callout 31, Figure 1-2):

- **Pins 1-2 (REG):** In this configuration the ADC reference voltage is provided by an onboard, low-temperature coefficient 1.25V reference, U45 (Texas Instruments P/N REF3012AIDBZT)
- **Pin 2-3 (AGND):** In this configuration the VREFP on XADC is connected to analog ground and the ADC uses an on-chip reference.

I2C Bus Management

The I2C bus is controlled through U39, an 8-channel I2C-bus multiplexer (NXP Semiconductor PCA9547). The FPGA communicates with the multiplexer through I2C data and clock signals mapped to FPGA pins AG24 and AF24, respectively. The I2C idcode for the PCA9547 device is 0x70. The bus hosts four components:

- SuperClock-2 module
- 7 series GTH transceiver power supply module
- 7 series GTZ transceiver power supply module
- FMC1
- FMC2

An I2C component can be accessed by selecting the appropriate channel through the control register of the MUX as shown in Table 1-22.

Table 1-22: I2C Channel Assignments

U39 Channel	I2C Component
0	SuperClock-2 module
1	7 series GTH transceiver power supply module
2	FMC1
3	FMC2
4	7 series GTZ transceiver power supply module

Default Jumper and Switch Settings

Table A-1 lists the jumpers that must be installed on the VC7222 board for proper operation. These jumpers must be installed except where specifically noted in this user guide.

Note: Any jumper not listed in Table A-1 should be left open for normal operation.

Table A-1: Default Jumper Settings

Reference Designator	Name	Board Location	Jumper	Comments
J4	UTIL_3V3	Upper Left	AFX (1-2)	
J184	UTIL_2V5	Upper Left	AFX (1-2)	
J24	UTIL_5V0	Upper Left	AFX (1-2)	
J66	PMBUS CTRL	Center Left	GND (2-3)	
J48		Center Left	POR (1-2)	
J49		Center Left	POR (1-2)	
J50		Upper Right	POR (1-2)	
J68		Center Right	POR (1-2)	
J141	VCCADC SELECT	Lower Left	VCCAUX (1-2)	
J142	VREF SEL	Lower Left	REG (1-2)	
J23	SPI LVL TRNS INH	Upper Right	Installed	
J8	SPI LVL TRNS INH	Center Right	Installed	
J195	VTT_HP SOURCE	Center Right	GND (1-2)	Red 20A jumper

DIP switch SW10 enables the supply of onboard core power to the FPGA. For normal operation positions 1 through 6 must be set to the ON position as shown in Figure A-1.

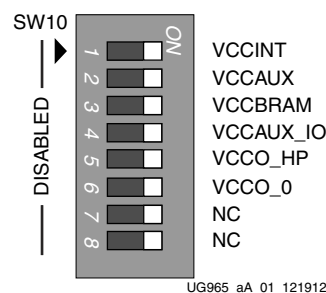

Figure A-1: Default Switch Settings

VITA 57.1 FMC Connector Pinouts

Figure B-1 provides a cross-reference of signal names to pin coordinates for the VITA 57.1 FMC HPC connector.

	K	J	H	G	F	E	D	C	B	A
1	VREF_B_M2C	GND	VREF_A_M2C	GND	PG_M2C	GND	PG_C2M	GND	RES1	GND
2	GND	CLK3_M2C_P	PRSNT_M2C_L	CLK1_M2C_P	GND	HA01_P_CC	GND	DP0_C2M_P	GND	DP1_M2C_P
3	GND	CLK3_M2C_N	GND	CLK1_M2C_N	GND	HA01_N_CC	GND	DP0_C2M_N	GND	DP1_M2C_N
4	CLK2_M2C_P	GND	CLK0_M2C_P	GND	HA00_P_CC	GND	GBTCLK0_M2C_P	GND	DP9_M2C_P	GND
5	CLK2_M2C_N	GND	CLK0_M2C_N	GND	HA00_N_CC	GND	GBTCLK0_M2C_N	GND	DP9_M2C_N	GND
6	GND	HA03_P	GND	LA00_P_CC	GND	HA05_P	GND	DP0_M2C_P	GND	DP2_M2C_P
7	HA02_P	HA03_N	LA02_P	LA00_N_CC	HA04_P	HA05_N	GND	DP0_M2C_N	GND	DP2_M2C_N
8	HA02_N	GND	LA02_N	GND	HA04_N	GND	LA01_P_CC	GND	DP8_M2C_P	GND
9	GND	HA07_P	GND	LA03_P	GND	HA09_P	LA01_N_CC	GND	DP8_M2C_N	GND
10	HA06_P	HA07_N	LA04_P	LA03_N	HA08_P	HA09_N	GND	LA06_P	GND	DP3_M2C_P
11	HA06_N	GND	LA04_N	GND	HA08_N	GND	LA05_P	LA06_N	GND	DP3_M2C_N
12	GND	HA11_P	GND	LA08_P	GND	HA13_P	LA05_N	GND	DP7_M2C_P	GND
13	HA10_P	HA11_N	LA07_P	LA08_N	HA12_P	HA13_N	GND	GND	DP7_M2C_N	GND
14	HA10_N	GND	LA07_N	GND	HA12_N	GND	LA09_P	LA10_P	GND	DP4_M2C_P
15	GND	HA14_P	GND	LA12_P	GND	HA16_P	LA09_N	LA10_N	GND	DP4_M2C_N
16	HA17_P_CC	HA14_N	LA11_P	LA12_N	HA15_P	HA16_N	GND	GND	DP6_M2C_P	GND
17	HA17_N_CC	GND	LA11_N	GND	HA15_N	GND	LA13_P	GND	DP6_M2C_N	GND
18	GND	HA18_P	GND	LA16_P	GND	HA20_P	LA13_N	LA14_P	GND	DP5_M2C_P
19	HA21_P	HA18_N	LA15_P	LA16_N	HA19_P	HA20_N	GND	LA14_N	GND	DP5_M2C_N
20	HA21_N	GND	LA15_N	GND	HA19_N	GND	LA17_P_CC	GND	GBTCLK1_M2C_P	GND
21	GND	HA22_P	GND	LA20_P	GND	HB03_P	LA17_N_CC	GND	GBTCLK1_M2C_N	GND
22	HA23_P	HA22_N	LA19_P	LA20_N	HB02_P	HB03_N	GND	LA18_P_CC	GND	DP1_C2M_P
23	HA23_N	GND	LA19_N	GND	HB02_N	GND	LA23_P	LA18_N_CC	GND	DP1_C2M_N
24	GND	HB01_P	GND	LA22_P	GND	HB05_P	LA23_N	GND	DP9_C2M_P	GND
25	HB00_P_CC	HB01_N	LA21_P	LA22_N	HB04_P	HB05_N	GND	GND	DP9_C2M_N	GND
26	HB00_N_CC	GND	LA21_N	GND	HB04_N	GND	LA26_P	LA27_P	GND	DP2_C2M_P
27	GND	HB07_P	GND	LA25_P	GND	HB09_P	LA26_N	LA27_N	GND	DP2_C2M_N
28	HB06_P_CC	HB07_N	LA24_P	LA25_N	HB08_P	HB09_N	GND	GND	DP8_C2M_P	GND
29	HB06_N_CC	GND	LA24_N	GND	HB08_N	GND	TCK	GND	DP8_C2M_N	GND
30	GND	HB11_P	GND	LA29_P	GND	HB13_P	TDI	SCL	GND	DP3_C2M_P
31	HB10_P	HB11_N	LA28_P	LA29_N	HB12_P	HB13_N	TDO	SDA	GND	DP3_C2M_N
32	HB10_N	GND	LA28_N	GND	HB12_N	GND	3P3VAUX	GND	DP7_C2M_P	GND
33	GND	HB15_P	GND	LA31_P	GND	HB19_P	TMS	GND	DP7_C2M_N	GND
34	HB14_P	HB15_N	LA30_P	LA31_N	HB16_P	HB19_N	TRST_L	GA0	GND	DP4_C2M_P
35	HB14_N	GND	LA30_N	GND	HB16_N	GND	GA1	12P0V	GND	DP4_C2M_N
36	GND	HB18_P	GND	LA33_P	GND	HB21_P	3P3V	GND	DP6_C2M_P	GND
37	HB17_P_CC	HB18_N	LA32_P	LA33_N	HB20_P	HB21_N	GND	12P0V	DP6_C2M_N	GND
38	HB17_N_CC	GND	LA32_N	GND	HB20_N	GND	3P3V	GND	GND	DP5_C2M_P
39	GND	VIO_B_M2C	GND	VADJ	GND	VADJ	GND	3P3V	GND	DP5_C2M_N
40	VIO_B_M2C	GND	VADJ	GND	VADJ	GND	3P3V	GND	RES0	GND

UG957_ab_01_070313

Figure B-1: FMC HPC Connector Pinout

Master Constraints File Listing

The VC7222 board master Xilinx design constraints (XDC) file template is provided for designs targeting the VC7222 Virtex®-7 FPGA GTH and GTZ Transceiver Characterization Board. Net names in the constraints listed below correlate with net names on the VC7222 board schematic. Users must identify the appropriate pins and replace the net names below with net names in the user RTL. See *Vivado Design Suite User Guide: Using Constraints* (UG903) [Ref 4] for more information.

VC7222 Board XDC Listing

```
#FMC1
set_property PACKAGE_PIN AP1 [get_ports FMC1_PRSNT_M2C_L]
set_property IOSTANDARD LVCMOS18 [get_ports FMC1_PRSNT_M2C_L]
set_property PACKAGE_PIN AK2 [get_ports FMC1_CLK0_M2C_P]
set_property IOSTANDARD LVCMOS18 [get_ports FMC1_CLK0_M2C_P]
set_property PACKAGE_PIN AL2 [get_ports FMC1_CLK0_M2C_N]
set_property IOSTANDARD LVCMOS18 [get_ports FMC1_CLK0_M2C_N]
set_property PACKAGE_PIN AJ15 [get_ports FMC1_CLK1_M2C_P]
set_property IOSTANDARD LVCMOS18 [get_ports FMC1_CLK1_M2C_P]
set_property PACKAGE_PIN AK15 [get_ports FMC1_CLK1_M2C_N]
set_property IOSTANDARD LVCMOS18 [get_ports FMC1_CLK1_M2C_N]
set_property PACKAGE_PIN AK3 [get_ports FMC1_CLK2_BIDIR_P]
set_property IOSTANDARD LVDS [get_ports FMC1_CLK2_BIDIR_P]
set_property PACKAGE_PIN AL3 [get_ports FMC1_CLK2_BIDIR_N]
set_property IOSTANDARD LVDS [get_ports FMC1_CLK2_BIDIR_N]
set_property PACKAGE_PIN AL15 [get_ports FMC1_CLK3_BIDIR_P]
set_property IOSTANDARD LVCMOS18 [get_ports FMC1_CLK3_BIDIR_P]
set_property PACKAGE_PIN AL14 [get_ports FMC1_CLK3_BIDIR_N]
set_property IOSTANDARD LVCMOS18 [get_ports FMC1_CLK3_BIDIR_N]
#FMC1 LA
set_property PACKAGE_PIN AJ5 [get_ports FMC1_LA00_CC_P]
set_property IOSTANDARD LVCMOS18 [get_ports FMC1_LA00_CC_P]
set_property PACKAGE_PIN AK5 [get_ports FMC1_LA00_CC_N]
set_property IOSTANDARD LVCMOS18 [get_ports FMC1_LA00_CC_N]
set_property PACKAGE_PIN AJ4 [get_ports FMC1_LA01_CC_P]
set_property IOSTANDARD LVCMOS18 [get_ports FMC1_LA01_CC_P]
set_property PACKAGE_PIN AJ3 [get_ports FMC1_LA01_CC_N]
set_property IOSTANDARD LVCMOS18 [get_ports FMC1_LA01_CC_N]
set_property PACKAGE_PIN AG6 [get_ports FMC1_LA02_P]
set_property IOSTANDARD LVCMOS18 [get_ports FMC1_LA02_P]
set_property PACKAGE_PIN AG5 [get_ports FMC1_LA02_N]
set_property IOSTANDARD LVCMOS18 [get_ports FMC1_LA02_N]
set_property PACKAGE_PIN AH6 [get_ports FMC1_LA03_P]
set_property IOSTANDARD LVCMOS18 [get_ports FMC1_LA03_P]
set_property PACKAGE_PIN AJ6 [get_ports FMC1_LA03_N]
```

```
set_property IOSTANDARD LVCMOS18 [get_ports FMC1_LA03_N]
set_property PACKAGE_PIN AG7 [get_ports FMC1_LA04_P]
set_property IOSTANDARD LVCMOS18 [get_ports FMC1_LA04_P]
set_property PACKAGE_PIN AH7 [get_ports FMC1_LA04_N]
set_property IOSTANDARD LVCMOS18 [get_ports FMC1_LA04_N]
set_property PACKAGE_PIN AE7 [get_ports FMC1_LA05_P]
set_property IOSTANDARD LVCMOS18 [get_ports FMC1_LA05_P]
set_property PACKAGE_PIN AF7 [get_ports FMC1_LA05_N]
set_property IOSTANDARD LVCMOS18 [get_ports FMC1_LA05_N]
set_property PACKAGE_PIN AK7 [get_ports FMC1_LA06_P]
set_property IOSTANDARD LVCMOS18 [get_ports FMC1_LA06_P]
set_property PACKAGE_PIN AK6 [get_ports FMC1_LA06_N]
set_property IOSTANDARD LVCMOS18 [get_ports FMC1_LA06_N]
set_property PACKAGE_PIN AF4 [get_ports FMC1_LA07_P]
set_property IOSTANDARD LVCMOS18 [get_ports FMC1_LA07_P]
set_property PACKAGE_PIN AG4 [get_ports FMC1_LA07_N]
set_property IOSTANDARD LVCMOS18 [get_ports FMC1_LA07_N]
set_property PACKAGE_PIN AH4 [get_ports FMC1_LA08_P]
set_property IOSTANDARD LVCMOS18 [get_ports FMC1_LA08_P]
set_property PACKAGE_PIN AH3 [get_ports FMC1_LA08_N]
set_property IOSTANDARD LVCMOS18 [get_ports FMC1_LA08_N]
set_property PACKAGE_PIN AG2 [get_ports FMC1_LA09_P]
set_property IOSTANDARD LVCMOS18 [get_ports FMC1_LA09_P]
set_property PACKAGE_PIN AH2 [get_ports FMC1_LA09_N]
set_property IOSTANDARD LVCMOS18 [get_ports FMC1_LA09_N]
set_property PACKAGE_PIN AM2 [get_ports FMC1_LA10_P]
set_property IOSTANDARD LVCMOS18 [get_ports FMC1_LA10_P]
set_property PACKAGE_PIN AN2 [get_ports FMC1_LA10_N]
set_property IOSTANDARD LVCMOS18 [get_ports FMC1_LA10_N]
set_property PACKAGE_PIN AM1 [get_ports FMC1_LA11_P]
set_property IOSTANDARD LVCMOS18 [get_ports FMC1_LA11_P]
set_property PACKAGE_PIN AN1 [get_ports FMC1_LA11_N]
set_property IOSTANDARD LVCMOS18 [get_ports FMC1_LA11_N]
set_property PACKAGE_PIN AJ1 [get_ports FMC1_LA12_P]
set_property IOSTANDARD LVCMOS18 [get_ports FMC1_LA12_P]
set_property PACKAGE_PIN AK1 [get_ports FMC1_LA12_N]
set_property IOSTANDARD LVCMOS18 [get_ports FMC1_LA12_N]
set_property PACKAGE_PIN AN3 [get_ports FMC1_LA13_P]
set_property IOSTANDARD LVCMOS18 [get_ports FMC1_LA13_P]
set_property PACKAGE_PIN AP3 [get_ports FMC1_LA13_N]
set_property IOSTANDARD LVCMOS18 [get_ports FMC1_LA13_N]
set_property PACKAGE_PIN AM6 [get_ports FMC1_LA14_P]
set_property IOSTANDARD LVCMOS18 [get_ports FMC1_LA14_P]
set_property PACKAGE_PIN AM5 [get_ports FMC1_LA14_N]
set_property IOSTANDARD LVCMOS18 [get_ports FMC1_LA14_N]
set_property PACKAGE_PIN AL7 [get_ports FMC1_LA15_P]
set_property IOSTANDARD LVCMOS18 [get_ports FMC1_LA15_P]
set_property PACKAGE_PIN AM7 [get_ports FMC1_LA15_N]
set_property IOSTANDARD LVCMOS18 [get_ports FMC1_LA15_N]
set_property PACKAGE_PIN AM4 [get_ports FMC1_LA16_P]
set_property IOSTANDARD LVCMOS18 [get_ports FMC1_LA16_P]
set_property PACKAGE_PIN AN4 [get_ports FMC1_LA16_N]
set_property IOSTANDARD LVCMOS18 [get_ports FMC1_LA16_N]
set_property PACKAGE_PIN AM16 [get_ports FMC1_LA17_CC_P]
set_property IOSTANDARD LVCMOS18 [get_ports FMC1_LA17_CC_P]
set_property PACKAGE_PIN AM15 [get_ports FMC1_LA17_CC_N]
set_property IOSTANDARD LVCMOS18 [get_ports FMC1_LA17_CC_N]
set_property PACKAGE_PIN AM14 [get_ports FMC1_LA18_CC_P]
set_property IOSTANDARD LVCMOS18 [get_ports FMC1_LA18_CC_P]
```



```
set_property PACKAGE_PIN AN14 [get_ports FMC1_LA18_CC_N]
set_property IOSTANDARD LVCMOS18 [get_ports FMC1_LA18_CC_N]
set_property PACKAGE_PIN AB17 [get_ports FMC1_LA19_P]
set_property IOSTANDARD LVCMOS18 [get_ports FMC1_LA19_P]
set_property PACKAGE_PIN AC17 [get_ports FMC1_LA19_N]
set_property IOSTANDARD LVCMOS18 [get_ports FMC1_LA19_N]
set_property PACKAGE_PIN AG17 [get_ports FMC1_LA20_P]
set_property IOSTANDARD LVCMOS18 [get_ports FMC1_LA20_P]
set_property PACKAGE_PIN AH17 [get_ports FMC1_LA20_N]
set_property IOSTANDARD LVCMOS18 [get_ports FMC1_LA20_N]
set_property PACKAGE_PIN AD16 [get_ports FMC1_LA21_P]
set_property IOSTANDARD LVCMOS18 [get_ports FMC1_LA21_P]
set_property PACKAGE_PIN AE16 [get_ports FMC1_LA21_N]
set_property IOSTANDARD LVCMOS18 [get_ports FMC1_LA21_N]
set_property PACKAGE_PIN AB16 [get_ports FMC1_LA22_P]
set_property IOSTANDARD LVCMOS18 [get_ports FMC1_LA22_P]
set_property PACKAGE_PIN AC16 [get_ports FMC1_LA22_N]
set_property IOSTANDARD LVCMOS18 [get_ports FMC1_LA22_N]
set_property PACKAGE_PIN AE17 [get_ports FMC1_LA23_P]
set_property IOSTANDARD LVCMOS18 [get_ports FMC1_LA23_P]
set_property PACKAGE_PIN AF17 [get_ports FMC1_LA23_N]
set_property IOSTANDARD LVCMOS18 [get_ports FMC1_LA23_N]
set_property PACKAGE_PIN AG16 [get_ports FMC1_LA24_P]
set_property IOSTANDARD LVCMOS18 [get_ports FMC1_LA24_P]
set_property PACKAGE_PIN AH16 [get_ports FMC1_LA24_N]
set_property IOSTANDARD LVCMOS18 [get_ports FMC1_LA24_N]
set_property PACKAGE_PIN AK17 [get_ports FMC1_LA25_P]
set_property IOSTANDARD LVCMOS18 [get_ports FMC1_LA25_P]
set_property PACKAGE_PIN AL17 [get_ports FMC1_LA25_N]
set_property IOSTANDARD LVCMOS18 [get_ports FMC1_LA25_N]
set_property PACKAGE_PIN AN16 [get_ports FMC1_LA26_P]
set_property IOSTANDARD LVCMOS18 [get_ports FMC1_LA26_P]
set_property PACKAGE_PIN AP16 [get_ports FMC1_LA26_N]
set_property IOSTANDARD LVCMOS18 [get_ports FMC1_LA26_N]
set_property PACKAGE_PIN AM17 [get_ports FMC1_LA27_P]
set_property IOSTANDARD LVCMOS18 [get_ports FMC1_LA27_P]
set_property PACKAGE_PIN AN17 [get_ports FMC1_LA27_N]
set_property IOSTANDARD LVCMOS18 [get_ports FMC1_LA27_N]
set_property PACKAGE_PIN AP15 [get_ports FMC1_LA28_P]
set_property IOSTANDARD LVCMOS18 [get_ports FMC1_LA28_P]
set_property PACKAGE_PIN AP14 [get_ports FMC1_LA28_N]
set_property IOSTANDARD LVCMOS18 [get_ports FMC1_LA28_N]
set_property PACKAGE_PIN AJ16 [get_ports FMC1_LA29_P]
set_property IOSTANDARD LVCMOS18 [get_ports FMC1_LA29_P]
set_property PACKAGE_PIN AK16 [get_ports FMC1_LA29_N]
set_property IOSTANDARD LVCMOS18 [get_ports FMC1_LA29_N]
set_property PACKAGE_PIN AD15 [get_ports FMC1_LA30_P]
set_property IOSTANDARD LVCMOS18 [get_ports FMC1_LA30_P]
set_property PACKAGE_PIN AE15 [get_ports FMC1_LA30_N]
set_property IOSTANDARD LVCMOS18 [get_ports FMC1_LA30_N]
set_property PACKAGE_PIN AK13 [get_ports FMC1_LA31_P]
set_property IOSTANDARD LVCMOS18 [get_ports FMC1_LA31_P]
set_property PACKAGE_PIN AL13 [get_ports FMC1_LA31_N]
set_property IOSTANDARD LVCMOS18 [get_ports FMC1_LA31_N]
set_property PACKAGE_PIN AF15 [get_ports FMC1_LA32_P]
set_property IOSTANDARD LVCMOS18 [get_ports FMC1_LA32_P]
set_property PACKAGE_PIN AG15 [get_ports FMC1_LA32_N]
set_property IOSTANDARD LVCMOS18 [get_ports FMC1_LA32_N]
set_property PACKAGE_PIN AH14 [get_ports FMC1_LA33_P]
```

```

set_property IOSTANDARD LVCMOS18 [get_ports FMC1_LA33_P]
set_property PACKAGE_PIN AJ14 [get_ports FMC1_LA33_N]
set_property IOSTANDARD LVCMOS18 [get_ports FMC1_LA33_N]
#FMC2
set_property PACKAGE_PIN AN34 [get_ports FMC2_PRSN2_M2C_L]
set_property IOSTANDARD LVCMOS18 [get_ports FMC2_PRSN2_M2C_L]
set_property PACKAGE_PIN AH31 [get_ports FMC2_CLK0_M2C_P]
set_property IOSTANDARD LVCMOS18 [get_ports FMC2_CLK0_M2C_P]
set_property PACKAGE_PIN AJ31 [get_ports IO_L11N_T1_SRCC_14]
set_property IOSTANDARD LVCMOS18 [get_ports IO_L11N_T1_SRCC_14]
set_property PACKAGE_PIN AK33 [get_ports FMC2_CLK1_M2C_P]
set_property IOSTANDARD LVCMOS18 [get_ports FMC2_CLK1_M2C_P]
set_property PACKAGE_PIN AL33 [get_ports FMC2_CLK1_M2C_N]
set_property IOSTANDARD LVCMOS18 [get_ports FMC2_CLK1_M2C_N]
#FMC2 LA
set_property PACKAGE_PIN AK32 [get_ports FMC2_LA00_CC_P]
set_property IOSTANDARD LVDS [get_ports FMC2_LA00_CC_P]
set_property PACKAGE_PIN AL32 [get_ports FMC2_LA00_CC_N]
set_property IOSTANDARD LVDS [get_ports FMC2_LA00_CC_N]
set_property PACKAGE_PIN AK30 [get_ports FMC2_LA01_CC_P]
set_property IOSTANDARD LVCMOS18 [get_ports FMC2_LA01_CC_P]
set_property PACKAGE_PIN AK31 [get_ports FMC2_LA01_CC_N]
set_property IOSTANDARD LVCMOS18 [get_ports FMC2_LA01_CC_N]
set_property PACKAGE_PIN AE28 [get_ports FMC2_LA02_P]
set_property IOSTANDARD LVCMOS18 [get_ports FMC2_LA02_P]
set_property PACKAGE_PIN AF28 [get_ports FMC2_LA02_N]
set_property IOSTANDARD LVCMOS18 [get_ports FMC2_LA02_N]
set_property PACKAGE_PIN AJ29 [get_ports FMC2_LA03_P]
set_property IOSTANDARD LVCMOS18 [get_ports FMC2_LA03_P]
set_property PACKAGE_PIN AJ30 [get_ports FMC2_LA03_N]
set_property IOSTANDARD LVCMOS18 [get_ports FMC2_LA03_N]
set_property PACKAGE_PIN AF29 [get_ports FMC2_LA04_P]
set_property IOSTANDARD LVCMOS18 [get_ports FMC2_LA04_P]
set_property PACKAGE_PIN AG29 [get_ports FMC2_LA04_N]
set_property IOSTANDARD LVCMOS18 [get_ports FMC2_LA04_N]
set_property PACKAGE_PIN AH28 [get_ports FMC2_LA05_P]
set_property IOSTANDARD LVCMOS18 [get_ports FMC2_LA05_P]
set_property PACKAGE_PIN AH29 [get_ports FMC2_LA05_N]
set_property IOSTANDARD LVCMOS18 [get_ports FMC2_LA05_N]
set_property PACKAGE_PIN AJ28 [get_ports FMC2_LA06_P]
set_property IOSTANDARD LVCMOS18 [get_ports FMC2_LA06_P]
set_property PACKAGE_PIN AK28 [get_ports FMC2_LA06_N]
set_property IOSTANDARD LVCMOS18 [get_ports FMC2_LA06_N]
set_property PACKAGE_PIN AL28 [get_ports FMC2_LA07_P]
set_property IOSTANDARD LVCMOS18 [get_ports FMC2_LA07_P]
set_property PACKAGE_PIN AL29 [get_ports FMC2_LA07_N]
set_property IOSTANDARD LVCMOS18 [get_ports FMC2_LA07_N]
set_property PACKAGE_PIN AF30 [get_ports FMC2_LA08_P]
set_property IOSTANDARD LVCMOS18 [get_ports FMC2_LA08_P]
set_property PACKAGE_PIN AG30 [get_ports FMC2_LA08_N]
set_property IOSTANDARD LVCMOS18 [get_ports FMC2_LA08_N]
set_property PACKAGE_PIN AG31 [get_ports FMC2_LA09_P]
set_property IOSTANDARD LVCMOS18 [get_ports FMC2_LA09_P]
set_property PACKAGE_PIN AG32 [get_ports FMC2_LA09_N]
set_property IOSTANDARD LVCMOS18 [get_ports FMC2_LA09_N]
set_property PACKAGE_PIN AH32 [get_ports FMC2_LA10_N]
set_property IOSTANDARD LVCMOS18 [get_ports FMC2_LA10_N]
set_property PACKAGE_PIN AH33 [get_ports FMC2_LA10_N]
set_property IOSTANDARD LVCMOS18 [get_ports FMC2_LA10_N]

```

```
set_property PACKAGE_PIN AG34 [get_ports FMC2_LA11_P]
set_property IOSTANDARD LVCMOS18 [get_ports FMC2_LA11_P]
set_property PACKAGE_PIN AH34 [get_ports FMC2_LA11_N]
set_property IOSTANDARD LVCMOS18 [get_ports FMC2_LA11_N]
set_property PACKAGE_PIN AM32 [get_ports FMC2_LA12_P]
set_property IOSTANDARD LVCMOS18 [get_ports FMC2_LA12_P]
set_property PACKAGE_PIN AN32 [get_ports FMC2_LA12_N]
set_property IOSTANDARD LVCMOS18 [get_ports FMC2_LA12_N]
set_property PACKAGE_PIN AL34 [get_ports FMC2_LA13_P]
set_property IOSTANDARD LVCMOS18 [get_ports FMC2_LA13_P]
set_property PACKAGE_PIN AM34 [get_ports FMC2_LA13_N]
set_property IOSTANDARD LVCMOS18 [get_ports FMC2_LA13_N]
set_property PACKAGE_PIN AJ33 [get_ports FMC2_LA14_P]
set_property IOSTANDARD LVCMOS18 [get_ports FMC2_LA14_P]
set_property PACKAGE_PIN AJ34 [get_ports FMC2_LA14_N]
set_property IOSTANDARD LVCMOS18 [get_ports FMC2_LA14_N]
set_property PACKAGE_PIN AN33 [get_ports FMC2_LA15_P]
set_property IOSTANDARD LVCMOS18 [get_ports FMC2_LA15_P]
set_property PACKAGE_PIN AP33 [get_ports FMC2_LA15_N]
set_property IOSTANDARD LVCMOS18 [get_ports FMC2_LA15_N]
set_property PACKAGE_PIN AM29 [get_ports FMC2_LA16_P]
set_property IOSTANDARD LVCMOS18 [get_ports FMC2_LA16_P]
set_property PACKAGE_PIN AN29 [get_ports FMC2_LA16_N]
set_property IOSTANDARD LVCMOS18 [get_ports FMC2_LA16_N]
set_property PACKAGE_PIN AJ20 [get_ports FMC2_LA17_CC_P]
set_property IOSTANDARD LVCMOS18 [get_ports FMC2_LA17_CC_P]
set_property PACKAGE_PIN AK20 [get_ports FMC2_LA17_CC_N]
set_property IOSTANDARD LVCMOS18 [get_ports FMC2_LA17_CC_N]
set_property PACKAGE_PIN AA20 [get_ports FMC2_LA18_CC_P]
set_property IOSTANDARD LVCMOS18 [get_ports FMC2_LA18_CC_P]
set_property PACKAGE_PIN AB20 [get_ports FMC2_LA18_CC_N]
set_property IOSTANDARD LVCMOS18 [get_ports FMC2_LA18_CC_N]
set_property PACKAGE_PIN AF19 [get_ports FMC2_LA19_P]
set_property IOSTANDARD LVCMOS18 [get_ports FMC2_LA19_P]
set_property PACKAGE_PIN AG19 [get_ports FMC2_LA19_N]
set_property IOSTANDARD LVCMOS18 [get_ports FMC2_LA19_N]
set_property PACKAGE_PIN AK18 [get_ports FMC2_LA20_P]
set_property IOSTANDARD LVCMOS18 [get_ports FMC2_LA20_P]
set_property PACKAGE_PIN AL18 [get_ports FMC2_LA20_N]
set_property IOSTANDARD LVCMOS18 [get_ports FMC2_LA20_N]
set_property PACKAGE_PIN AP20 [get_ports FMC2_LA21_P]
set_property IOSTANDARD LVCMOS18 [get_ports FMC2_LA21_P]
set_property PACKAGE_PIN AP21 [get_ports FMC2_LA21_N]
set_property IOSTANDARD LVCMOS18 [get_ports FMC2_LA21_N]
set_property PACKAGE_PIN AN19 [get_ports FMC2_LA22_P]
set_property IOSTANDARD LVCMOS18 [get_ports FMC2_LA22_P]
set_property PACKAGE_PIN AP19 [get_ports FMC2_LA22_N]
set_property IOSTANDARD LVCMOS18 [get_ports FMC2_LA22_N]
set_property PACKAGE_PIN AN18 [get_ports FMC2_LA23_P]
set_property IOSTANDARD LVCMOS18 [get_ports FMC2_LA23_P]
set_property PACKAGE_PIN AP18 [get_ports FMC2_LA23_N]
set_property IOSTANDARD LVCMOS18 [get_ports FMC2_LA23_N]
set_property PACKAGE_PIN AJ18 [get_ports FMC2_LA24_P]
set_property IOSTANDARD LVCMOS18 [get_ports FMC2_LA24_P]
set_property PACKAGE_PIN AJ19 [get_ports FMC2_LA24_N]
set_property IOSTANDARD LVCMOS18 [get_ports FMC2_LA24_N]
set_property PACKAGE_PIN AD20 [get_ports FMC2_LA25_P]
set_property IOSTANDARD LVCMOS18 [get_ports FMC2_LA25_P]
set_property PACKAGE_PIN AE20 [get_ports FMC2_LA25_N]
```

```

set_property IOSTANDARD LVCMOS18 [get_ports FMC2_LA25_N]
set_property PACKAGE_PIN AH21 [get_ports FMC2_LA26_P]
set_property IOSTANDARD LVCMOS18 [get_ports FMC2_LA26_P]
set_property PACKAGE_PIN AJ21 [get_ports FMC2_LA26_N]
set_property IOSTANDARD LVCMOS18 [get_ports FMC2_LA26_N]
set_property PACKAGE_PIN AF20 [get_ports FMC2_LA27_P]
set_property IOSTANDARD LVCMOS18 [get_ports FMC2_LA27_P]
set_property PACKAGE_PIN AG20 [get_ports FMC2_LA27_N]
set_property IOSTANDARD LVCMOS18 [get_ports FMC2_LA27_N]
set_property PACKAGE_PIN AK21 [get_ports FMC2_LA28_P]
set_property IOSTANDARD LVCMOS18 [get_ports FMC2_LA28_P]
set_property PACKAGE_PIN AK22 [get_ports FMC2_LA28_N]
set_property IOSTANDARD LVCMOS18 [get_ports FMC2_LA28_N]
set_property PACKAGE_PIN AB21 [get_ports FMC2_LA29_P]
set_property IOSTANDARD LVCMOS18 [get_ports FMC2_LA29_P]
set_property PACKAGE_PIN AC21 [get_ports FMC2_LA29_N]
set_property IOSTANDARD LVCMOS18 [get_ports FMC2_LA29_N]
set_property PACKAGE_PIN AD21 [get_ports FMC2_LA30_P]
set_property IOSTANDARD LVCMOS18 [get_ports FMC2_LA30_P]
set_property PACKAGE_PIN AE21 [get_ports FMC2_LA30_N]
set_property IOSTANDARD LVCMOS18 [get_ports FMC2_LA30_N]
set_property PACKAGE_PIN AB22 [get_ports FMC2_LA31_P]
set_property IOSTANDARD LVCMOS18 [get_ports FMC2_LA31_P]
set_property PACKAGE_PIN AC22 [get_ports FMC2_LA31_N]
set_property IOSTANDARD LVCMOS18 [get_ports FMC2_LA31_N]
set_property PACKAGE_PIN AG22 [get_ports FMC2_LA32_P]
set_property IOSTANDARD LVCMOS18 [get_ports FMC2_LA32_P]
set_property PACKAGE_PIN AH22 [get_ports FMC2_LA32_N]
set_property IOSTANDARD LVCMOS18 [get_ports FMC2_LA32_N]
set_property PACKAGE_PIN AE22 [get_ports FMC2_LA33_P]
set_property IOSTANDARD LVCMOS18 [get_ports FMC2_LA33_P]
set_property PACKAGE_PIN AF22 [get_ports FMC2_LA33_N]
set_property IOSTANDARD LVCMOS18 [get_ports FMC2_LA33_N]
#FMC2 HA
set_property PACKAGE_PIN AM19 [get_ports FMC2_HA00_CC_P]
set_property IOSTANDARD LVCMOS18 [get_ports FMC2_HA00_CC_P]
set_property PACKAGE_PIN AM20 [get_ports FMC2_HA00_CC_N]
set_property IOSTANDARD LVCMOS18 [get_ports FMC2_HA00_CC_N]
set_property PACKAGE_PIN AM21 [get_ports FMC2_HA01_CC_P]
set_property IOSTANDARD LVCMOS18 [get_ports FMC2_HA01_CC_P]
set_property PACKAGE_PIN AN21 [get_ports FMC2_HA01_CC_N]
set_property IOSTANDARD LVCMOS18 [get_ports FMC2_HA01_CC_N]
set_property PACKAGE_PIN AC18 [get_ports FMC2_HA02_P]
set_property IOSTANDARD LVCMOS18 [get_ports FMC2_HA02_P]
set_property PACKAGE_PIN AD18 [get_ports FMC2_HA02_N]
set_property IOSTANDARD LVCMOS18 [get_ports FMC2_HA02_N]
set_property PACKAGE_PIN AH18 [get_ports FMC2_HA03_P]
set_property IOSTANDARD LVCMOS18 [get_ports FMC2_HA03_P]
set_property PACKAGE_PIN AH19 [get_ports FMC2_HA03_N]
set_property IOSTANDARD LVCMOS18 [get_ports FMC2_HA03_N]
set_property PACKAGE_PIN AC19 [get_ports FMC2_HA04_P]
set_property IOSTANDARD LVCMOS18 [get_ports FMC2_HA04_P]
set_property PACKAGE_PIN AD19 [get_ports FMC2_HA04_N]
set_property IOSTANDARD LVCMOS18 [get_ports FMC2_HA04_N]
set_property PACKAGE_PIN AE18 [get_ports FMC2_HA05_P]
set_property IOSTANDARD LVCMOS18 [get_ports FMC2_HA05_P]
set_property PACKAGE_PIN AF18 [get_ports FMC2_HA05_N]
set_property IOSTANDARD LVCMOS18 [get_ports FMC2_HA05_N]
set_property PACKAGE_PIN AK26 [get_ports FMC2_HA06_P]

```

```

set_property IOSTANDARD LVCMOS18 [get_ports FMC2_HA06_P]
set_property PACKAGE_PIN AK27 [get_ports FMC2_HA06_N]
set_property IOSTANDARD LVCMOS18 [get_ports FMC2_HA06_N]
set_property PACKAGE_PIN AE23 [get_ports FMC2_HA07_P]
set_property IOSTANDARD LVCMOS18 [get_ports FMC2_HA07_P]
set_property PACKAGE_PIN AF23 [get_ports FMC2_HA07_N]
set_property IOSTANDARD LVCMOS18 [get_ports FMC2_HA07_N]
set_property PACKAGE_PIN AP24 [get_ports FMC2_HA08_P]
set_property IOSTANDARD LVCMOS18 [get_ports FMC2_HA08_P]
set_property PACKAGE_PIN AP25 [get_ports FMC2_HA08_N]
set_property IOSTANDARD LVCMOS18 [get_ports FMC2_HA08_N]
set_property PACKAGE_PIN AK23 [get_ports FMC2_HA09_P]
set_property IOSTANDARD LVCMOS18 [get_ports FMC2_HA09_P]
set_property PACKAGE_PIN AL23 [get_ports FMC2_HA09_N]
set_property IOSTANDARD LVCMOS18 [get_ports FMC2_HA09_N]
set_property PACKAGE_PIN AN23 [get_ports FMC2_HA10_P]
set_property IOSTANDARD LVCMOS18 [get_ports FMC2_HA10_P]
set_property PACKAGE_PIN AP23 [get_ports FMC2_HA10_N]
set_property IOSTANDARD LVCMOS18 [get_ports FMC2_HA10_N]
set_property PACKAGE_PIN AL19 [get_ports FMC2_HA17_CC_P]
set_property IOSTANDARD LVCMOS18 [get_ports FMC2_HA17_CC_P]
set_property PACKAGE_PIN AL20 [get_ports FMC2_HA17_CC_N]
set_property IOSTANDARD LVCMOS18 [get_ports FMC2_HA17_CC_N]
#FMC2 HB
set_property PACKAGE_PIN AH24 [get_ports FMC2_HB00_CC_P]
set_property IOSTANDARD LVCMOS18 [get_ports FMC2_HB00_CC_P]
set_property PACKAGE_PIN AJ24 [get_ports FMC2_HB00_CC_N]
set_property IOSTANDARD LVCMOS18 [get_ports FMC2_HB00_CC_N]
set_property PACKAGE_PIN AC23 [get_ports FMC2_HB01_P]
set_property IOSTANDARD LVCMOS18 [get_ports FMC2_HB01_P]
set_property PACKAGE_PIN AD23 [get_ports FMC2_HB01_N]
set_property IOSTANDARD LVCMOS18 [get_ports FMC2_HB01_N]
set_property PACKAGE_PIN AD24 [get_ports FMC2_HB02_P]
set_property IOSTANDARD LVCMOS18 [get_ports FMC2_HB02_P]
set_property PACKAGE_PIN AD25 [get_ports FMC2_HB02_N]
set_property IOSTANDARD LVCMOS18 [get_ports FMC2_HB02_N]
set_property PACKAGE_PIN AB24 [get_ports FMC2_HB03_P]
set_property IOSTANDARD LVCMOS18 [get_ports FMC2_HB03_P]
set_property PACKAGE_PIN AC24 [get_ports FMC2_HB03_N]
set_property IOSTANDARD LVCMOS18 [get_ports FMC2_HB03_N]
set_property PACKAGE_PIN AM27 [get_ports FMC2_HB04_P]
set_property IOSTANDARD LVCMOS18 [get_ports FMC2_HB04_P]
set_property PACKAGE_PIN AN27 [get_ports FMC2_HB04_N]
set_property IOSTANDARD LVCMOS18 [get_ports FMC2_HB04_N]
set_property PACKAGE_PIN AL30 [get_ports FMC2_HB05_P]
set_property IOSTANDARD LVCMOS18 [get_ports FMC2_HB05_P]
set_property PACKAGE_PIN AM30 [get_ports FMC2_HB05_N]
set_property IOSTANDARD LVCMOS18 [get_ports FMC2_HB05_N]
set_property PACKAGE_PIN AJ25 [get_ports FMC2_HB06_CC_P]
set_property IOSTANDARD LVCMOS18 [get_ports FMC2_HB06_CC_P]
set_property PACKAGE_PIN AK25 [get_ports FMC2_HB06_CC_N]
set_property IOSTANDARD LVCMOS18 [get_ports FMC2_HB06_CC_N]
set_property PACKAGE_PIN AP29 [get_ports FMC2_HB07_P]
set_property IOSTANDARD LVCMOS18 [get_ports FMC2_HB07_P]
set_property PACKAGE_PIN AP30 [get_ports FMC2_HB07_N]
set_property IOSTANDARD LVCMOS18 [get_ports FMC2_HB07_N]
set_property PACKAGE_PIN AM31 [get_ports FMC2_HB08_P]
set_property IOSTANDARD LVCMOS18 [get_ports FMC2_HB08_P]
set_property PACKAGE_PIN AN31 [get_ports FMC2_HB08_N]

```

```

set_property IOSTANDARD LVCMOS18 [get_ports FMC2_HB08_N]
set_property PACKAGE_PIN AN28 [get_ports FMC2_HB09_P]
set_property IOSTANDARD LVCMOS18 [get_ports FMC2_HB09_P]
set_property PACKAGE_PIN AP28 [get_ports FMC2_HB09_N]
set_property IOSTANDARD LVCMOS18 [get_ports FMC2_HB09_N]
set_property PACKAGE_PIN AG25 [get_ports FMC2_HB17_CC_P]
set_property IOSTANDARD LVCMOS18 [get_ports FMC2_HB17_CC_P]
set_property PACKAGE_PIN AG26 [get_ports FMC2_HB17_CC_N]
set_property IOSTANDARD LVCMOS18 [get_ports FMC2_HB17_CC_N]
#SuperClock2_MODULE
set_property PACKAGE_PIN AE8 [get_ports CM_RST]
set_property IOSTANDARD LVCMOS18 [get_ports CM_RST]
set_property PACKAGE_PIN AF8 [get_ports CM_CTRL_0]
set_property IOSTANDARD LVCMOS18 [get_ports CM_CTRL_0]
set_property PACKAGE_PIN AH9 [get_ports CM_CTRL_1]
set_property IOSTANDARD LVCMOS18 [get_ports CM_CTRL_1]
set_property PACKAGE_PIN AH8 [get_ports CM_CTRL_2]
set_property IOSTANDARD LVCMOS18 [get_ports CM_CTRL_2]
set_property PACKAGE_PIN AJ9 [get_ports CM_CTRL_3]
set_property IOSTANDARD LVCMOS18 [get_ports CM_CTRL_3]
set_property PACKAGE_PIN AJ8 [get_ports CM_CTRL_4]
set_property IOSTANDARD LVCMOS18 [get_ports CM_CTRL_4]
set_property PACKAGE_PIN AM10 [get_ports CM_CTRL_5]
set_property IOSTANDARD LVCMOS18 [get_ports CM_CTRL_5]
set_property PACKAGE_PIN AM9 [get_ports CM_CTRL_6]
set_property IOSTANDARD LVCMOS18 [get_ports CM_CTRL_6]
set_property PACKAGE_PIN AF12 [get_ports CM_CTRL_7]
set_property IOSTANDARD LVCMOS18 [get_ports CM_CTRL_7]
set_property PACKAGE_PIN AF9 [get_ports CM_CTRL_8]
set_property IOSTANDARD LVCMOS18 [get_ports CM_CTRL_8]
set_property PACKAGE_PIN AG9 [get_ports CM_CTRL_9]
set_property IOSTANDARD LVCMOS18 [get_ports CM_CTRL_9]
set_property PACKAGE_PIN AG12 [get_ports CM_CTRL_10]
set_property IOSTANDARD LVCMOS18 [get_ports CM_CTRL_10]
set_property PACKAGE_PIN AH12 [get_ports CM_CTRL_11]
set_property IOSTANDARD LVCMOS18 [get_ports CM_CTRL_11]
set_property PACKAGE_PIN AP10 [get_ports CM_CTRL_12]
set_property IOSTANDARD LVCMOS18 [get_ports CM_CTRL_12]
set_property PACKAGE_PIN AP9 [get_ports CM_CTRL_13]
set_property IOSTANDARD LVCMOS18 [get_ports CM_CTRL_13]
set_property PACKAGE_PIN AK12 [get_ports CM_CTRL_14]
set_property IOSTANDARD LVCMOS18 [get_ports CM_CTRL_14]
set_property PACKAGE_PIN AL12 [get_ports CM_CTRL_15]
set_property IOSTANDARD LVCMOS18 [get_ports CM_CTRL_15]
set_property PACKAGE_PIN AN12 [get_ports CM_CTRL_16]
set_property IOSTANDARD LVCMOS18 [get_ports CM_CTRL_16]
set_property PACKAGE_PIN AN11 [get_ports CM_CTRL_17]
set_property IOSTANDARD LVCMOS18 [get_ports CM_CTRL_17]
set_property PACKAGE_PIN AN9 [get_ports CM_CTRL_18]
set_property IOSTANDARD LVCMOS18 [get_ports CM_CTRL_18]
set_property PACKAGE_PIN AN8 [get_ports CM_CTRL_19]
set_property IOSTANDARD LVCMOS18 [get_ports CM_CTRL_19]
set_property PACKAGE_PIN AN13 [get_ports CM_CTRL_20]
set_property IOSTANDARD LVCMOS18 [get_ports CM_CTRL_20]
set_property PACKAGE_PIN AP13 [get_ports CM_CTRL_21]
set_property IOSTANDARD LVCMOS18 [get_ports CM_CTRL_21]
set_property PACKAGE_PIN AM12 [get_ports CM_CTRL_22]
set_property IOSTANDARD LVCMOS18 [get_ports CM_CTRL_22]
set_property PACKAGE_PIN AM11 [get_ports CM_CTRL_23]

```

```

set_property IOSTANDARD LVCMOS18 [get_ports CM_CTRL_23]
set_property PACKAGE_PIN AK8 [get_ports CM_LVDS1_P]
set_property IOSTANDARD LVDS [get_ports CM_LVDS1_P]
set_property PACKAGE_PIN AL8 [get_ports CM_LVDS1_N]
set_property IOSTANDARD LVDS [get_ports CM_LVDS1_N]
set_property PACKAGE_PIN AE6 [get_ports CM_LVDS2_P]
set_property IOSTANDARD LVDS [get_ports CM_LVDS2_P]
set_property PACKAGE_PIN AF5 [get_ports CM_LVDS2_N]
set_property IOSTANDARD LVDS [get_ports CM_LVDS2_N]
set_property PACKAGE_PIN AG1 [get_ports CM_LVDS3_P]
set_property IOSTANDARD LVDS [get_ports CM_LVDS3_P]
set_property PACKAGE_PIN AH1 [get_ports CM_LVDS3_N]
set_property IOSTANDARD LVDS [get_ports CM_LVDS3_N]
set_property PACKAGE_PIN AJ11 [get_ports CM_GCLK_P]
set_property IOSTANDARD LVDS [get_ports CM_GCLK_P]
set_property PACKAGE_PIN AJ10 [get_ports CM_GCLK_N]
set_property IOSTANDARD LVDS [get_ports CM_GCLK_N]
#SWITCHES
set_property PACKAGE_PIN AD26 [get_ports USER_SW1]
set_property IOSTANDARD LVCMOS18 [get_ports USER_SW1]
set_property PACKAGE_PIN AE26 [get_ports USER_SW2]
set_property IOSTANDARD LVCMOS18 [get_ports USER_SW2]
set_property PACKAGE_PIN AC26 [get_ports USER_SW3]
set_property IOSTANDARD LVCMOS18 [get_ports USER_SW3]
set_property PACKAGE_PIN AC27 [get_ports USER_SW4]
set_property IOSTANDARD LVCMOS18 [get_ports USER_SW4]
set_property PACKAGE_PIN AE27 [get_ports USER_SW5]
set_property IOSTANDARD LVCMOS18 [get_ports USER_SW5]
set_property PACKAGE_PIN AF27 [get_ports USER_SW6]
set_property IOSTANDARD LVCMOS18 [get_ports USER_SW6]
set_property PACKAGE_PIN AG27 [get_ports USER_SW7]
set_property IOSTANDARD LVCMOS18 [get_ports USER_SW7]
set_property PACKAGE_PIN AH27 [get_ports USER_SW8]
set_property IOSTANDARD LVCMOS18 [get_ports USER_SW8]
#BUTTONS
set_property PACKAGE_PIN AL22 [get_ports USER_PB1]
set_property IOSTANDARD LVCMOS18 [get_ports USER_PB1]
set_property PACKAGE_PIN AM22 [get_ports USER_PB2]
set_property IOSTANDARD LVCMOS18 [get_ports USER_PB2]
#SMAs
set_property PACKAGE_PIN AK32 [get_ports CLK_DIFF_1_P]
set_property IOSTANDARD LVDS [get_ports CLK_DIFF_1_P]
set_property PACKAGE_PIN AL32 [get_ports CLK_DIFF_1_N]
set_property IOSTANDARD LVDS [get_ports CLK_DIFF_1_N]
set_property PACKAGE_PIN AK3 [get_ports CLK_DIFF_2_P]
set_property IOSTANDARD LVDS [get_ports CLK_DIFF_2_P]
set_property PACKAGE_PIN AL3 [get_ports CLK_DIFF_2_N]
set_property IOSTANDARD LVDS [get_ports CLK_DIFF_2_N]
#SYSTEM CLOCKS
set_property PACKAGE_PIN AL24 [get_ports LVDS_OSC_P]
set_property IOSTANDARD LVDS [get_ports LVDS_OSC_P]
set_property PACKAGE_PIN AL25 [get_ports LVDS_OSC_N]
set_property IOSTANDARD LVDS [get_ports LVDS_OSC_N]
#LEDs
set_property PACKAGE_PIN AH26 [get_ports APP_LED1]
set_property IOSTANDARD LVCMOS18 [get_ports APP_LED1]
set_property PACKAGE_PIN AJ26 [get_ports APP_LED2]
set_property IOSTANDARD LVCMOS18 [get_ports APP_LED2]
set_property PACKAGE_PIN AM25 [get_ports APP_LED3]

```

```

set_property IOSTANDARD LVCMOS18 [get_ports APP_LED3]
set_property PACKAGE_PIN AM26 [get_ports APP_LED4]
set_property IOSTANDARD LVCMOS18 [get_ports APP_LED4]
set_property PACKAGE_PIN AN26 [get_ports APP_LED5]
set_property IOSTANDARD LVCMOS18 [get_ports APP_LED5]
set_property PACKAGE_PIN AP26 [get_ports APP_LED6]
set_property IOSTANDARD LVCMOS18 [get_ports APP_LED6]
set_property PACKAGE_PIN AM24 [get_ports APP_LED7]
set_property IOSTANDARD LVCMOS18 [get_ports APP_LED7]
set_property PACKAGE_PIN AN24 [get_ports APP_LED8]
set_property IOSTANDARD LVCMOS18 [get_ports APP_LED8]
#IIC
set_property PACKAGE_PIN AF24 [get_ports DUT_I2C_SCL]
set_property IOSTANDARD LVCMOS18 [get_ports DUT_I2C_SCL]
set_property PACKAGE_PIN AG24 [get_ports DUT_I2C_SDA]
set_property IOSTANDARD LVCMOS18 [get_ports DUT_I2C_SDA]
#PMBUS
set_property PACKAGE_PIN AE25 [get_ports DUT_PMB_ALERT]
set_property IOSTANDARD LVCMOS18 [get_ports DUT_PMB_ALERT]
set_property PACKAGE_PIN AF25 [get_ports DUT_PMB_CTRL]
set_property IOSTANDARD LVCMOS18 [get_ports DUT_PMB_CTRL]
set_property PACKAGE_PIN AH23 [get_ports DUT_PMB_CLK]
set_property IOSTANDARD LVCMOS18 [get_ports DUT_PMB_CLK]
set_property PACKAGE_PIN AJ23 [get_ports DUT_PMB_DATA]
set_property IOSTANDARD LVCMOS18 [get_ports DUT_PMB_DATA]
#USB_GPIOs
set_property PACKAGE_PIN AD10 [get_ports USB_GPIO_0]
set_property IOSTANDARD LVCMOS18 [get_ports USB_GPIO_0]
set_property PACKAGE_PIN AC8 [get_ports USB_GPIO_1]
set_property IOSTANDARD LVCMOS18 [get_ports USB_GPIO_1]
set_property PACKAGE_PIN AD8 [get_ports USB_GPIO_2]
set_property IOSTANDARD LVCMOS18 [get_ports USB_GPIO_2]
set_property PACKAGE_PIN AK11 [get_ports USB_GPIO_3]
set_property IOSTANDARD LVCMOS18 [get_ports USB_GPIO_3]
#UART
set_property PACKAGE_PIN AK10 [get_ports USB_TXD_0]
set_property IOSTANDARD LVCMOS18 [get_ports USB_TXD_0]
set_property PACKAGE_PIN AL10 [get_ports USB_RXD_I]
set_property IOSTANDARD LVCMOS18 [get_ports USB_RXD_I]
set_property PACKAGE_PIN AL9 [get_ports USB_RTS_0_B]
set_property IOSTANDARD LVCMOS18 [get_ports USB_RTS_0_B]
set_property PACKAGE_PIN AG11 [get_ports USB_CTS_I_B]
set_property IOSTANDARD LVCMOS18 [get_ports USB_CTS_I_B]
#SYSTEMACE
set_property PACKAGE_PIN AE11 [get_ports SA2_SDHOST_D0]
set_property IOSTANDARD LVCMOS18 [get_ports SA2_SDHOST_D0]
set_property PACKAGE_PIN AE10 [get_ports SA2_SDHOST_D1]
set_property IOSTANDARD LVCMOS18 [get_ports SA2_SDHOST_D1]
set_property PACKAGE_PIN AF10 [get_ports SA2_SDHOST_D3]
set_property IOSTANDARD LVCMOS18 [get_ports SA2_SDHOST_D3]
set_property PACKAGE_PIN AG10 [get_ports SA2_SDHOST_D2]
set_property IOSTANDARD LVCMOS18 [get_ports SA2_SDHOST_D2]
set_property PACKAGE_PIN AH11 [get_ports SA2_SDHOST_CMD]
set_property IOSTANDARD LVCMOS18 [get_ports SA2_SDHOST_CMD]
set_property PACKAGE_PIN AE12 [get_ports SA2_SDHOST_CLK]
set_property IOSTANDARD LVCMOS18 [get_ports SA2_SDHOST_CLK]
#SPI - MGT PWR MODULE
set_property PACKAGE_PIN AC12 [get_ports MGT_MOD_SPI_SCK]
set_property IOSTANDARD LVCMOS18 [get_ports MGT_MOD_SPI_SCK]

```



```

set_property PACKAGE_PIN AC11 [get_ports MGT_MOD_SPI_D]
set_property IOSTANDARD LVCMOS18 [get_ports MGT_MOD_SPI_D]
set_property PACKAGE_PIN AC9 [get_ports MGT_MOD_SPI_Q]
set_property IOSTANDARD LVCMOS18 [get_ports MGT_MOD_SPI_Q]
set_property PACKAGE_PIN AD9 [get_ports GTH_MOD_SPI_CS]
set_property IOSTANDARD LVCMOS18 [get_ports GTH_MOD_SPI_CS]
set_property PACKAGE_PIN AD11 [get_ports GTZ_MOD_SPI_CS]
set_property IOSTANDARD LVCMOS18 [get_ports GTZ_MOD_SPI_CS]
#MGTs
set_property PACKAGE_PIN AC6 [get_ports 113_REFCLK0_P]
set_property PACKAGE_PIN AC5 [get_ports 113_REFCLK0_N]
set_property PACKAGE_PIN AA6 [get_ports 113_REFCLK1_P]
set_property PACKAGE_PIN AA5 [get_ports 113_REFCLK1_N]
set_property PACKAGE_PIN U2 [get_ports 113_TX3_P]
set_property PACKAGE_PIN U1 [get_ports 113_TX3_N]
set_property PACKAGE_PIN V4 [get_ports 113_RX3_P]
set_property PACKAGE_PIN V3 [get_ports 113_RX3_N]
set_property PACKAGE_PIN W2 [get_ports 113_TX2_P]
set_property PACKAGE_PIN AB4 [get_ports 113_RX2_P]
set_property PACKAGE_PIN W1 [get_ports 113_TX2_N]
set_property PACKAGE_PIN AB3 [get_ports 113_RX2_N]
set_property PACKAGE_PIN AA2 [get_ports 113_TX1_P]
set_property PACKAGE_PIN AD4 [get_ports 113_RX1_P]
set_property PACKAGE_PIN AA1 [get_ports 113_TX1_N]
set_property PACKAGE_PIN AD3 [get_ports 113_RX1_N]
set_property PACKAGE_PIN AC2 [get_ports 113_TX0_P]
set_property PACKAGE_PIN Y4 [get_ports 113_RX0_P]
set_property PACKAGE_PIN AC1 [get_ports 113_TX0_N]
set_property PACKAGE_PIN Y3 [get_ports 113_RX0_N]
set_property PACKAGE_PIN W6 [get_ports 114_REFCLK0_P]
set_property PACKAGE_PIN W5 [get_ports 114_REFCLK0_N]
set_property PACKAGE_PIN U6 [get_ports 114_REFCLK1_P]
set_property PACKAGE_PIN U5 [get_ports 114_REFCLK1_N]
set_property PACKAGE_PIN J2 [get_ports 114_TX3_P]
set_property PACKAGE_PIN J1 [get_ports 114_TX3_N]
set_property PACKAGE_PIN M4 [get_ports 114_RX3_P]
set_property PACKAGE_PIN M3 [get_ports 114_RX3_N]
set_property PACKAGE_PIN L2 [get_ports 114_TX2_P]
set_property PACKAGE_PIN L1 [get_ports 114_TX2_N]
set_property PACKAGE_PIN K4 [get_ports 114_RX2_P]
set_property PACKAGE_PIN K3 [get_ports 114_RX2_N]
set_property PACKAGE_PIN N2 [get_ports 114_TX1_P]
set_property PACKAGE_PIN N1 [get_ports 114_TX1_N]
set_property PACKAGE_PIN P4 [get_ports 114_RX1_P]
set_property PACKAGE_PIN P3 [get_ports 114_RX1_N]
set_property PACKAGE_PIN R2 [get_ports 114_TX0_P]
set_property PACKAGE_PIN R1 [get_ports 114_TX0_N]
set_property PACKAGE_PIN T4 [get_ports 114_RX0_P]
set_property PACKAGE_PIN T3 [get_ports 114_RX0_N]
set_property PACKAGE_PIN N6 [get_ports 115_REFCLK0_P]
set_property PACKAGE_PIN N5 [get_ports 115_REFCLK0_N]
set_property PACKAGE_PIN R6 [get_ports 115_REFCLK1_P]
set_property PACKAGE_PIN R5 [get_ports 115_REFCLK1_N]
set_property PACKAGE_PIN A2 [get_ports 115_TX3_P]
set_property PACKAGE_PIN A1 [get_ports 115_TX3_N]
set_property PACKAGE_PIN B4 [get_ports 115_RX3_P]
set_property PACKAGE_PIN B3 [get_ports 115_RX3_N]
set_property PACKAGE_PIN C2 [get_ports 115_TX2_P]
set_property PACKAGE_PIN C1 [get_ports 115_TX2_N]

```

```

set_property PACKAGE_PIN D4 [get_ports 115_RX2_P]
set_property PACKAGE_PIN D3 [get_ports 115_RX2_N]
set_property PACKAGE_PIN E2 [get_ports 115_TX1_P]
set_property PACKAGE_PIN E1 [get_ports 115_TX1_N]
set_property PACKAGE_PIN F4 [get_ports 115_RX1_P]
set_property PACKAGE_PIN F3 [get_ports 115_RX1_N]
set_property PACKAGE_PIN G2 [get_ports 115_TX0_P]
set_property PACKAGE_PIN G1 [get_ports 115_TX0_N]
set_property PACKAGE_PIN H4 [get_ports 115_RX0_P]
set_property PACKAGE_PIN H3 [get_ports 115_RX0_N]
set_property PACKAGE_PIN AC29 [get_ports 213_REFCLK0_P]
set_property PACKAGE_PIN AC30 [get_ports 213_REFCLK0_N]
set_property PACKAGE_PIN AA29 [get_ports 213_REFCLK1_P]
set_property PACKAGE_PIN AA30 [get_ports 213_REFCLK1_N]
set_property PACKAGE_PIN U33 [get_ports 213_TX3_P]
set_property PACKAGE_PIN U34 [get_ports 213_TX3_N]
set_property PACKAGE_PIN V31 [get_ports 213_RX3_P]
set_property PACKAGE_PIN V32 [get_ports 213_RX3_N]
set_property PACKAGE_PIN W33 [get_ports 213_TX2_P]
set_property PACKAGE_PIN W34 [get_ports 213_TX2_N]
set_property PACKAGE_PIN AB31 [get_ports 213_RX2_P]
set_property PACKAGE_PIN AB32 [get_ports 213_RX2_N]
set_property PACKAGE_PIN AA33 [get_ports 213_TX1_P]
set_property PACKAGE_PIN AA34 [get_ports 213_TX1_N]
set_property PACKAGE_PIN AD31 [get_ports 213_RX1_P]
set_property PACKAGE_PIN AD32 [get_ports 213_RX1_N]
set_property PACKAGE_PIN AC33 [get_ports 213_TX0_P]
set_property PACKAGE_PIN AC34 [get_ports 213_TX0_N]
set_property PACKAGE_PIN Y31 [get_ports 213_RX0_P]
set_property PACKAGE_PIN Y32 [get_ports 213_RX0_N]
set_property PACKAGE_PIN W29 [get_ports 214_REFCLK0_P]
set_property PACKAGE_PIN W30 [get_ports 214_REFCLK0_N]
set_property PACKAGE_PIN U29 [get_ports 214_REFCLK1_P]
set_property PACKAGE_PIN U30 [get_ports 214_REFCLK1_N]
set_property PACKAGE_PIN J33 [get_ports 214_TX3_P]
set_property PACKAGE_PIN J34 [get_ports 214_TX3_N]
set_property PACKAGE_PIN M31 [get_ports 214_RX3_P]
set_property PACKAGE_PIN M32 [get_ports 214_RX3_N]
set_property PACKAGE_PIN L33 [get_ports 214_TX2_P]
set_property PACKAGE_PIN L34 [get_ports 214_TX2_N]
set_property PACKAGE_PIN K31 [get_ports 214_RX2_P]
set_property PACKAGE_PIN K32 [get_ports 214_RX2_N]
set_property PACKAGE_PIN N33 [get_ports 214_TX1_P]
set_property PACKAGE_PIN N34 [get_ports 214_TX1_N]
set_property PACKAGE_PIN P31 [get_ports 214_RX1_P]
set_property PACKAGE_PIN P32 [get_ports 214_RX1_N]
set_property PACKAGE_PIN R33 [get_ports 214_TX0_P]
set_property PACKAGE_PIN R34 [get_ports 214_TX0_N]
set_property PACKAGE_PIN T31 [get_ports 214_RX0_P]
set_property PACKAGE_PIN T32 [get_ports 214_RX0_N]
set_property PACKAGE_PIN N29 [get_ports 215_REFCLK0_P]
set_property PACKAGE_PIN N30 [get_ports 215_REFCLK0_N]
set_property PACKAGE_PIN R29 [get_ports 215_REFCLK1_P]
set_property PACKAGE_PIN R30 [get_ports 215_REFCLK1_N]
set_property PACKAGE_PIN A33 [get_ports 215_TX3_P]
set_property PACKAGE_PIN A34 [get_ports 215_TX3_N]
set_property PACKAGE_PIN B31 [get_ports 215_RX3_P]
set_property PACKAGE_PIN B32 [get_ports 215_RX3_N]
set_property PACKAGE_PIN C33 [get_ports 215_TX2_P]

```

```
set_property PACKAGE_PIN C34 [get_ports 215_TX2_N]
set_property PACKAGE_PIN D31 [get_ports 215_RX2_P]
set_property PACKAGE_PIN D32 [get_ports 215_RX2_N]
set_property PACKAGE_PIN E33 [get_ports 215_TX1_P]
set_property PACKAGE_PIN E34 [get_ports 215_TX1_N]
set_property PACKAGE_PIN F31 [get_ports 215_RX1_P]
set_property PACKAGE_PIN F32 [get_ports 215_RX1_N]
set_property PACKAGE_PIN G33 [get_ports 215_TX0_P]
set_property PACKAGE_PIN G34 [get_ports 215_TX0_N]
set_property PACKAGE_PIN H31 [get_ports 215_RX0_P]
set_property PACKAGE_PIN H32 [get_ports 215_RX0_N]
set_property PACKAGE_PIN E17 [get_ports 300_REFCLK0_P]
set_property PACKAGE_PIN E16 [get_ports 300_REFCLK0_N]
set_property PACKAGE_PIN E21 [get_ports 300_REFCLK1_P]
set_property PACKAGE_PIN E20 [get_ports 300_REFCLK1_N]
set_property PACKAGE_PIN C29 [get_ports 300_TX0_P]
set_property PACKAGE_PIN C28 [get_ports 300_TX0_N]
set_property PACKAGE_PIN A28 [get_ports 300_TX1_P]
set_property PACKAGE_PIN A27 [get_ports 300_TX1_N]
set_property PACKAGE_PIN C26 [get_ports 300_TX2_P]
set_property PACKAGE_PIN C25 [get_ports 300_TX2_N]
set_property PACKAGE_PIN A25 [get_ports 300_TX3_P]
set_property PACKAGE_PIN A24 [get_ports 300_TX3_N]
set_property PACKAGE_PIN C17 [get_ports 300_TX4_P]
set_property PACKAGE_PIN C16 [get_ports 300_TX4_N]
set_property PACKAGE_PIN A16 [get_ports 300_TX5_P]
set_property PACKAGE_PIN A15 [get_ports 300_TX5_N]
set_property PACKAGE_PIN C14 [get_ports 300_TX6_P]
set_property PACKAGE_PIN C13 [get_ports 300_TX6_N]
set_property PACKAGE_PIN A13 [get_ports 300_TX7_P]
set_property PACKAGE_PIN A12 [get_ports 300_TX7_N]
set_property PACKAGE_PIN C23 [get_ports 300_RX0_P]
set_property PACKAGE_PIN C22 [get_ports 300_RX0_N]
set_property PACKAGE_PIN A22 [get_ports 300_RX1_P]
set_property PACKAGE_PIN A21 [get_ports 300_RX1_N]
set_property PACKAGE_PIN C20 [get_ports 300_RX2_P]
set_property PACKAGE_PIN C19 [get_ports 300_RX2_N]
set_property PACKAGE_PIN A19 [get_ports 300_RX3_P]
set_property PACKAGE_PIN A18 [get_ports 300_RX3_N]
set_property PACKAGE_PIN C11 [get_ports 300_RX4_P]
set_property PACKAGE_PIN C10 [get_ports 300_RX4_N]
set_property PACKAGE_PIN A10 [get_ports 300_RX5_P]
set_property PACKAGE_PIN A9 [get_ports 300_RX5_N]
set_property PACKAGE_PIN C8 [get_ports 300_RX6_P]
set_property PACKAGE_PIN C7 [get_ports 300_RX6_N]
set_property PACKAGE_PIN A7 [get_ports 300_RX7_P]
set_property PACKAGE_PIN A6 [get_ports 300_RX7_N]
```

Additional Resources

Xilinx Resources

For support resources such as Answers, Documentation, Downloads, and Forums, see the [Xilinx Support website](#).

For continual updates, add the Answer Record to your [myAlerts](#).

Solution Centers

See the [Xilinx Solution Centers](#) for support on devices, software tools, and intellectual property at all stages of the design cycle. Topics include design assistance, advisories, and troubleshooting tips.

References

The most up to date information related to the VC7222 kit and its documentation is available on these websites.

[Virtex-7 FPGA VC7222 Characterization Kit](#)

[Virtex-7 FPGA VC7222 Characterization Kit documentation](#)

[Virtex-7 FPGA VC7222 Characterization Kit Master Answer Record \(AR 54015\)](#)

These Xilinx documents and sites provide supplemental material useful with this guide:

1. *7 Series FPGAs and Zynq-7000 All Programmable SoC XADC Dual 12-Bit 1 MSPS Analog-to-Digital Converter User Guide* ([UG480](#))
2. Information about the power system components used by the VC7222 board is available from the Texas Instruments digital power website at:
www.ti.com/ww/en/analog/digital-power/index.html
3. Information about the 7 series GTH and GTZ power supply modules included with the VC7222 Characterization Kit is available from the following vendors:
Texas Instruments: www.ti.com/tool/pmp6577.1
Bellnix: www.bellnix.com/gold/BPE-37.html
4. *Vivado Design Suite User Guide: Using Constraints* ([UG903](#))
5. *7 Series FPGAs Overview* ([DS180](#))
6. *Virtex-7 T and XT FPGAs Data Sheet: DC and Switching Characteristics* ([DS183](#))
7. *7 Series FPGAs Configuration User Guide* ([UG470](#))
8. *7 Series FPGAs SelectIO Resources User Guide* ([UG471](#))

9. *7 Series FPGAs Clocking Resources User Guide* ([UG472](#))
10. *7 Series FPGAs Configurable Logic Block User Guide* ([UG474](#))
11. *7 Series FPGAs Packaging and Pinout Product Specification* ([UG475](#))
12. *7 Series FPGAs GTX/GTH Transceivers User Guide* ([UG476](#))
13. *7 Series FPGAs GTZ Transceivers Advance Specification User Guide* (UG478)
14. *HW-CLK-101-SCLK2 SuperClock-2 Module User Guide* ([UG770](#))
15. *Virtex-7 FPGA VC7222 IBERT Getting Started Guide (Vivado Design Suite)* ([UG971](#))
16. *7 Series FPGAs Integrated Block for PCI Express v1.8 User Guide* ([PG054](#))
17. Information about GTZ Transceivers is available in the [7 Series FPGAs GTZ Transceivers Lounge](#).

Regulatory and Compliance Information

This product is designed and tested to conform to the European Union directives and standards described in this section.

Declaration of Conformity

See the [Virtex-7 FPGA VC7222 Declaration of Conformity](#).

Directives

2006/95/EC, *Low Voltage Directive (LVD)*

2004/108/EC, *Electromagnetic Compatibility (EMC) Directive*

Standards

EN standards are maintained by the European Committee for Electrotechnical Standardization (CENELEC). IEC standards are maintained by the International Electrotechnical Commission (IEC).

Electromagnetic Compatibility

EN 55022:2010, *Information Technology Equipment Radio Disturbance Characteristics – Limits and Methods of Measurement*

EN 55024:2010, *Information Technology Equipment Immunity Characteristics – Limits and Methods of Measurement*

This is a Class A product and can cause radio interference. In a domestic environment, the user might be required to take adequate corrective measures.

Safety

IEC 60950-1:2005, *Information technology equipment – Safety, Part 1: General requirements*

EN 60950-1:2006, *Information technology equipment – Safety, Part 1: General requirements*

Markings



This product complies with Directive 2002/96/EC on waste electrical and electronic equipment (WEEE). The affixed product label indicates that the user must not discard this electrical or electronic product in domestic household waste.



This product complies with Directive 2002/95/EC on the restriction of hazardous substances (RoHS) in electrical and electronic equipment.



This product complies with CE Directives 2006/95/EC, *Low Voltage Directive (LVD)* and 2004/108/EC, *Electromagnetic Compatibility (EMC) Directive*.

Компания «Life Electronics» занимается поставками электронных компонентов импортного и отечественного производства от производителей и со складов крупных дистрибьюторов Европы, Америки и Азии.

С конца 2013 года компания активно расширяет линейку поставок компонентов по направлению коаксиальный кабель, кварцевые генераторы и конденсаторы (керамические, пленочные, электролитические), за счёт заключения дистрибьюторских договоров

Мы предлагаем:

- Конкуренспособные цены и скидки постоянным клиентам.
- Специальные условия для постоянных клиентов.
- Подбор аналогов.
- Поставку компонентов в любых объемах, удовлетворяющих вашим потребностям.
- Приемлемые сроки поставки, возможна ускоренная поставка.
- Доставку товара в любую точку России и стран СНГ.
- Комплексную поставку.
- Работу по проектам и поставку образцов.
- Формирование склада под заказчика.
- Сертификаты соответствия на поставляемую продукцию (по желанию клиента).
- Тестирование поставляемой продукции.
- Поставку компонентов, требующих военную и космическую приемку.
- Входной контроль качества.
- Наличие сертификата ISO.

В составе нашей компании организован Конструкторский отдел, призванный помогать разработчикам, и инженерам.

Конструкторский отдел помогает осуществить:

- Регистрацию проекта у производителя компонентов.
- Техническую поддержку проекта.
- Защиту от снятия компонента с производства.
- Оценку стоимости проекта по компонентам.
- Изготовление тестовой платы монтаж и пусконаладочные работы.



Тел: +7 (812) 336 43 04 (многоканальный)

Email: org@lifeelectronics.ru