

Silicon PIN Photodiode



DESCRIPTION

VEMD8080 is a high speed and high sensitive PIN photodiode with enhanced sensitivity for visible light. It is a low profile surface-mount device (SMD) including the chip with a 4.5 mm² sensitive area detecting visible and near infrared radiation.

FEATURES

- Package type: surface-mount
- Package form: top view
- Dimensions (L x W x H in mm): 4.8 x 2.5 x 0.48
- Radiant sensitive area (in mm²): 4.5
- 0.48 mm low profile package
- Enhanced sensitivity for visible light
- Suitable for visible and near infrared radiation
- Fast response times
- Angle of half sensitivity: $\phi = \pm 65^\circ$
- Floor life: 168 h, MSL 3, according to J-STD-020
- Material categorization: for definitions of compliance please see www.vishay.com/doc?99912



APPLICATIONS

- High speed photo detector
- Wearables

PRODUCT SUMMARY

COMPONENT	I_{ra} (μA)	ϕ (deg)	$\lambda_{0.1}$ (nm)
VEMD8080	28	± 65	350 to 1100

Note

- Test conditions see table “Basic Characteristics”

ORDERING INFORMATION

ORDERING CODE	PACKAGING	REMARKS	PACKAGE FORM
VEMD8080	Tape and reel	MOQ: 5000 pcs, 5000 pcs/reel	Top view

Note

- MOQ: minimum order quantity

ABSOLUTE MAXIMUM RATINGS ($T_{amb} = 25^\circ C$, unless otherwise specified)

PARAMETER	TEST CONDITION	SYMBOL	VALUE	UNIT
Reverse voltage		V_R	20	V
Junction temperature		T_j	85	$^\circ C$
Operating temperature range		T_{amb}	-40 to +85	$^\circ C$
Storage temperature range		T_{stg}	-40 to +85	$^\circ C$
Soldering temperature	According to reflow solder profile Fig. 8	T_{sd}	260	$^\circ C$
Thermal resistance junction-to-ambient		R_{thJA}	350	K/W
ESD safety HBM	± 2000 V, 1.5 k Ω , 100 pF, 3 pulses	ESD_{HBM}	≥ 2	kV

BASIC CHARACTERISTICS ($T_{amb} = 25\text{ }^{\circ}\text{C}$, unless otherwise specified)						
PARAMETER	TEST CONDITION	SYMBOL	MIN.	TYP.	MAX.	UNIT
Forward voltage	$I_F = 50\text{ mA}$	V_F	-	1.2	1.6	V
Breakdown voltage	$I_R = 100\text{ }\mu\text{A}$, $E = 0$	$V_{(BR)}$	20	-	-	V
Reverse dark current	$V_R = 10\text{ V}$, $E = 0$	I_{ro}	-	0.2	10	nA
Diode capacitance	$V_R = 0\text{ V}$, $f = 1\text{ MHz}$, $E = 0$	C_D	-	47	-	pF
	$V_R = 3\text{ V}$, $f = 1\text{ MHz}$, $E = 0$	C_D	-	17	40	pF
Open circuit voltage	$E_e = 1\text{ mW/cm}^2$, $\lambda = 950\text{ nm}$	V_o	-	320	-	mV
Temperature coefficient of V_o	$E_e = 1\text{ mW/cm}^2$, $\lambda = 950\text{ nm}$	TK_{V_o}	-	-3.0	-	mV/K
Short circuit current	$E_e = 1\text{ mW/cm}^2$, $\lambda = 950\text{ nm}$	I_k	-	32	-	μA
Temperature coefficient of I_k	$E_e = 1\text{ mW/cm}^2$, $\lambda = 950\text{ nm}$	TK_{I_k}	-	0.1	-	%/K
Reverse light current	$E_e = 1\text{ mW/cm}^2$, $\lambda = 850\text{ nm}$, $V_R = 5\text{ V}$	I_{ra}	23	28	33	μA
	$E_e = 0.25\text{ mW/cm}^2$, $\lambda = 525\text{ nm}$, $V_R = 5\text{ V}$	I_{ra}	3.4	4.4	5.3	μA
Angle of half sensitivity		ϕ	-	± 65	-	deg
Wavelength of peak sensitivity		λ_p	-	850	-	nm
Range of spectral bandwidth		$\lambda_{0.1}$	-	350 to 1100	-	nm
Rise time	$V_R = 10\text{ V}$, $R_L = 1\text{ k}\Omega$, $\lambda = 830\text{ nm}$	t_r	-	70	-	ns
Fall time	$V_R = 10\text{ V}$, $R_L = 1\text{ k}\Omega$, $\lambda = 830\text{ nm}$	t_f	-	70	-	ns

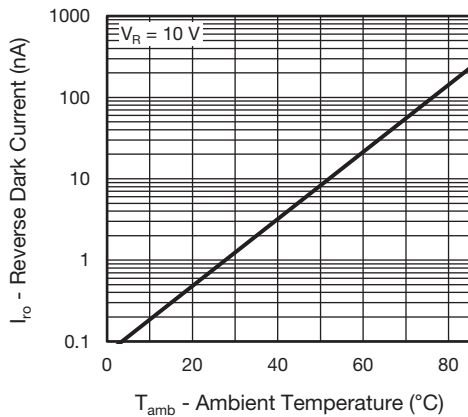
BASIC CHARACTERISTICS ($T_{amb} = 25\text{ }^{\circ}\text{C}$, unless otherwise specified)


Fig. 1 - Reverse Dark Current vs. Ambient Temperature

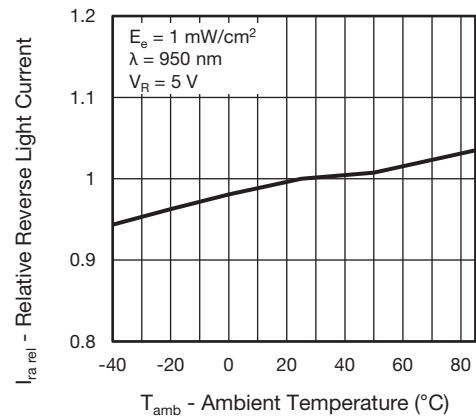


Fig. 2 - Relative Reverse Light Current vs. Ambient Temperature

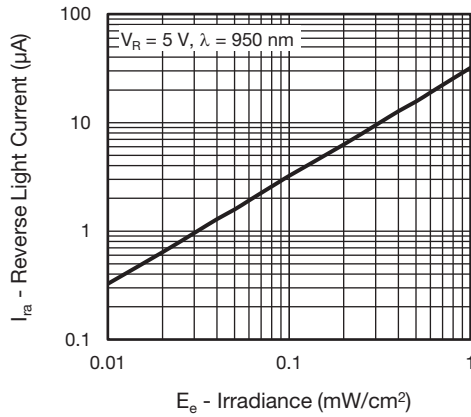


Fig. 3 - Reverse Light Current vs. Irradiance

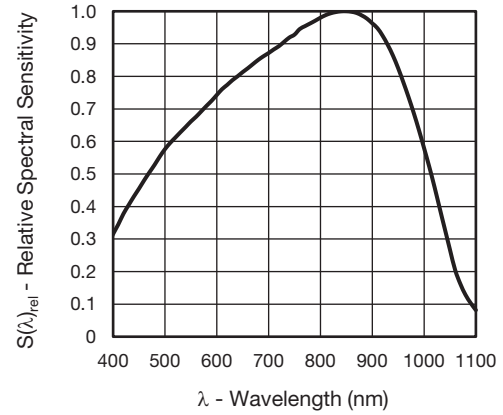


Fig. 5 - Relative Spectral Sensitivity vs. Wavelength

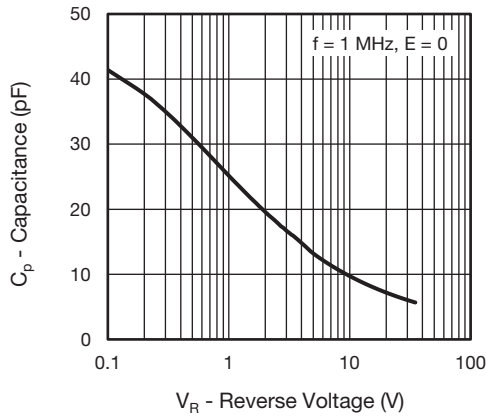


Fig. 4 - Diode Capacitance vs. Reverse Voltage

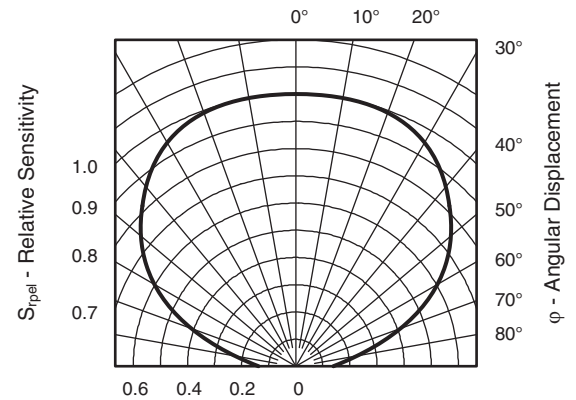
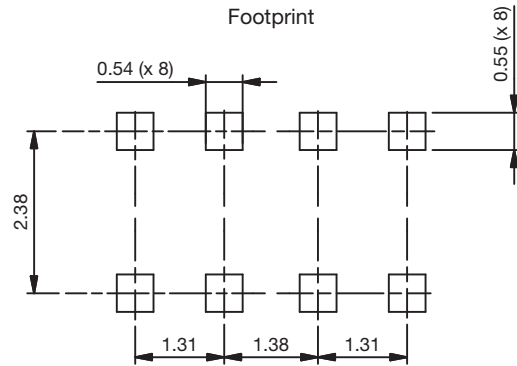
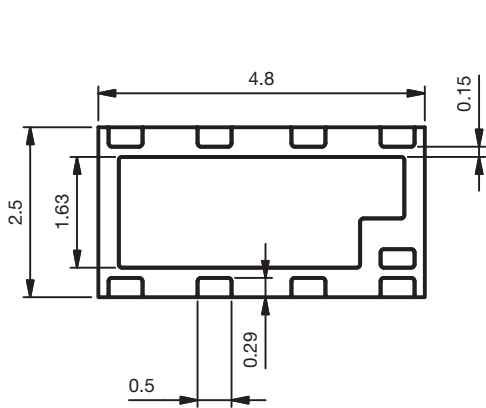


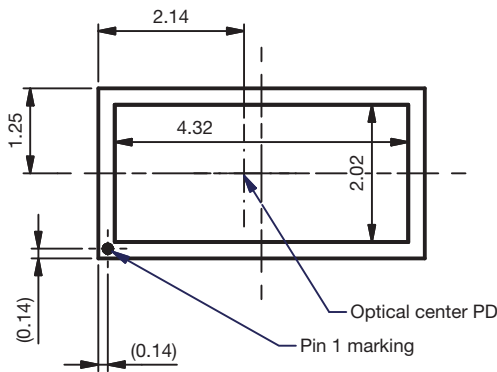
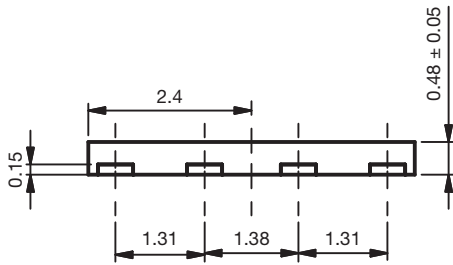
Fig. 6 - Relative Sensitivity vs. Angular Displacement



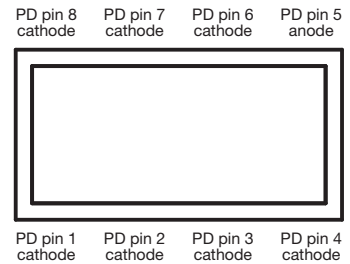
PACKAGE DIMENSIONS in millimeters



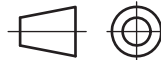
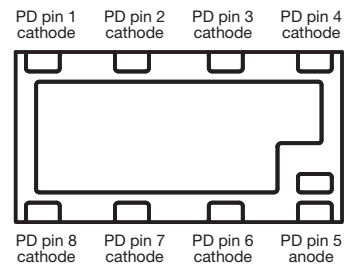
Not indicated tolerances ± 0.1 mm



Pinning top view



Pinning bottom view



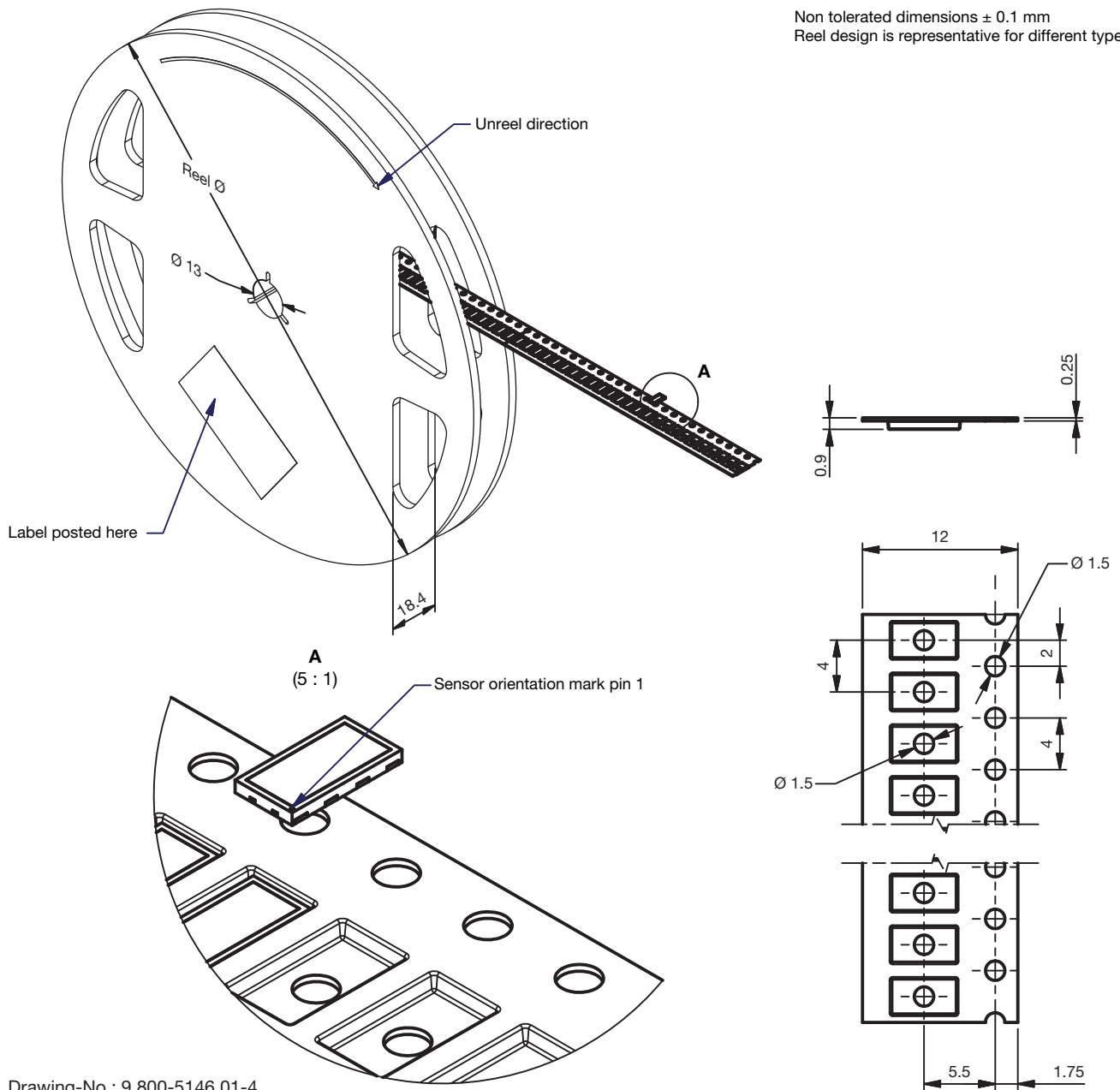
Technical drawings according to DIN specification.

Drawing number: 6.550-5354.01-4
Issue: 1; 20.04.2018



TAPE AND REEL DIMENSIONS in millimeters

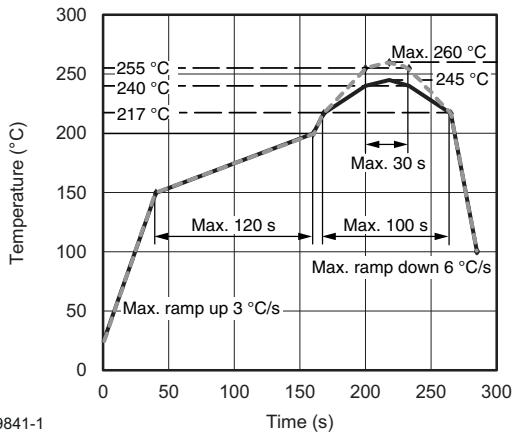
Non tolerated dimensions ± 0.1 mm
Reel design is representative for different types



Drawing-No.: 9.800-5146.01-4
Issue: 1; 20.04.2018



SOLDER PROFILE



19841-1

Fig. 7 - Lead (Pb)-free Reflow Solder Profile According to J-STD-020D

DRYPACK

Devices are packed in moisture barrier bags (MBB) to prevent the products from moisture absorption during transportation and storage. Each bag contains a desiccant.

FLOOR LIFE

Time between soldering and removing from MBB must not exceed the time indicated in J-STD-020:

Moisture sensitivity: level 3

Floor life: 168 h

Conditions: $T_{amb} < 30\text{ °C}$, $RH < 60\%$

DRYING

In case of moisture absorption devices should be baked before soldering. Conditions see J-STD-020 or recommended conditions:

192 h at $40\text{ °C} (+ 5\text{ °C})$, $RH < 5\%$

or

96 h at $60\text{ °C} (+ 5\text{ °C})$, $RH < 5\%$



Disclaimer

ALL PRODUCT, PRODUCT SPECIFICATIONS AND DATA ARE SUBJECT TO CHANGE WITHOUT NOTICE TO IMPROVE RELIABILITY, FUNCTION OR DESIGN OR OTHERWISE.

Vishay Intertechnology, Inc., its affiliates, agents, and employees, and all persons acting on its or their behalf (collectively, "Vishay"), disclaim any and all liability for any errors, inaccuracies or incompleteness contained in any datasheet or in any other disclosure relating to any product.

Vishay makes no warranty, representation or guarantee regarding the suitability of the products for any particular purpose or the continuing production of any product. To the maximum extent permitted by applicable law, Vishay disclaims (i) any and all liability arising out of the application or use of any product, (ii) any and all liability, including without limitation special, consequential or incidental damages, and (iii) any and all implied warranties, including warranties of fitness for particular purpose, non-infringement and merchantability.

Statements regarding the suitability of products for certain types of applications are based on Vishay's knowledge of typical requirements that are often placed on Vishay products in generic applications. Such statements are not binding statements about the suitability of products for a particular application. It is the customer's responsibility to validate that a particular product with the properties described in the product specification is suitable for use in a particular application. Parameters provided in datasheets and / or specifications may vary in different applications and performance may vary over time. All operating parameters, including typical parameters, must be validated for each customer application by the customer's technical experts. Product specifications do not expand or otherwise modify Vishay's terms and conditions of purchase, including but not limited to the warranty expressed therein.

Except as expressly indicated in writing, Vishay products are not designed for use in medical, life-saving, or life-sustaining applications or for any other application in which the failure of the Vishay product could result in personal injury or death. Customers using or selling Vishay products not expressly indicated for use in such applications do so at their own risk. Please contact authorized Vishay personnel to obtain written terms and conditions regarding products designed for such applications.

No license, express or implied, by estoppel or otherwise, to any intellectual property rights is granted by this document or by any conduct of Vishay. Product names and markings noted herein may be trademarks of their respective owners.

Компания «Life Electronics» занимается поставками электронных компонентов импортного и отечественного производства от производителей и со складов крупных дистрибьюторов Европы, Америки и Азии.

С конца 2013 года компания активно расширяет линейку поставок компонентов по направлению коаксиальный кабель, кварцевые генераторы и конденсаторы (керамические, пленочные, электролитические), за счёт заключения дистрибьюторских договоров

Мы предлагаем:

- Конкурентоспособные цены и скидки постоянным клиентам.
- Специальные условия для постоянных клиентов.
- Подбор аналогов.
- Поставку компонентов в любых объемах, удовлетворяющих вашим потребностям.
- Приемлемые сроки поставки, возможна ускоренная поставка.
- Доставку товара в любую точку России и стран СНГ.
- Комплексную поставку.
- Работу по проектам и поставку образцов.
- Формирование склада под заказчика.
- Сертификаты соответствия на поставляемую продукцию (по желанию клиента).
- Тестирование поставляемой продукции.
- Поставку компонентов, требующих военную и космическую приемку.
- Входной контроль качества.
- Наличие сертификата ISO.

В составе нашей компании организован Конструкторский отдел, призванный помогать разработчикам, и инженерам.

Конструкторский отдел помогает осуществить:

- Регистрацию проекта у производителя компонентов.
- Техническую поддержку проекта.
- Защиту от снятия компонента с производства.
- Оценку стоимости проекта по компонентам.
- Изготовление тестовой платы монтаж и пусконаладочные работы.



Тел: +7 (812) 336 43 04 (многоканальный)

Email: org@lifeelectronics.ru