

## Applications

- Military radar
- Civilian radar
- Professional and military radio communications
- Test instrumentation
- Wideband or narrowband amplifiers
- Jammers



## Product Features

- Frequency: DC to 6 GHz
- Output Power ( $P_{3dB}$ ): 17 W at 3.3 GHz
- Linear Gain: >15 dB at 3.3 GHz
- Operating Voltage: 28 V
- Low thermal resistance package

## Functional Block Diagram

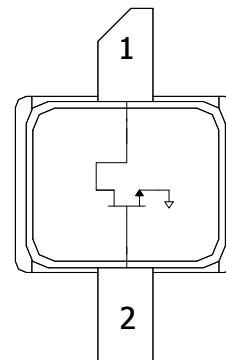

## General Description

The TriQuint T2G6001528-SG is a 15W ( $P_{3dB}$ ) discrete GaN on SiC HEMT which operates from DC to 6.0 GHz. The device is constructed with TriQuint's proven TQGaN25 process, which features advanced field plate techniques to optimize power and efficiency at high drain bias operating conditions. This optimization can potentially lower system costs in terms of fewer amplifier line-ups and lower thermal management costs.

Lead-free and ROHS compliant

Evaluation boards are available upon request.

## Pin Configuration

Pin No.	Label
1	$V_D$ / RF OUT
2	$V_G$ / RF IN
Flange	Source

## Ordering Information

Part	ECCN	Description
T2G6001528-SG	EAR99	Packaged part Flangeless
T2G6001528-SG-EVB1	EAR99	3.1 – 3.5 GHz Evaluation Board

## Absolute Maximum Ratings

Parameter	Value
Breakdown Voltage ( $V_{DG}$ )	100 V
Gate Voltage Range ( $V_G$ )	-7 to 0 V
Drain Current ( $I_D$ )	5 A
Gate Current ( $I_G$ )	-5 to 14 mA
Power Dissipation ( $P_D$ )	28 W
RF Input Power, CW, $T = 25^\circ\text{C}$ ( $P_{IN}$ )	36 dBm
Channel Temperature ( $T_{CH}$ )	275 °C
Mounting Temperature (30 Seconds)	320 °C
Storage Temperature	-40 to 150 °C

Operation of this device outside the parameter ranges given above may cause permanent damage. These are stress ratings only, and functional operation of the device at these conditions is not implied.

## Recommended Operating Conditions

Parameter	Value
Drain Voltage ( $V_D$ )	28 V (Typ.)
Drain Quiescent Current ( $I_{DQ}$ )	100 mA (Typ.)
Peak Drain Current ( $I_D$ )	1400 mA (Typ.)
Gate Voltage ( $V_G$ )	-3.2 V (Typ.)
Channel Temperature ( $T_{CH}$ )	225 °C (Max)
Power Dissipation, CW ( $P_D$ )	20.9 W (Max)
Power Dissipation, Pulse ( $P_D$ )	22.5 W (Max)

Electrical specifications are measured at specified test conditions. Specifications are not guaranteed over all recommended operating conditions.

## RF Characterization – Load Pull Performance at 1.0 GHz

Test conditions unless otherwise noted:  $T_A = 25^\circ\text{C}$ ,  $V_D = 28\text{ V}$ ,  $I_{DQ} = 100\text{ mA}$ , Pulse: 100uS Pulse Width, 20% Duty Cycle

Symbol	Parameter	Min	Typical	Max	Units
$G_{LIN}$	Linear Gain, Power Tuned		24		dB
$P_{3dB}$	Output Power at 3 dB Gain Compression, Power Tuned		18		W
$PAE_{3dB}$	Power-Added Efficiency at 3 dB Gain Compression, Efficiency Tuned		76.9		%
$G_{3dB}$	Gain at 3 dB Compression, Power Tuned		21		dB

## RF Characterization – Load Pull Performance at 2.0 GHz

Test conditions unless otherwise noted:  $T_A = 25^\circ\text{C}$ ,  $V_D = 28\text{ V}$ ,  $I_{DQ} = 100\text{ mA}$ , Pulse: 100uS Pulse Width, 20% Duty Cycle

Symbol	Parameter	Min	Typical	Max	Units
$G_{LIN}$	Linear Gain, Power Tuned		18.5		dB
$P_{3dB}$	Output Power at 3 dB Gain Compression, Power Tuned		18.6		W
$PAE_{3dB}$	Power-Added Efficiency at 3 dB Gain Compression, Efficiency Tuned		61.5		%
$G_{3dB}$	Gain at 3 dB Compression, Power Tuned		15.5		dB

**RF Characterization – Load Pull Performance at 3.0 GHz**

 Test conditions unless otherwise noted:  $T_A = 25\text{ }^\circ\text{C}$ ,  $V_D = 28\text{ V}$ ,  $I_{DQ} = 100\text{ mA}$ , Pulse: 100uS Pulse Width, 20% Duty Cycle

Symbol	Parameter	Min	Typical	Max	Units
$G_{LIN}$	Linear Gain, Power Tuned		15.1		dB
$P_{3dB}$	Output Power at 3 dB Gain Compression, Power Tuned		19.5		W
$PAE_{3dB}$	Power-Added Efficiency at 3 dB Gain Compression, Efficiency Tuned		64.1		%
$G_{3dB}$	Gain at 3 dB Compression, Power Tuned		12.1		dB

**RF Characterization – Load Pull Performance at 4.0 GHz**

 Test conditions unless otherwise noted:  $T_A = 25\text{ }^\circ\text{C}$ ,  $V_D = 28\text{ V}$ ,  $I_{DQ} = 100\text{ mA}$ , Pulse: 100uS Pulse Width, 20% Duty Cycle

Symbol	Parameter	Min	Typical	Max	Units
$G_{LIN}$	Linear Gain, Power Tuned		12.6		dB
$P_{3dB}$	Output Power at 3 dB Gain Compression, Power Tuned		19.6		W
$PAE_{3dB}$	Power-Added Efficiency at 3 dB Gain Compression, Efficiency Tuned		63.8		%
$G_{3dB}$	Gain at 3 dB Compression, Power Tuned		9.6		dB

**RF Characterization – Load Pull Performance at 5.0 GHz**

 Test conditions unless otherwise noted:  $T_A = 25\text{ }^\circ\text{C}$ ,  $V_D = 28\text{ V}$ ,  $I_{DQ} = 100\text{ mA}$ , Pulse: 100uS Pulse Width, 20% Duty Cycle

Symbol	Parameter	Min	Typical	Max	Units
$G_{LIN}$	Linear Gain, Power Tuned		13.3		dB
$P_{3dB}$	Output Power at 3 dB Gain Compression, Power Tuned		20		W
$PAE_{3dB}$	Power-Added Efficiency at 3 dB Gain Compression, Efficiency Tuned		60.8		%
$G_{3dB}$	Gain at 3 dB Compression, Power Tuned		10.3		dB

**RF Characterization – Load Pull Performance at 6.0 GHz**

 Test conditions unless otherwise noted:  $T_A = 25\text{ }^\circ\text{C}$ ,  $V_D = 28\text{ V}$ ,  $I_{DQ} = 100\text{ mA}$ , Pulse: 100uS Pulse Width, 20% Duty Cycle

Symbol	Parameter	Min	Typical	Max	Units
$G_{LIN}$	Linear Gain, Power Tuned		11.6		dB
$P_{3dB}$	Output Power at 3 dB Gain Compression, Power Tuned		20		W
$PAE_{3dB}$	Power-Added Efficiency at 3 dB Gain Compression, Efficiency Tuned		60.7		%
$G_{3dB}$	Gain at 3 dB Compression, Power Tuned		8.6		dB

### RF Characterization – EVB Performance at 3.3 GHz

Test conditions unless otherwise noted:  $T_A = 25\text{ °C}$ ,  $V_D = 28\text{ V}$ ,  $I_{DQ} = 100\text{ mA}$ , Pulse: 100uS Pulse Width, 20% Duty Cycle

Symbol	Parameter	Min	Typical	Max	Units
$G_{LIN}$	Linear Gain	14.5	15.5		dB
$P_{3dB}$	Output Power at 3 dB Gain Compression	15.5	17		W
$DE_{3dB}$	Drain Efficiency at 3 dB Gain Compression	68	72		%
$G_{3dB}$	Gain at 3 dB Compression	11.5	12.5		dB

### RF Characterization – Narrow Band Performance at 3.30 GHz

Test conditions unless otherwise noted:  $T_A = 25\text{ °C}$ ,  $V_D = 28\text{ V}$ ,  $I_{DQ} = 100\text{ mA}$   
 Driving input power is determined at 1dB compression at EVB output connector.

Symbol	Parameter	Typical
VSWR	Impedance Mismatch Ruggedness	10:1

### Thermal and Reliability Information

Parameter	Test Conditions	Value	Units
Thermal Resistance ( $\theta_{JC}$ )	DC at 85 °C Case	6.7	°C/W
Channel Temperature ( $T_{CH}$ )		225	°C

Notes:

Thermal resistance measured to bottom of package, CW.

### Median Lifetime

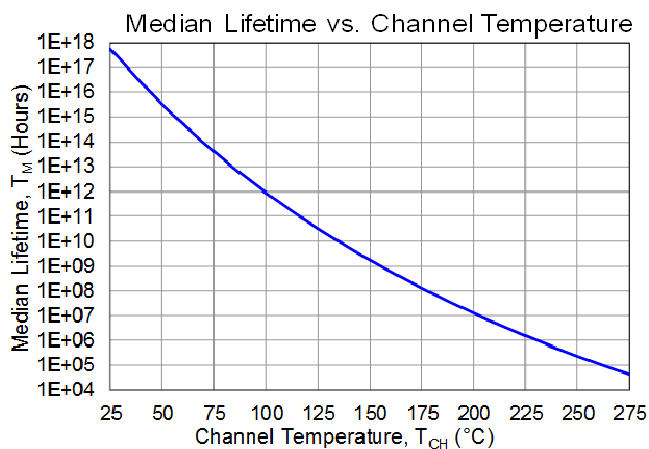

### Maximum Channel Temperature

$T_{BASE} = 85^\circ\text{C}$ ,  $P_{diss} = 22.5\text{W}$

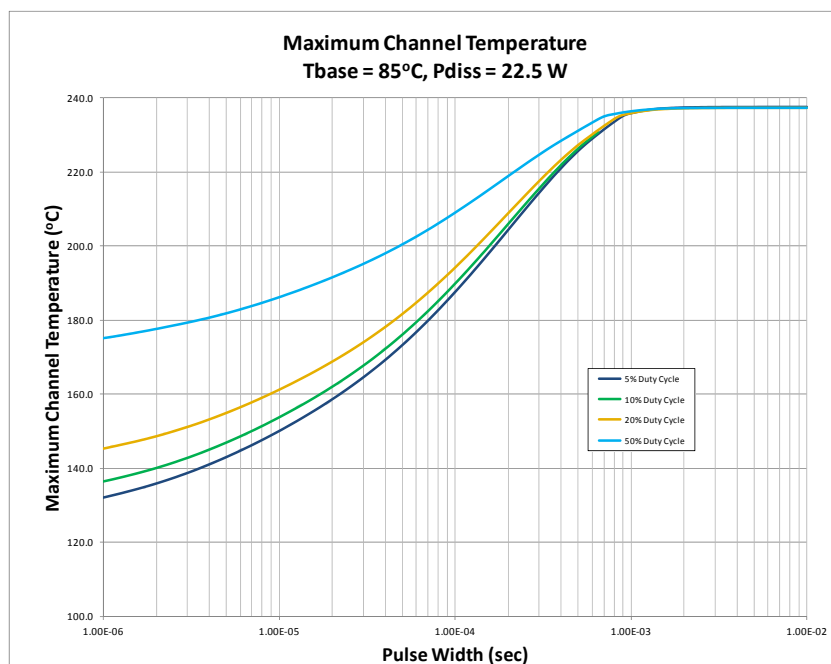

**Load Pull Smith Charts (1, 2)**

RF performance that the device typically exhibits when placed in the specified impedance environment. The impedances are not the impedances of the device, they are the impedances presented to the device via an RF circuit or load-pull system. The impedances listed follow an optimized trajectory to maintain high power and high efficiency.

Notes:

1. 28V, 100mA, Pulsed signal with 100uS pulse width and 20% duty cycle
2. See page 15 for load pull and source pull reference planes.

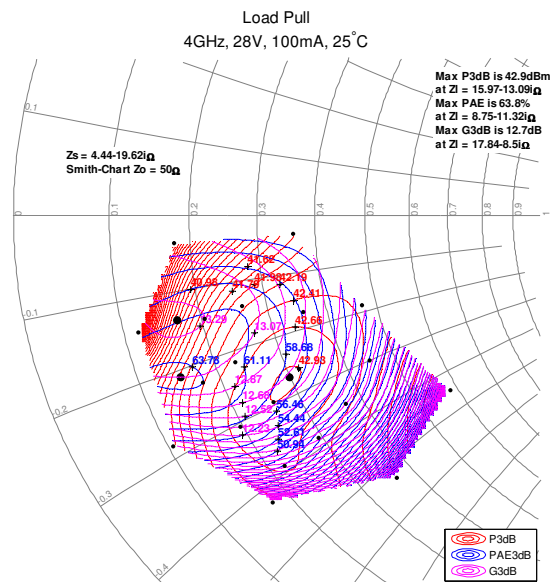
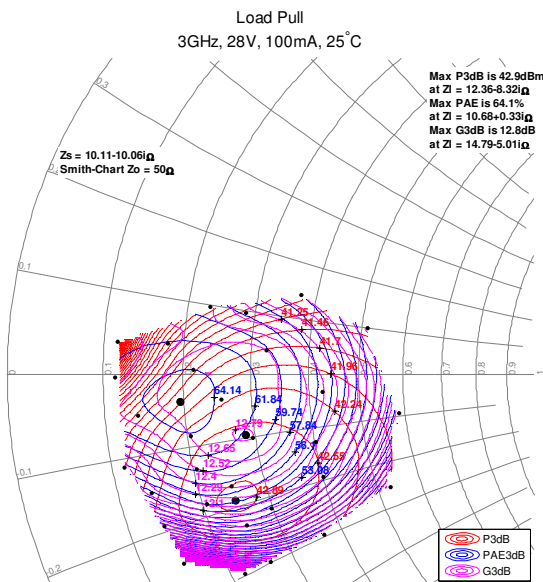
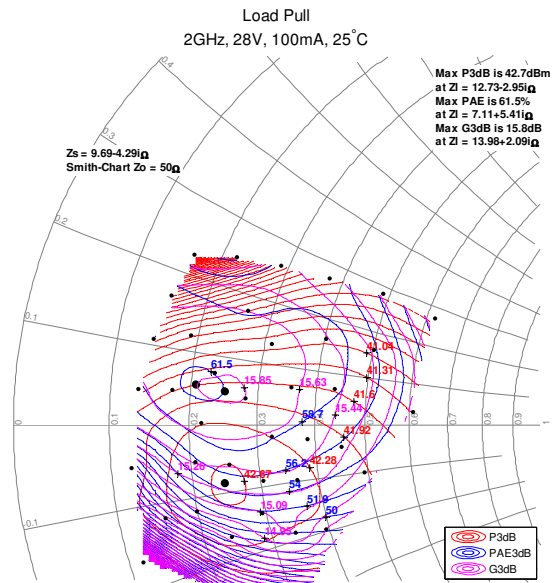
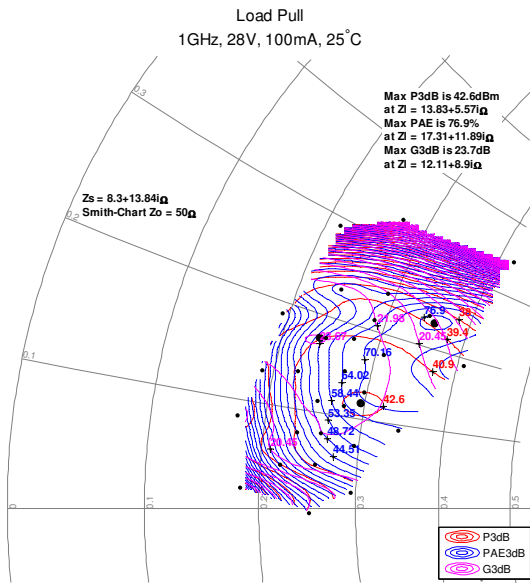

**Load Pull Smith Charts (1, 2)**

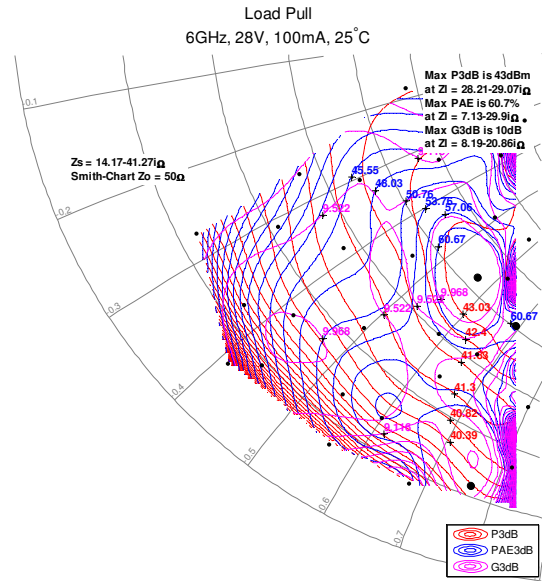
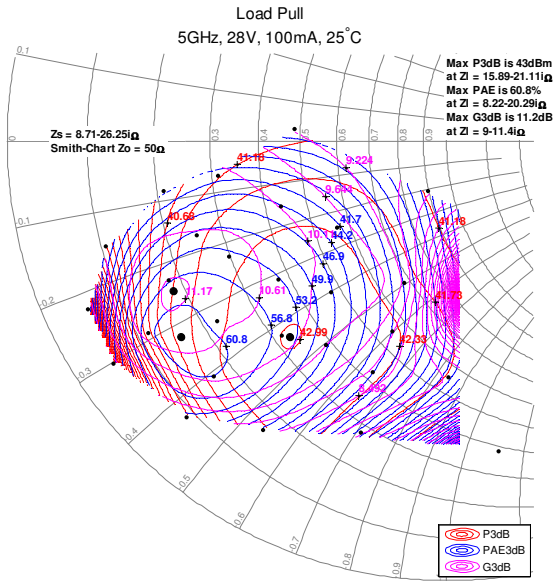

**Typical Performance<sup>(1,2,3)</sup>**

Notes:

1. Pulsed signal with 100uS pulse width and 20% duty cycle
2. See page 15 for load pull and source pull reference planes.
3. Performance is measured at device reference planes.

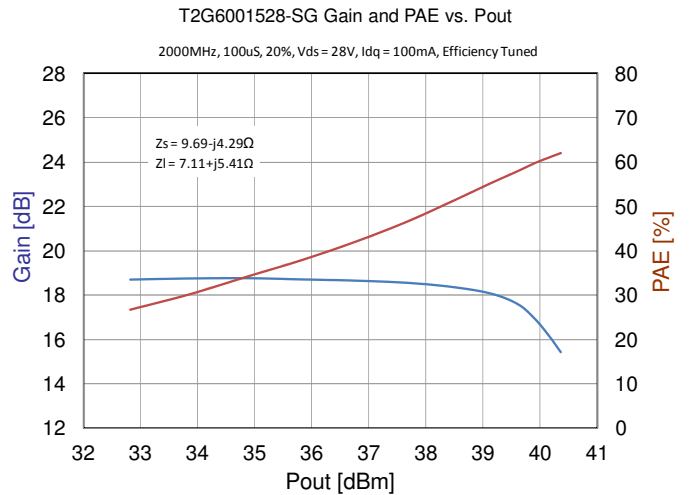
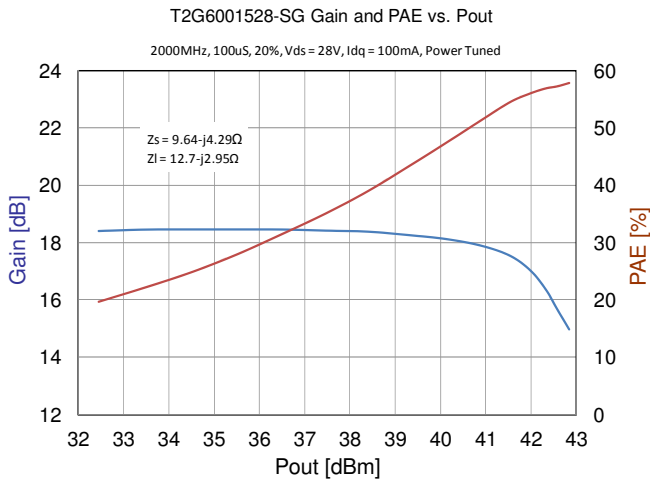
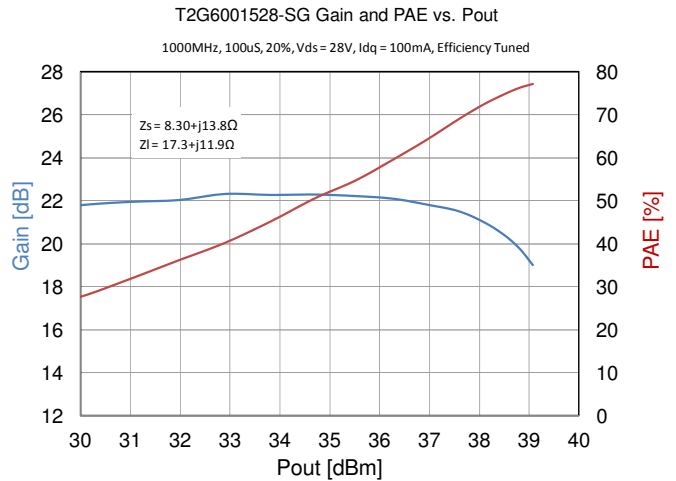
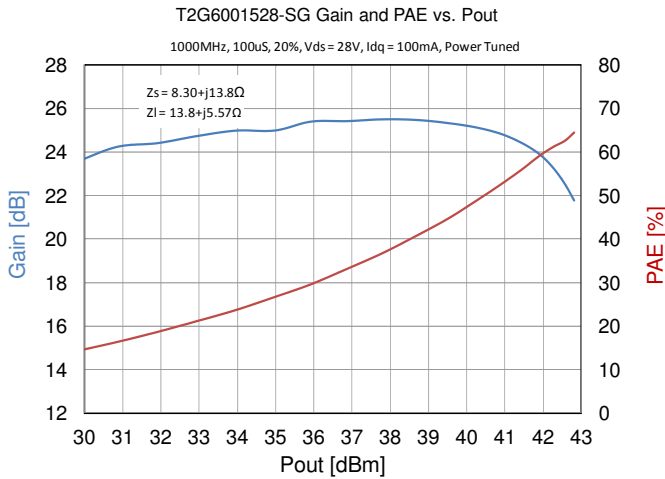



**Typical Performance<sup>(1,2,3)</sup>**

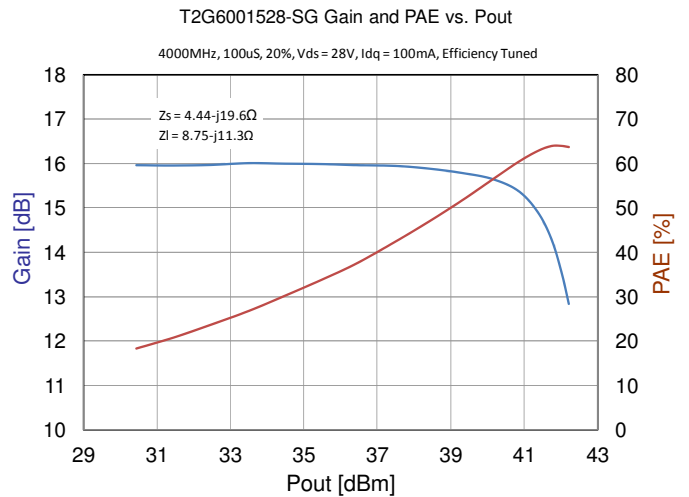
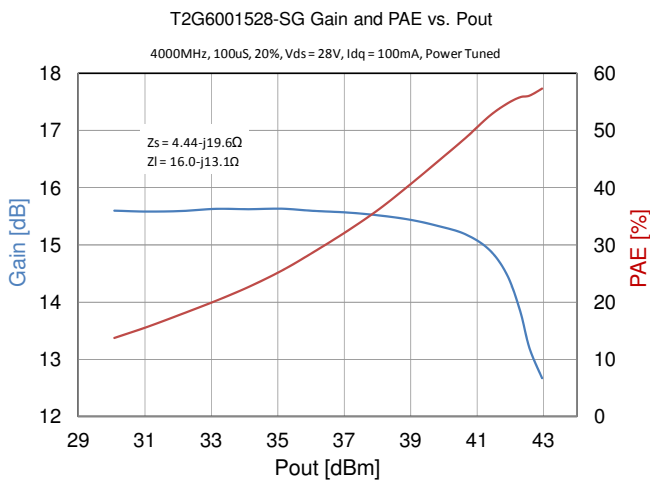
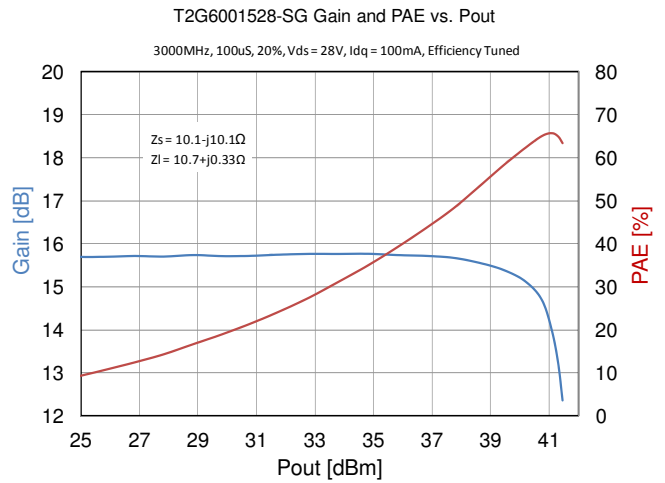
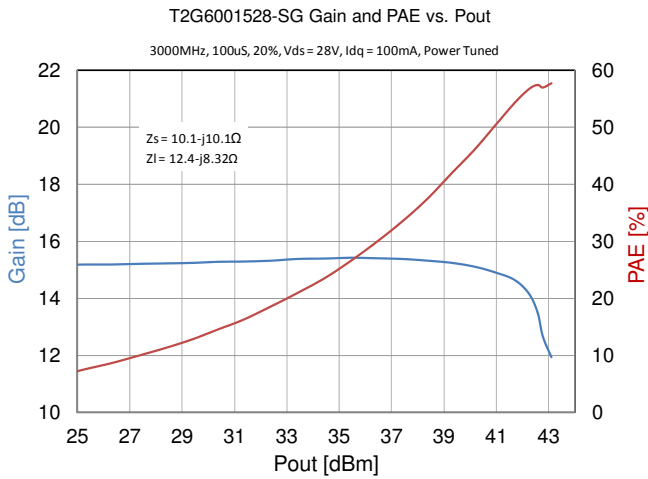

**Typical Performance<sup>(1,2,3)</sup>**

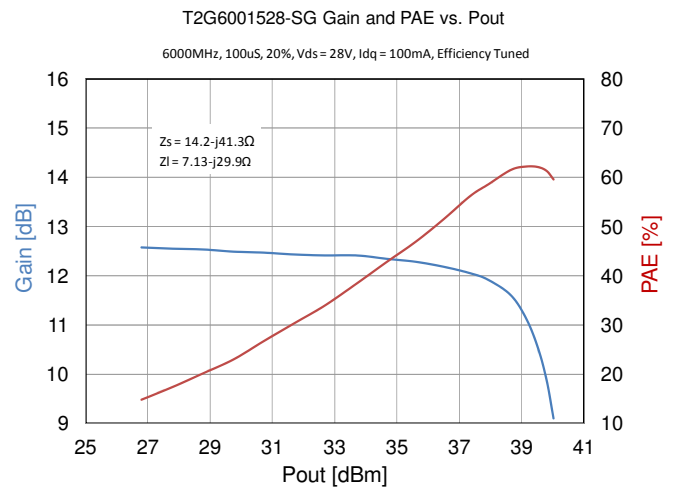
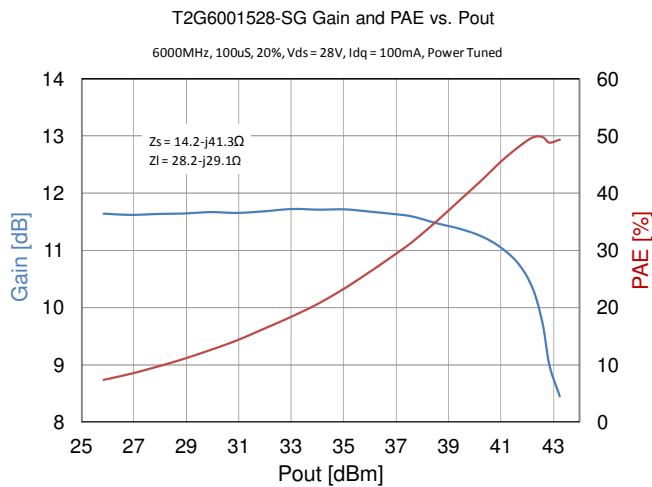
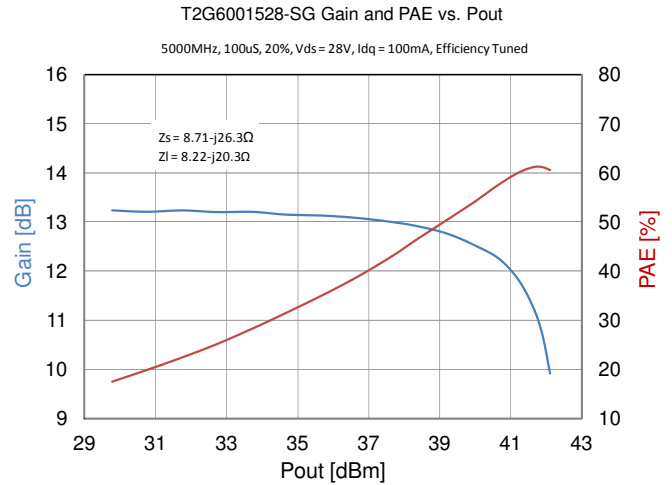
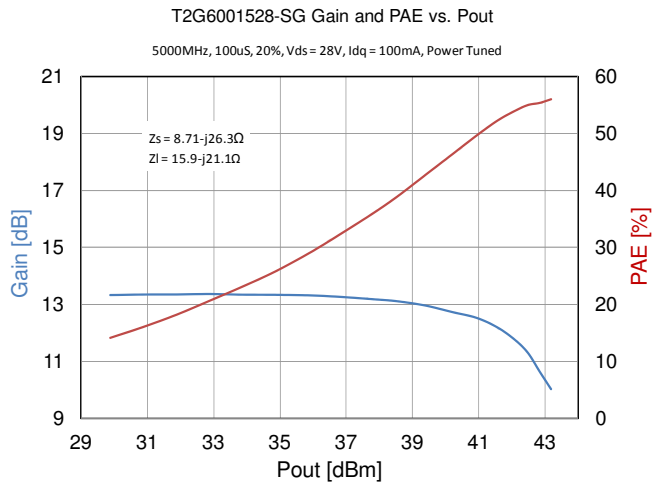

## Evaluation Board Performance Over Temperature <sup>(1, 2)</sup>

Performance measured on TriQuint's 3.1 GHz to 3.5 GHz Evaluation Board

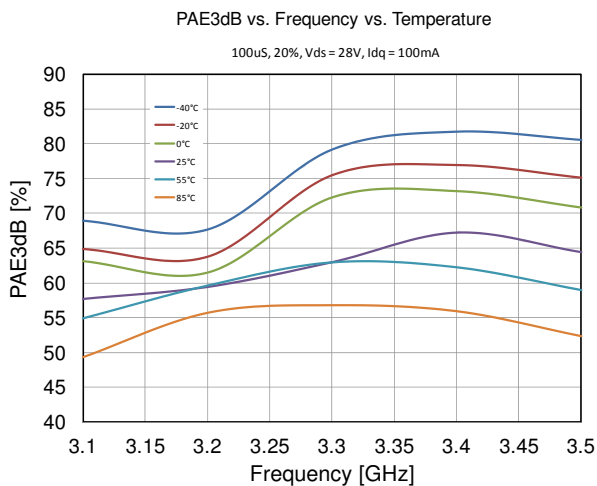
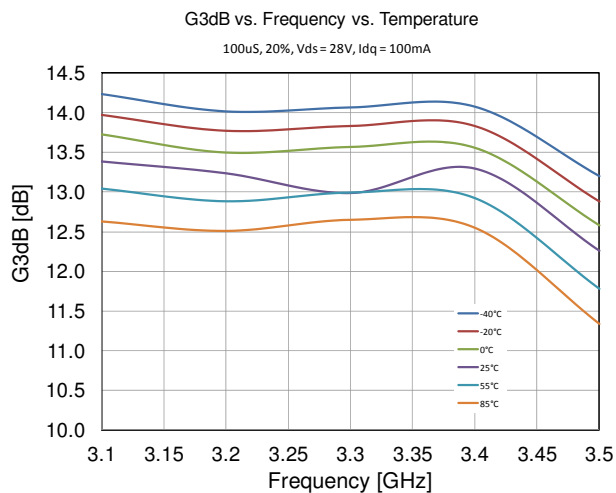
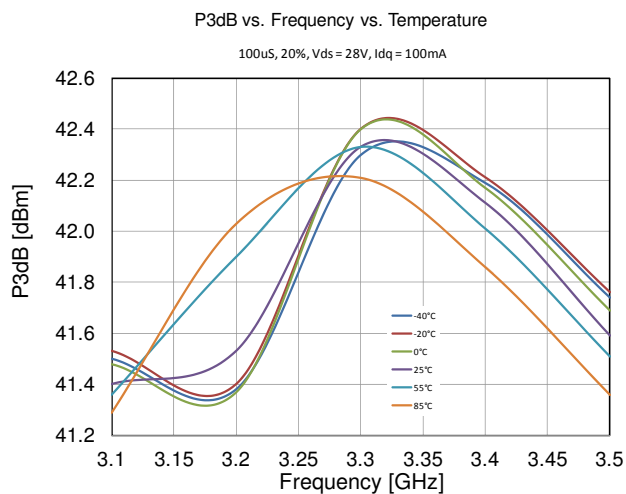

Notes:

1. Test Conditions:  $V_{DS} = 28\text{ V}$ ,  $I_{DQ} = 100\text{ mA}$
2. Test Signal: Pulse Width = 100  $\mu\text{s}$ , Duty Cycle = 20%

**Evaluation Board Performance At 25 °C<sup>(1, 2)</sup>**

Performance measured on TriQuint's 3.1 GHz to 3.5 GHz Evaluation Board

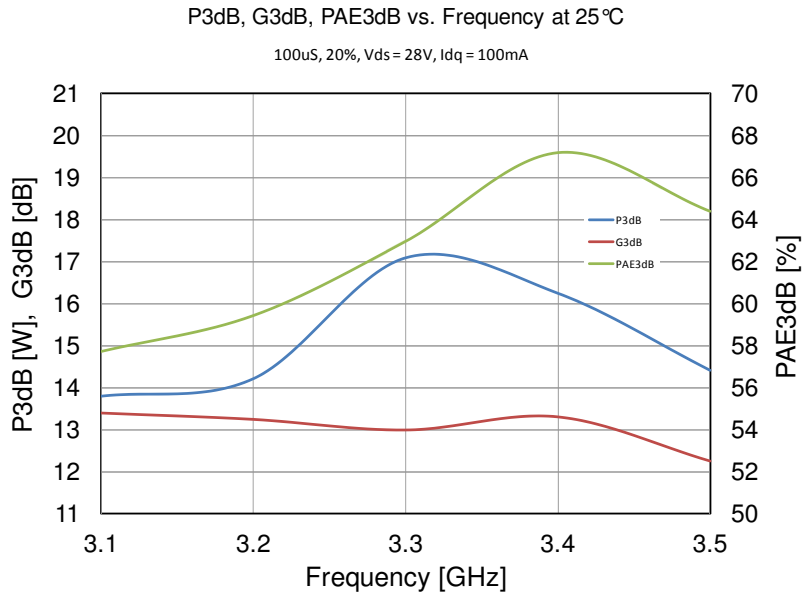

Notes:

1. Test Conditions:  $V_{DS} = 28\text{ V}$ ,  $I_{DQ} = 100\text{ mA}$ ,  $25\text{ °C}$
2. Test Signal: Pulse Width =  $100\text{ }\mu\text{s}$ , Duty Cycle = 20 %

**Application Circuit**

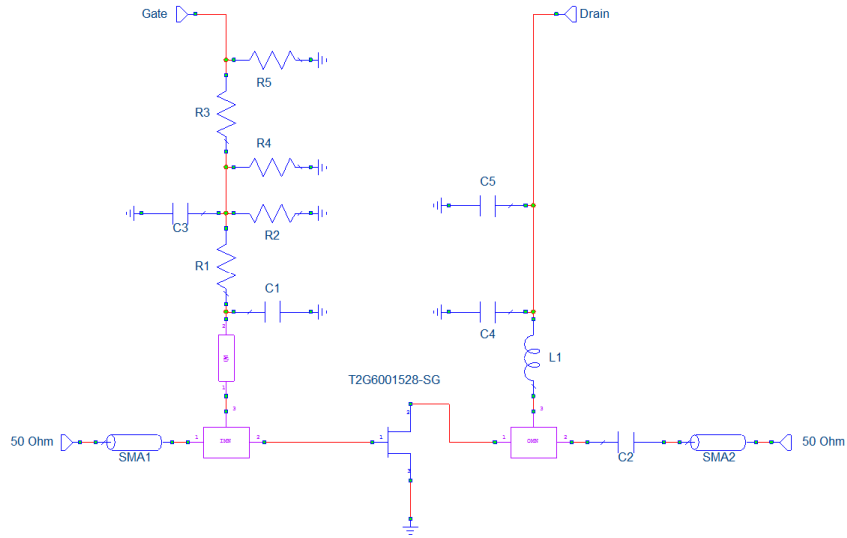

**Bias-up Procedure**

- Set gate voltage ( $V_G$ ) to -5.0V
- Set drain voltage ( $V_D$ ) to 28 V
- Slowly increase  $V_G$  until quiescent  $I_D$  is 100 mA.
- Apply RF signal

**Bias-down Procedure**

- Turn off RF signal
- Turn off  $V_D$  and wait 1 second to allow drain capacitor dissipation
- Turn off  $V_G$

## Evaluation Board Layout

Top RF layer is 0.020" thick Rogers RO4350B,  $\epsilon_r = 3.48$ . The pad pattern shown has been developed and tested for optimized assembly at TriQuint Semiconductor. The PCB land pattern has been developed to accommodate lead and package tolerances.

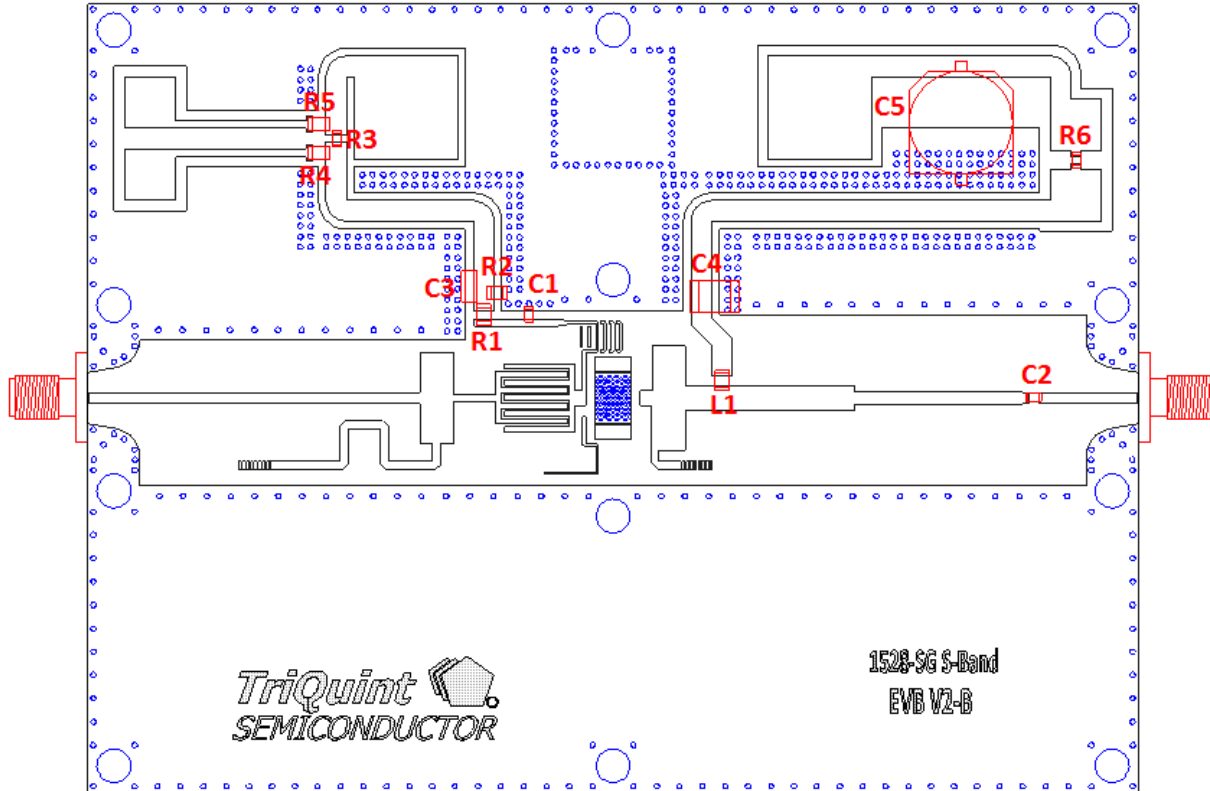

## Bill of Materials

Reference Design	Value	Qty	Manufacturer	Part Number
C1, C2	18 pF	2	ATC	600S1802BT250XT
C3	10 uF	1	TDK	C1632X5ROJ106M130AC
C4	1.0 uF	1	AVX	18121C105KAT2A
C5	220 uF	1	Nichicon	UWT1H221MNL1GS
R1, R3	10 $\Omega$	2	Panasonic	ERJ-3EKF10R0V
R2	1k $\Omega$	1	Panasonic	ERJ-6ENF1001V
R4, R5				Do Not Place
R6				Do Not Place
L1	22 nH	1	Coilcraft	0805CS-220X_L_

**Pin Layout**

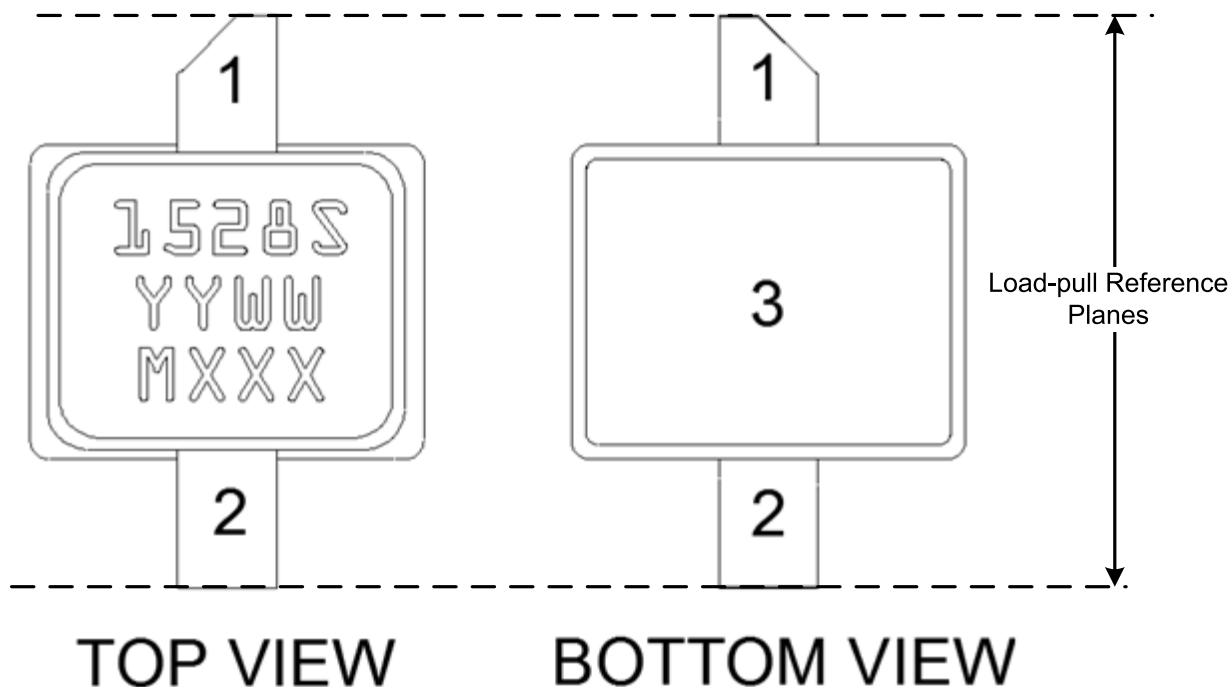

**Pin Description**

Pin	Symbol	Description
1	$V_D$ / RF OUT	Drain voltage / RF Output to be matched to 50 ohms; see EVB Layout on page 14 as an example.
2	$V_G$ / RF IN	Gate voltage / RF Input to be matched to 50 ohms; see EVB Layout on page 14 as an example.
3	Flange	Source connected to ground; see EVB Layout on page 14 as an example.

Notes:

Thermal resistance measured to back side of package

Note:

The T2G6001528-SG will be marked with the “1528S” designator and a lot code marked below the part designator. The “YY” represents the last two digits of the calendar year the part was manufactured, the “WW” is the work week of the assembly lot start, and the “MXXX” is the production lot number.

**Mechanical Information**

All dimensions are in inches.

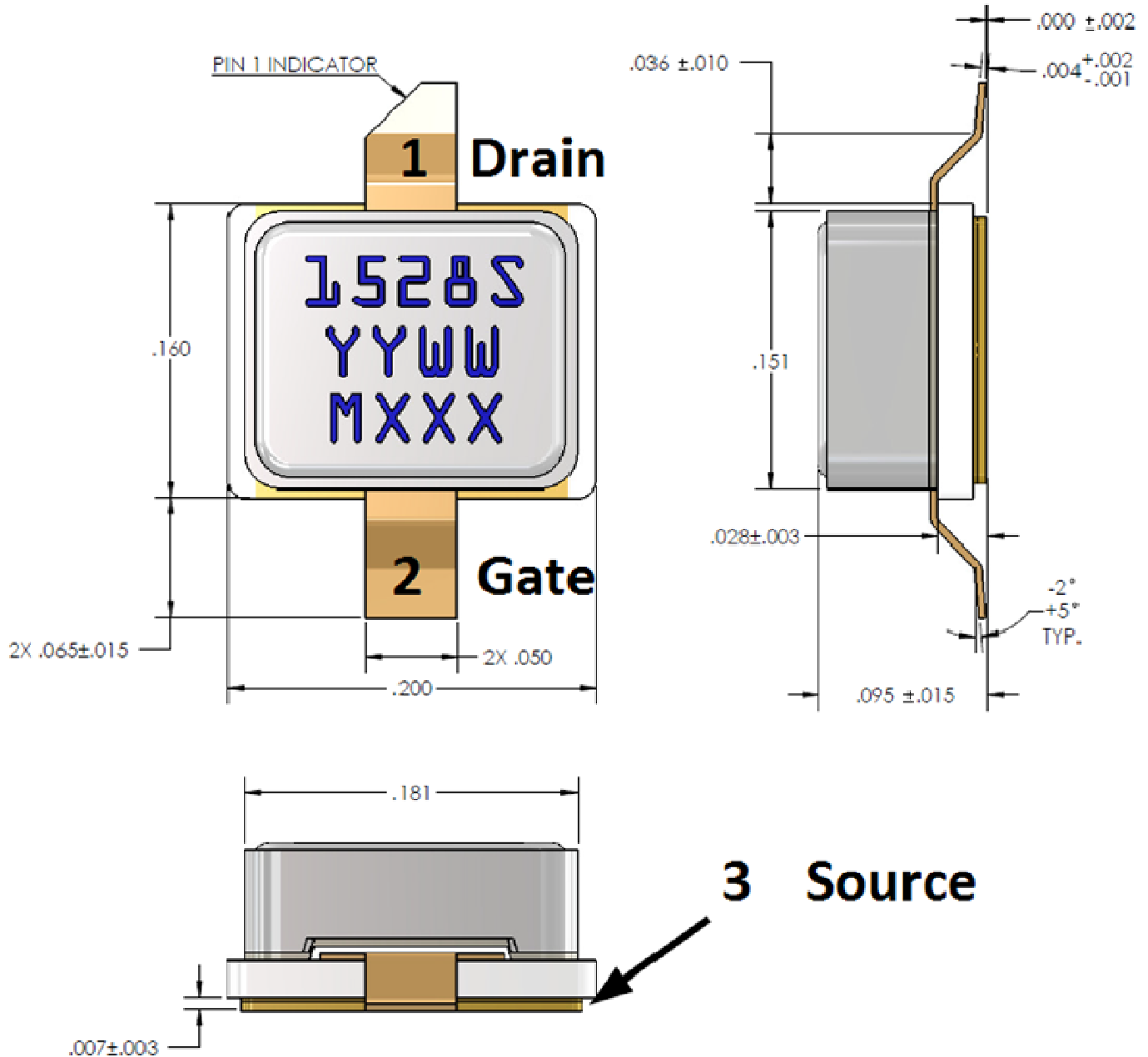

**Note:**

Unless otherwise noted, all dimension tolerances are +/-0.005.

This package is lead-free/RoHS-compliant. The plating material on the leads is NiAu. It is compatible with both lead-free (maximum 260 °C reflow temperature) and tin-lead (maximum 245 °C reflow temperature) soldering processes.



## Product Compliance Information

### ESD Sensitivity Ratings



Caution! ESD-Sensitive Device

ESD Rating: Class 1A  
 Value: Passes  $\geq 400$  V min.  
 Test: Human Body Model (HBM)  
 Standard: JEDEC Standard JESD22-A114

### MSL Rating

Level 3 at +260 °C convection reflow  
 The part is rated Moisture Sensitivity Level 3 at 260°C per JEDEC standard IPC/JEDEC J-STD-020.

### ECCN

US Department of Commerce EAR99

### Solderability

Compatible with the latest version of J-STD-020, Lead free solder, 260 °C

### RoHS Compliance

This part is compliant with EU 2002/95/EC RoHS directive (Restrictions on the Use of Certain Hazardous Substances in Electrical and Electronic Equipment).

This product also has the following attributes:

- Lead Free
- Halogen Free (Chlorine, Bromine)
- Antimony Free
- TBBP-A (C<sub>15</sub>H<sub>12</sub>Br<sub>4</sub>O<sub>2</sub>) Free
- PFOS Free
- SVHC Free

## Recommended Soldering Temperature Profile

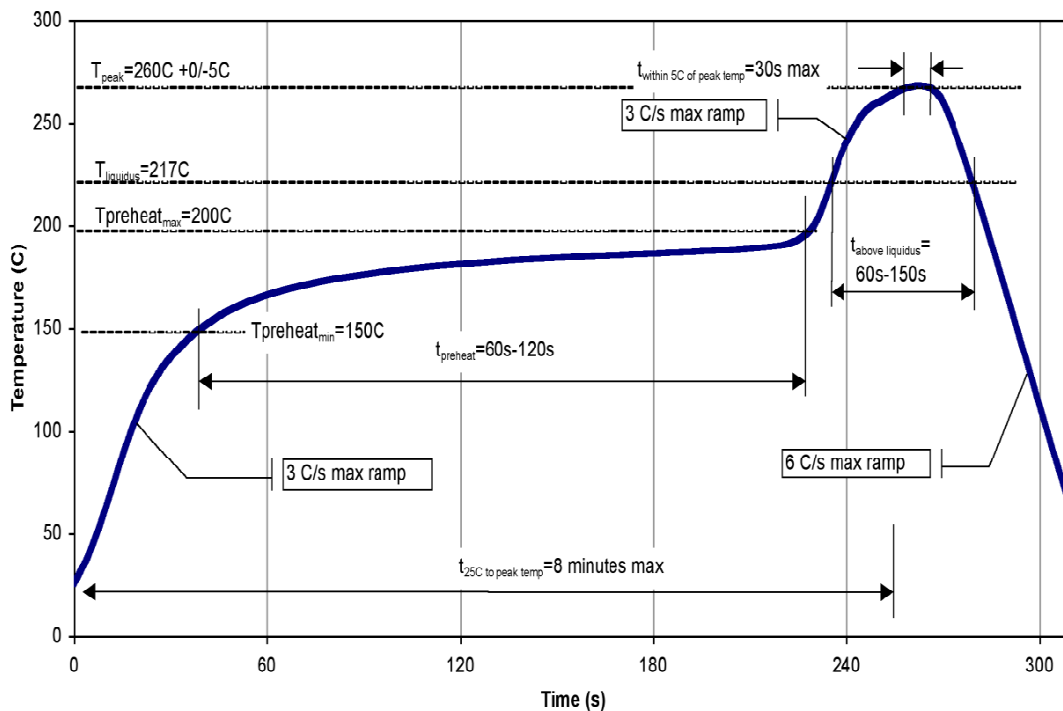

## Contact Information

For the latest specifications, additional product information, worldwide sales and distribution locations, and information about TriQuint:

**Web:** [www.triquint.com](http://www.triquint.com)

**Tel:** +1.972.994.8465

**Email:** [info-sales@triquint.com](mailto:info-sales@triquint.com)

**Fax:** +1.972.994.8504

For technical questions and application information:

**Email:** [info-products@triquint.com](mailto:info-products@triquint.com)

## Important Notice

The information contained herein is believed to be reliable. TriQuint makes no warranties regarding the information contained herein. TriQuint assumes no responsibility or liability whatsoever for any of the information contained herein. TriQuint assumes no responsibility or liability whatsoever for the use of the information contained herein. The information contained herein is provided "AS IS, WHERE IS" and with all faults, and the entire risk associated with such information is entirely with the user. All information contained herein is subject to change without notice. Customers should obtain and verify the latest relevant information before placing orders for TriQuint products. The information contained herein or any use of such information does not grant, explicitly or implicitly, to any party any patent rights, licenses, or any other intellectual property rights, whether with regard to such information itself or anything described by such information.

TriQuint products are not warranted or authorized for use as critical components in medical, life-saving, or life-sustaining applications, or other applications where a failure would reasonably be expected to cause severe personal injury or death.

Компания «Life Electronics» занимается поставками электронных компонентов импортного и отечественного производства от производителей и со складов крупных дистрибьюторов Европы, Америки и Азии.

С конца 2013 года компания активно расширяет линейку поставок компонентов по направлению коаксиальный кабель, кварцевые генераторы и конденсаторы (керамические, пленочные, электролитические), за счёт заключения дистрибьюторских договоров

Мы предлагаем:

- Конкурентоспособные цены и скидки постоянным клиентам.
- Специальные условия для постоянных клиентов.
- Подбор аналогов.
- Поставку компонентов в любых объемах, удовлетворяющих вашим потребностям.
- Приемлемые сроки поставки, возможна ускоренная поставка.
- Доставку товара в любую точку России и стран СНГ.
- Комплексную поставку.
- Работу по проектам и поставку образцов.
- Формирование склада под заказчика.
- Сертификаты соответствия на поставляемую продукцию (по желанию клиента).
- Тестирование поставляемой продукции.
- Поставку компонентов, требующих военную и космическую приемку.
- Входной контроль качества.
- Наличие сертификата ISO.

В составе нашей компании организован Конструкторский отдел, призванный помогать разработчикам, и инженерам.

Конструкторский отдел помогает осуществить:

- Регистрацию проекта у производителя компонентов.
- Техническую поддержку проекта.
- Защиту от снятия компонента с производства.
- Оценку стоимости проекта по компонентам.
- Изготовление тестовой платы монтаж и пусконаладочные работы.



Тел: +7 (812) 336 43 04 (многоканальный)  
Email: [org@lifeelectronics.ru](mailto:org@lifeelectronics.ru)