

FEATURES

Fixed gain of 22.2 dB
Broad operation from 30 MHz to 6 GHz
High dynamic range gain block
Input and output internally matched to 50 Ω
Integrated bias circuit
OIP3 of 40.0 dBm at 900 MHz
P1dB of 21.0 dBm at 900 MHz
Noise figure of 2.1 dB at 900 MHz
Single 5 V power supply
Low quiescent current of 94 mA
Wide operating temperature range of -40°C to $+105^{\circ}\text{C}$
Thermally efficient SOT-89 package
ESD rating of ± 1.5 kV (Class 1C)

GENERAL DESCRIPTION

The **ADL5611** is a single-ended RF/IF gain block amplifier that provides broadband operation from 30 MHz to 6 GHz. The **ADL5611** provides a low noise figure of 2.1 dB with a very high OIP3 of 40.0 dBm simultaneously, which delivers a high dynamic range.

The **ADL5611** provides a gain of 22.2 dB that is stable over frequency, temperature, and power supply, and from device to device. The amplifier is offered in the industry-standard SOT-89 package and is internally matched to 50 Ω at the input and output, making the **ADL5611** easy to implement in a wide variety of applications.

FUNCTIONAL BLOCK DIAGRAM

Figure 1.

The only external parts required are the input and output ac coupling capacitors, power supply decoupling capacitors, and bias inductor.

The **ADL5611** has a high ESD rating of ± 1.5 kV (Class 1C) and is fully specified for operation across a wide temperature range of -40°C to $+105^{\circ}\text{C}$.

A fully populated RoHS compliant evaluation board is available.

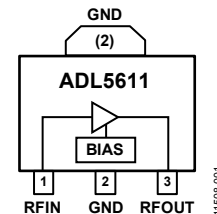
TABLE OF CONTENTS

Features	1	30 MHz to 500 MHz Frequency Band.....	10
Functional Block Diagram	1	General.....	11
General Description	1	Applications Information	13
Revision History	2	Basic Connections	13
Specifications.....	3	Soldering Information and Recommended PCB Land Pattern	14
Typical Scattering Parameters (S-Parameters)	5	W-CDMA ACPR Performance	14
Absolute Maximum Ratings.....	7	Evaluation Board	15
Thermal Resistance	7	Outline Dimensions	16
ESD Caution.....	7	Ordering Guide	16
Pin Configuration and Function Descriptions.....	8		
Typical Performance Characteristics	9		
500 MHz to 6 GHz Frequency Band.....	9		

REVISION HISTORY

12/15—Rev. A to Rev. B

Updated Outline Dimensions	16
----------------------------------	----

9/13—Rev. 0 to Rev. A

Added Figure 19; Renumbered Sequentially	11
Changes to Figure 29.....	14
Updated Outline Dimensions	16

7/13—Revision 0: Initial Version

SPECIFICATIONS

$V_{POS} = 5\text{ V}$ and $T_A = 25^\circ\text{C}$, unless otherwise noted.

Table 1.

Parameter	Test Conditions/Comments	Min	Typ	Max	Unit
OVERALL FUNCTION					
Frequency Range		30		6000	MHz
FREQUENCY = 30 MHz					
Gain			21.8		dB
Output 1 dB Compression Point (P1dB)			16.0		dBm
Output Third-Order Intercept (OIP3)	$\Delta f = 1\text{ MHz}$, output power (P_{OUT}) = 0 dBm per tone		27.6		dBm
Noise Figure ¹			3.9		dB
FREQUENCY = 140 MHz					
Gain			18.9		dB
vs. Frequency	$\pm 10\text{ MHz}$		± 0.42		dB
vs. Temperature	$-40^\circ\text{C} \leq T_A \leq +105^\circ\text{C}$		± 0.45		dB
vs. Supply	4.75 V to 5.25 V		± 0.09		dB
Output 1 dB Compression Point			16.3		dBm
Output Third-Order Intercept	$\Delta f = 1\text{ MHz}$, $P_{OUT} = 0\text{ dBm}$ per tone		27.2		dBm
Noise Figure ¹			3.3		dB
FREQUENCY = 350 MHz					
Gain			22.0		dB
vs. Frequency	$\pm 10\text{ MHz}$		± 0.04		dB
vs. Temperature	$-40^\circ\text{C} \leq T_A \leq +105^\circ\text{C}$		± 0.28		dB
vs. Supply	4.75 V to 5.25 V		± 0.06		dB
Output 1 dB Compression Point			20.9		dBm
Output Third-Order Intercept	$\Delta f = 1\text{ MHz}$, $P_{OUT} = 0\text{ dBm}$ per tone		34.0		dBm
Noise Figure ¹			2.4		dB
FREQUENCY = 700 MHz					
Gain			22.2		dB
vs. Frequency	$\pm 50\text{ MHz}$		± 0.02		dB
vs. Temperature	$-40^\circ\text{C} \leq T_A \leq +105^\circ\text{C}$		± 0.26		dB
vs. Supply	4.75 V to 5.25 V		± 0.08		dB
Output 1 dB Compression Point			21.0		dBm
Output Third-Order Intercept	$\Delta f = 1\text{ MHz}$, $P_{OUT} = 0\text{ dBm}$ per tone		39.6		dBm
Noise Figure ¹			2.1		dB
FREQUENCY = 900 MHz					
Gain		21.2	22.2	23.2	dB
vs. Frequency	$\pm 50\text{ MHz}$		± 0.02		dB
vs. Temperature	$-40^\circ\text{C} \leq T_A \leq +105^\circ\text{C}$		± 0.25		dB
vs. Supply	4.75 V to 5.25 V		± 0.10		dB
Output 1 dB Compression Point			21.0		dBm
Output Third-Order Intercept	$\Delta f = 1\text{ MHz}$, $P_{OUT} = 0\text{ dBm}$ per tone		40.0		dBm
Noise Figure ¹			2.1		dB
FREQUENCY = 1900 MHz					
Gain		20.4	21.4	22.4	dB
vs. Frequency	$\pm 50\text{ MHz}$		± 0.07		dB
vs. Temperature	$-40^\circ\text{C} \leq T_A \leq +105^\circ\text{C}$		± 0.34		dB
vs. Supply	4.75 V to 5.25 V		± 0.20		dB
Output 1 dB Compression Point			20.6		dBm
Output Third-Order Intercept	$\Delta f = 1\text{ MHz}$, $P_{OUT} = 0\text{ dBm}$ per tone		37.0		dBm
Noise Figure ¹			2.4		dB

Parameter	Test Conditions/Comments	Min	Typ	Max	Unit
FREQUENCY = 2140 MHz					
Gain			21.2		dB
vs. Frequency	±50 MHz		±0.05		dB
vs. Temperature	−40°C ≤ T _A ≤ +105°C		±0.38		dB
vs. Supply	4.75 V to 5.25 V		±0.23		dB
Output 1 dB Compression Point			20.6		dBm
Output Third-Order Intercept	Δf = 1 MHz, P _{OUT} = 0 dBm per tone		35.8		dBm
Noise Figure ¹			2.6		dB
FREQUENCY = 2600 MHz					
Gain			20.7		dB
vs. Frequency	±50 MHz		±0.06		dB
vs. Temperature	−40°C ≤ T _A ≤ +105°C		±0.55		dB
vs. Supply	4.75 V to 5.25 V		±0.25		dB
Output 1 dB Compression Point			19.4		dBm
Output Third-Order Intercept	Δf = 1 MHz, P _{OUT} = 0 dBm per tone		32.3		dBm
Noise Figure ¹			2.8		dB
FREQUENCY = 3500 MHz					
Gain			20.3		dB
vs. Frequency	±50 MHz		±0.03		dB
vs. Temperature	−40°C ≤ T _A ≤ +105°C		±1.05		dB
vs. Supply	4.75 V to 5.25 V		±0.26		dB
Output 1 dB Compression Point			17.4		dBm
Output Third-Order Intercept	Δf = 1 MHz, P _{OUT} = 0 dBm per tone		28.6		dBm
Noise Figure ¹			3.1		dB
FREQUENCY = 4000 MHz					
Gain			20.0		dB
vs. Frequency	±50 MHz		±0.13		dB
vs. Temperature	−40°C ≤ T _A ≤ +105°C		±1.55		dB
vs. Supply	4.75 V to 5.25 V		±0.27		dB
Output 1 dB Compression Point			16.2		dBm
Output Third-Order Intercept	Δf = 1 MHz, P _{OUT} = 0 dBm per tone		27.4		dBm
Noise Figure ¹			3.2		dB
FREQUENCY = 5000 MHz					
Gain			16.3		dB
vs. Frequency	±50 MHz		±0.16		dB
vs. Temperature	−40°C ≤ T _A ≤ +105°C		±1.49		dB
vs. Supply	4.75 V to 5.25 V		±0.28		dB
Output 1 dB Compression Point			16.0		dBm
Output Third-Order Intercept	Δf = 1 MHz, P _{OUT} = 0 dBm per tone		27.0		dBm
Noise Figure ¹			4.4		dB
FREQUENCY = 5800 MHz					
Gain			14.3		dB
vs. Frequency	±50 MHz		±0.11		dB
vs. Temperature	−40°C ≤ T _A ≤ +105°C		±1.67		dB
vs. Supply	4.75 V to 5.25 V		±0.23		dB
Output 1 dB Compression Point			12.8		dBm
Output Third-Order Intercept	Δf = 1 MHz, P _{OUT} = 0 dBm per tone		23.0		dBm
Noise Figure ¹			6.0		dB

Parameter	Test Conditions/Comments	Min	Typ	Max	Unit
POWER INTERFACE					
Supply Voltage	V_{POS}	4.75	5	5.25	V
Supply Current			94	124	mA
vs. Temperature	$-40^{\circ}\text{C} \leq T_A \leq +105^{\circ}\text{C}$		-7/+14		mA
Power Dissipation	$V_{POS} = 5\text{ V}$		470		mW

¹ Noise figure specified includes printed circuit board (PCB) traces losses.

TYPICAL SCATTERING PARAMETERS (S-PARAMETERS)

$V_{POS} = 5\text{ V}$ and $T_A = 25^{\circ}\text{C}$.

Table 2.

Frequency (MHz)	S11		S21		S12		S22	
	Magnitude (dB)	Angle (°)	Magnitude (dB)	Angle (°)	Magnitude (dB)	Angle (°)	Magnitude (dB)	Angle (°)
30	-19.413	-26.158	+21.776	+172.769	-27.133	+0.556	-11.297	-165.214
50	-13.165	+18.866	+20.450	+161.606	-28.149	-13.136	-7.839	-163.448
100	-7.702	-16.728	+17.424	+169.845	-31.453	-6.433	-5.303	-189.380
200	-10.283	-70.711	+20.615	+170.893	-28.530	-3.592	-7.558	-220.163
300	-13.623	-97.401	+21.750	+153.718	-27.648	-17.328	-9.628	-229.758
400	-16.531	-116.624	+22.133	+137.323	-27.393	-29.469	-10.723	-234.863
500	-13.489	-133.038	+21.878	-227.398	-27.654	-30.240	-9.139	-242.984
600	-15.012	-155.101	+22.109	-242.602	-27.407	-41.040	-9.456	-252.814
700	-16.953	-173.278	+22.166	-258.309	-27.340	-52.626	-9.852	-259.624
800	-18.750	-191.016	+22.175	-273.359	-27.310	-63.591	-10.087	-266.406
900	-20.402	-209.005	+22.157	-287.987	-27.272	-74.251	-10.220	-273.138
1000	-22.020	-226.338	+22.123	-302.271	-27.262	-84.772	-10.281	-280.106
1100	-23.568	-243.133	+22.077	-316.366	-27.273	-94.790	-10.316	-286.874
1200	-25.331	-258.964	+22.018	-330.209	-27.269	-104.782	-10.341	-293.925
1300	-27.267	-272.170	+21.957	-343.987	-27.264	-114.842	-10.329	-300.962
1400	-29.729	-280.677	+21.882	-357.634	-27.273	-124.700	-10.350	-308.089
1500	-33.265	-281.069	+21.812	-371.163	-27.273	-134.354	-10.363	-314.919
1600	-35.854	-260.621	+21.737	-384.666	-27.266	-144.166	-10.357	-321.662
1700	-34.321	-226.683	+21.648	-398.040	-27.267	-154.033	-10.400	-328.324
1800	-29.745	-218.694	+21.569	-411.423	-27.245	-163.652	-10.392	-334.645
1900	-26.887	-221.152	+21.438	-424.771	-27.233	-173.766	-10.531	-341.717
2000	-24.113	-228.131	+21.331	-438.049	-27.225	-183.324	-10.566	-347.988
2100	-21.301	-235.040	+21.256	-451.001	-27.272	-193.034	-10.674	-352.991
2200	-19.164	-245.484	+21.164	-464.099	-27.274	-202.461	-10.724	-358.726
2300	-17.568	-257.372	+21.078	-477.290	-27.248	-212.036	-10.708	-364.342
2400	-16.338	-268.596	+20.965	-490.408	-27.207	-221.732	-10.706	-370.531
2500	-15.187	-279.362	+20.863	-503.418	-27.219	-231.237	-10.737	-376.605
2600	-14.370	-290.528	+20.734	-516.421	-27.195	-240.889	-10.755	-383.283
2700	-13.733	-301.461	+20.606	-529.269	-27.127	-250.483	-10.775	-390.170
2800	-13.062	-311.936	+20.519	-541.969	-27.084	-259.695	-10.809	-397.037
2900	-12.653	-322.355	+20.435	-554.516	-26.970	-269.348	-10.888	-404.594
3000	-12.418	-332.177	+20.380	-567.048	-26.772	-279.469	-11.086	-412.962
3100	-12.019	-342.619	+20.411	-579.843	-26.724	-289.424	-11.163	-420.818
3200	-11.809	-354.255	+20.422	-592.914	-26.607	-299.778	-11.348	-430.470
3300	-11.972	-366.792	+20.411	-606.400	-26.511	-309.746	-11.533	-440.976
3400	-12.388	-377.671	+20.419	-619.528	-26.359	-320.482	-12.017	-452.391
3500	-12.849	-390.154	+20.412	-633.251	-26.200	-331.064	-12.489	-465.304

Frequency (MHz)	S11		S21		S12		S22	
	Magnitude (dB)	Angle (°)	Magnitude (dB)	Angle (°)	Magnitude (dB)	Angle (°)	Magnitude (dB)	Angle (°)
3600	-13.681	-403.841	+20.385	-647.042	-26.068	-341.857	-13.141	-480.219
3700	-14.819	-418.280	+20.334	-661.029	-25.962	-352.974	-13.812	-497.201
3800	-16.480	-433.535	+20.321	-675.145	-25.829	-364.326	-14.683	-517.273
3900	-18.415	-450.193	+20.283	-689.975	-25.641	-375.829	-15.473	-540.432
4000	-20.901	-481.302	+20.107	-704.970	-25.735	-388.338	-15.539	-563.571
4100	-22.899	-530.706	+19.930	-719.959	-25.751	-400.117	-15.329	-589.891
4200	-20.175	-574.613	+19.528	-735.700	-25.987	-412.869	-14.226	-611.397
4300	-16.107	-607.497	+18.987	-750.647	-26.349	-424.046	-12.606	-631.788
4400	-12.487	-632.642	+18.248	-764.216	-26.734	-433.978	-10.710	-651.154
4500	-9.908	-655.826	+17.627	-775.099	-26.846	-442.104	-9.069	-671.887
4600	-8.294	-676.352	+17.415	-785.594	-26.704	-451.707	-7.925	-691.567
4700	-7.462	-692.336	+17.300	-797.596	-26.413	-463.172	-7.360	-709.087
4800	-6.742	-707.212	+17.180	-810.719	-26.495	-473.259	-6.944	-725.426
4900	-6.341	-719.044	+16.938	-823.703	-26.376	-485.497	-6.709	-738.970
5000	-5.850	-730.317	+16.723	-836.856	-26.732	-496.442	-6.431	-752.403
5100	-5.683	-740.078	+16.407	-849.613	-26.564	-506.443	-6.520	-764.449
5200	-5.393	-749.333	+16.142	-862.399	-26.637	-518.454	-6.474	-775.847
5300	-5.255	-757.862	+15.797	-874.886	-26.764	-527.731	-6.577	-787.719
5400	-4.941	-766.095	+15.601	-886.816	-26.723	-538.802	-6.816	-798.987
5500	-4.762	-775.169	+15.423	-899.572	-26.813	-550.352	-7.136	-810.139
5600	-4.751	-783.296	+15.212	-912.138	-26.836	-560.482	-7.707	-821.411
5700	-4.718	-791.495	+15.016	-925.031	-26.865	-570.790	-8.420	-832.448
5800	-4.803	-798.324	+14.811	-937.622	-26.711	-581.237	-9.417	-843.000
5900	-4.815	-805.589	+14.640	-950.405	-26.625	-592.240	-10.700	-853.572
6000	-4.846	-812.180	+14.474	-963.642	-26.496	-603.172	-12.335	-863.102

ABSOLUTE MAXIMUM RATINGS

Table 3.

Parameter	Rating
Supply Voltage, V_{POS}	6.5 V
Input Power (50 Ω Impedance)	20 dBm
Internal Power Dissipation (Pad Soldered to Ground)	800 mW
ESD Human Body Model (HBM) Rating (ESDA/ JEDEC JS-001-2011)	± 1.5 kV
Maximum Junction Temperature	150°C
Operating Temperature Range	-40°C to +105°C
Storage Temperature Range	-65°C to +150°C

Stresses at or above those listed under Absolute Maximum Ratings may cause permanent damage to the product. This is a stress rating only; functional operation of the product at these or any other conditions above those indicated in the operational section of this specification is not implied. Operation beyond the maximum operating conditions for extended periods may affect product reliability.

THERMAL RESISTANCE

Table 4 lists the junction-to-air thermal resistance (θ_{JA}) and the junction-to-case thermal resistance (θ_{JC}) for the ADL5611.

Table 4. Thermal Resistance

Package Type	θ_{JA} ¹	θ_{JC} ²	Unit
3-Lead SOT-89 (RK-3)	52	9	°C/W

¹ Measured on the ADL5611 evaluation board. For more information about board layout, see the Soldering Information and Recommended PCB Land Pattern section.

² Based on simulation with a standard JEDEC board per JESD51.

ESD CAUTION



ESD (electrostatic discharge) sensitive device. Charged devices and circuit boards can discharge without detection. Although this product features patented or proprietary protection circuitry, damage may occur on devices subjected to high energy ESD. Therefore, proper ESD precautions should be taken to avoid performance degradation or loss of functionality.

PIN CONFIGURATION AND FUNCTION DESCRIPTIONS

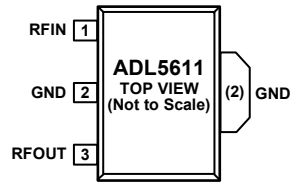

NOTES
 1. THE EXPOSED PAD ENCOMPASSES PIN 2 AND THE TAB AT THE TOP SIDE OF THE PACKAGE. SOLDER THE EXPOSED PAD TO A LOW IMPEDANCE GROUND PLANE FOR ELECTRICAL GROUNDING AND THERMAL TRANSFER.

11-6048-002

Figure 2. Pin Configuration

Table 5. Pin Function Descriptions

Pin No.	Mnemonic	Description
1	RFIN	RF Input. This pin requires a dc blocking capacitor.
2	GND	Ground. Connect this pin to a low impedance ground plane.
3	RFOUT	RF Output and Supply Voltage. DC bias is provided to this pin through an inductor that is connected to the external power supply. The RF path requires a dc blocking capacitor.
	EPAD	Exposed Pad. The exposed pad encompasses Pin 2 and the tab at the top side of the package. Solder the exposed pad to a low impedance ground plane for electrical grounding and thermal transfer.

TYPICAL PERFORMANCE CHARACTERISTICS

500 MHz TO 6 GHz FREQUENCY BAND

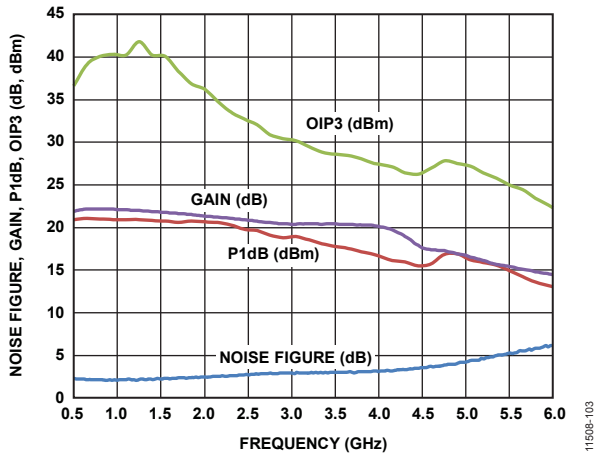

Figure 3. Noise Figure, Gain, P1dB, and OIP3 vs. Frequency

11508-103

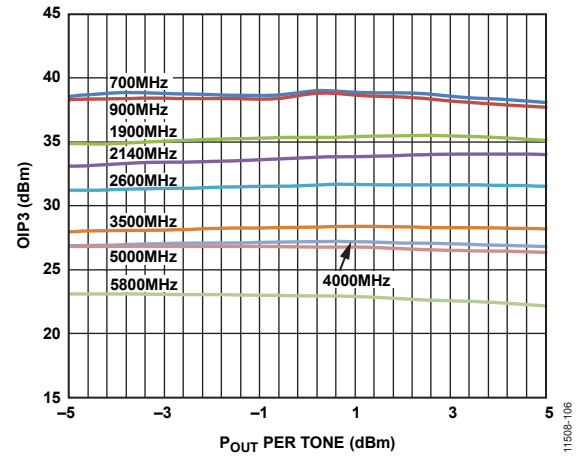

Figure 6. OIP3 vs. Output Power (P_{out}) and Frequency

11508-106

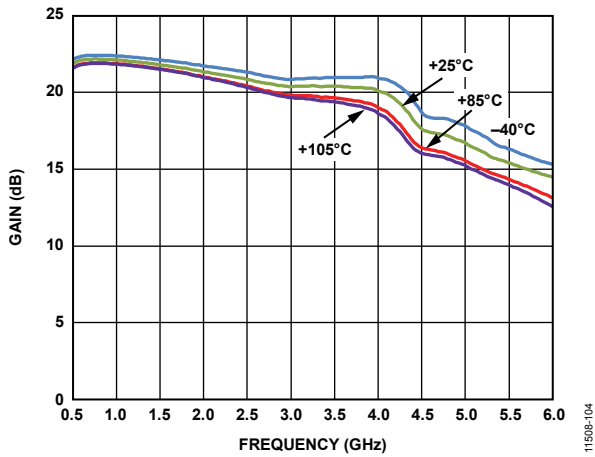

Figure 4. Gain vs. Frequency and Temperature

11508-104

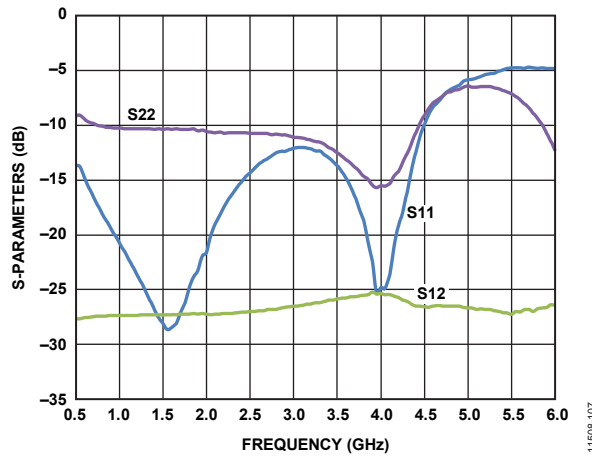

Figure 7. Output Return Loss (S_{22}), Input Return Loss (S_{11}), and Reverse Isolation (S_{12}) vs. Frequency

11508-107

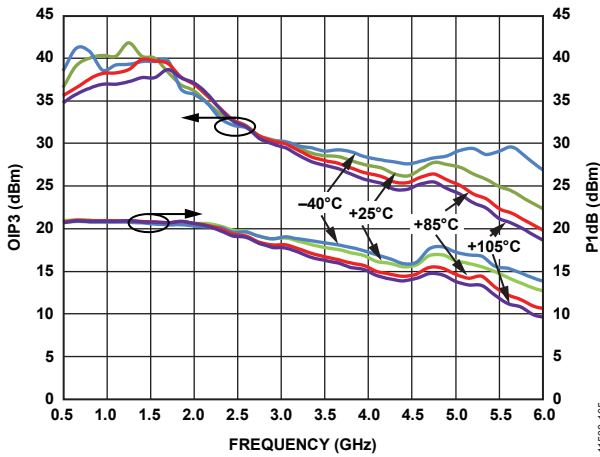

Figure 5. OIP3 and P1dB vs. Frequency and Temperature

11508-105

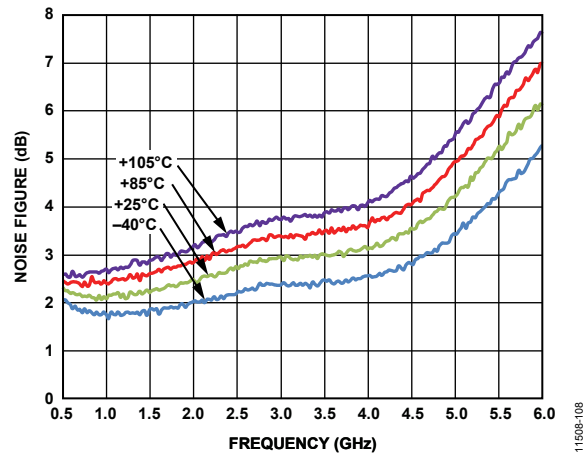

Figure 8. Noise Figure vs. Frequency and Temperature

11508-108

30 MHz TO 500 MHz FREQUENCY BAND

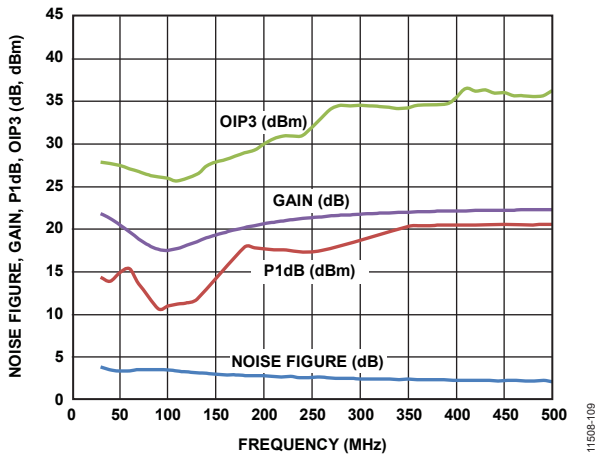

Figure 9. Noise Figure, Gain, P1dB, and OIP3 vs. Frequency, Low Frequency Configuration

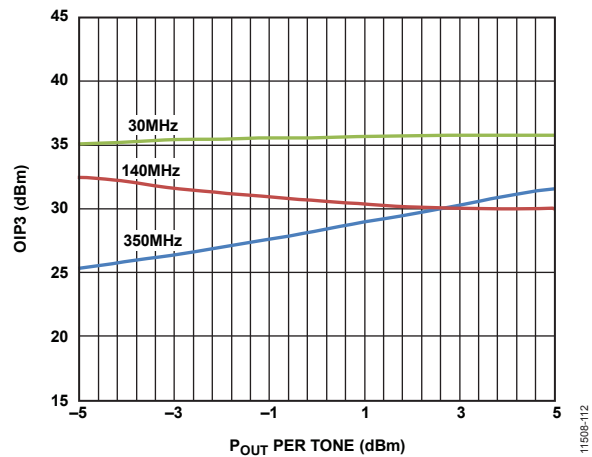

Figure 12. OIP3 vs. Output Power (P_{out}) and Frequency, Low Frequency Configuration

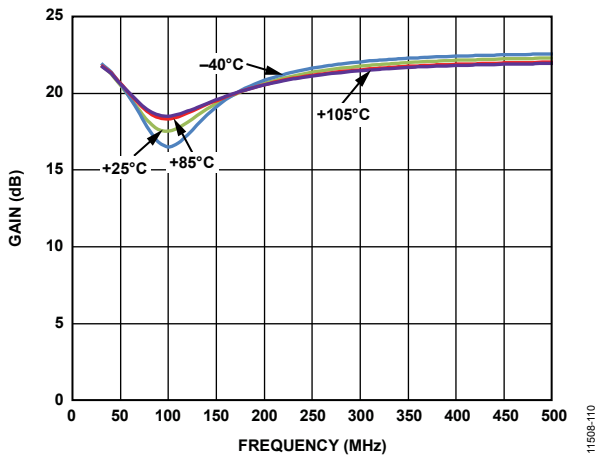

Figure 10. Gain vs. Frequency and Temperature, Low Frequency Configuration

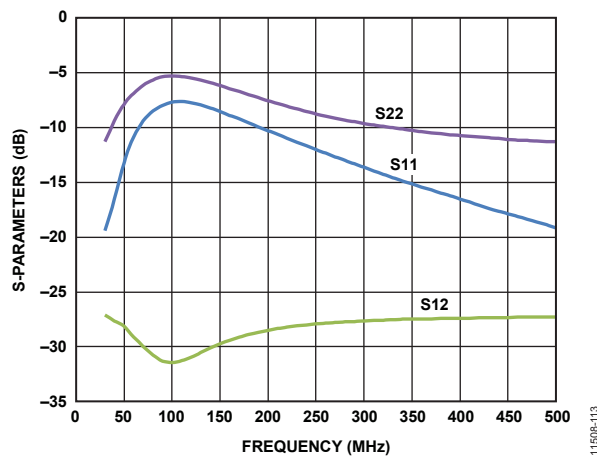

Figure 13. Output Return Loss (S_{22}), Input Return Loss (S_{11}), and Reverse Isolation (S_{12}) vs. Frequency, Low Frequency Configuration

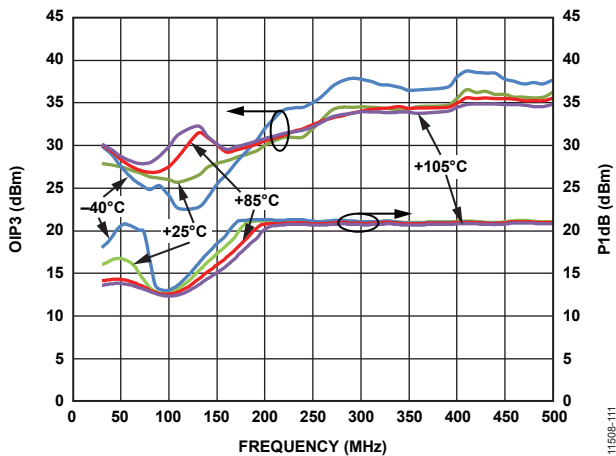

Figure 11. OIP3 and P1dB vs. Frequency and Temperature, Low Frequency Configuration

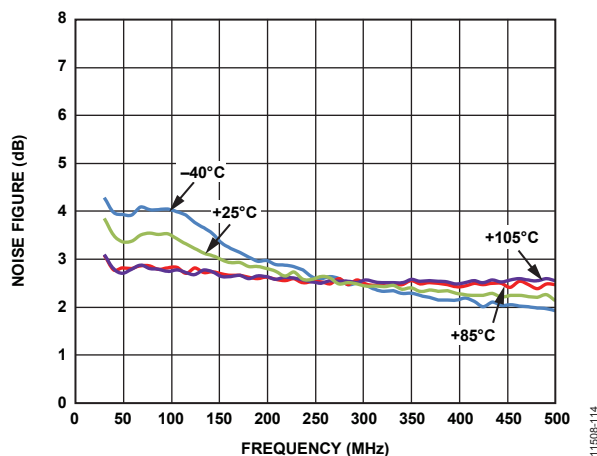

Figure 14. Noise Figure vs. Frequency and Temperature, Low Frequency Configuration

GENERAL

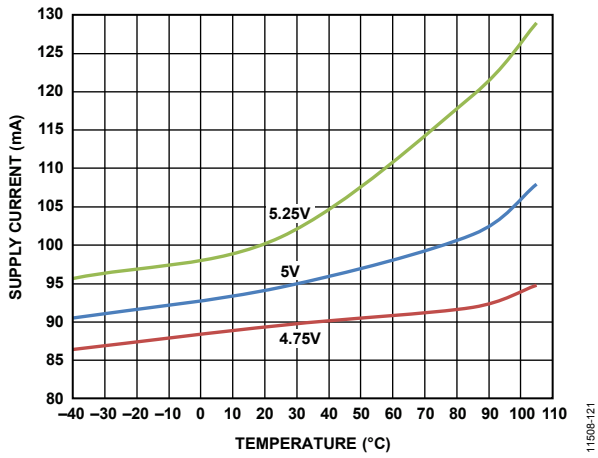

Figure 15. Supply Current vs. Temperature

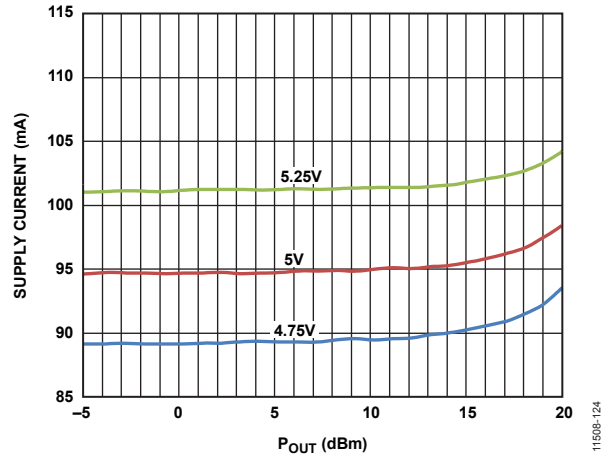

Figure 18. Supply Current vs. P_{OUT} at 900 MHz

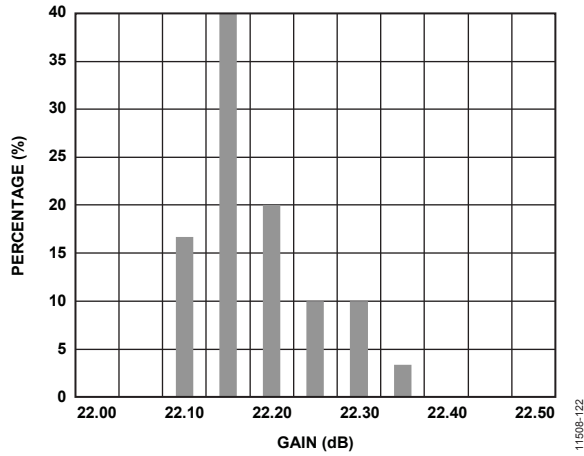

Figure 16. Gain Distribution at 900 MHz

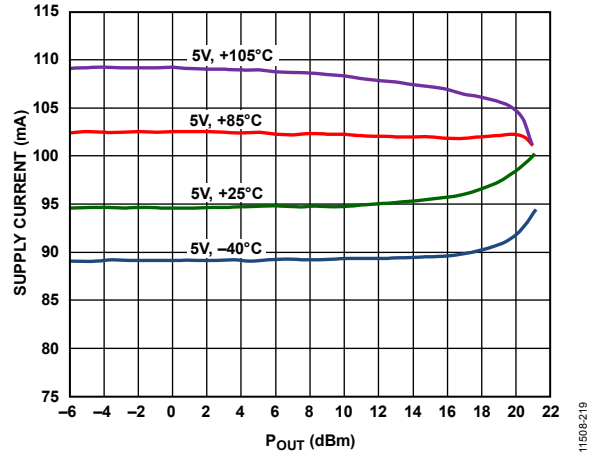

Figure 19. Supply Current vs. P_{OUT} for Various Temperatures, $V_{CC} = 5 V$ at 900 MHz

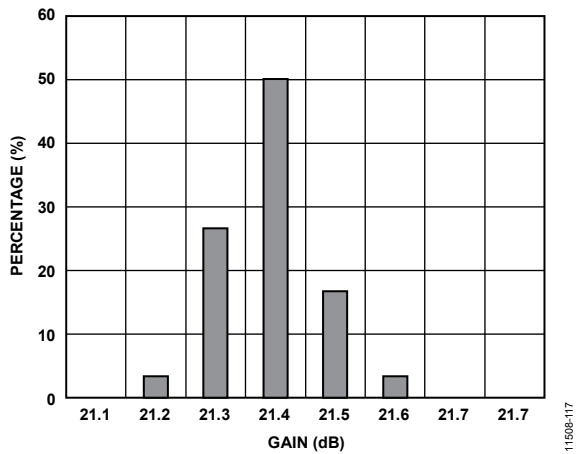

Figure 17. Gain Distribution at 1900 MHz

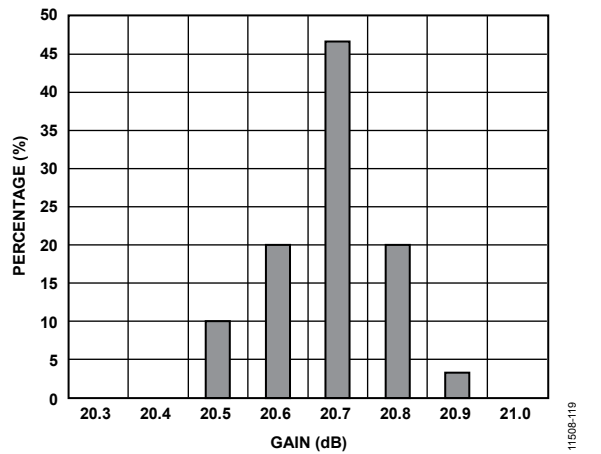

Figure 20. Gain Distribution at 2600 MHz

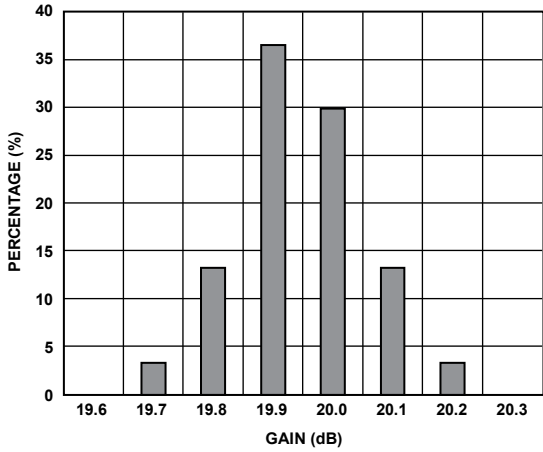

Figure 21. Gain Distribution at 4000 MHz

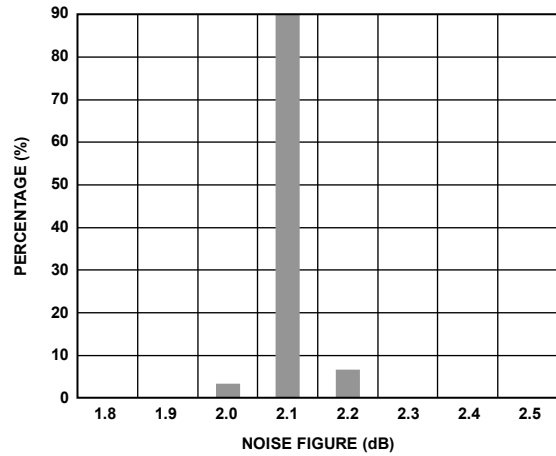

Figure 24. Noise Figure Distribution at 900 MHz

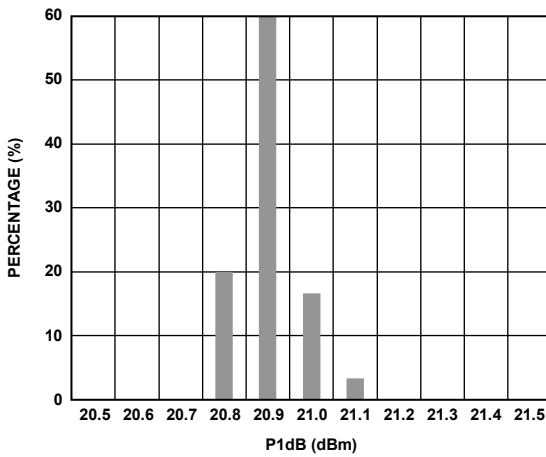

Figure 22. P1dB Distribution at 900 MHz

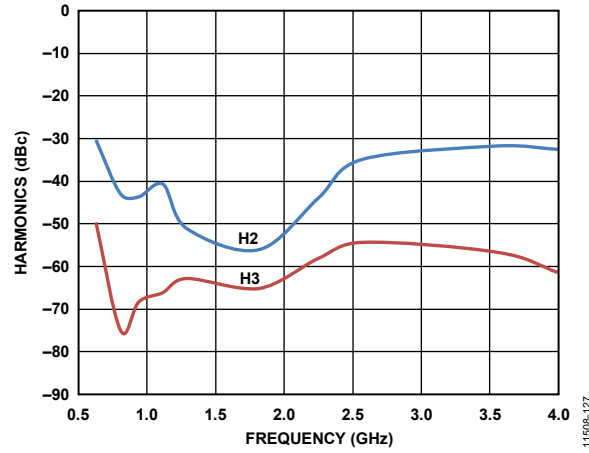

Figure 25. Single-Tone Harmonics vs. Frequency, P_{out} = 0 dBm

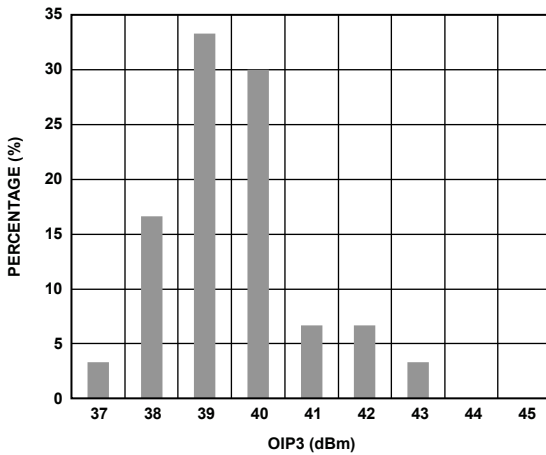

Figure 23. OIP3 Distribution at 900 MHz, P_{out} = 0 dBm per Tone

APPLICATIONS INFORMATION

BASIC CONNECTIONS

Figure 26 shows the basic connections for operating the ADL5611. The device supports operation from 30 MHz to 6 GHz. However, for optimal performance at lower frequency bands, the board configuration must be adjusted. Table 6 lists the recommended board configuration to operate the device at various frequency bands.

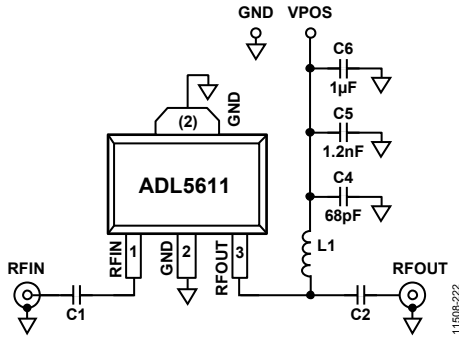

Figure 26. Basic Connections

A 5 V dc bias is supplied to the amplifier through the bias inductor connected to RFOUT (Pin 3). Decouple the bias voltage using 68 pF, 1.2 nF, and 1 μ F power supply decoupling capacitors. The typical current consumption for the ADL5611 is 94 mA.

At low frequencies, the device exhibits improved performance with the suggested setup configuration listed in Table 6. Figure 27 and Figure 28 provide a comparison of the performance of the device at the 30 MHz to 500 MHz band when driven with the optimal setup configuration and the default setup configuration.

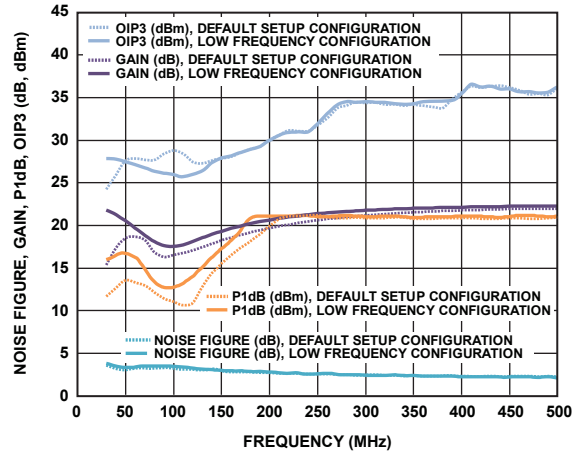

Figure 27. Noise Figure, Gain, P1dB, and OIP3 vs. Frequency, 30 MHz to 500 MHz, Comparison of Performance with the Optimized Settings and the Default Configuration

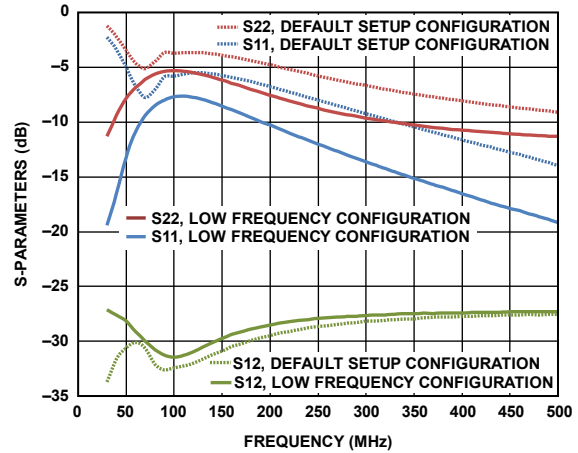

Figure 28. Output Return Loss (S22), Input Return Loss (S11), and Reverse Isolation (S12), 30 MHz to 500 MHz, Comparison of Performance with the Optimized Settings and the Default Configuration

Table 6. Recommended Components for Basic Connections

Frequency Band	AC Coupling Capacitors (0402)		DC Bias Inductor (0603HP)
	C1 (nF)	C2 (nF)	L1 (nH)
500 MHz to 6 GHz	100	100	43
30 MHz to 500 MHz	100	100	1000

SOLDERING INFORMATION AND RECOMMENDED PCB LAND PATTERN

Figure 29 shows the recommended land pattern for the ADL5611. To minimize thermal impedance, the exposed pad on the underside of the SOT-89 package is soldered to a ground plane, along with Pin 2. If multiple ground layers exist, stitch the layers together using vias.

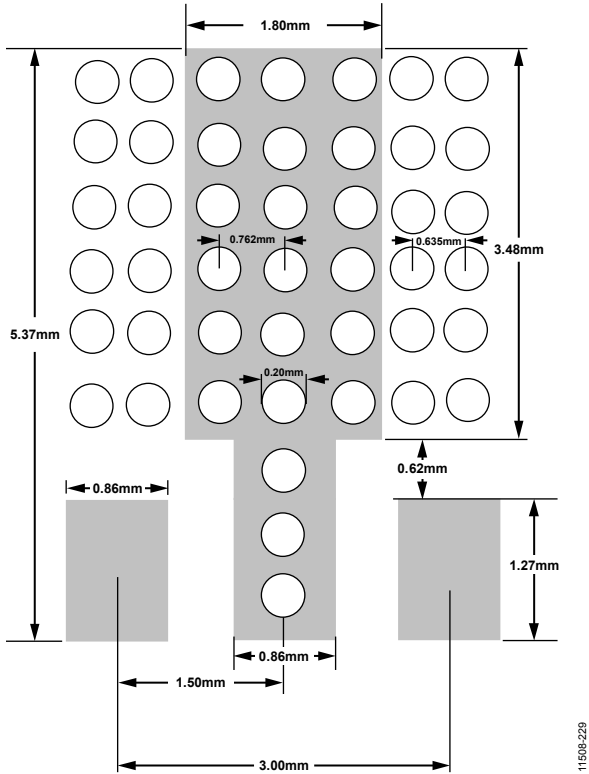

Figure 29. Recommended Land Pattern

The land pattern on the ADL5611 evaluation board provides a measured thermal resistance (θ_{JA}) of 52°C/W. To measure θ_{JA} , the temperature at the top of the SOT-89 package is sensed with an IR temperature gun.

Thermal simulation suggests a junction temperature that is 10°C higher than the top of package temperature. With additional measurements of the ambient temperature and input/output power, θ_{JA} can be determined.

W-CDMA ACPR PERFORMANCE

Figure 30 shows a plot of the adjacent channel power ratio (ACPR) vs. P_{OUT} for the ADL5611. The signal type used is a single wideband code division multiple access (W-CDMA) carrier (Test Model 1-64) at 2140 MHz. This signal is generated by a very low ACPR source. ACPR is measured at the output by a high dynamic range spectrum analyzer that incorporates an instrument noise correction function.

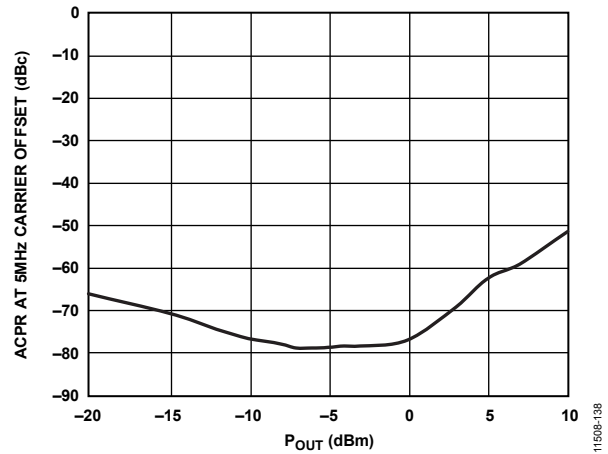

Figure 30. ACPR vs. P_{OUT} , Single W-CDMA Carrier (Test Model 1-64) at 2140 MHz

The ADL5611 achieves an ACPR of -79 dBc at an output power level of -5 dBm, at which point the device noise and not distortion begins to dominate the power in the adjacent channels. At an output power level of 5 dBm, ACPR is still very low at -62 dBc.

EVALUATION BOARD

Figure 31 shows the ADL5611 evaluation board layout. Figure 32 shows the schematic for the evaluation board. The board is powered by a single 5 V supply. Table 7 lists the components used on the evaluation board. Power can be applied to the board through clip on terminals (VCC and GND).

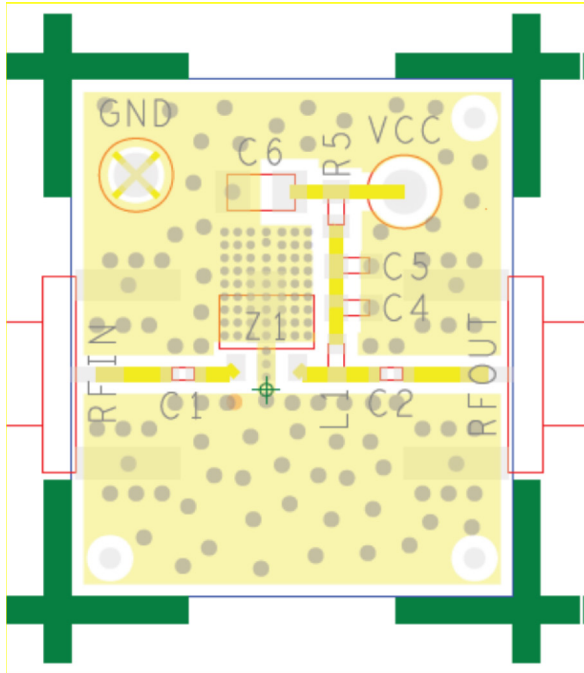

Figure 31. Evaluation Board Layout (Top)

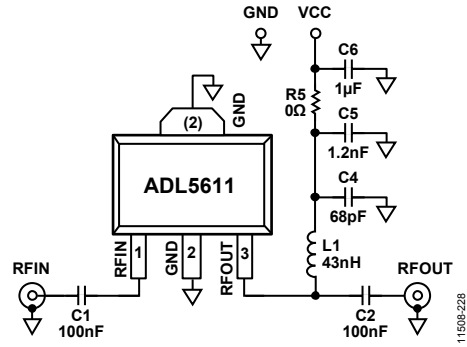
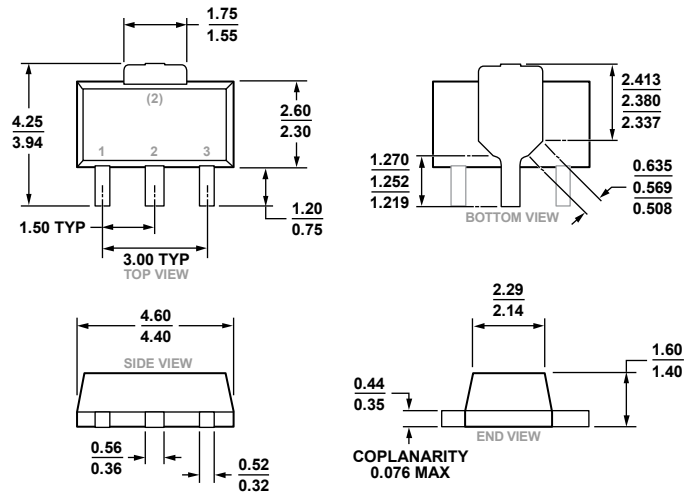

Figure 32. Evaluation Board Schematic

Table 7. Evaluation Board Configuration Options

Component	Description	Default Value
C1, C2	AC coupling capacitors	C1, C2 = 100 nF, 0402
L1	DC bias inductor	L1 = 43 nH, 0603 (Coilcraft 0603HP or equivalent)
R5	Bias resistor	R5 = 0 Ω, 0402
VCC and GND	Clip on terminals for power supply	Not applicable
C4, C5, C6	Power supply decoupling capacitors	C4 = 68 pF, 0603; C5 = 1.2 nF, 0603; C6 = 1 μF, 1206

OUTLINE DIMENSIONS



COMPLIANT TO JEDEC STANDARDS TO-243

Figure 33. 3-Lead Small Outline Transistor Package [SOT-89] (RK-3)

Dimensions shown in millimeters

ORDERING GUIDE

Model ¹	Temperature Range	Package Description	Package Option
ADL5611ARKZ-R7	-40°C to +105°C	3-Lead Small Outline Transistor Package [SOT-89], 7" Tape and Reel	RK-3
ADL5611-EVALZ	-40°C to +105°C	Evaluation Board	

¹ Z = RoHS Compliant Part.

Компания «Life Electronics» занимается поставками электронных компонентов импортного и отечественного производства от производителей и со складов крупных дистрибьюторов Европы, Америки и Азии.

С конца 2013 года компания активно расширяет линейку поставок компонентов по направлению коаксиальный кабель, кварцевые генераторы и конденсаторы (керамические, пленочные, электролитические), за счёт заключения дистрибьюторских договоров

Мы предлагаем:

- Конкурентоспособные цены и скидки постоянным клиентам.
- Специальные условия для постоянных клиентов.
- Подбор аналогов.
- Поставку компонентов в любых объемах, удовлетворяющих вашим потребностям.
- Приемлемые сроки поставки, возможна ускоренная поставка.
- Доставку товара в любую точку России и стран СНГ.
- Комплексную поставку.
- Работу по проектам и поставку образцов.
- Формирование склада под заказчика.
- Сертификаты соответствия на поставляемую продукцию (по желанию клиента).
- Тестирование поставляемой продукции.
- Поставку компонентов, требующих военную и космическую приемку.
- Входной контроль качества.
- Наличие сертификата ISO.

В составе нашей компании организован Конструкторский отдел, призванный помогать разработчикам, и инженерам.

Конструкторский отдел помогает осуществить:

- Регистрацию проекта у производителя компонентов.
- Техническую поддержку проекта.
- Защиту от снятия компонента с производства.
- Оценку стоимости проекта по компонентам.
- Изготовление тестовой платы монтаж и пусконаладочные работы.



Тел: +7 (812) 336 43 04 (многоканальный)

Email: org@lifeelectronics.ru