

Max. 28.5V Output 2Strings(25mA/ch) White LED Driver



BD65B60GWL

●General Description

BD65B60 is a white LED driver IC that integrates PWM step-up DC/DC converter with boost-capability of up to maximum 28.5V and current driver with drive capability of up to 25mA(Typ.) maximum setting. Precise brightness can be controlled at wide ranges through the external PWM pulse input.

This IC features highly accurate current drivers with low differential current errors between channels, thus, reducing brightness spots on the LCD panel. Moreover, its small package is suited for saving space.

●Features

- High efficiency PWM step-up DC/DC converter
 $f_{SW1} = 1.1\text{MHz(Typ.)}$, $f_{SW2} = 0.60\text{MHz(Typ.)}$
- High accuracy & good matching current drivers (2ch)
- Soft Start function
- Drives up to 8 LEDs in series per channel
- Lower input voltage range requirement (2.7V to 5.5V)

●Applications

Backlight for smartphones, games, digital video cameras, digital single-lens reflexes, digital still cameras, digital photo frames, Portable DVD player, etc.

●Key Specifications

- Input voltage range: 2.7V to 5.5V
- Output voltage range: Max. 28.5V
- Operational LED Channel: 2ch or 1ch
- Switching frequency: 0.6MHz/1.1MHz(Typ.)
- LED Current per Channel: 25mA (Max.)
- LED current accuracy: $\pm 3.0\%$ (Max.)
- Quiescent current: 0 μ A (Typ.)
- Operating temperature range: -40°C to +85°C

●Package

W(Typ.) x D(Typ.) x H(Max.)
UCSP50L1 (12pin) 1.40mm x 1.80mm x 0.55mm

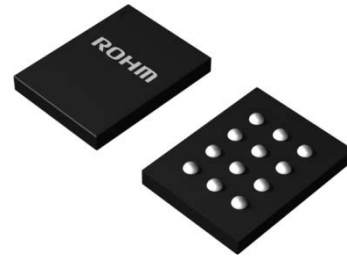

●Typical Application Circuit

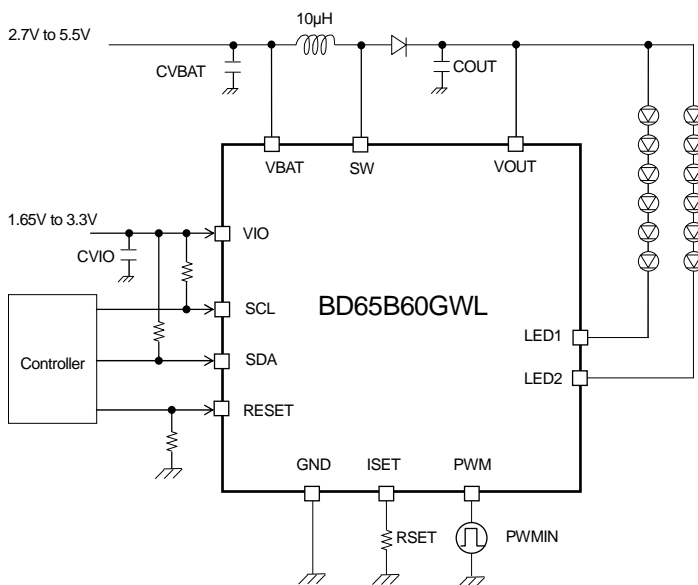

●Pin Configuration (Bottom View)

D	SW	VOUT	LED2
C	GND	RESET	LED1
B	VBAT	PWM	SCL
A	ISET	VIO	SDA
	1	2	3

● Pin Descriptions

PIN No.	PIN Name	I/O	Function	Terminal diagram
A1	ISET	In	Resistor Connection for LED Current setting	A
A2	VIO	In	VIO voltage Terminal. Connect a 1.65V to 3.3V supply to VIO and bypass to GND with a 0.1 μ F or greater ceramic capacitor.	B
A3	SDA	In	Serial Data input for I ² C Interface This pin is needed to connect external pull-up resistor to VIO pin. Please refer to P.37 "SDA, SCL Pull-up Resistor Selection."	B
B1	VBAT	In	VBAT voltage Terminal. Connect a 2.7V to 5.5V supply to VBAT and bypass to GND with a 1.0 μ F(Typ.) or greater ceramic capacitor.	C
B2	PWM	In	Input pin for controlling the current driver. This pin has an internal pull-down resistor. Please refer to P.35 "Brightness Control"	B
B3	SCL	In	Serial Clock input for I ² C Interface This pin is needed to connect external pull-up resistor to VIO pin. Please refer to P.37 "SDA, SCL Pull-up Resistor Selection".	B
C1	GND	-	Power Ground for internal switching transistor	C
C2	RESET	In	Active-low reset. Pull this pin high to enable the IC. This pin is needed to connect external pull-down resistor. Please refer to P.29 "Functional Descriptions"	B
C3	LED1	In	Input terminal to Internal Current Driver. LED cathode connection.	B
D1	SW	Out	Switching terminal where an external inductor is connected. Internally connects to an NMOS switch. Connect the inductor as close as possible to SW terminal to reduce parasitic inductance and capacitance. Please refer to PCB layout of P.39.	B
D2	VOUT	In	Terminal for monitoring the output voltage of switching regulator. Also, detects SBD open and OVP. Please refer to P.31. Connect VOUT to the positive terminal of the output capacitor (COUT). Recommended COUT value is 1.0 μ F(Typ.) for DC mode or 2.2 μ F(Typ.) for PWM mode.	B
D3	LED2	In	Input terminal to Internal Current Driver. LED cathode connection.	B

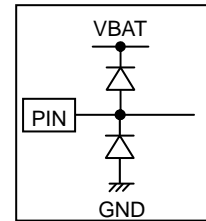

A

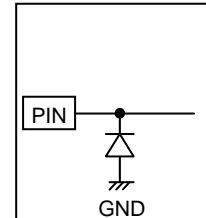

B

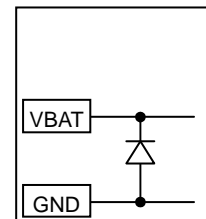

C

●Block Diagram

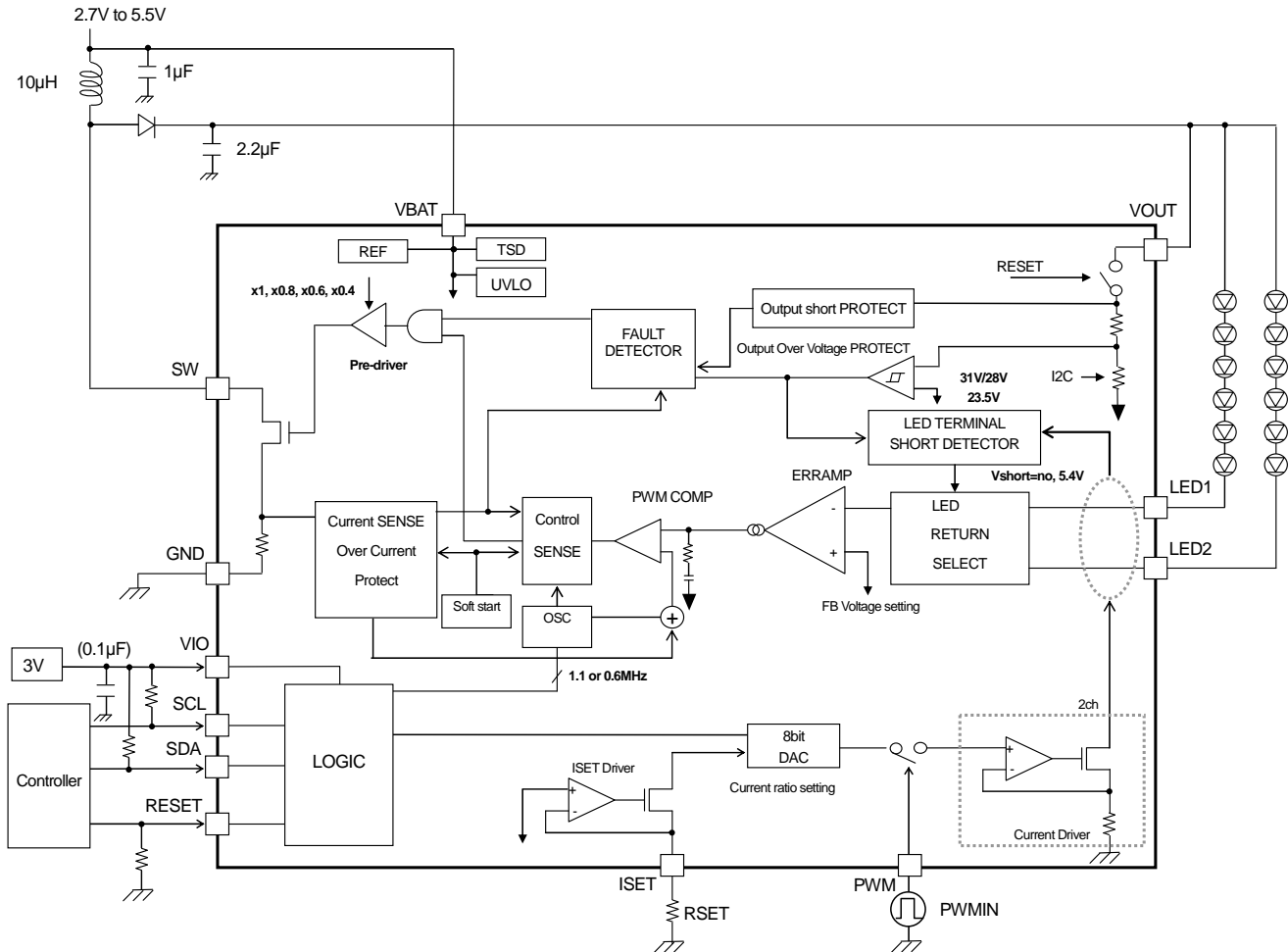

●Description of Block

The lowest voltage between LED1 and LED2 pins is detected when IC is powered on. Output voltage is kept constant by controlling the switching duty through the feedback voltage which is set at 0.3V(Typ.). The PWM Current Mode DC/DC Converter is controlled by the two inputs of the comparator: one is the differential output from the error amplifier and the other is the sum of current sensing and the ramp signal generated by the oscillator. These combined signals prevent the sub-harmonic oscillation in PWM Current Mode. The PWM output controls internal switch N-channel Transistor via the RS latch. Energy is accumulated in the external inductor when the gate of the N-channel transistor is “ON”, while energy is transferred to the output capacitor via external SBD when the N-channel transistor is “OFF”.

LED brightness is controlled by the current driver which can be set by: external resistor RSET, 8-bit DAC current ratio and PWM control that is selectable as DC or pulse input.

Furthermore, this IC has several protection functions such as thermal shutdown, over-current protection, under-voltage lockout, over-voltage protection, external SBD open detection, LED open and short detection. Their respective detection signals stop the switching operation instantly.

●Absolute Maximum Ratings (Ta=+25°C)

Parameter	Symbol	Limits	Unit	Condition
Maximum Applied Voltage 1	V _{MAX1}	7	V	VBAT, VIO, PWM, SDA, SCL, RESET, ISET
Maximum Applied Voltage 2	V _{MAX2}	34	V	SW, LED1, LED2, VOUT
Power Dissipation	Pd1	650	mW	Power dissipation derates by 5.2mW/ °C when operating above 25 °C (When mounted on ROHM's standard board) Power dissipation is calculated by formula : Pd=(Storage temperature max - 25°C) / θ _{JA} (ex. Pd1=5.2mW/°C)
Operating Temperature Range	Topr	-40 to +85	°C	-
Storage Temperature Range	Tstg	-55 to +150	°C	-

●Recommended Operating Ratings (Ta=+25°C)

Parameter	Symbol	Limits			Unit	Conditions
		Min.	Typ.	Max.		
Power Supply Voltage	V _{BAT}	2.7	3.6	5.5	V	Power supply
VIO Input Voltage (IO)	V _{IO}	1.65	3.0	3.3	V	I/O power supply (VIO≤VBAT)

●Electrical Characteristics (Unless otherwise specified, VBAT=3.6V, VIO=3.0V, Ta=+25°C)

Parameter	Symbol	Limits			Unit	Conditions
		Min.	Typ.	Max.		
[General]						
Quiescent Current (VBAT)	I _{QVBAT}	-	-	1.0	μA	RESET=0V
Quiescent Current (VIO)	I _{QVIO}	-	-	1.0	μA	RESET=0V
Standby Current (VBAT)	I _{STB}	-	2.0	4.0	μA	RESET=1.8V, ad0Eh, data=00h
Current Consumption (VBAT) for Current Driver 1ch	I _{BAT1ch}	-	0.80	-	mA	RESET=1.8V, VOUT=open Fsw=1.1MHz, ad03h, data=01h <No switching>
Current Consumption (VBAT) for Current Driver 2ch	I _{BAT2ch}	-	0.85	-	mA	RESET=1.8V, VOUT=open Fsw=1.1MHz, ad03h, data=05h <No switching>
Current Consumption (VIO)	I _{DDVIO}	-	-	100	μA	RESET=1.8V, VOUT=open SDA=SCL=50% @400kHz (3.0V)
[RESET, PWM Terminal]						
Low Level Input Voltage	V _{THL}	-	-	0.5	V	
High Level Input Voltage	V _{THH}	1.4	-	-	V	
RESET Input Current	I _{RSTin}	-	-	1	μA	
RESET Output Current	I _{RSTout}	-1	-	-	μA	
PWM Pull down Resistor	R _{PWM}	-	300	-	kΩ	
[SDA, SCL Terminal]						
Low Level Input Voltage	V _{ILI}	-0.3	-	0.25xVIO	V	
High Level Input Voltage	V _{IHI}	0.75xVIO	-	VIO+0.3	V	
L level Output Voltage (for SDA pin)	V _{OL}	-	-	0.3	V	IOL=3mA
Input Current	I _{Sin}	-3	-	3	μA	Input voltage = from (0.1 x VIO) to (0.9 x VIO)

●Electrical Characteristics (Unless otherwise specified, VBAT=3.6V, VIO=3.0V, Ta=+25°C)

Parameter	Symbol	Limits			Unit	Conditions
		Min.	Typ.	Max.		
[Switching Regulator]						
LED Control Voltage1	V _{LED1}	0.40	0.50	0.60	V	ad02h,data=00h
LED Control Voltage2	V _{LED2}	-	0.40	-	V	ad02h,data=01h
LED Control Voltage3	V _{LED3}	-	0.30	-	V	ad02h,data=02h
LED Control Voltage4	V _{LED4}	-	0.20	-	V	ad02h,data=03h
Switching Frequency Accuracy	F _{SW}	0.88	1.10	1.32	MHz	FOSC(ad02h D2)=1
Duty Cycle Limit	D _{MAX}	90.0	95.0	99.0	%	LED1-2=0.3V, Fsw=1.1MHz
SW Nch FET RON	R _{ON}	-	0.3	-	Ω	ISW=80mA, VBAT=3.6V
SW Transistor Leak Current	I _{QSW}	-	0.1	2.0	μA	RESET =0V, SW=18V
VOUT Range	V _{RANGE}	VBAT+1V	-	OVP-1V	V	Under OVP voltage
[Protection]						
Under Voltage Lock Out (fall)	V _{UVLO}	-	2.1	-	V	VBAT falling edge
Under Voltage Lock Out (rise)	V _{UVLOH}	-	2.3	-	V	VBAT rising edge
Over Current Limit 1	I _{Ocp1}	-	1000	-	mA	VBAT=2.7V, ad01h,data=01h *1
Over Current Limit 2	I _{Ocp2}	-	1700	-	mA	VBAT=2.7V, ad01h,data=00h *1
Over Voltage Limit Input1	V _{OVP1}	29.5	31	33	V	VOUT rising edge, ad01h,data=10h
Over Voltage Limit Input2	V _{OVP2}	27	28	29.5	V	VOUT rising edge, ad01h,data=01h
Over Voltage Limit Input3	V _{OVP3}	22.5	23.5	24.7	V	VOUT rising edge, ad01h,data=00h or 11h
Over Voltage Limit Hysteresis	V _{OVP_{Phys}}	-	1	-	V	
Output Short Protect	V _{OVP_{fault}}	-	0.2	0.5	V	Detect voltage of VOUT pin
VOUT Leak Current	I _{OVL}	-	0.1	1.0	μA	RESET=0V, VOUT=18V (OVP=31V)
LED Terminal Over Voltage Protect	V _{SC}	4.5	5.4	6.3	V	
[Current driver]						
LED Maximum Current Setting Range	I _{LMAX}	5.0	-	25.0	mA	This value is characteristics of current driver.
LED current Step	I _{LEDSTP}	-	256	-	step	LED1, 2
LED Current Accuracy 1	I _{LACCU1}	-	-	±3.0	%	IMAX=15.0mA
LED Current DAC Linearity 1 (Design target)	I _{DALIN1}	-	-	±2.0	%	range = 10.02mA to 15mA RSET resistor =15.0mA setting *2 DAC register : ad05h, data=AAh to FFh
LED Current DAC Linearity 2 (Design target)	I _{DALIN2}	-	-	±3.0	%	range = 5.04mA to 9.96mA RSET resistor =15.0mA setting *2 DAC register : ad05h, data=55h to A9h
LED Current Matching	I _{LMAT}	-	-	2.0	%	(Max LED current – average current) / average current
LED Current Limit	I _{LOCP}	-	0	0.1	mA	Current Limit Value at ISET Resistor 1kΩ Setting
LED Leak Current	I _{QLED}	-	0.1	1.0	μA	RESET=0V, LED1&LED2=18V

*1 This parameter is tested with DC measurement

*2 condition: RSET resistor = 40kΩ, I_{LED} = 15.0mA setting
calculation: IDALIN1=(ILED(XXh)/ILED(FFh) x 256/(XXh+1)) - 1

●Evaluation Data

Evaluation data is measured using below parts and condition. (Unless otherwise specified)

Coil : 1277AS-H-4R7M

SBD : RB160VA-40

VIO=3.0V

PWM=0V(GND)

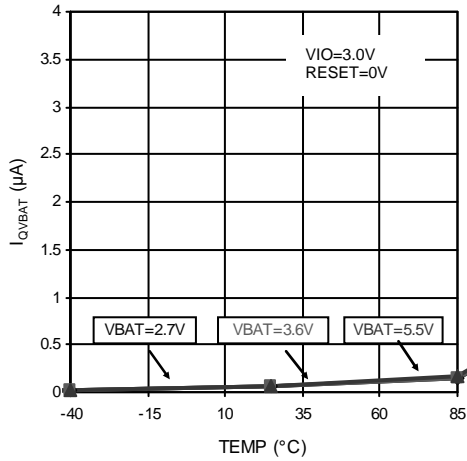

Figure 1. Quiescent Current (VBAT) vs Temperature

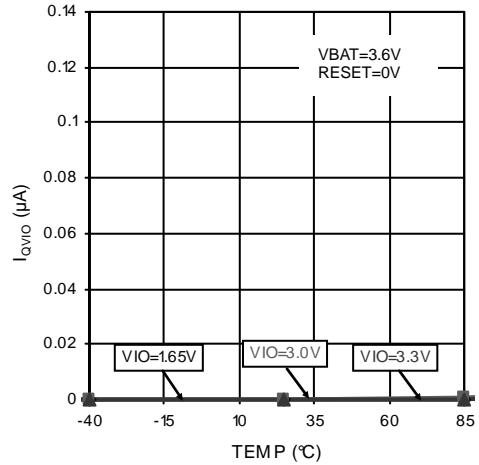

Figure 2. Quiescent Current (VIO) vs Temperature

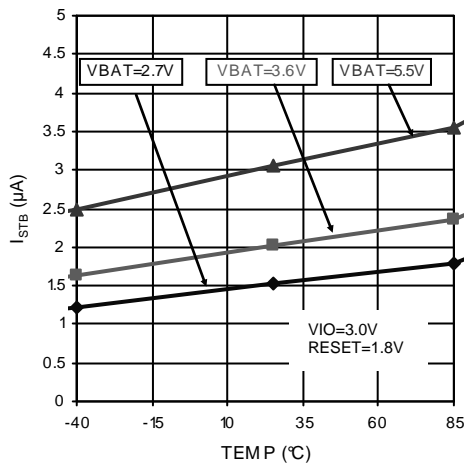

Figure 3. Standby Current (VBAT) vs Temperature

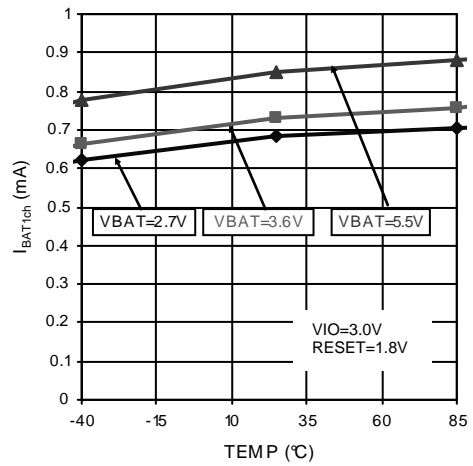

Figure 4. Current Consumption (VBAT) 1CH vs Temperature <No switching>

●Evaluation Data -continued

Evaluation data is measured using below parts and condition. (Unless otherwise specified)

Coil : 1277AS-H-4R7M
 SBD : RB160VA-40

VIO=3.0V
 RESET=2.5V
 PWM=0V(GND)

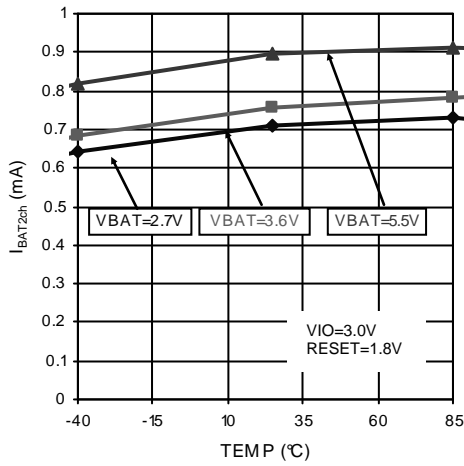

Figure 5. Current Consumption (VBAT) 2CH vs Temperature <No switching>

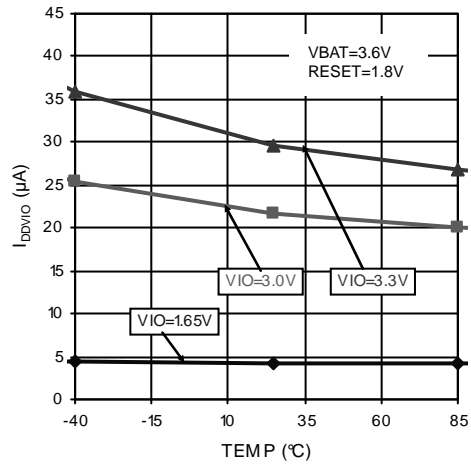

Figure 6. Current Consumption (VIO) vs Temperature

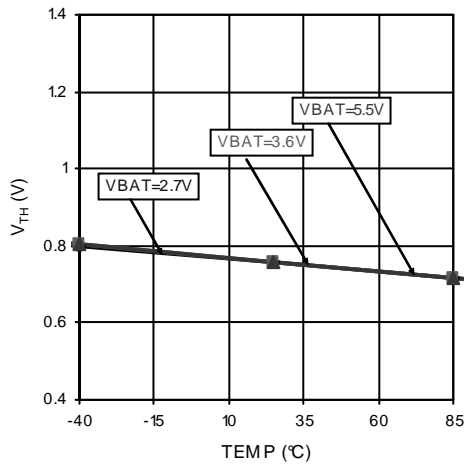

Figure 7. Reset Threshold Voltage vs Temperature

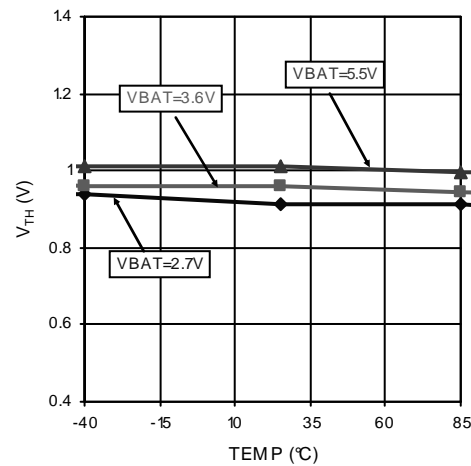

Figure 8. PWM Threshold Voltage vs Temperature

●Evaluation Data -continued

Evaluation data is measured using below parts and condition. (Unless otherwise specified)

Coil : 1277AS-H-4R7M
 SBD : RB160VA-40

VIO=3.0V
 RESET=2.5V
 PWM=0V(GND)

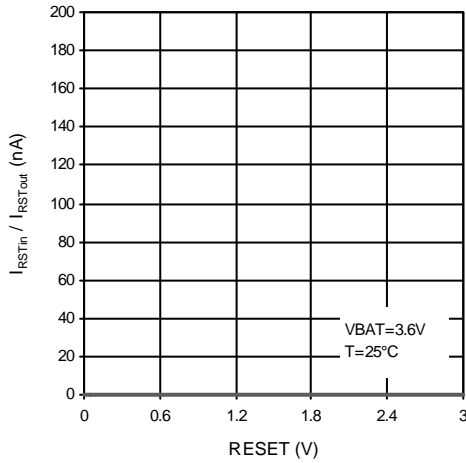

Figure 9. Reset Input and Output Current vs Reset Voltage

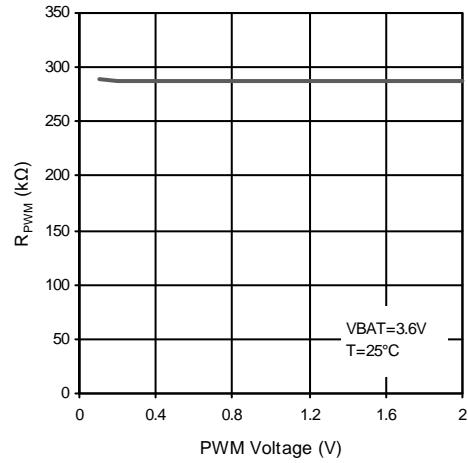

Figure 10. PWM Pull-Down Resistance vs PWM Voltage

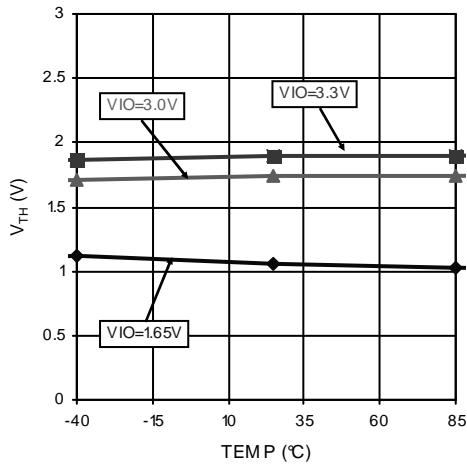

Figure 11. SDA Threshold Voltage vs Temperature

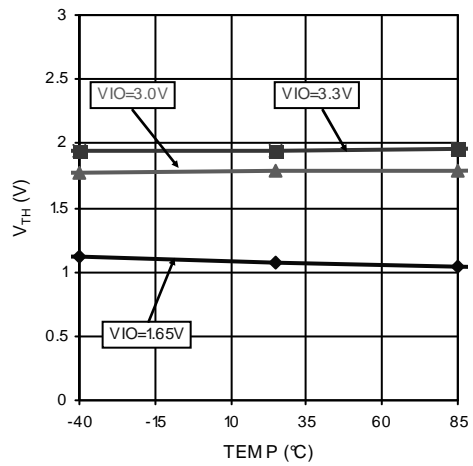

Figure 12. SCL Threshold Voltage vs Temperature

●Evaluation Data -continued

Evaluation data is measured using below parts and condition. (Unless otherwise specified)

Coil : 1277AS-H-4R7M

SBD : RB160VA-40

VIO=3.0V

RESET=2.5V

PWM=0V(GND)

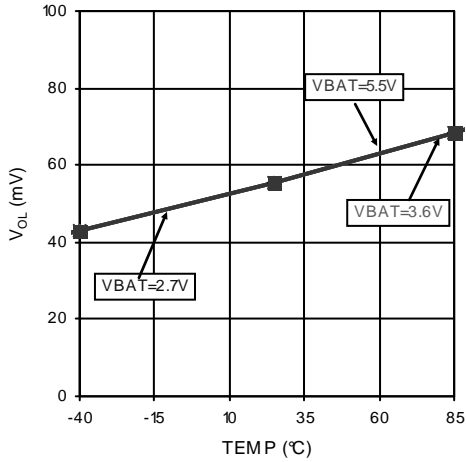

Figure 13. SDA "L" Level Output Voltage vs Temperature

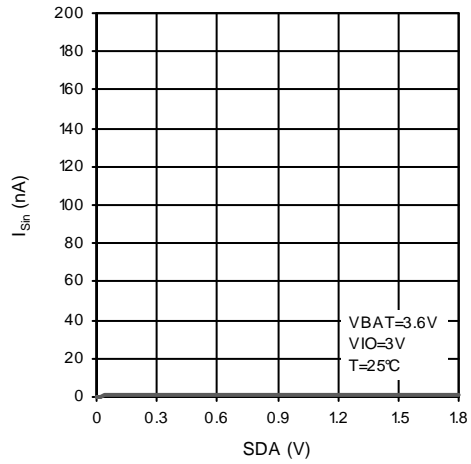

Figure 14. SDA Input Current vs SDA Voltage

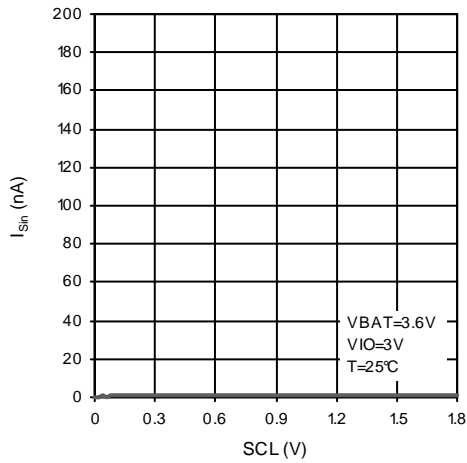

Figure 15. SCL Input Current vs SCL Voltage

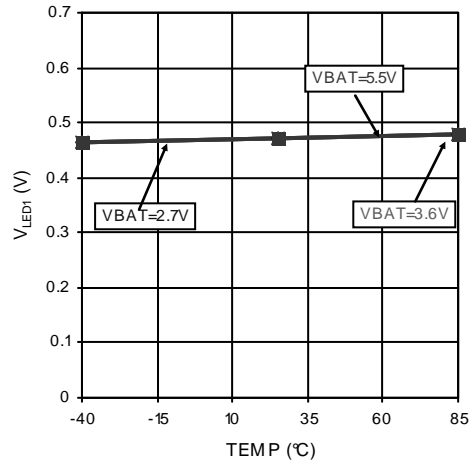

Figure 16. LED Control Voltage 1 vs Temperature (Feedback voltage=0.5V setting)

●Evaluation Data -continued

Evaluation data is measured using below parts and condition. (Unless otherwise specified)

Coil : 1277AS-H-4R7M

SBD : RB160VA-40

VIO=3.0V

RESET=2.5V

PWM=0V(GND)

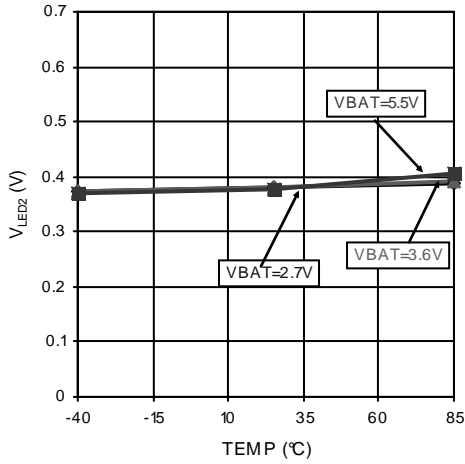

Figure 17. LED Control Voltage 2 vs Temperature (Feedback voltage=0.4V setting)

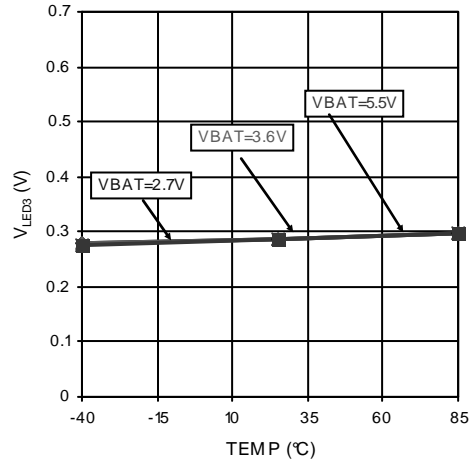

Figure 18. LED Control Voltage 3 vs Temperature (Feedback voltage=0.3V setting)

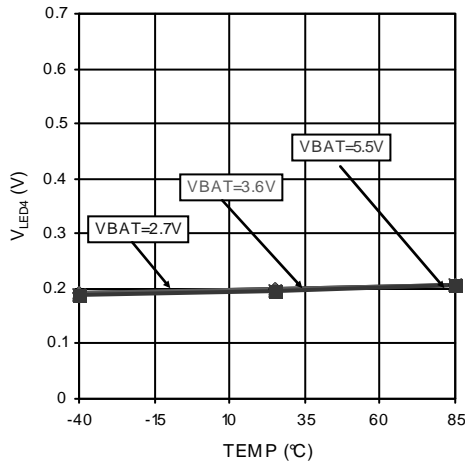

Figure 19. LED Control Voltage 4 vs Temperature (Feedback voltage=0.2V setting)

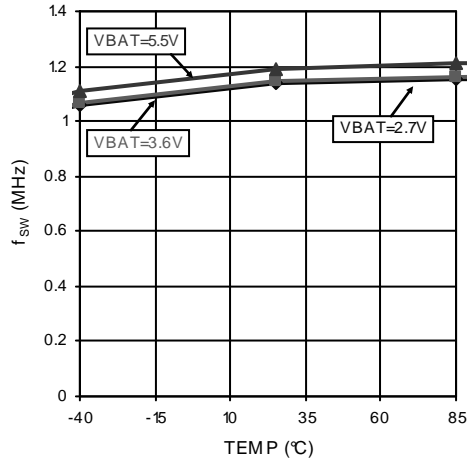

Figure 20. Switching Frequency (1.1MHz) vs Temperature

●Evaluation Data -continued

Evaluation data is measured using below parts and condition. (Unless otherwise specified)

Coil : 1277AS-H-4R7M

SBD : RB160VA-40

VIO=3.0V

RESET=2.5V

PWM=0V(GND)

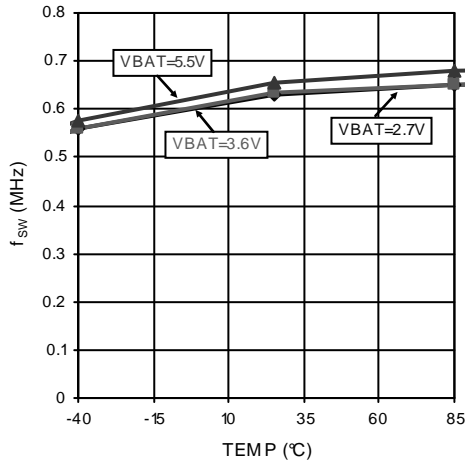

Figure 21. Switching Frequency (0.6MHz) vs Temperature

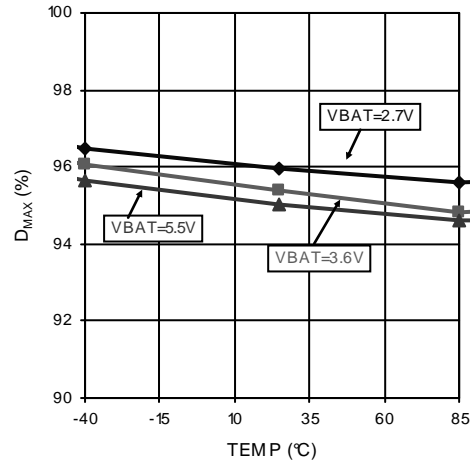

Figure 22. Maximum Duty Cycle Limit vs Temperature

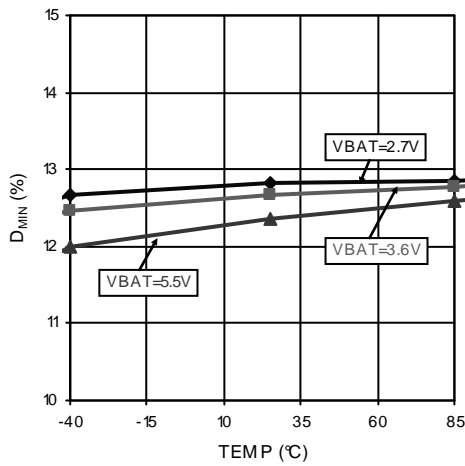

Figure 23. Minimum Duty Cycle Limit vs Temperature

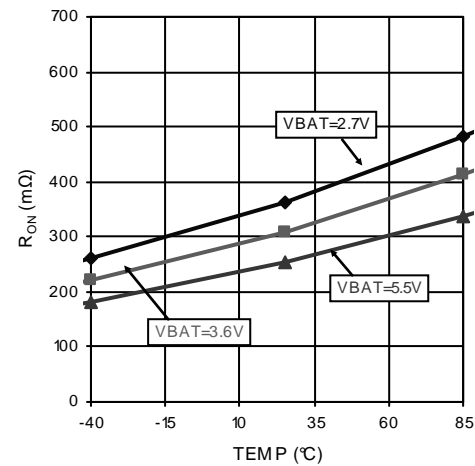

Figure 24. SW Nch FET RON (at $I_{SW}=80mA$) vs Temperature

●Evaluation Data -continued

Evaluation data is measured using below parts and condition. (Unless otherwise specified)

Coil : 1277AS-H-4R7M

SBD : RB160VA-40

VIO=3.0V

RESET=2.5V

PWM=0V(GND)

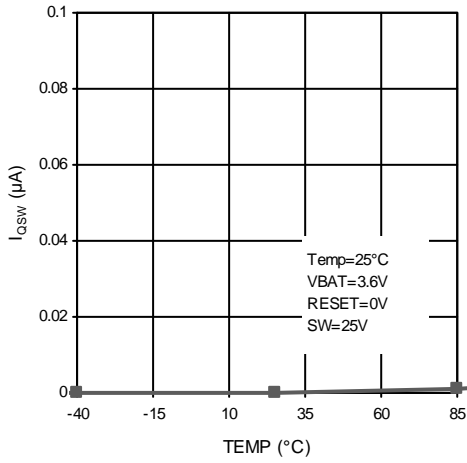

Figure 25. SW Leak Current vs Temperature

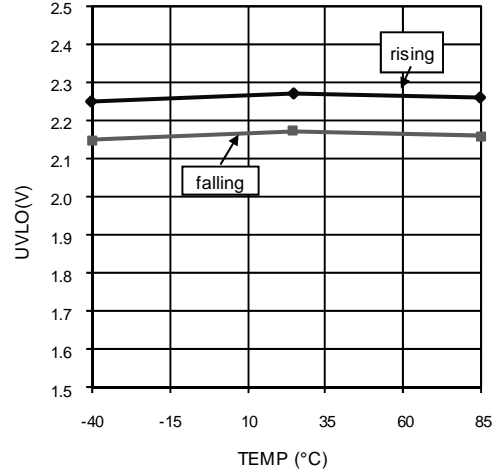

Figure 26. Under Voltage Lock Out (Rise/Fall)

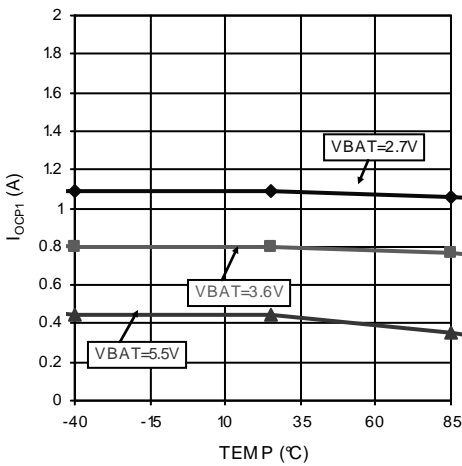

Figure 27. Current Limit (1A) vs Temperature

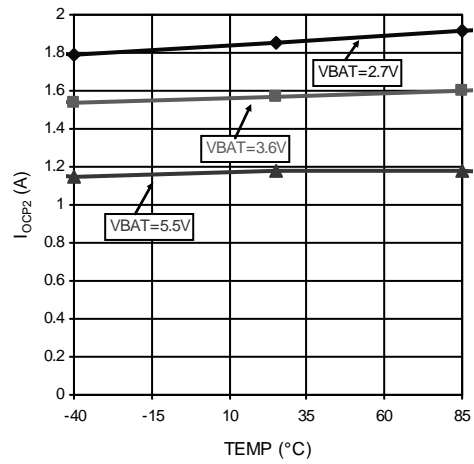

Figure 28. Current Limit (1.7A) vs Temperature

●Evaluation Data -continued

Evaluation data is measured using below parts and condition. (Unless otherwise specified)

Coil : 1277AS-H-4R7M

SBD : RB160VA-40

VIO=3.0V

RESET=2.5V

PWM=0V(GND)

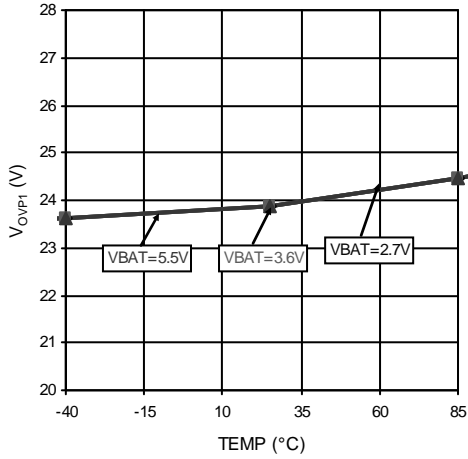

Figure 29. Over Voltage Protection 1 (23.5V) vs Temperature

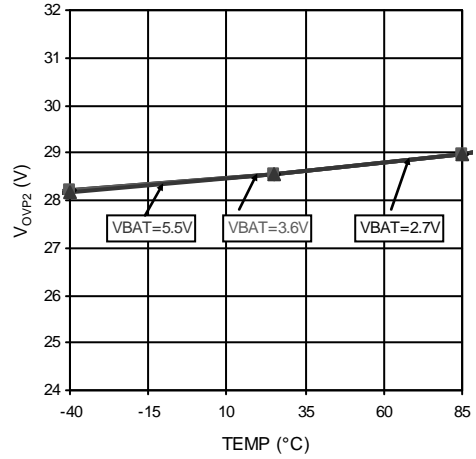

Figure 30. Over Voltage Protection 2 (28V) vs Temperature

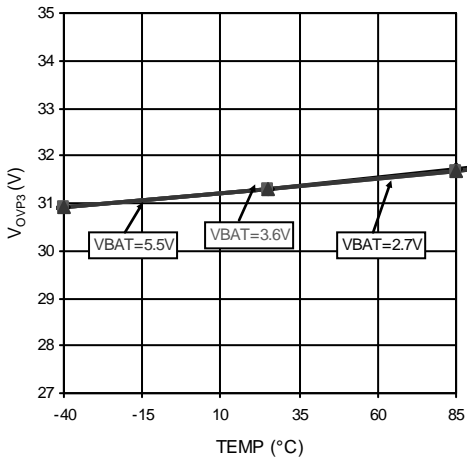

Figure 31. Over Voltage Protection 3 (31V) vs Temperature

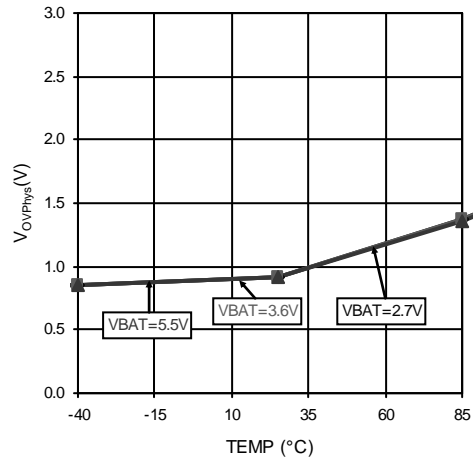

Figure 32. Over Voltage Protection Hysteresis vs Temperature

●Evaluation Data -continued

Evaluation data is measured using below parts and condition. (Unless otherwise specified)

Coil : 1277AS-H-4R7M

SBD : RB160VA-40

VIO=3.0V

RESET=2.5V

PWM=0V(GND)

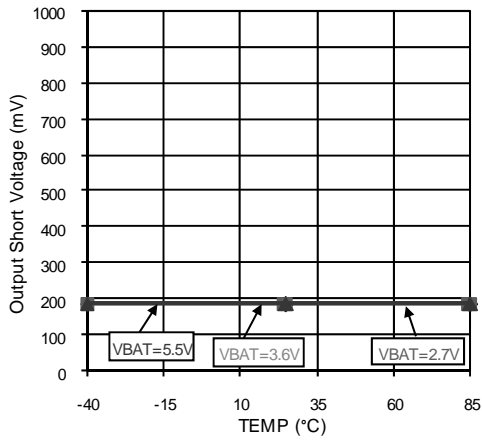

Figure 33. Output Short Protect

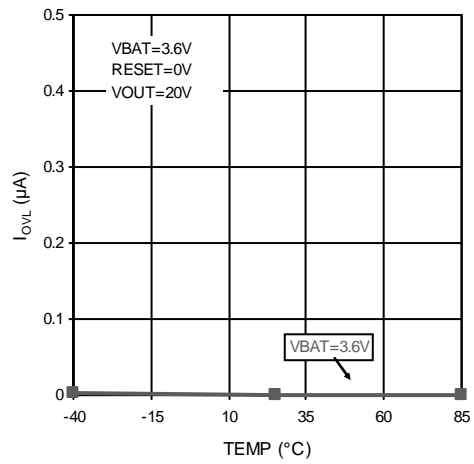

Figure 34. VOUT Leak Current vs Temperature

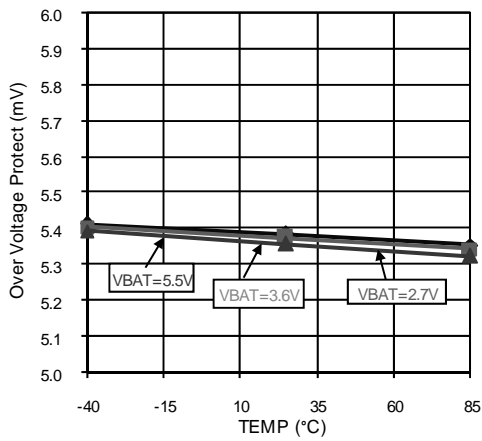

Figure 35. LED Terminal Over Voltage Protect vs Temperature

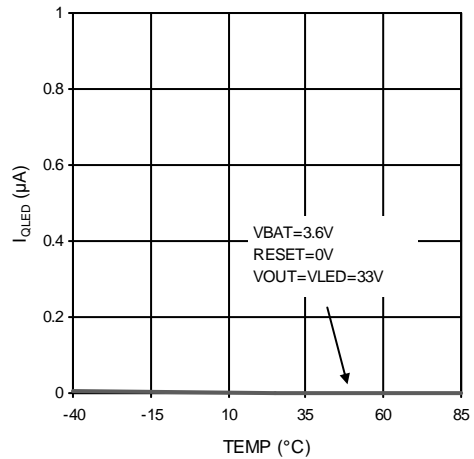

Figure 36. LED1, LED2 Leak Current vs Temperature

●Evaluation Data -continued

Evaluation data is measured using below parts and condition. (Unless otherwise specified)

Coil : 1277AS-H-4R7M
 SBD : RB160VA-40

VBAT=3.6V
 VIO=3.0V
 RESET=2.5V

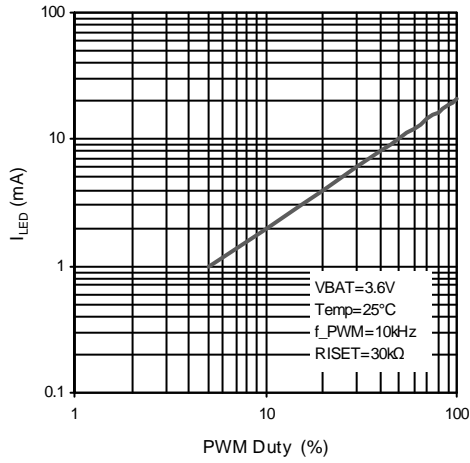

Figure 37. LED Current vs PWM Duty (PWM output mode)

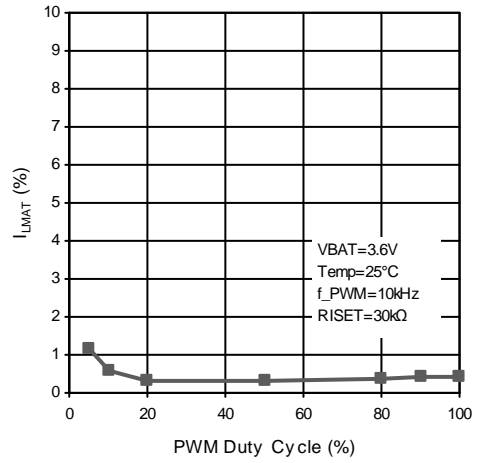

Figure 38. LED Current Matching vs PWM Duty (PWM output mode)

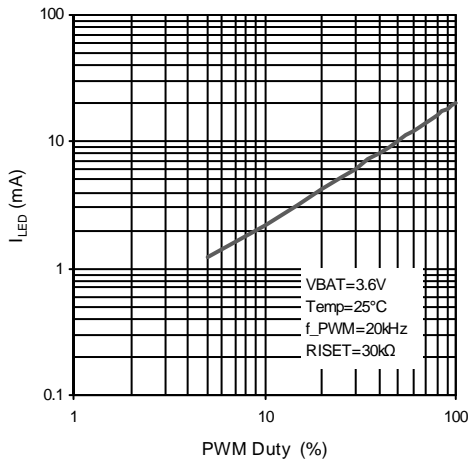

Figure 39. LED Current vs PWM Duty (DC output mode)

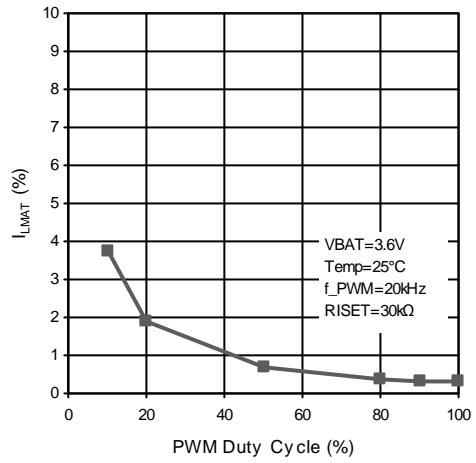

Figure 40. LED Current Matching vs PWM Duty (DC output mode)

●Evaluation Data -continued

Evaluation data is measured using below parts and condition. (Unless otherwise specified)

Coil : 1277AS-H-4R7M
 SBD : RB160VA-40

VIO=3.0V
 RESET=2.5V
 PWM=0V(GND)

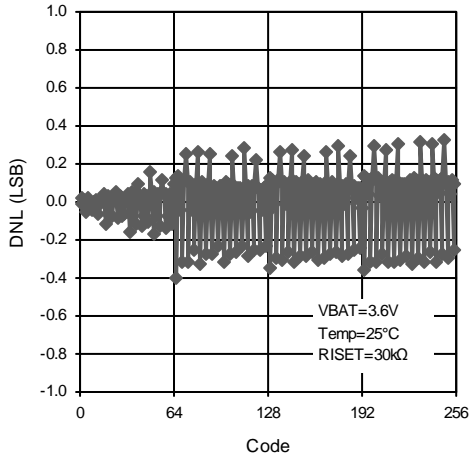

Figure 41. DNL vs LED Current Ratio

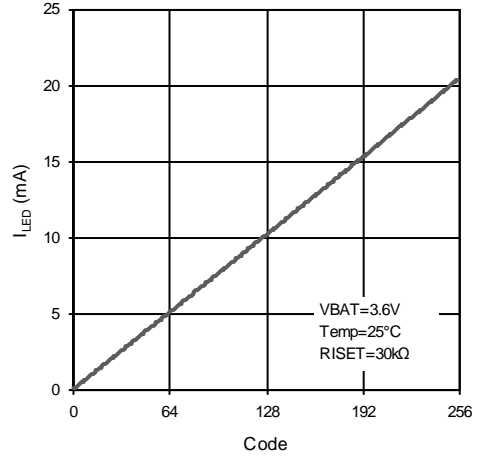

Figure 42. LED Current vs LED Current Ratio

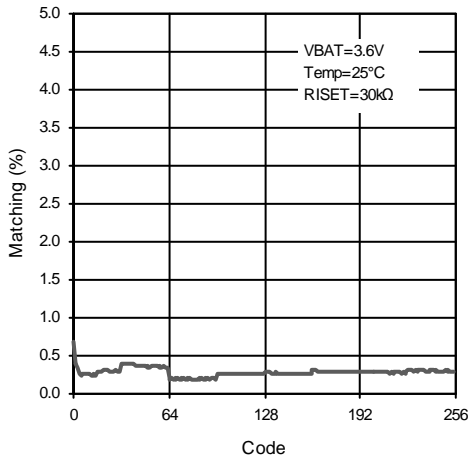

Figure 43. LED Current Matching vs LED Current Ratio

●Evaluation Data -continued

Evaluation data is measured using below parts and conditon. (Unless otherwise specified)

Coil : 1277AS-H-4R7M
 SBD : RB160VA-40

VIO=3.0V
 RESET=2.5V
 PWM=0V(GND)

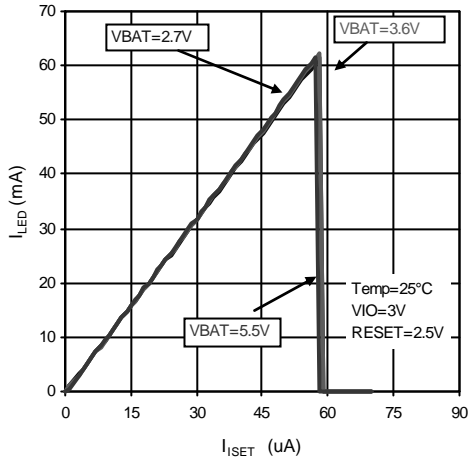

Figure 44. LED Current Limit vs ISET Current

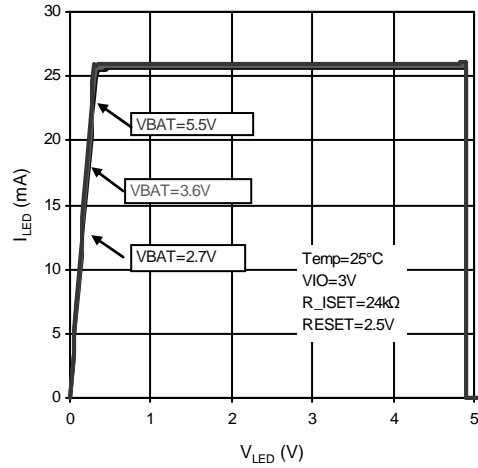

Figure 45. LED Current vs LED Voltage

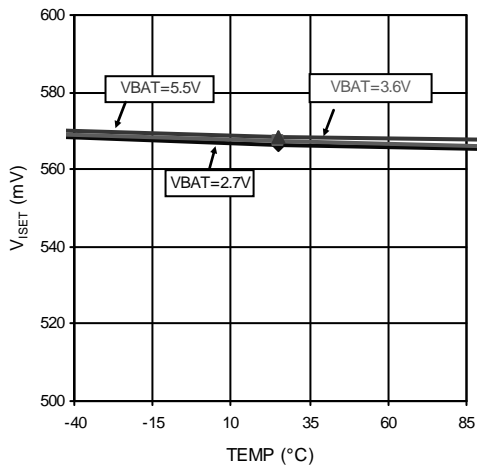

Figure 46. ISET Voltage vs Temperature

●Evaluation Data -continued

LED current is measured using below parts. (Unless otherwise specified)

Coil : 1277AS-H-4R7M
 SBD : RB160VA-40

VIO=1.8V
 RESET=2.5V
 PWM=0V(GND)

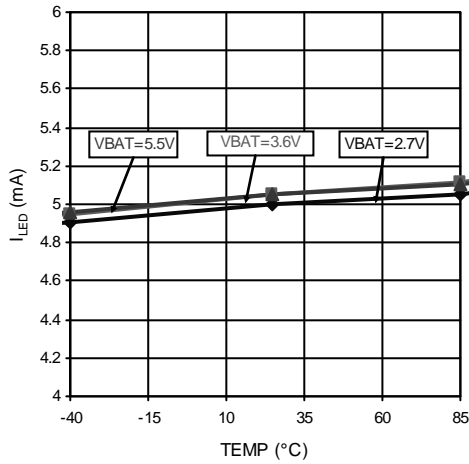

Figure 47. LED Current 5mA (RSET=120kΩ) vs Temperature

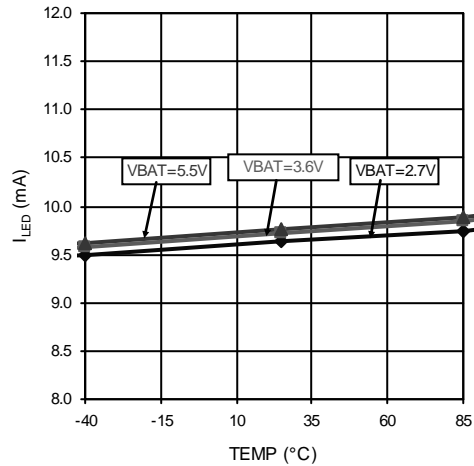

Figure 48. LED Current 10mA (RSET=62kΩ) vs Temperature

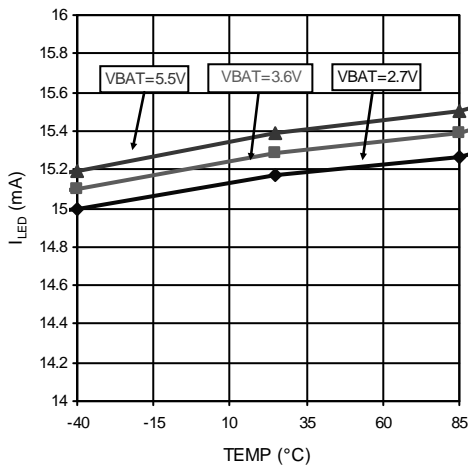

Figure 49. LED Current 15mA (RSET=39kΩ) vs Temperature

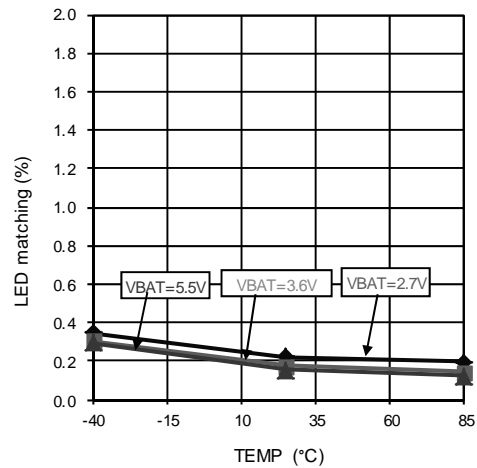

Figure 50. LED Current Matching 15mA (RSET=39kΩ) vs Temperature

●Typical Performance Curves

Conditions:
 VBAT=3.6V, Ta=25°C, Fsw=0.6MHz, LED 6series x 1string and 2strings

(1) FB=0.3V setting

Efficiency is calculated using the following equation:

$$\text{Efficiency} = (\text{VOUT} \times \text{LED current}) / (\text{VBAT} \times \text{Input current})$$

LED current is calculated using the following equation:

$$\text{LED current} = \text{max current} \times \text{ratio} \times \text{PWM duty}$$

Where:

max current is 12mA set by RSET, which is the resistor connected to ISET terminal.

ratio is controlled by register (ad05h D[7:0])

PWM duty is equal to 100%

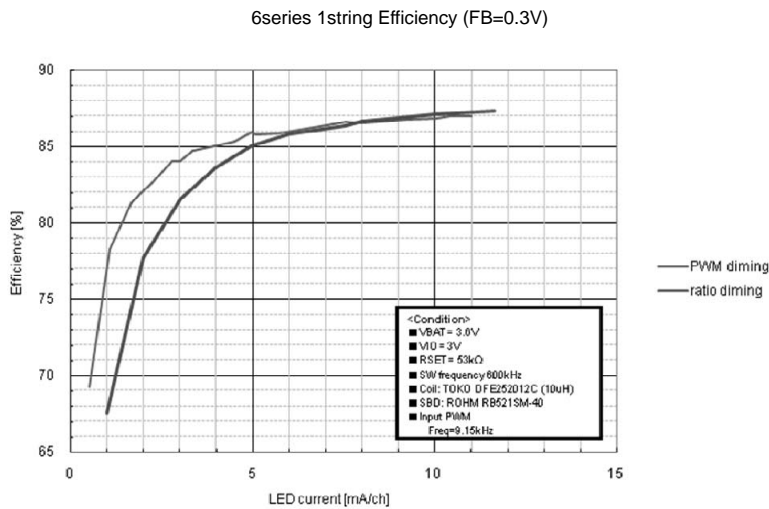

(2) FB=0.5V setting

Efficiency is calculated using the following equation:

$$\text{Efficiency} = (\text{VOUT} \times (\text{LED1} + \text{LED2 current})) / (\text{VBAT} \times \text{Input current})$$

LED current is calculated using the following equation:

$$\text{LED current} = \text{max current} \times \text{ratio} \times \text{PWM duty}$$

Where:

max current is 25mA set by RSET, which is the resistor connected to ISET terminal.

ratio is controlled by register (ad05h D[7:0])

PWM duty is equal to 100%

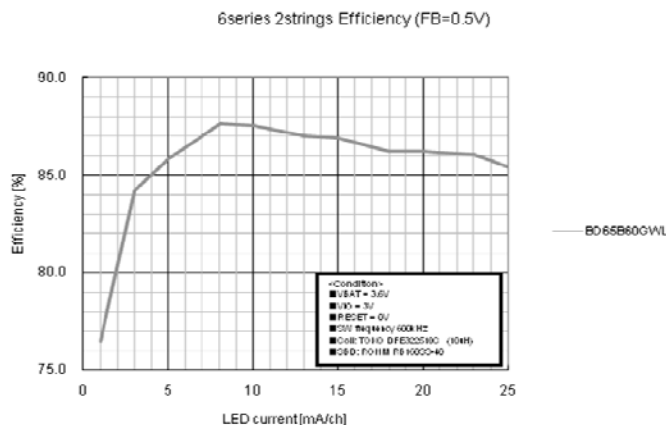

●Control Signal Input Timing

Timing sequence (VBAT, VIO, RESET, I²C (SDA, SCL))
 VBAT voltage > VIO voltage

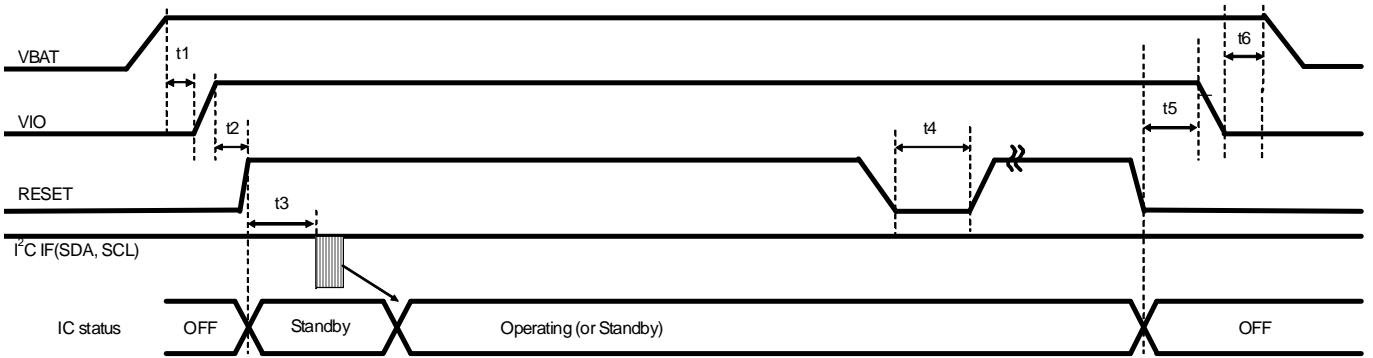

Figure 51. Timing Diagram

Table 1. Input Timing

Symbol	Name	Unit	Min.	Typ.	Max.
t1	Power Supply(IC) – Power supply (IO) time	μs	100	-	-
t2	Power Supply(IO) – RESET wait time	μs	0	-	-
t3	RESET – I ² C wait time	μs	100	-	-
t4	RESET low width	μs	50	-	-
t5	RESET - Power Supply(IO) time	μs	0	-	-
t6	Power Supply(IO) - Power Supply(IC)	μs	0	-	-

●Serial Interface

It can interface with I²C BUS format compatible.

(1) Slave address

A7	A6	A5	A4	A3	A2	A1	R/W
1	1	0	0	1	0	0	1/0

Figure 52. Slave Address

(2) Bit Transfer

SCL transfers 1-bit data during each clock pulse and data is sampled at “H” state. SDA cannot be changed at the time of bit transfer. Any changes on the SDA while SCL is in H state, a START condition or a STOP condition will occur and it will be interpreted as a control signal.

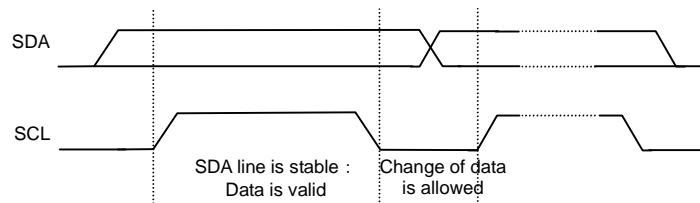

Figure 53. Bit transfer (I²C format)

(3) START and STOP condition

When SDA changes state while SCL is H, data is not transferred on the I²C bus. Two conditions might occur if this happens. If SDA changes from H to L while SCL is H, it will become START (S) condition which signals the beginning of a new command. If SDA changes from L to H while SCL is H, it will become STOP (P) condition which signals the end of the previous command.

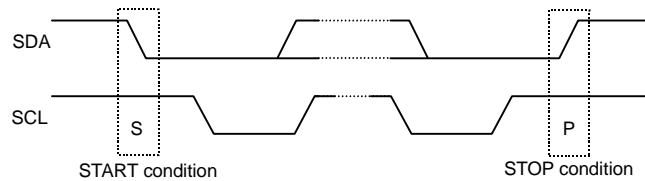

Figure 54. START/STOP condition (I²C format)

(4) Acknowledge

Transfer of 8-bit data occurs after each START condition. After eight bits had been sent, the transmitter opens SDA while the receiver returns the acknowledge signal by setting SDA to L. Acknowledge is returned between address 00h and 0Eh.

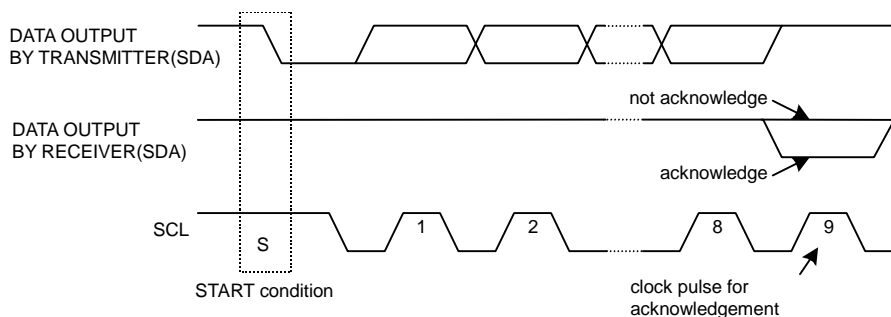

Figure 55. Acknowledge (I²C format)

(5) Write protocol

A register address is transferred by the next 1 byte that transferred the slave address and the write-in command. The 3rd byte writes data in the internal register written in by the 2nd byte, and after the 4th byte or, the increment of register address is carried out automatically. However, when a register address turns into the last address 0Eh, it is set to 00h by the next transmission. After the transmission ends, the increment of the address is carried out.

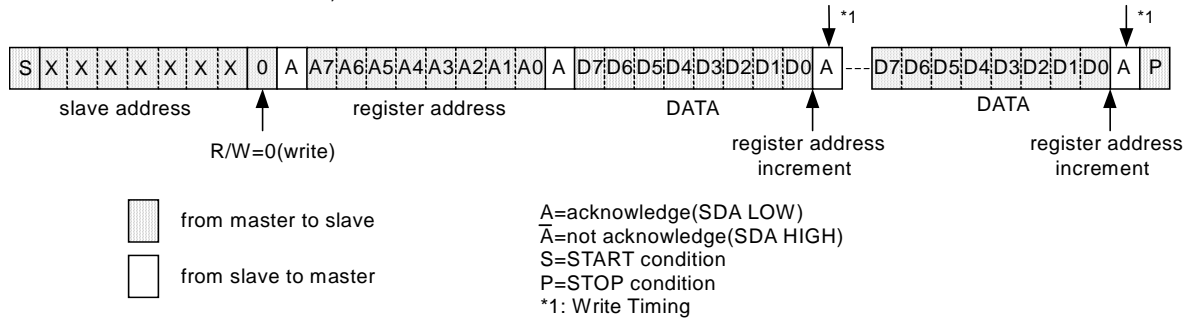

Figure 56. Writing protocol

(6) Read protocol

It reads from the next byte after writing a slave address and R/W bit. The register to read is consider as the following address accessed at the end, and the data of the address that carried out the increment is read after it. If an address turns into the last address 0Eh, the next byte will read out 00h. After the transmission end, the increment of the address is carried out.

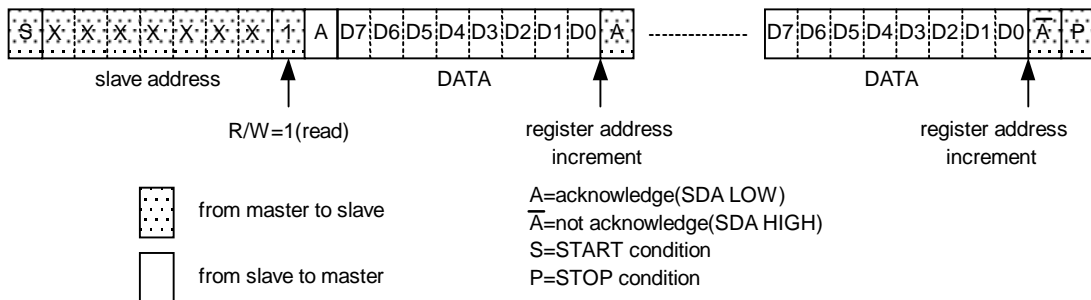

Figure 57. Reading protocol

(7) Multiple Read protocol

After specifying an internal address, it reads by repeated START condition and changing the data transfer direction. The data of the address that carried out the increment is read after it. If an address turns into the last address 0Eh, the next byte will read out 00h. After the transmission end, the increment of the address is carried out.

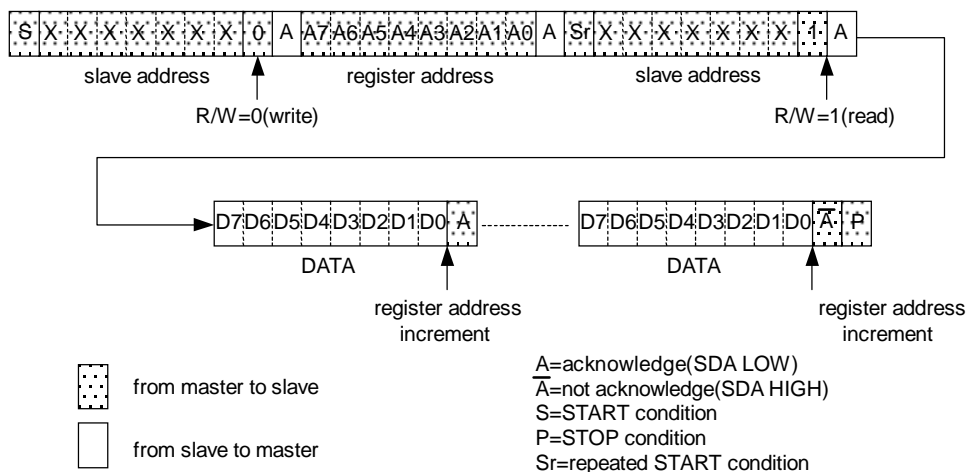

Figure 58. Multiple reading protocols

As for read protocol and multiple read protocol, please do \bar{A} (not acknowledge) after doing the final reading operation. It stops with read when ending by A(acknowledge), and SDA stops in the state of Low when the reading data of that time is 0. However, this state returns usually when SCL is moved, data is read, and \bar{A} (not acknowledge) is done.

(8) Timing diagram

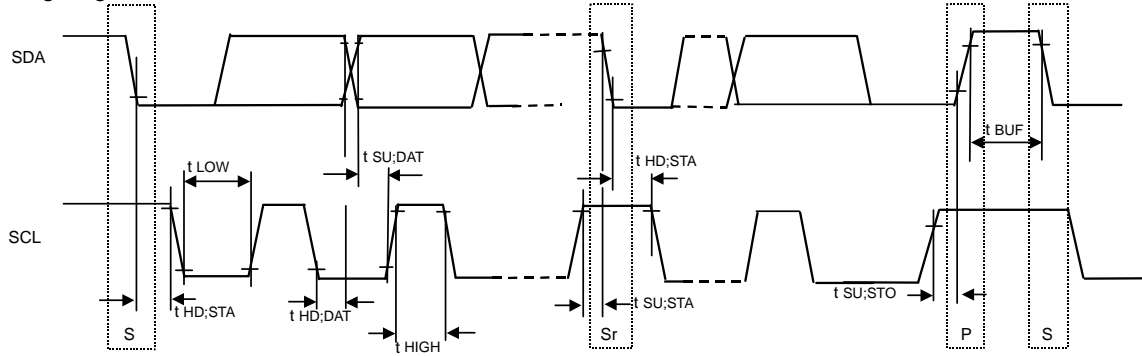

Figure 59. Timing Diagram (I²C format)

(9) Electrical Characteristics (Unless otherwise specified, Ta=25 °C, VBAT=3.6V, VIO=1.8V)

Table 2. Electrical Characteristics

Parameter	Symbol	Standard-mode			Fast-mode			Unit
		Min.	Typ.	Max.	Min.	Typ.	Max.	
[I²C BUS format]								
SCL clock frequency	f _{SCL}	0	-	100	0	-	400	kHz
LOW period of the SCL clock	t _{LOW}	4.7	-	-	1.3	-	-	μs
HIGH period of the SCL clock	t _{HIGH}	4.0	-	-	0.6	-	-	μs
Hold time (repeated) START condition After this period, the first clock is generated	t _{HD;STA}	4.0	-	-	0.6	-	-	μs
Set-up time for a repeated START condition	t _{SU;STA}	4.7	-	-	0.6	-	-	μs
Data hold time	t _{HD;DAT}	0	-	3.45	0	-	0.9	μs
Data set-up time	t _{SU;DAT}	250	-	-	100	-	-	ns
Set-up time for STOP condition	t _{SU;STO}	4.0	-	-	0.6	-	-	μs
Bus free time between a STOP and START condition	t _{BUF}	4.7	-	-	1.3	-	-	μs

● Register List

Table 3. Register List

Address	R/W	Initial	Register Data								Function	
			D7	D6	D5	D4	D3	D2	D1	D0		
00h	W	00h	-	-	-	-	-	-	-	-	SFRST	Software Reset
01h	R/W	01h	-	-	-	OVP(1)	OVP(0)	-	-	-	ROCP	Common Setting1
02h	R/W	02h	SKIPEN (1)	SKIPEN (0)	SWSRT (1)	SWSRT (0)	-	FOSC	FB(1)	FB(0)	-	Common Setting2
03h	R/W	05h	-	-	-	-	-	LED2 SEL	-	LED1 SEL	-	LED channel select
04h	R/W	00h	-	-	-	-	-	-	-	-	-	dummy1
05h	R/W	FFh	ILED(7)	ILED(6)	ILED(5)	ILED(4)	ILED(3)	ILED(2)	ILED(1)	ILED(0)	-	Current ratio Setting
06h	R/W	00h	-	-	-	-	-	-	-	-	-	dummy2
07h	R/W	06h	-	-	PWMEN	-	-	LPFEN	SHORT	-	-	Control Setting
08h	R/W	00h	-	-	-	-	-	SRCHG (2)	SRCHG (1)	SRCHG (0)	-	Slew Rate changing Setting
09h	R/W	00h	-	-	-	-	-	-	-	-	-	dummy3
0Ah	R/W	00h	-	-	-	-	-	-	-	-	-	dummy4
0Bh	R/W	00h	-	-	-	-	-	-	-	-	-	dummy5
0Ch	R/W	00h	-	-	-	-	-	-	-	-	-	dummy6
0Dh	R/W	00h	-	-	-	-	-	-	-	-	-	dummy7
0Eh	R/W	00h	-	-	-	-	-	-	-	-	PON	Enable Setting

Input "0" for "-".

A free address has the possibility to assign it to the register for the test.

Access to the register for the test and the undefined register is prohibited.

●Register Map

Address 00h < Software Reset >

Address	R/W	D7	D6	D5	D4	D3	D2	D1	D0
00h	W	-	-	-	-	-	-	-	SFRST
Initial Value	00h	-	-	-	-	-	-	-	0

D0: **SFRST** Software Reset
 0: Reset cancel
 1: Reset (Initializes all registers)

Address 01h < Common Setting1 >

Address	R/W	D7	D6	D5	D4	D3	D2	D1	D0
01h	R/W	-	-	-	OVP(1)	OVP(0)	-	-	ROCP
Initial Value	01h	0	0	0	0	0	0	0	1

D[4:3]: **OVP(1:0)** Over Voltage Protection Detect Voltage
 00b: 23.5V (Typ.) this setting is suitable for the parts of 25V Absolute Maximum Ratings (initial value)
 01b: 28.0V (Typ.) this setting is suitable for the parts of 30V Absolute Maximum Ratings
 10b: 31.0V (Typ.) this setting is suitable for the parts of 35V or 50V Absolute Maximum Ratings
 11b: 23.5V (Typ.) this setting is suitable for the parts of 25V Absolute Maximum Ratings

D0: **ROCP** Over Current Protection Level Setting
 0: 1.7A (Typ.)
 1: 1A (Typ.) (initial value)

Address 02h < Slew Rate, Fosc, Feedback voltage >

Address	R/W	D7	D6	D5	D4	D3	D2	D1	D0
02h	R/W	SKIPEN (1)	SKIPEN (0)	SWSRT (1)	SWSRT (0)	-	FOSC	FB(1)	FB(0)
Initial Value	02h	0	0	0	0	0	0	1	0

D[7:6]: **SKIPEN(1:0)** Pulse skip Setting
 00b: pulse skip all mode active (initial value)
 01b: pulse skip mode1 disable (Minimum duty fix mode)
 10b: pulse skip mode2 disable (pulse stop mode)
 11b: pulse skip all mode disable

Pulse skip all mode is Min duty fix mode and pulse stop mode.
 Pulse skip mode1 is Min duty fix mode.
 Pulse skip mode2 is pulse stop mode.

D[5:4]: **SWSRT(1:0)** Control the rise and fall time of slew rate for SW terminal
 00b: x1 (initial value)
 01b: x0.8 (design concept)
 10b: x0.6 (design concept)
 11b: x0.4 (design concept)

D2: **FOSC** Switching Frequency Value Setting
 0: 0.6MHz (initial value)
 1: 1.1MHz

D[1:0]: **FB(1:0)** Feedback voltage Setting
 00b: 0.5V
 01b: 0.4V
 10b: 0.3V (initial value)
 11b: 0.2V

Address 03h < LED channel select >

Address	R/W	D7	D6	D5	D4	D3	D2	D1	D0
03h	R/W	-	-	-	-	-	LED2 SEL	-	LED1 SEL
Initial Value	05h	0	0	0	0	0	1	0	1

D2: **LED2SEL** Selection of the current driver and the protection for LED2
 0: unused LED2
 1: used LED2 (initial value)

D0: **LED1SEL** Selection of the current driver and the protection for LED1
 0: unused LED1
 1: used LED1 (initial value)

When this address is selected to 00h, the selected current driver and protection turn off.

(Note:) Set this address before setting address 0Eh to 01h (Power on).
 Once setting ad0Eh to 01h, this address (LED channel select) is non-functional.

	Setting	LED1 channel	LED2 channel	Comment
Reset	RESET terminal "H" to "L" Software Reset (ad00h data=01h)	○	○	
Initial LED1 = used LED2 = used	ad03h data=05h	○	○	
LED1 = used LED2 = unused	ad03h data=01h	○	×	
Power on	ad0Eh data=01h	○	×	
LED1 = used LED2 = unused	ad03h data=04h	○	×	LED channel select is not changed
Power off	ad0Eh data=00h	○	×	
LED1 = unused LED2 = used	ad03h data=04h	×	○	LED channel select is changed.
Power on	ad0Eh data=01h	×	○	

○ : select

× : unselect

Address 05h < LED Current Ratio Setting >

Address	R/W	D7	D6	D5	D4	D3	D2	D1	D0
05h	R/W	ILED(7)	ILED(6)	ILED(5)	ILED(4)	ILED(3)	ILED(2)	ILED(1)	ILED(0)
Initial Value	FFh	1	1	1	1	1	1	1	1

D[7:0]: **ILEDx(7:0)** LED Current Setting

This address determines the ratio of the operating LED current with respect to the maximum LED current set by RSET. The ratio can be varied from 1/256 to 256/256.

data 00h → ratio = (0+1)/256 = 1/256 = 0.39%

data 20h → ratio = (32+1)/256 = 33/256 = 12.89%

data C7h → ratio = (199+1)/256 = 200/256 = 78.13%

data FFh → ratio = (255+1)/256 = 256/256 = 100%

LED current = max current x ratio x PWM duty (from PWM terminal)
 = IMAX x (ILED + 1) / 256 x PWM duty

Where:

IMAX is set by RSET, which is the resistor connected to ISET terminal (see LED Current Setting at P.34).

Address 07h <Control Setting>

Address	R/W	D7	D6	D5	D4	D3	D2	D1	D0
07h	R/W	-	-	PWMEN	-	-	LPFEN	SHORT	-
Initial Value	06h	0	0	0	0	0	1	1	0

D5: **PWMEN** PWM Enable Control (Valid/Invalid)
 0: PWM input is invalid, "H" fixed (initial value)
 1: PWM input is valid

PWMEN="1", LPFEN="0"

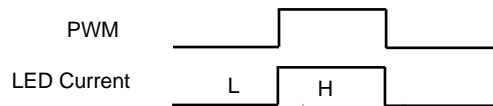

PWMEN="0", LPFEN="0"

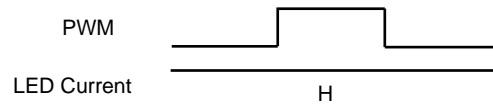

Figure 60. PWMEN setting

D2: **LPFEN** Low pass filter for Current Driver
 0: Low pass filter isn't used
 1: Low pass filter is used (initial value)

PWM dimming condition on PWMEN and LPFEN setting

PWMEN	LPFEN	LED Current
0	0	DC (8bit DAC)
0	1	DC (8bit DAC)
1	0	PWM (8bit DAC and PWM duty)
1	1	DC (8bit DAC and PWM duty)

D1: **SHORT** LED Short Protection Setting
 0: Short Protection is Invalid
 1: 5.4V (Initial value)

Address 08h <Slew Rate Change Setting>

Address	R/W	D7	D6	D5	D4	D3	D2	D1	D0
08h	R/W	-	-	-	-	-	SRCHG (2)	SRCHG (1)	SRCHG (0)
Initial Value	00h	0	0	0	0	0	0	0	0

D[2:0]: **SRCHG(2:0)** Slew Rate Change Setting
 000b: Keep the slew rate selected at ad02h D[5:4] (initial value)
 001b: Repeat x0.4→x0.6→x0.8→x1.0→x0.8→x0.6 →…
 010b: Repeat x0.4→x0.6→x0.8→x0.6→…
 011b: Repeat x0.4→x0.6→…
 100b: Repeat x0.8→x1.0→…
 101b,110b,111b: Repeat x0.6→x0.8→…

SWCHG(2:0)=000b

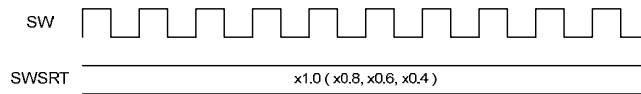

SWCHG(2:0)=001b

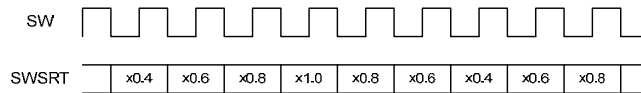

SWCHG(2:0)=010b

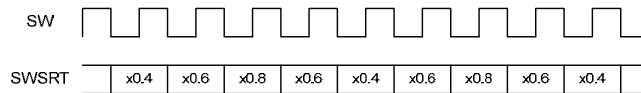

SWCHG(2:0)=011b

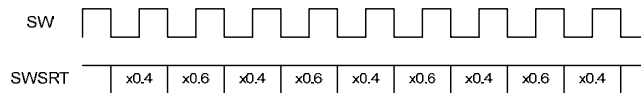

SWCHG(2:0)=100b

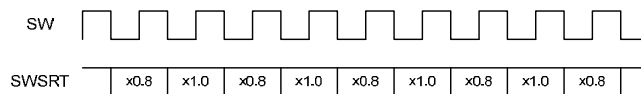

SWCHG(2:0)=101b, 110b, 111b

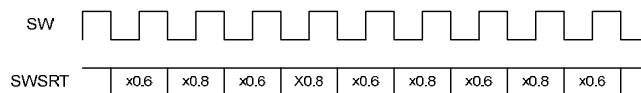

Address 0Eh <Enable Setting>

Address	R/W	D7	D6	D5	D4	D3	D2	D1	D0
0Eh	R/W	-	-	-	-	-	-	-	PON
Initial Value	00h	0	0	0	0	0	0	0	0

D0: **PON** Power control for all blocks
 0: Power off (initial value)
 1: Power on

●Functional Descriptions

1) Reset

There are two kinds of reset, software reset and hardware reset.

●Software reset

All the registers are initialized by SFTRST = "1".
SFTRST is an automatically returned to "0". (Auto Return 0)

●Hardware reset

It shifts to hardware reset by changing RESET pin "H" → "L".

The condition of all the registers under hardware reset pin is returned to the initial value, and it stops accepting all address.

To release from a state of hardware reset, change RESET pin "L" → "H".

●Reset Sequence

When hardware reset was done during software reset, software reset is canceled when hardware reset is canceled.
(Because the initial value of software reset is "0")

2) Pulse skip control

This IC regulates the output voltage using an improved pulse-skip. In "pulse-skip" mode, the error amplifier disables the oscillator causing the "switching" of the power stages to stop when low output voltage and high input voltage are detected. The said switching cycle will be reactivated when the IC detects low input voltage.

At light loads, a conventional "pulse-skip" regulation mode is used. The "pulse-skip" regulation minimizes the operating current because this IC does not switch continuously and hence the losses of the switching are reduced. When the error amplifier disables "switching", the load is also isolated from the input. This improved "pulse-skip" control is also referred to as active-cycle control.

Pulse skip setting can be controlled in four (4) different modes by register (SKIPEN:(ad02h D[7:6])).

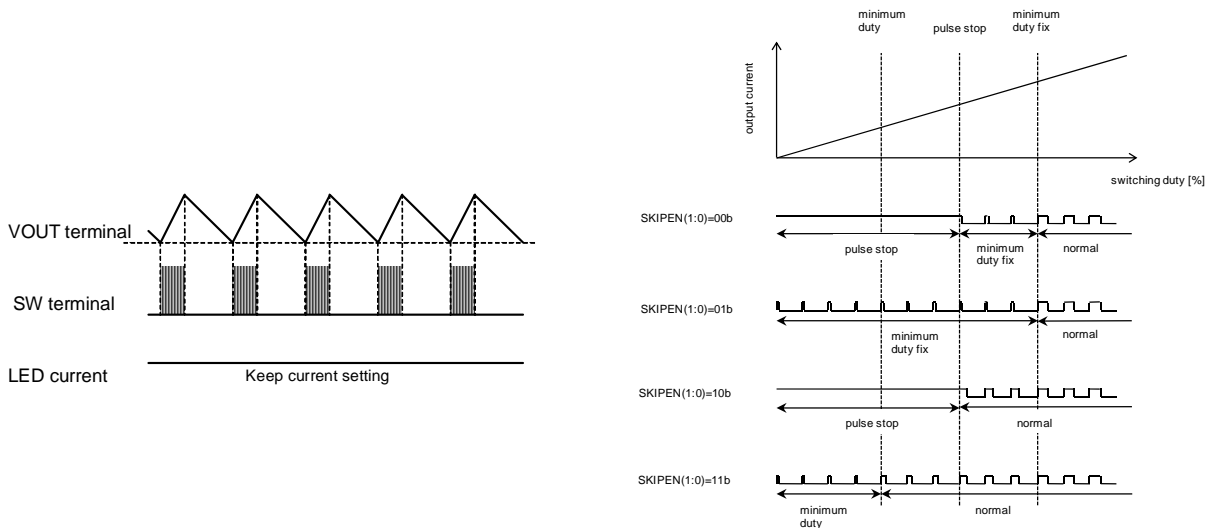

Figure 61. Pulse-skip

3) Soft start

BD65B60 has a soft start function which prevents large coil current from flowing to the IC. During start-up, in-rush current is prevented. The "soft start" of this IC controls the over-current setting hence peak current is controlled.

After changing Enable register (PON:(ad0Eh D0)) from "L" to "H", Soft start takes place within the period of 1.8ms (Typ.)

Once "soft start" is finished, boost condition change to normal state.

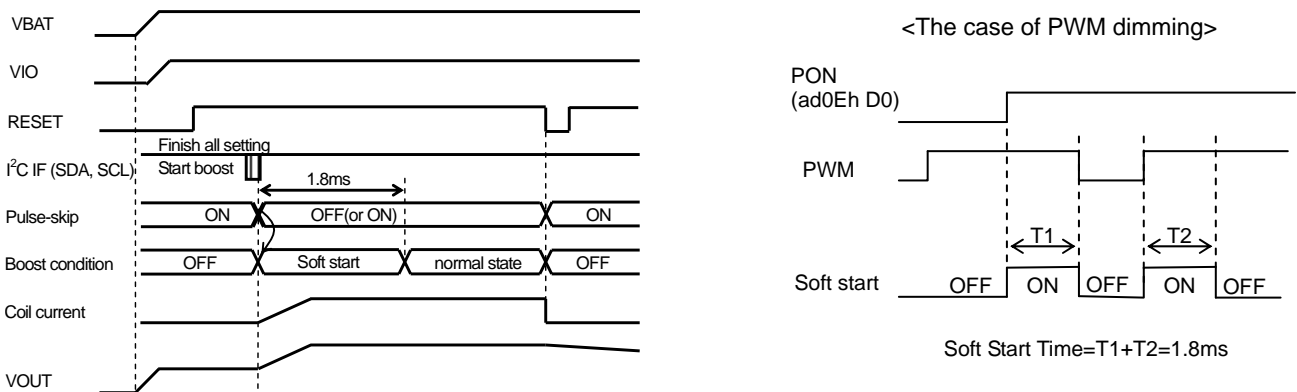

Figure 62. Soft start

●Protection

PROTECTION TABLE

No	Failure Mode	Detection Mode	LED current	DC/DC Feedback	DC/DC Action	After release Failure
1	LED1 is used LED2 is used LED Short (LED1 is Short)	LED1 > 5.4V(Typ.) LED2 < 0.9V(Typ.) VSC = 5.4V(Typ.)	<short LED> stop <other LED> Active	<short LED> Feedback cut <other LED> Feedback Active	Normal Output	Latch
2	LED1 is used LED2 is used LED Short (Both LED1 and LED2 are Short)	LED1 > 5.4V(Typ.) LED2 > 5.4V(Typ.) VSC = 5.4V(Typ.)	<short LED> Active	<short LED> Feedback Active	Normal Output	Auto return
3	LED1 is used LED2 is used LED Short (Both LED1 and LED2 are Short)	LED1 < 5.4V(Typ.) LED2 < 5.4V(Typ.) VSC = 5.4V(Typ.)	<short LED> Active	<short LED> Feedback Active	Normal Output	Auto return
4	LED1 is used LED2 is unused LED Short (LED1 is Short)	LED1 > 5.4V(Typ.) VSC = 5.4V(Typ.)	<short LED> Active	<short LED> Feedback Active	Normal Output	Auto return
5	LED1 is used LED2 is unused LED Short (LED1 is Short)	LED1 < 5.4V(Typ.) VSC = 5.4V(Typ.)	<short LED> Active	<short LED> Feedback Active	Normal Output	Auto return
6	LED OPEN (LED1 is Open)	VOUT > OVP setting LED2 < 5.4V(Typ.) VSC = 5.4V(Typ.)	<open LED> Don't flow <other LED> Active	<open LED> Feedback Active <other LED> Feedback Active	OVP action	Auto return
7	LED OPEN (LED1 is Open)	VOUT > OVP setting LED2 > 5.4V(Typ.) VSC = 5.4V(Typ.)	<open LED> Don't flow <other LED> Don't flow	<open LED> Feedback Active <other LED> Feedback Active	LED Short action	Latch
8	LED OPEN (Both LED1 and LED2 are Open)	VOUT > OVP setting	Don't flow	Active	OVP action	Auto return
9	VOUT/SW short to GND	VOUT < 0.2V	Don't flow	Active	Stop	Auto return
10	LED VF more than OVP setting	VOUT > OVP setting	Stop	Active	OVP action	Auto return
11	SW current too high	SW current > OCP	Active	Active	OCP action	Auto return
12		Temperature > TSD(175°C)	Stop	Active	Stop	Auto return

Condition: normal state (This state isn't "soft start")

The Latch is released by

- (1) Input hardware reset signal to RESET terminal
- (2) Input the register of software reset by I2C
- (3) detect UVLO

Please refer to "Application Deficiency Operation" regarding these functions.

▪ Over voltage protection (OVP)

When LED is disconnected, it will result to open DC/DC output causing it to over step-up. When VOUT pin exceeds the absolute maximum rating, the switch N-channel Transistor and IC will break down. To prevent this, the over-voltage limit is activated when VOUT pin becomes equal or more than the detect voltage thus turning off the switching and stopping the operation of the DC/DC.

After over voltage protection, as shown in Figure 63, the IC changes from active into non-active, and the output voltage goes down slowly.

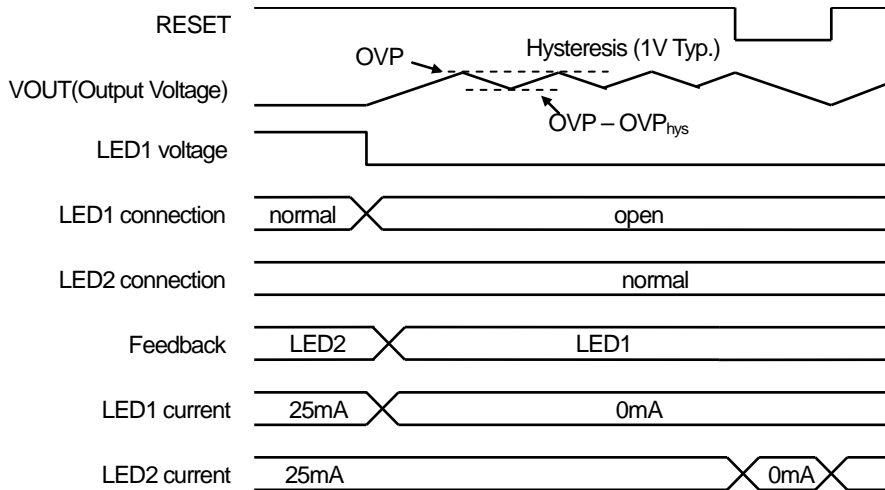

Figure 63. OVP operating description

▪ Over Current Protection

Over current flows in current detect resistor that is connected between internal switching Tr source and GND. When it increases beyond the detect voltage, over current protect operates. Over current protect prevents the increase of more than the detect voltage by reducing the “ON” Duty of switching Tr without stopping boosting operation. Since the over current detector of this IC detects peak current, over current does not flow more than the set value.

▪ External SBD open detect / Output Short protection

If in case external SBD and DC/DC output (VOUT) connections are opened or VOUT is shorted to GND, there is a risk that the coil and the internal Tr may be destroyed. External SBD open and output short protection activate when VOUT becomes 200mV(Typ.) or below causing the output Tr to turn off and preventing the destruction of the coil and the IC. No current will flow (0mA) since the IC changes from active into non-active.

▪ Thermal shut down

This IC has thermal shut down function. The thermal shut down works at 175°C (Typ.) or higher, and the IC changes from active into non-active.

▪ Low voltage detect protection (UVLO)

When supply voltage (VBAT) becomes lower than the detect voltage 2.1V(Typ.), DC/DC converter and constant current driver are disabled. Moreover, this function can be turned off by boosting supply voltage up to more than hysteresis voltage.

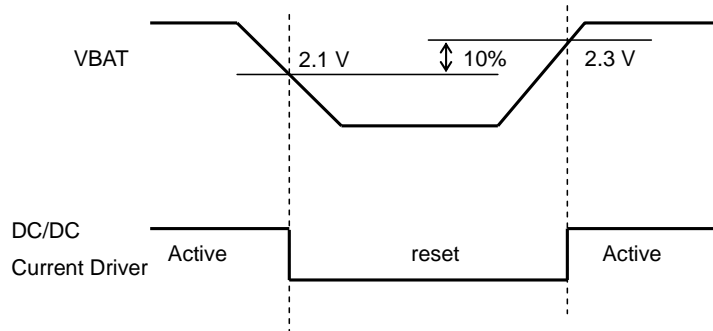

Figure 64. UVLO protection

● Application Deficiency Operation

(1) When 1 LED or 1string is OPEN during the operation

The LED string, which become OPEN will not light (e.g. LED1) but the other LED string will continue its operation. As shown in Figure 65, LED1 voltage becomes 0V when channel LED1 is opened. This voltage which is below 0.3V (Typ.) will then be detected as its lowest feedback voltage causing the output voltage to boost up to its over voltage protection limits.

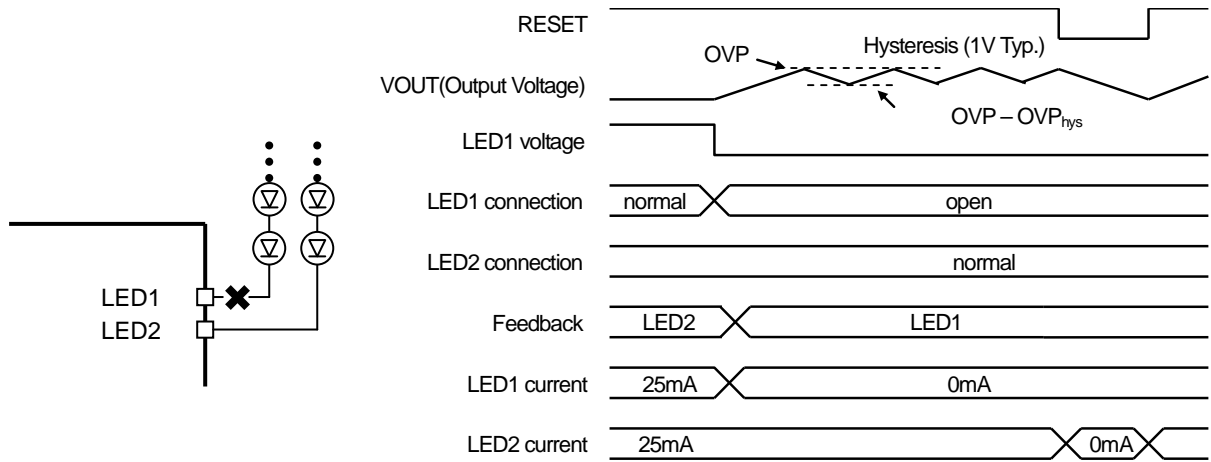

Figure 65. LED open protect

(2) When LED short-circuited in multiple

All LED strings are lighted unless LED1 and LED2 terminal voltage is more than 5.4V(Typ.)(SHORT:(ad02h D0)=1). Only the string that is short-circuited becomes more than 5.4V(Typ.) will be turned off while the other LED string continues to turn on normally. As shown in Figure 66, LED1 current (Shorted line) is changed from 25mA(Typ.) to 0mA(Typ.), so LED1 terminal doesn't generate heat.

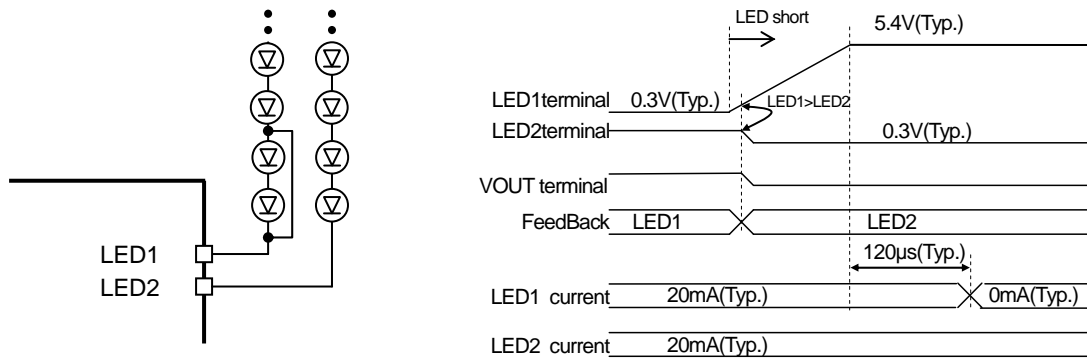

Figure 66. LED short protect

(3) When Schottky diode (SBD) remove

In the situation where the SBD connection is opened while DC/DC is still activated, SW terminal voltage becomes more than the rated voltage due to lack of parts that can accept the current accumulated inside the coil. Consequently, IC might be destroyed. To prevent the IC destruction, SBD open protection is operated. The SW terminal will not be damaged because boost operation will be stopped when VOUT terminal detects less than 0.2V.

●Selecting the Number of Operational LED Channels

The number of operational LED channels is chosen by modifying D2 and D0 of the register address 03h.

In the example as shown in Figure67, only LED1 channel is active (ad03h, data=01h).

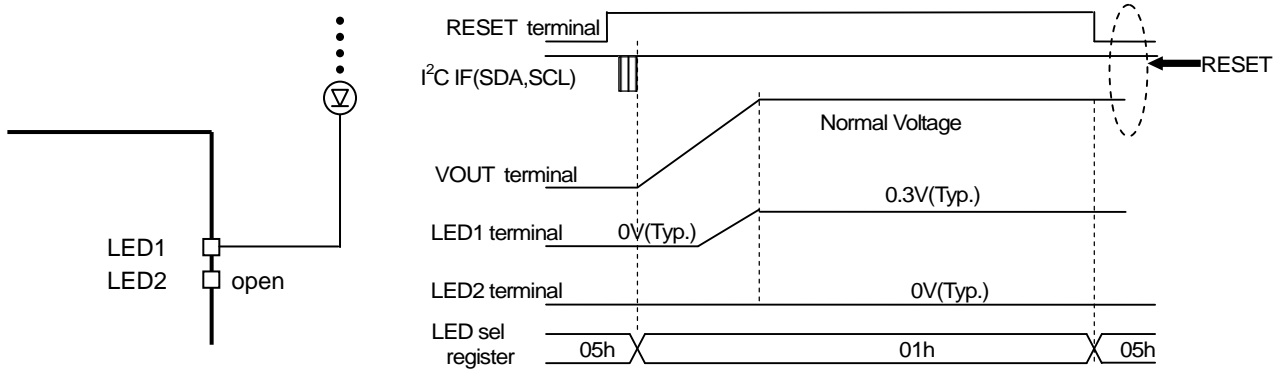

Figure 67. LED selection register is set for open strings

●LED Current Setting

LED current is set by register (ad05h D[7:0]) and RSET resistor which is computed in the following equation:

$$\begin{aligned} \text{LED current} &= \text{max current} \times \text{ratio} \times \text{PWM duty (from PWM terminal)} \\ &= \text{IMAX} \times (\text{ILED} + 1) / 256 \times \text{PWM duty} \end{aligned}$$

Where:

IMAX = this is set by the resistor (RSET) connected to ISET terminal and computed in the following equation:

$$\text{IMAX current} = 600 / \text{RSET (A)}$$

IMAX setting example

RSET	IMAX
24kΩ	25.0mA
30kΩ	20.0mA
56kΩ	10.7mA
120kΩ	5.0mA

ratio = this is given by varying ad05h D[7:0]

data 00h	→	ratio =	(0+1)/256 =	1/256 =	0.39%
data 20h	→	ratio =	(32+1)/256 =	33/256 =	12.89%
data C7h	→	ratio =	(199+1)/256 =	200/256 =	78.13%
data FFh	→	ratio =	(255+1)/256 =	256/256 =	100.00%

PWM duty = PWM “H” duty of PWM pulse. PWM pulse is inputted from PWM terminal.

●Feedback Voltage Setting

Feedback voltage is set by register (ad02h D[1:0]). To improve the efficiency, low feedback voltage which is determined by the LED current and output voltage (VOUT) ripple should be set.

To maintain a VOUT ripple below 50mV, the recommended feedback voltages for each LED current range are shown below:

Feedback voltage

Feedback voltage	IMAX
0.5V	All range
0.4V	Under 23.0mA
0.3V	Under 15.3mA
0.2V	Under 7.6mA

●Brightness Control

This IC has several methods of brightness controls such as: maximum current set by RSET resistor connected at ISET terminal; current ratio set by 8bit DAC and PWM control which can be set as DC or pulse input.

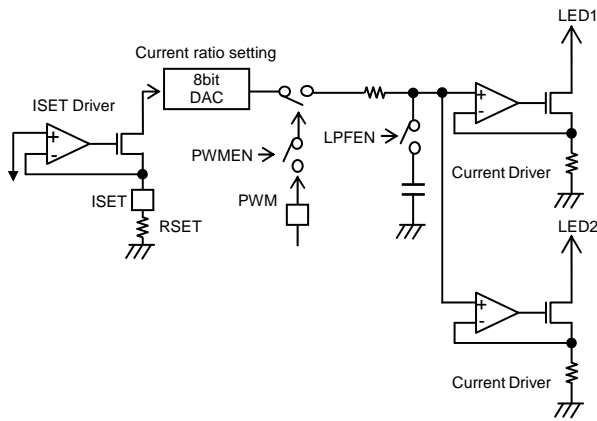

Figure 68. Brightness control

No.	PWMEN	LPFEN	LED Current
(1)	0	0	DC (8bit DAC)
	0	1	DC (8bit DAC)
(2)	1	0	PWM (8bit DAC and PWM duty)
(3)	1	1	DC (8bit DAC and PWM duty)

When PWMEN="1" by (ad07h D5), PWM pulse can be inputted and vice versa when PWMEN = "0".
 When LPFEN="0" by (ad07h D2), the capacitor of LPF is disconnected. LED current is as same as PWM pulse.
 When LPFEN="1", the capacitor of LPF is connected. LED current becomes DC.

(1)DC Dimming controlled by 8bit current DAC, as shown in Figure 68.

This dimming is controlled by 8bit current DAC controlled by current ratio register (ad05h). The LED current becomes DC, because PWM input is not accepted by PWMEN="0". Setting current is shown as below.

$$\begin{aligned} \text{LED current} &= \text{max. current} \times \text{ratio} \\ &= I_{\text{MAX}} \times (I_{\text{LED}} + 1) / 256 \end{aligned}$$

(2)PWM Dimming controlled by 8bit current DAC and PWM duty for CABC, as shown in Figure 70.

This dimming is controlled by 8bit current DAC and PWM pulse inputted to PWM terminal. Main brightness is controlled by 8bit current DAC and the dimming according to contents like movie and picture is controlled by PWM. LED current flows with the H section of PWM, and does not flow with the L section. Therefore, the average LED current increases in proportion to duty cycle of PWM signal. Because it becomes to switch the driver, the current tolerance is low when the PWM brightness is adjusted making it possible to control the brightness until 5μs (Min.10% at 20kHz). And, do not use for the brightness control, because effect of ISET changeover is big under 5μs ON time and under 5μs OFF time.

Setting current is shown as below.

$$\begin{aligned} \text{LED current} &= \text{max. current} \times \text{ratio} \times \text{PWM duty (from PWM terminal)} \\ &= I_{\text{MAX}} \times (I_{\text{LED}} + 1) / 256 \times \text{PWM duty} \end{aligned}$$

(3)DC Dimming controlled by 8bit current DAC and PWM duty for CABC, as shown in Figure 69.

This dimming is controlled by 8bit current DAC and PWM pulse inputted to PWM terminal. Main brightness is controlled by 8bit current DAC and the dimming according to contents like movie and picture is controlled by PWM. By LPF, PWM pulse becomes average into BD65B60, according to the duty of PWM pulse. Therefore, the average LED current increases in proportion to duty cycle of PWM signal. Because LED current becomes DC, coil current also becomes DC. The noise of this dimming is smaller than that of PWM dimming, but the current tolerance is worse than PWM dimming. PWM dimming range is from 10% to 100%. If duty changes under 10%, LED current tolerance become big. Typical PWM frequency is 20kHz to 100kHz.

Setting current is shown as below.

$$\begin{aligned} \text{LED current} &= \text{max. current} \times \text{ratio} \times \text{PWM duty (from PWM terminal)} \\ &= I_{\text{MAX}} \times (I_{\text{LED}} + 1) / 256 \times \text{PWM duty} \end{aligned}$$

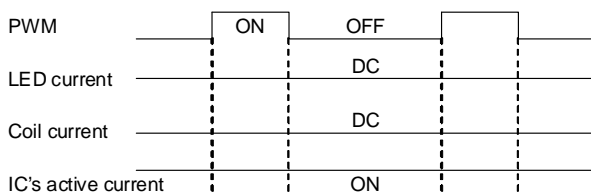

Figure 69. DC dimming

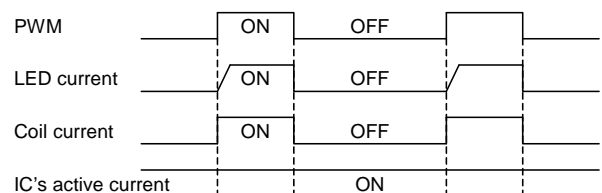

Figure 70. PWM dimming

●Coil Selection

The DC/DC is designed using a coil value equal or greater than 4.7μH. Sub-harmonic oscillation of current mode DC / DC might happen if the coil "L" value used is equal or lower than 2.2μH.

When the coil "L" value increases, the phase margin of DC / DC becomes zero therefore, output capacitor value should also be increased. Make the resistor component smaller in order to increase the efficiency of DCR Inductor. Estimation of Coil Peak Current is shown at the examples below.

Peak Current calculation

<Estimate of the current value which is needed for the normal operation>

As over current detector of this IC is detected the peak current, it have to estimate peak current to flow to the coil by operating condition.

- | | | |
|-------------|---|--|
| In case of, | - Supply voltage of coil = VIN | - Inductance value of coil = L |
| | - Switching frequency = fsw | - Output voltage = VOUT |
| | - Total LED current = ILED | |
| | - Average current of coil = Iave | - Peak current of coil = Ipeak |
| | - Cycle of Switching = T | - Efficiency = eff (Please set up having margin) |
| | - ON time of switching transistor = Ton | - ON Duty = D |

The relation is shown below:

$$\text{CCM: } I_{\text{peak}} = (V_{\text{IN}} / L) \times (1 / f_{\text{sw}}) \times (1 - (V_{\text{IN}} / V_{\text{OUT}})), \text{ DCM: } I_{\text{peak}} = (V_{\text{IN}} / L) \times T_{\text{on}}$$

$$I_{\text{ave}} = (V_{\text{OUT}} \times I_{\text{OUT}} / V_{\text{IN}}) / \text{eff}$$

$$T_{\text{on}} = (I_{\text{ave}} \times (1 - V_{\text{IN}} / V_{\text{OUT}}) \times (1 / f_{\text{sw}}) \times (L / V_{\text{IN}}) \times 2)^{1/2}$$

Each current is calculated.

As peak current varies according to whether there is the direct current superposed, the next is decided.

$$\text{CCM: } (1 - V_{\text{IN}} / V_{\text{OUT}}) \times (1 / f_{\text{sw}}) < T_{\text{on}} \rightarrow \text{peak current} = I_{\text{peak}} / 2 + I_{\text{ave}}$$

$$\text{DCM: } (1 - V_{\text{IN}} / V_{\text{OUT}}) \times (1 / f_{\text{sw}}) > T_{\text{on}} \rightarrow \text{peak current} = V_{\text{IN}} / L \times T_{\text{on}}$$

(Example 1)

In case of, VIN=3.6V, L=10μH, fsw=0.6MHz, VOUT=26.4V, ILED=50mA, Efficiency=88%

$$I_{\text{ave}} = (26.4\text{V} \times 50\text{mA} / 3.6\text{V}) / 88\% = 0.4167\text{A}$$

$$T_{\text{on}} = (0.4167\text{A} \times (1 - 3.6\text{V} / 26.4\text{V}) \times (1 / 0.6\text{MHz}) \times (10\mu\text{H} / 3.6\text{V}) \times 2)^{1/2} = 1.825\mu\text{s}$$

$$(1 - V_{\text{IN}} / V_{\text{OUT}}) \times (1 / f_{\text{sw}}) = 1.439\mu\text{s} < T_{\text{on}}(1.825\mu\text{s}) \quad \text{CCM}$$

$$I_{\text{peak}} = (3.6\text{V} / 10\mu\text{H}) \times (1 / 0.6\text{MHz}) \times (1 - (3.6\text{V} / 26.4\text{V})) = 0.5182\text{A}$$

$$\text{Peak current} = 0.5182\text{A} / 2 + 0.4167\text{A} = 0.6758\text{A}$$

(Example 2)

In case of, VIN=3.6V, L=10μH, fsw=0.6MHz, VOUT=19.8V, ILED=11.3mA, Efficiency=88%

$$I_{\text{ave}} = (19.8\text{V} \times 11.3\text{mA} / 3.6\text{V}) / 88\% = 0.0706\text{A}$$

$$T_{\text{on}} = (0.0706\text{A} \times (1 - 3.6\text{V} / 19.8\text{V}) \times (1 / 0.6\text{MHz}) \times (10\mu\text{H} / 3.6\text{V}) \times 2)^{1/2} = 0.731\mu\text{s}$$

$$(1 - V_{\text{IN}} / V_{\text{OUT}}) \times (1 / f_{\text{sw}}) = 1.364\mu\text{s} > T_{\text{on}}(0.731\mu\text{s}) \quad \text{DCM}$$

$$I_{\text{peak}} = V_{\text{IN}} / L \times T_{\text{on}} = 3.6\text{V} / 10\mu\text{H} \times 0.731\mu\text{s} = 0.2633\text{A}$$

$$\text{Peak current} = 0.2633\text{A}$$

DCM/CCM calculation

Discontinuous Condition Mode (DCM) and Continuous Condition Mode (CCM) are calculated as following.

$$\text{CCM: } L > V_{\text{OUT}} \times D \times (1 - D)^2 \times T / (2 \times I_{\text{LED}})$$

$$\text{DCM: } L < V_{\text{OUT}} \times D \times (1 - D)^2 \times T / (2 \times I_{\text{LED}})$$

$$*D = 1 - V_{\text{IN}} / V_{\text{OUT}}$$

(Example 1)

In case of, VIN=3.6V, L=10μH, fsw=0.6MHz, VOUT=26.4V, ILED=50mA

$$V_{\text{OUT}} \times D \times (1 - D)^2 \times T / (2 \times I_{\text{LED}})$$

$$= 26.4\text{V} \times (1 - 3.6\text{V} / 26.4\text{V}) \times (3.6\text{V} / 26.4\text{V})^2 \times 1 / (0.6 \times 10^6 \text{Hz}) / (2 \times 0.05\text{A}) = 7.066\mu\text{H} < L(10\mu\text{H})$$

→ CCM

(Example 2)

In case of, VIN=3.6V, L=10μH, fsw=0.6MHz, VOUT=19.8V, ILED=11.3mA

$$V_{\text{OUT}} \times D \times (1 - D)^2 \times T / (2 \times I_{\text{LED}})$$

$$= 19.8\text{V} \times (1 - 3.6\text{V} / 19.8\text{V}) \times (3.6\text{V} / 19.8\text{V})^2 \times 1 / (0.6 \times 10^6 \text{Hz}) / (2 \times 0.0113\text{A}) = 39.494\mu\text{H} > L(10\mu\text{H})$$

→ DCM

●OUTPUT Capacitor Selection

Output Capacitor smoothly keeps output voltage and supplies LED current. Output Voltage consists of Charge (FET ON) and Discharge (LED current). So Output voltage has Output ripple Voltage in every FET switching. Select a capacitor value which allows the output ripple voltage to settle within 50mV. Output ripple voltage is calculated as follows.

Output ripple Voltage

- Switching cycle = T
- Switching ON duty = D
- Output Capacitor = C_{OUT}
- Decreasing ratio of Capacitor = C_{error}
- Total LED current = I_{LED}
- Output ripple Voltage = V_{ripple}
- Output Capacitor (real value) = C_{real}
- Supply voltage of coil = V_{IN}

$$C_{real} = C_{OUT} \times C_{error} \quad (\text{Capacitor value is decreased by Bias})$$

$$C_{real} = I_{LED} \times (1-D) \times T / V_{ripple}$$

$$C_{OUT} = I_{LED} \times (1-D) \times T / V_{ripple} / C_{error}$$

(Example 1)

In case of, V_{IN}=3.6V, f_{sw}=0.6MHz, V_{OUT}=19.8V, I_{LED}=15mA, C_{OUT}=1.0μF, C_{error}=50%

$$T = 1 / 0.6\text{MHz}$$

$$D = 1 - V_{IN} / V_{OUT} = 1 - 3.6\text{V} / 19.8\text{V} = 0.818$$

$$\begin{aligned} V_{ripple} &= I_{LED} \times (1-D) \times T / (C_{OUT} \times C_{error}) \\ &= 15\text{mA} \times (3.6\text{V} / 19.8\text{V}) \times (1 / 0.6\text{MHz}) / (1.0\mu\text{F} \times 0.5) \\ &= 9.1\text{mV} \end{aligned}$$

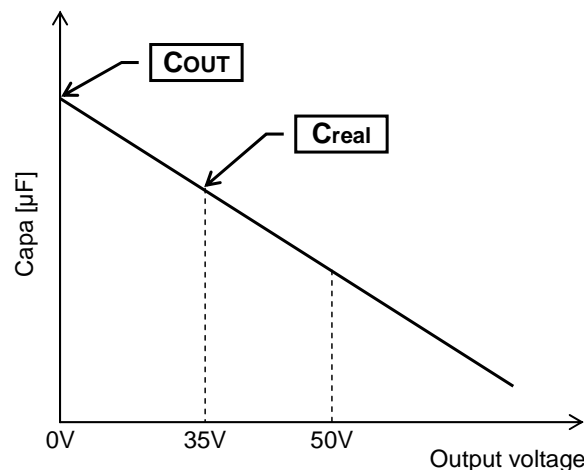

Figure 71. Bias Characteristics of Capacitor

●INPUT Capacitor Selection

1μF ceramic capacitor with 10V (greater than coil voltage) is recommended for the Inductor.

●Schottky Diode Selection

Schottky diode should be used for boost. Maximum peak current should be greater than inductor peak current (1A(Typ.) or 1.7A(Typ.)) to ensure reliable operation. Average current should be greater than the maximum output current. Schottky diodes with a low forward drop and fast switching speeds are ideal for increasing efficiency in portable applications. Choose a reverse break down voltage of the Schottky diode significantly larger than the output voltage.

●LED Selection

Please select LED V_F that input voltage is smaller than output voltage (V_{OUT}). And also select LED V_F that output voltage is smaller than OVP voltage -1V.

●SDA, SCL Pull-up Resistor Selection

Please select the most suitable Pull-up resistor value to input I²C frequency. The case Pull-up resistor value is too big, SCL and SDA pulse are rounded. Therefore high speed transfer is impossible.

● IC and Coil Power Supply Separation

BD65B60 can operate in a separate power source for the IC and coil. With this application, IC power consumption is decreased and the applied voltage can be exceeded the IC rating of 5.5V.

Figure 72 shows the separate power sources for coil and IC wherein the coil power supply is connected to a high voltage source applied from adapters.

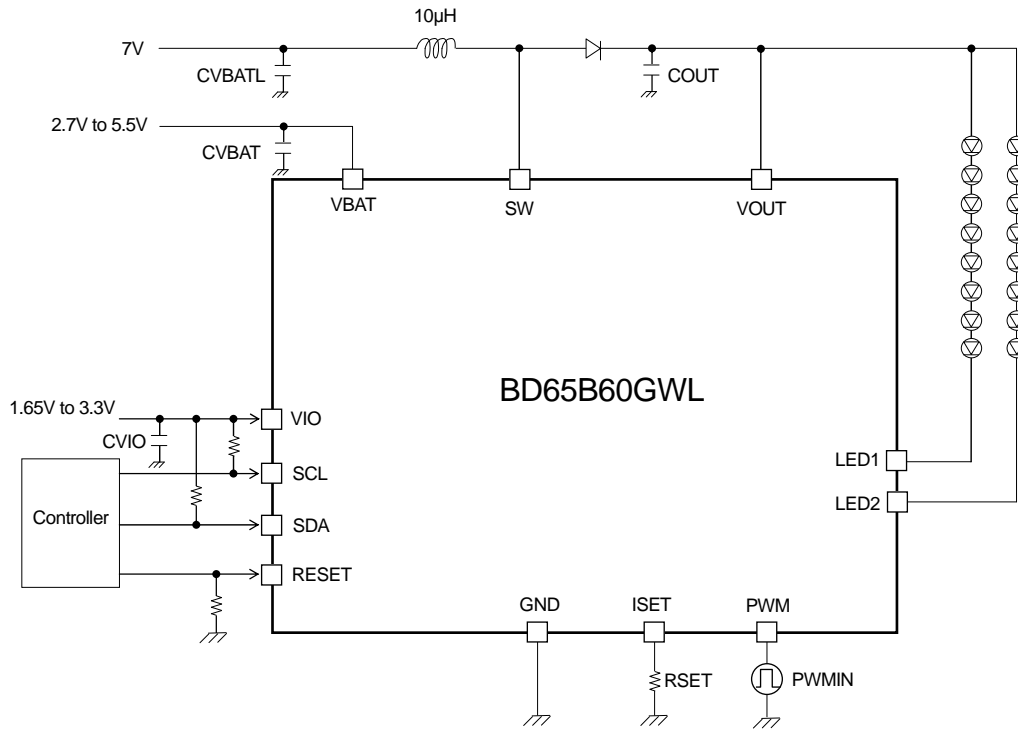

Figure 72. Separate Power Supply Application

●PCB Layout

PCB layout is very important to achieve the best performance of the IC. Layout pattern can greatly affect some characteristics of the IC, such as efficiency and ripple.

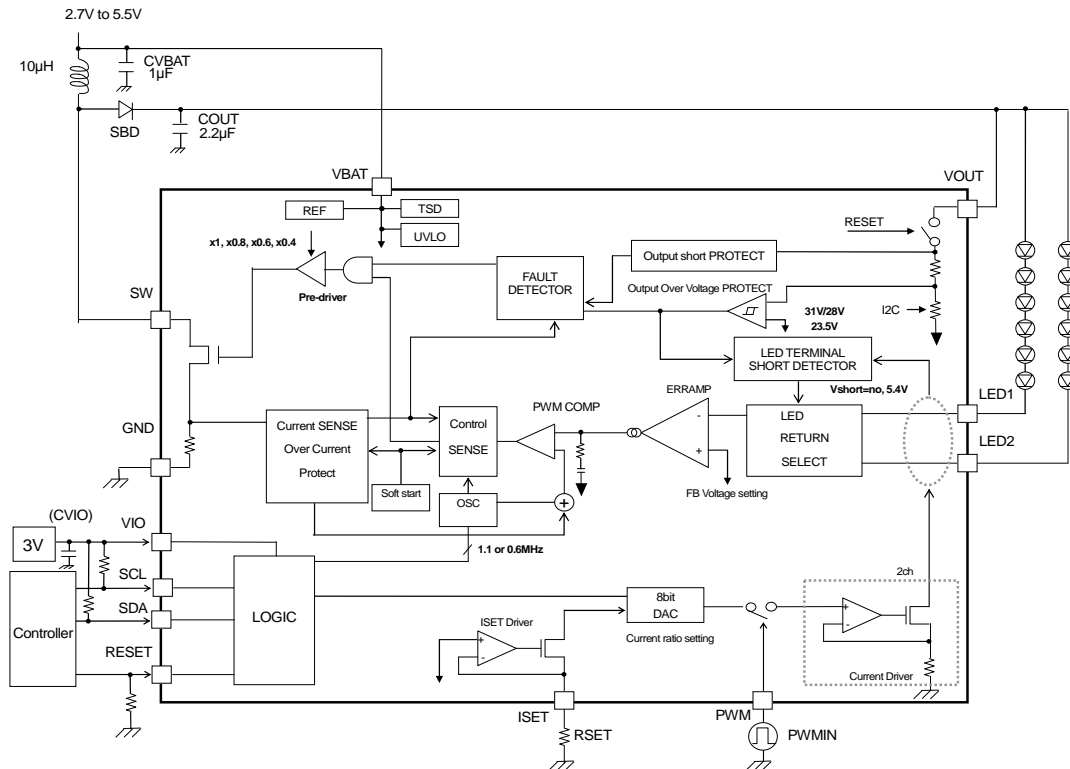

Figure 73. Schematic

<Input bypass capacitor CVBAT (1.0µF(Typ.))>

Connect input bypass capacitor CVBAT (1.0µF(Typ.)) as close as possible to coil and GND pin.

<Input bypass capacitor CVIO (0.1µF(Typ.))>

Connect input bypass capacitor CVIO (0.1µF(Typ.)) as close as possible to VIO pin and GND pin.

<Coil>

Connect coil as close as possible to SW pin. When the distance between coil and SW pin is long, the efficiency becomes incorrect due to the effect of PCB parasitic capacitance.

<Schottky barrier diode SBD>

Connect Schottky barrier diode SBD as close as possible between coil and SW pin.

<Output capacitor COUT>

Connect output capacitor COUT between cathode of SBD and GND.
Make both GND sides of CVBAT and COUT as close as possible.

<Others>

Connect the current setting resistor RSET near the ISET and GND pins. When these pins are not directly connected near the chip, the performance of BD65B60 may be affected and it may limit the current drive. As for the wire of the inductor, make sure that its resistance is small enough to reduce the electric power consumption and to increase the entire efficiency.

Do not connect capacitor between ISET and GND pin.

● Recommended Layout Pattern

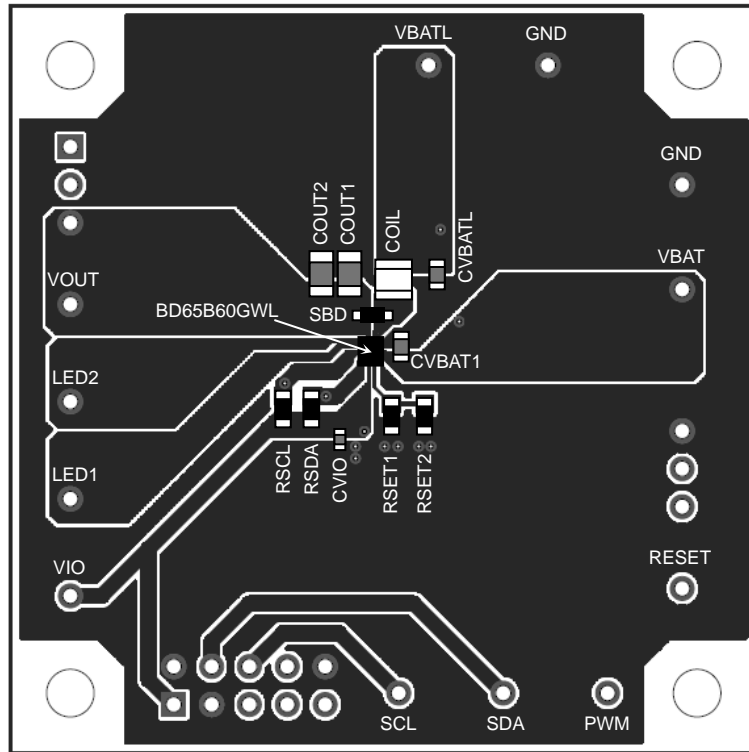

Figure 74. Top Copper trace layer

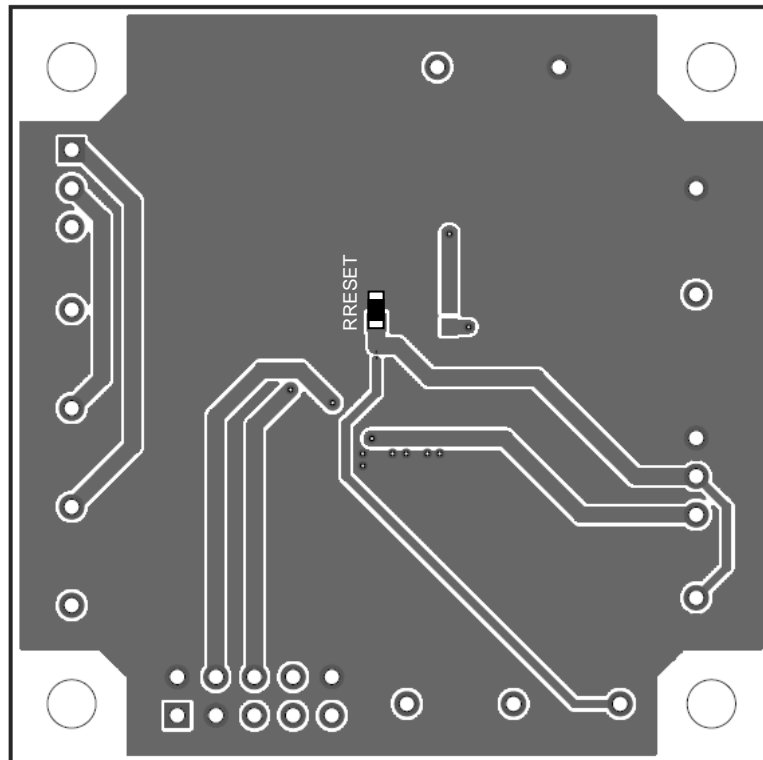

Figure 75. Bottom Copper trace layer

● Selection of External Parts

Recommended external parts are shown below.

If there are parts that will be used and not listed below, make sure to choose the equivalent parts.

•Coil

Value	Manufacturer	Product number	Size (mm)			DC current (mA)	DCR (Ω)
			Vertical	Horizontal	Height (MAX)		
10μH	TDK	VLF302512MT-100M	3.0	2.5	1.2	690	0.25
10μH	TDK	VLF403212MT-100M	4.0	3.2	1.2	1000	0.23
10μH	TDK	VLF302510MT-100M	3.0	2.5	1.0	650	0.31
10μH	TDK	VLF403210MT-100M	4.0	3.2	1.0	780	0.26
10μH	TOKO	DEM3532C series 1229AS-H-100M	3.5	3.7	1.2	750	0.24
4.7μH	TOKO	DFE322512C series 1277AS-H-4R7M	3.2	2.5	1.2	1800	0.17
4.7μH	TOKO	DFE252012C series 1239AS-H-4R7M	2.5	2.0	1.2	1500	0.24
10μH	TOKO	DFE252012C series 1239AS-H-100M	2.5	2.0	1.2	1000	0.46
4.7μH	TOKO	DFE322510C series 1276AS-H-4R7M	3.2	2.5	1.0	1400	0.22
10μH	TOKO	DFE322510C series 1276AS-H-100M	3.2	2.5	1.0	900	0.49

•Capacitor

Value	Pressure	Manufacturer	Product number	Size (mm)		
				Vertical	Horizontal	Height
2.2μF	50V	MURATA	GRM31CB31H225K	3.2	1.6	1.6
1.0μF	50V	MURATA	GRM31MB31H105K	3.2	1.6	1.15
1.0μF	50V	MURATA	GRM188B31H105K	1.6	0.8	0.8
4.7μF	25V	MURATA	GRM319R61E475K	3.2	1.6	0.85
2.2μF	25V	MURATA	GRM219B31E225K	2.0	1.25	0.85
1.0μF	25V	MURATA	GRM188B31E105K	1.6	0.8	0.8
4.7μF	10V	MURATA	GRM219B31A475K	2.0	1.25	0.85
2.2μF	10V	MURATA	GRM188B31A225K	1.6	0.8	0.8
1.0μF	10V	MURATA	GRM188B11A105K	1.6	0.8	0.8

•SBD

Pressure	Manufacturer	Product number	Size (mm)			I _o	recommended the number of LEDs
			Vertical	Horizontal	Height		
30V	ROHM	RB521SM-30	1.6	0.8	0.6	0.2A	7series 1string
30V	ROHM	RB550SS-30	1.6	0.8	0.6	0.5A	7series 2strings
30V	ROHM	RB550VA-30	2.5	1.3	0.6	1.0A	7series 2strings
40V	ROHM	RB521SM-40	1.6	0.8	0.6	0.2A	8series 1string
40V	ROHM	RB160SS-40	1.6	0.8	0.6	1.0A	8series 2strings
40V	ROHM	RB160VA-40	2.5	1.3	0.6	1.0A	8series 2strings

The coil is the most influential part to efficiency. Select a coil which has an excellent direct current resistor (DCR) and current-inductance characteristic. BD65B60 IC is designed for an inductance value of 4.7μH to 10μH. Do not use inductance values less than 2.2μH. Select a ceramic capacitor type with excellent frequency and temperature characteristics.

Furthermore, select a capacitor with small direct current resistance and pay sufficient attention to the layout pattern.

● Application Example

Figure 76 and Figure 77 are Application examples.

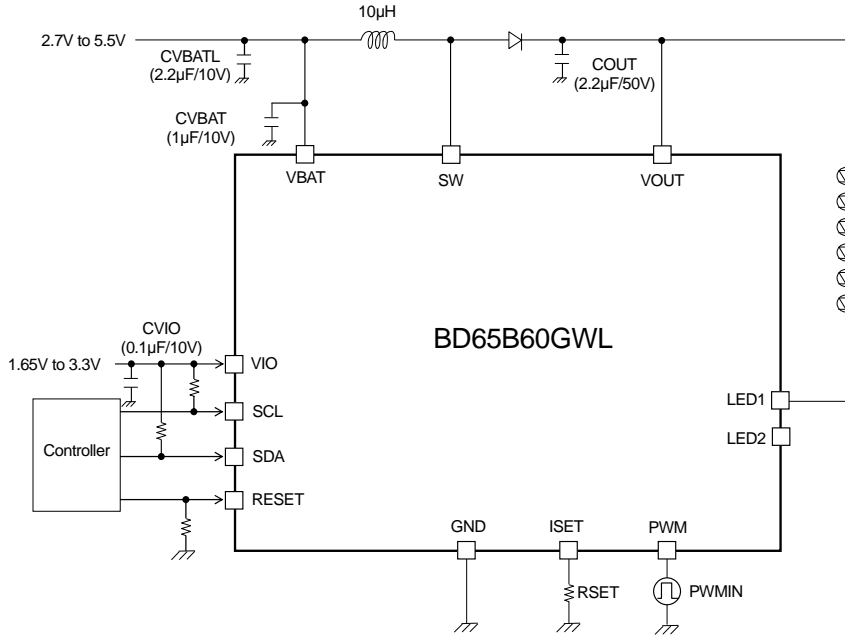

Figure 76. Application example (6 series x 1 string)

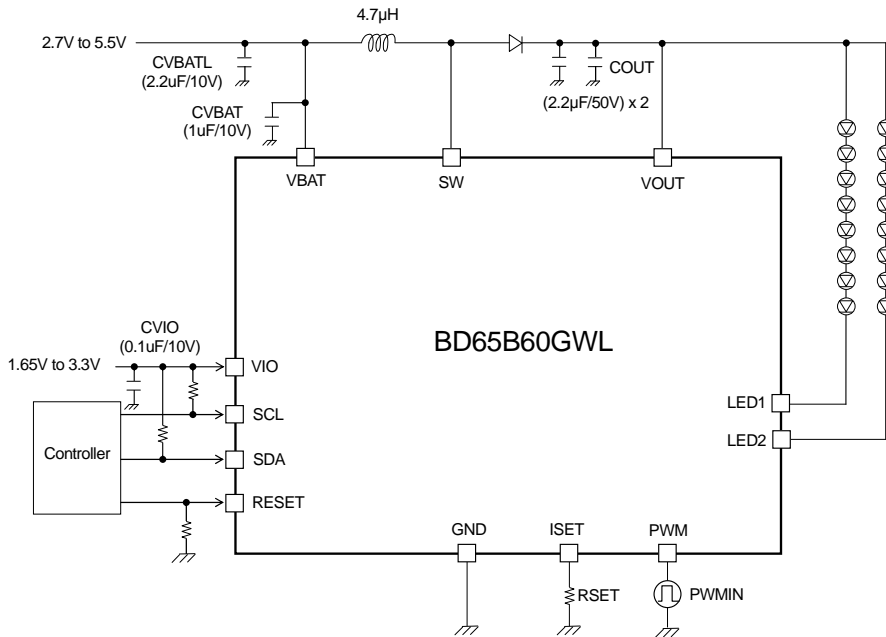

Figure 77. Application example (8 series x 2 strings)

●Attention Point of Board Layout

In board pattern design, power supply line should be low Impedance, especially around DC/DC converter. Insert a bypass capacitor if necessary.

●About Heat Loss

In heat design, operate the DC/DC converter in the following condition.
(The following temperature is a guarantee temperature, so consider the margin.)

1. Ambient temperature T_a must be less than 85°C.
2. The loss of IC must be less than dissipation P_d .

●Cautions on use**(1) Absolute Maximum Ratings**

An excess in the absolute maximum ratings, such as supply voltage (VBAT), temperature range of operating conditions (Topr), etc., can break down devices, thus making impossible to identify breaking mode such as a short circuit or an open circuit. If any special mode exceeding the absolute maximum ratings is assumed, consideration should be given to take physical safety measures including the use of fuses, etc.

(2) Operating conditions

These conditions represent a range within which characteristics can be provided approximately as expected. The electrical characteristics are guaranteed under the conditions of each parameter.

(3) Reverse connection of power supply connector

The reverse connection of power supply connector can break down ICs. Take protective measures against the breakdown due to the reverse connection, such as mounting an external diode between the power supply and the IC's power supply terminal.

(4) Power supply line

Design PCB pattern to provide low impedance for the wiring between the power supply and the GND lines. Furthermore, for all power supply terminals to ICs, mount a capacitor between the power supply and the GND terminal. At the same time, in order to use an electrolytic capacitor, thoroughly check to be sure the characteristics of the capacitor to be used present no problem including the occurrence of capacity dropout at a low temperature, thus determining the constant.

(5) GND voltage

Make setting of the potential of the GND terminal so that it will be maintained at the minimum in any operating state. Furthermore, check to be sure no terminals are at a potential lower than the GND voltage including an actual electric transient.

(6) Short circuit between terminals and erroneous mounting

In order to mount ICs on a set PCB, pay thorough attention to the direction and offset of the ICs. Erroneous mounting can break down the ICs. Furthermore, if a short circuit occurs due to foreign matters entering between terminals or between the terminal and the power supply or the GND terminal, the ICs can break down.

(7) Operation in strong electromagnetic field

Be noted that using ICs in the strong electromagnetic field can malfunction them.

(8) Inspection with set PCB

On the inspection with the set PCB, if a capacitor is connected to a low-impedance IC terminal, the IC can suffer stress. Therefore, be sure to discharge from the set PCB by each process. Furthermore, in order to mount or dismount the set PCB to/from the jig for the inspection process, be sure to turn OFF the power supply and then mount the set PCB to the jig. After the completion of the inspection, be sure to turn OFF the power supply and then dismount it from the jig. In addition, for protection against static electricity, establish a ground for the assembly process and pay thorough attention to the transportation and the storage of the set PCB.

(9) Input terminals

In terms of the construction of IC, parasitic elements are inevitably formed in relation to potential. The operation of the parasitic element can cause interference with circuit operation, thus resulting in a malfunction and then breakdown of the input terminal. Therefore, pay thorough attention not to handle the input terminals, such as to apply to the input terminals a voltage lower than the GND respectively, so that any parasitic element will operate. Furthermore, do not apply a voltage to the input terminals when no power supply voltage is applied to the IC. In addition, even if the power supply voltage is applied, apply to the input terminals a voltage lower than the power supply voltage or within the guaranteed value of electrical characteristics.

(10) Ground wiring pattern

If small-signal GND and large-current GND are provided, it will be recommended to separate the large-current GND pattern from the small-signal GND pattern and establish a single ground at the reference point of the set PCB so that resistance to the wiring pattern and voltage fluctuations due to a large current will cause no fluctuations in voltages of the small-signal GND. Pay attention not to cause fluctuations in the GND wiring pattern of external parts as well.

(11) External capacitor

In order to use a ceramic capacitor as the external capacitor, determine the constant with consideration given to a degradation in the nominal capacitance due to DC bias and changes in the capacitance due to temperature, etc.

(12) Thermal shutdown circuit (TSD)

When junction temperatures become 175°C (Typ.) or higher, the thermal shutdown circuit operates and turns a switch OFF. The thermal shutdown circuit, which is aimed at isolating the LSI from thermal runaway as much as possible, is not aimed at the protection or guarantee of the LSI. Therefore, do not continuously use the LSI with this circuit operating or use the LSI assuming its operation.

(13) Thermal design

Perform thermal design in which there are adequate margins by taking into account the permissible dissipation (Pd) in actual states of use.

(14) Selection of coil

Select the low DCR inductors to decrease power loss for DC/DC converter.

●Ordering Information

B D 6 5 B 6 0 G W L

E 2

Part Number

Package
GWL: UCSP50L1

Packaging and forming specification
E2: Embossed tape and reel

●Marking Diagram

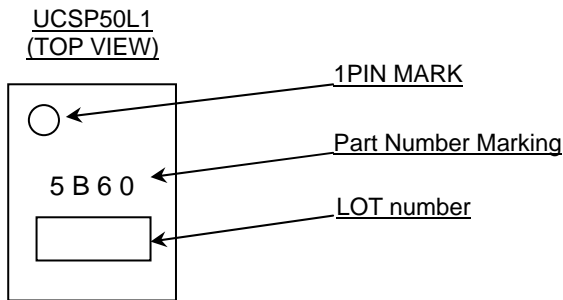

●Physical Dimension Tape and Reel Information

Package Name	UCSP50L1(BD65B60GWL)
--------------	----------------------

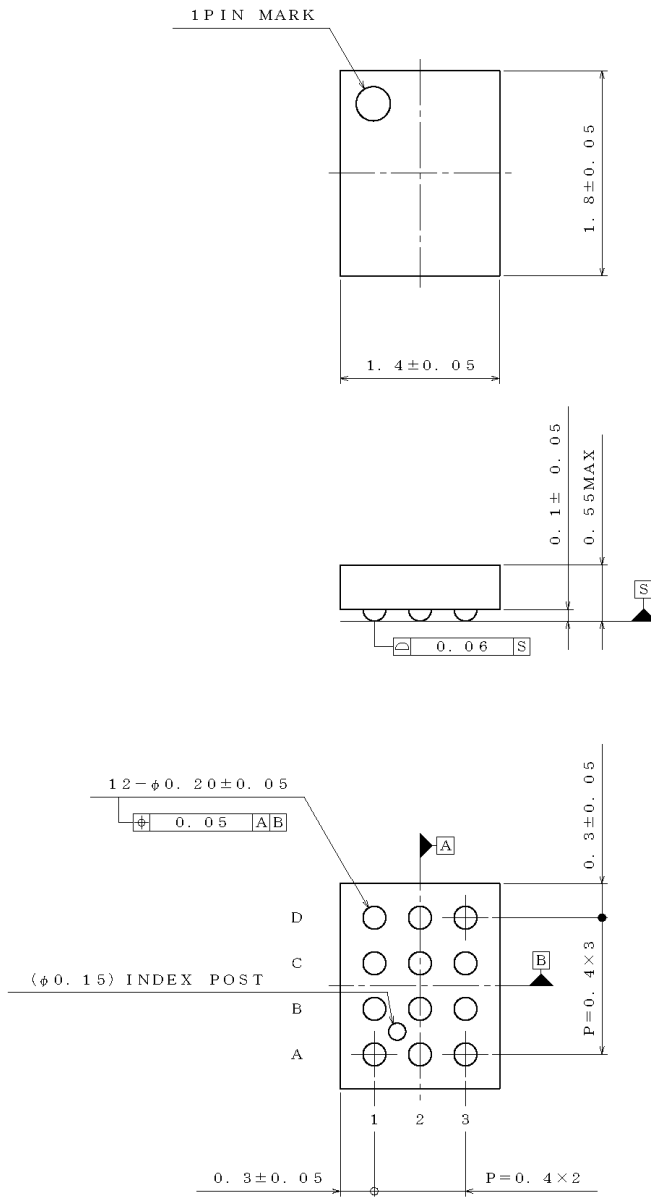

Drawing No : EX926-5021

(UNIT : mm)

< Tape and Reel Information >

Tape	Embossed carrier tape
Quantity	3000pcs/Reel
Direction of feed	E2 (The direction is the 1 pin of product is at the upper left when you hold reel on the left hand and you pull out the tape on the right hand)

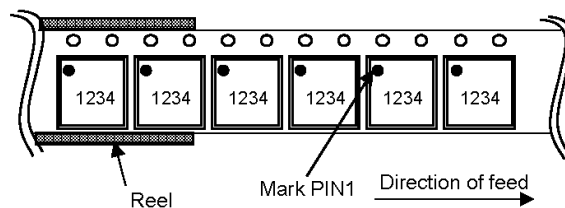

●Revision History

Date	Revision	Changes
3.Jun.2013	001	New Release

Notice

Precaution on using ROHM Products

- Our Products are designed and manufactured for application in ordinary electronic equipments (such as AV equipment, OA equipment, telecommunication equipment, home electronic appliances, amusement equipment, etc.). If you intend to use our Products in devices requiring extremely high reliability (such as medical equipment ^(Note 1), transport equipment, traffic equipment, aircraft/spacecraft, nuclear power controllers, fuel controllers, car equipment including car accessories, safety devices, etc.) and whose malfunction or failure may cause loss of human life, bodily injury or serious damage to property ("Specific Applications"), please consult with the ROHM sales representative in advance. Unless otherwise agreed in writing by ROHM in advance, ROHM shall not be in any way responsible or liable for any damages, expenses or losses incurred by you or third parties arising from the use of any ROHM's Products for Specific Applications.

(Note1) Medical Equipment Classification of the Specific Applications

JAPAN	USA	EU	CHINA
CLASS III	CLASS III	CLASS II b	CLASS III
CLASS IV		CLASS III	

- ROHM designs and manufactures its Products subject to strict quality control system. However, semiconductor products can fail or malfunction at a certain rate. Please be sure to implement, at your own responsibilities, adequate safety measures including but not limited to fail-safe design against the physical injury, damage to any property, which a failure or malfunction of our Products may cause. The following are examples of safety measures:
 - Installation of protection circuits or other protective devices to improve system safety
 - Installation of redundant circuits to reduce the impact of single or multiple circuit failure
- Our Products are designed and manufactured for use under standard conditions and not under any special or extraordinary environments or conditions, as exemplified below. Accordingly, ROHM shall not be in any way responsible or liable for any damages, expenses or losses arising from the use of any ROHM's Products under any special or extraordinary environments or conditions. If you intend to use our Products under any special or extraordinary environments or conditions (as exemplified below), your independent verification and confirmation of product performance, reliability, etc. prior to use, must be necessary:
 - Use of our Products in any types of liquid, including water, oils, chemicals, and organic solvents
 - Use of our Products outdoors or in places where the Products are exposed to direct sunlight or dust
 - Use of our Products in places where the Products are exposed to sea wind or corrosive gases, including Cl₂, H₂S, NH₃, SO₂, and NO₂
 - Use of our Products in places where the Products are exposed to static electricity or electromagnetic waves
 - Use of our Products in proximity to heat-producing components, plastic cords, or other flammable items
 - Sealing or coating our Products with resin or other coating materials
 - Use of our Products without cleaning residue of flux (even if you use no-clean type fluxes, cleaning residue of flux is recommended); or Washing our Products by using water or water-soluble cleaning agents for cleaning residue after soldering
 - Use of the Products in places subject to dew condensation
- The Products are not subject to radiation-proof design.
- Please verify and confirm characteristics of the final or mounted products in using the Products.
- In particular, if a transient load (a large amount of load applied in a short period of time, such as pulse. is applied, confirmation of performance characteristics after on-board mounting is strongly recommended. Avoid applying power exceeding normal rated power; exceeding the power rating under steady-state loading condition may negatively affect product performance and reliability.
- De-rate Power Dissipation (Pd) depending on Ambient temperature (Ta). When used in sealed area, confirm the actual ambient temperature.
- Confirm that operation temperature is within the specified range described in the product specification.
- ROHM shall not be in any way responsible or liable for failure induced under deviant condition from what is defined in this document.

Precaution for Mounting / Circuit board design

- When a highly active halogenous (chlorine, bromine, etc.) flux is used, the residue of flux may negatively affect product performance and reliability.
- In principle, the reflow soldering method must be used; if flow soldering method is preferred, please consult with the ROHM representative in advance.

For details, please refer to ROHM Mounting specification

Precautions Regarding Application Examples and External Circuits

1. If change is made to the constant of an external circuit, please allow a sufficient margin considering variations of the characteristics of the Products and external components, including transient characteristics, as well as static characteristics.
2. You agree that application notes, reference designs, and associated data and information contained in this document are presented only as guidance for Products use. Therefore, in case you use such information, you are solely responsible for it and you must exercise your own independent verification and judgment in the use of such information contained in this document. ROHM shall not be in any way responsible or liable for any damages, expenses or losses incurred by you or third parties arising from the use of such information.

Precaution for Electrostatic

This Product is electrostatic sensitive product, which may be damaged due to electrostatic discharge. Please take proper caution in your manufacturing process and storage so that voltage exceeding the Products maximum rating will not be applied to Products. Please take special care under dry condition (e.g. Grounding of human body / equipment / solder iron, isolation from charged objects, setting of ionizer, friction prevention and temperature / humidity control).

Precaution for Storage / Transportation

1. Product performance and soldered connections may deteriorate if the Products are stored in the places where:
 - [a] the Products are exposed to sea winds or corrosive gases, including Cl₂, H₂S, NH₃, SO₂, and NO₂
 - [b] the temperature or humidity exceeds those recommended by ROHM
 - [c] the Products are exposed to direct sunshine or condensation
 - [d] the Products are exposed to high Electrostatic
2. Even under ROHM recommended storage condition, solderability of products out of recommended storage time period may be degraded. It is strongly recommended to confirm solderability before using Products of which storage time is exceeding the recommended storage time period.
3. Store / transport cartons in the correct direction, which is indicated on a carton with a symbol. Otherwise bent leads may occur due to excessive stress applied when dropping of a carton.
4. Use Products within the specified time after opening a humidity barrier bag. Baking is required before using Products of which storage time is exceeding the recommended storage time period.

Precaution for Product Label

QR code printed on ROHM Products label is for ROHM's internal use only.

Precaution for Disposition

When disposing Products please dispose them properly using an authorized industry waste company.

Precaution for Foreign Exchange and Foreign Trade act

Since our Products might fall under controlled goods prescribed by the applicable foreign exchange and foreign trade act, please consult with ROHM representative in case of export.

Precaution Regarding Intellectual Property Rights

1. All information and data including but not limited to application example contained in this document is for reference only. ROHM does not warrant that foregoing information or data will not infringe any intellectual property rights or any other rights of any third party regarding such information or data. ROHM shall not be in any way responsible or liable for infringement of any intellectual property rights or other damages arising from use of such information or data.:
2. No license, expressly or implied, is granted hereby under any intellectual property rights or other rights of ROHM or any third parties with respect to the information contained in this document.

Other Precaution

1. This document may not be reprinted or reproduced, in whole or in part, without prior written consent of ROHM.
2. The Products may not be disassembled, converted, modified, reproduced or otherwise changed without prior written consent of ROHM.
3. In no event shall you use in any way whatsoever the Products and the related technical information contained in the Products or this document for any military purposes, including but not limited to, the development of mass-destruction weapons.
4. The proper names of companies or products described in this document are trademarks or registered trademarks of ROHM, its affiliated companies or third parties.

General Precaution

1. Before you use our Products, you are requested to carefully read this document and fully understand its contents. ROHM shall not be in any way responsible or liable for failure, malfunction or accident arising from the use of any ROHM's Products against warning, caution or note contained in this document.
2. All information contained in this document is current as of the issuing date and subject to change without any prior notice. Before purchasing or using ROHM's Products, please confirm the latest information with a ROHM sales representative.
3. The information contained in this document is provided on an "as is" basis and ROHM does not warrant that all information contained in this document is accurate and/or error-free. ROHM shall not be in any way responsible or liable for any damages, expenses or losses incurred by you or third parties resulting from inaccuracy or errors of or concerning such information.

Компания «Life Electronics» занимается поставками электронных компонентов импортного и отечественного производства от производителей и со складов крупных дистрибьюторов Европы, Америки и Азии.

С конца 2013 года компания активно расширяет линейку поставок компонентов по направлению коаксиальный кабель, кварцевые генераторы и конденсаторы (керамические, пленочные, электролитические), за счёт заключения дистрибьюторских договоров

Мы предлагаем:

- Конкуренспособные цены и скидки постоянным клиентам.
- Специальные условия для постоянных клиентов.
- Подбор аналогов.
- Поставку компонентов в любых объемах, удовлетворяющих вашим потребностям.
- Приемлемые сроки поставки, возможна ускоренная поставка.
- Доставку товара в любую точку России и стран СНГ.
- Комплексную поставку.
- Работу по проектам и поставку образцов.
- Формирование склада под заказчика.
- Сертификаты соответствия на поставляемую продукцию (по желанию клиента).
- Тестирование поставляемой продукции.
- Поставку компонентов, требующих военную и космическую приемку.
- Входной контроль качества.
- Наличие сертификата ISO.

В составе нашей компании организован Конструкторский отдел, призванный помогать разработчикам, и инженерам.

Конструкторский отдел помогает осуществить:

- Регистрацию проекта у производителя компонентов.
- Техническую поддержку проекта.
- Защиту от снятия компонента с производства.
- Оценку стоимости проекта по компонентам.
- Изготовление тестовой платы монтаж и пусконаладочные работы.



Тел: +7 (812) 336 43 04 (многоканальный)

Email: org@lifeelectronics.ru