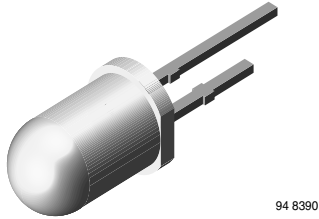


High Speed Infrared Emitting Diode, 850 nm, GaAlAs Double Hetero



DESCRIPTION

TSHG5210 is an infrared, 850 nm emitting diode in GaAlAs double hetero (DH) technology with high radiant power and high speed, molded in a clear, untinted plastic package.

FEATURES

- Package type: leaded
- Package form: T-1 $\frac{3}{4}$
- Dimensions (in mm): \varnothing 5
- Leads with stand-off
- Peak wavelength: $\lambda_p = 850$ nm
- High reliability
- High radiant power
- High radiant intensity
- Angle of half intensity: $\varphi = \pm 10^\circ$
- Low forward voltage
- Suitable for high pulse current operation
- High modulation bandwidth: $f_c = 18$ MHz
- Good spectral matching with CMOS cameras
- Compliant to RoHS directive 2002/95/EC and in accordance to WEEE 2002/96/EC
- Halogen-free according to IEC 61249-2-21 definition



RoHS
COMPLIANT
HALOGEN
FREE

APPLICATIONS

- Infrared radiation source for operation with CMOS cameras
- High speed IR data transmission
- Smoke-automatic fire detectors

PRODUCT SUMMARY

COMPONENT	I_e (mW/sr)	φ (deg)	λ_p (nm)	t_r (ns)
TSHG5210	230	± 10	850	20

Note

Test conditions see table "Basic Characteristics"

ORDERING INFORMATION

ORDERING CODE	PACKAGING	REMARKS	PACKAGE FORM
TSHG5210	Bulk	MOQ: 4000 pcs, 4000 pcs/bulk	T-1 $\frac{3}{4}$

Note

MOQ: minimum order quantity

ABSOLUTE MAXIMUM RATINGS

PARAMETER	TEST CONDITION	SYMBOL	VALUE	UNIT
Reverse voltage		V_R	5	V
Forward current		I_F	100	mA
Peak forward current	$t_p/T = 0.5, t_p = 100 \mu s$	I_{FM}	200	mA
Surge forward current	$t_p = 100 \mu s$	I_{FSM}	1	A
Power dissipation		P_V	180	mW
Junction temperature		T_j	100	$^\circ C$
Operating temperature range		T_{amb}	- 40 to + 85	$^\circ C$
Storage temperature range		T_{stg}	- 40 to + 100	$^\circ C$
Soldering temperature	$t \leq 5$ s, 2 mm from case	T_{sd}	260	$^\circ C$
Thermal resistance junction/ambient	J-STD-051, leads 7 mm, soldered on PCB	R_{thJA}	230	K/W

Note

$T_{amb} = 25 \text{ }^\circ C$, unless otherwise specified

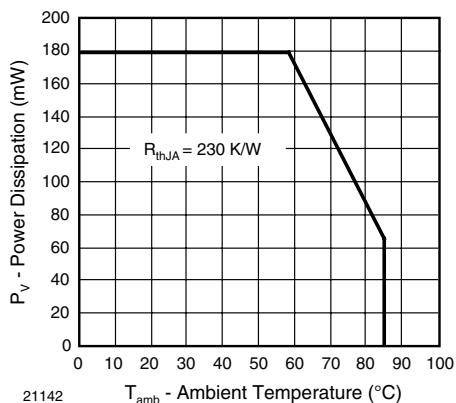


Fig. 1 - Power Dissipation Limit vs. Ambient Temperature

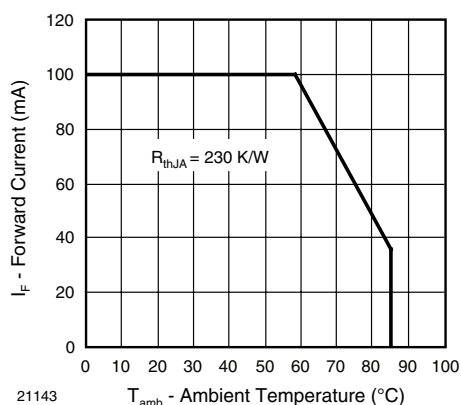


Fig. 2 - Forward Current Limit vs. Ambient Temperature

BASIC CHARACTERISTICS						
PARAMETER	TEST CONDITION	SYMBOL	MIN.	TYP.	MAX.	UNIT
Forward voltage	I _F = 100 mA, t _p = 20 ms	V _F		1.5	1.8	V
	I _F = 1 A, t _p = 100 μs	V _F		2.3		V
Temperature coefficient of V _F	I _F = 1 mA	TK _{V_F}		- 1.8		mV/K
Reverse current	V _R = 5 V	I _R			10	μA
Junction capacitance	V _R = 0 V, f = 1 MHz, E = 0	C _j		125		pF
Radiant intensity	I _F = 100 mA, t _p = 20 ms	I _e	140	230	420	mW/sr
	I _F = 1 A, t _p = 100 μs	I _e		2300		mW/sr
Radiant power	I _F = 100 mA, t _p = 20 ms	φ _e		55		mW
Temperature coefficient of φ _e	I _F = 100 mA	TKφ _e		- 0.35		%/K
Angle of half intensity		φ		± 10		deg
Peak wavelength	I _F = 100 mA	λ _p	820	850	880	nm
Spectral bandwidth	I _F = 100 mA	Δλ		40		nm
Temperature coefficient of λ _p	I _F = 100 mA	TKλ _p		0.25		nm/K
Rise time	I _F = 100 mA	t _r		20		ns
Fall time	I _F = 100 mA	t _f		13		ns
Cut-off frequency	I _{DC} = 70 mA, I _{AC} = 30 mA pp	f _c		18		MHz
Virtual source diameter		d		3.7		mm

Note

T_{amb} = 25 °C, unless otherwise specified

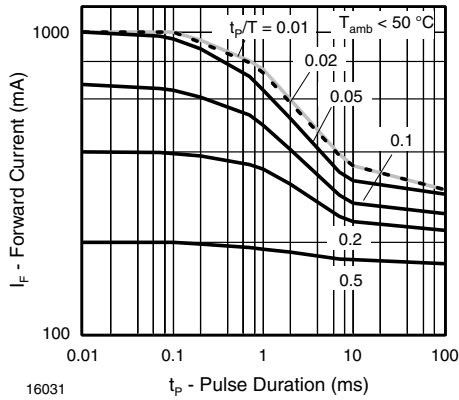
BASIC CHARACTERISTICS
 $T_{amb} = 25\text{ }^{\circ}\text{C}$, unless otherwise specified


Fig. 3 - Pulse Forward Current vs. Pulse Duration

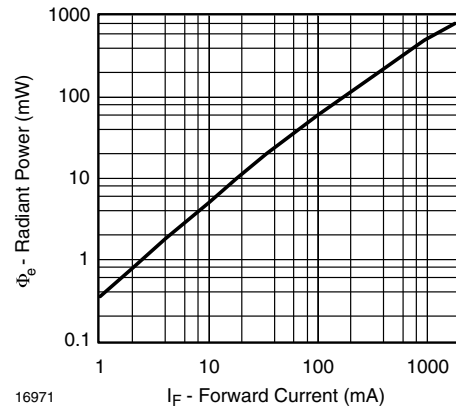


Fig. 6 - Radiant Power vs. Forward Current

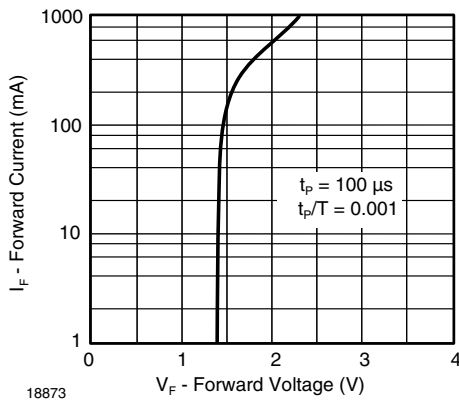


Fig. 4 - Forward Current vs. Forward Voltage

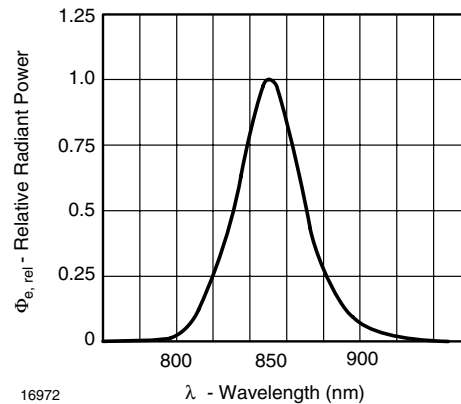


Fig. 7 - Relative Radiant Power vs. Wavelength

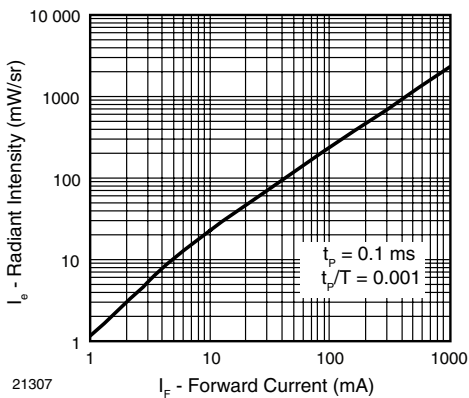


Fig. 5 - Radiant Intensity vs. Forward Current

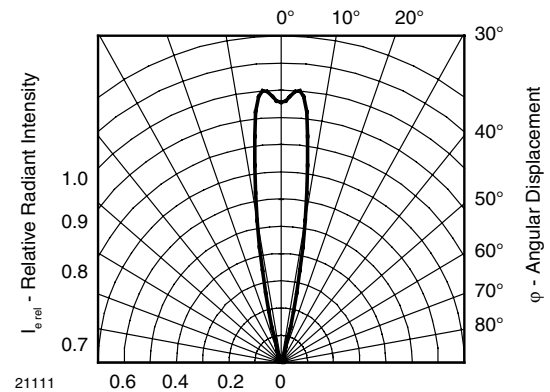


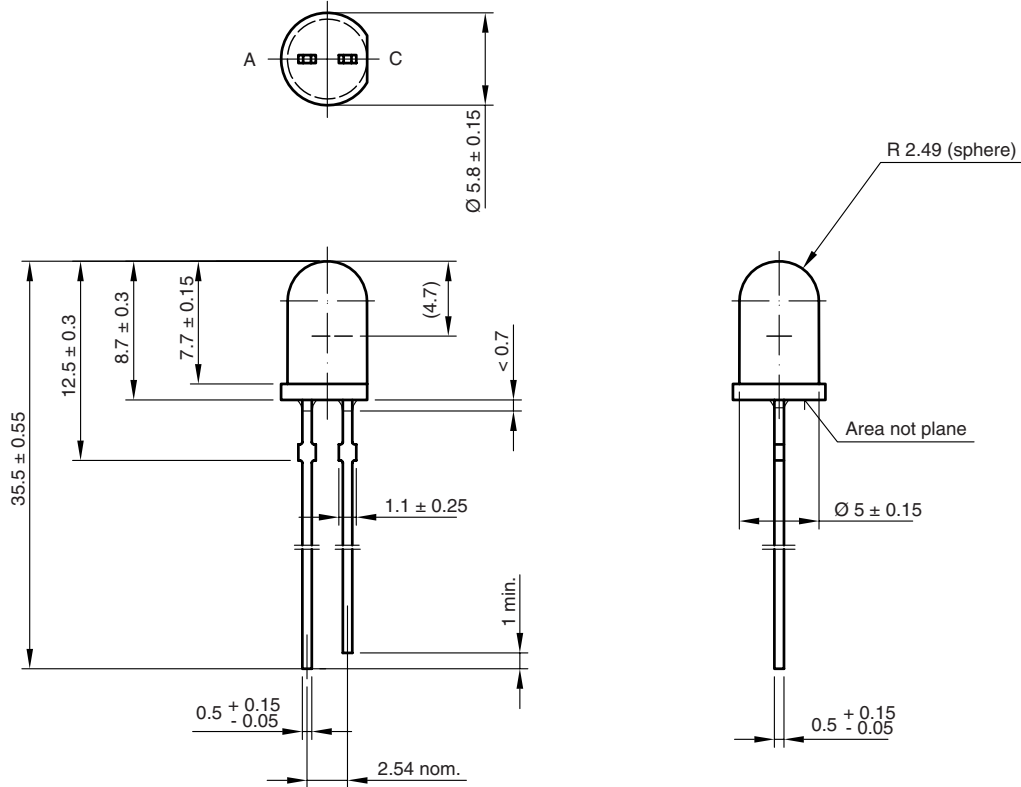
Fig. 8 - Relative Radiant Intensity vs. Angular Displacement

TSHG5210

Vishay Semiconductors High Speed Infrared Emitting Diode,
850 nm, GaAlAs Double Hetero



PACKAGE DIMENSIONS in millimeters



6.544-5258.02-4
Issue: 6; 19.05.09
95 10916



Disclaimer

ALL PRODUCT, PRODUCT SPECIFICATIONS AND DATA ARE SUBJECT TO CHANGE WITHOUT NOTICE TO IMPROVE RELIABILITY, FUNCTION OR DESIGN OR OTHERWISE.

Vishay Intertechnology, Inc., its affiliates, agents, and employees, and all persons acting on its or their behalf (collectively, "Vishay"), disclaim any and all liability for any errors, inaccuracies or incompleteness contained in any datasheet or in any other disclosure relating to any product.

Vishay makes no warranty, representation or guarantee regarding the suitability of the products for any particular purpose or the continuing production of any product. To the maximum extent permitted by applicable law, Vishay disclaims (i) any and all liability arising out of the application or use of any product, (ii) any and all liability, including without limitation special, consequential or incidental damages, and (iii) any and all implied warranties, including warranties of fitness for particular purpose, non-infringement and merchantability.

Statements regarding the suitability of products for certain types of applications are based on Vishay's knowledge of typical requirements that are often placed on Vishay products in generic applications. Such statements are not binding statements about the suitability of products for a particular application. It is the customer's responsibility to validate that a particular product with the properties described in the product specification is suitable for use in a particular application. Parameters provided in datasheets and/or specifications may vary in different applications and performance may vary over time. All operating parameters, including typical parameters, must be validated for each customer application by the customer's technical experts. Product specifications do not expand or otherwise modify Vishay's terms and conditions of purchase, including but not limited to the warranty expressed therein.

Except as expressly indicated in writing, Vishay products are not designed for use in medical, life-saving, or life-sustaining applications or for any other application in which the failure of the Vishay product could result in personal injury or death. Customers using or selling Vishay products not expressly indicated for use in such applications do so at their own risk and agree to fully indemnify and hold Vishay and its distributors harmless from and against any and all claims, liabilities, expenses and damages arising or resulting in connection with such use or sale, including attorneys fees, even if such claim alleges that Vishay or its distributor was negligent regarding the design or manufacture of the part. Please contact authorized Vishay personnel to obtain written terms and conditions regarding products designed for such applications.

No license, express or implied, by estoppel or otherwise, to any intellectual property rights is granted by this document or by any conduct of Vishay. Product names and markings noted herein may be trademarks of their respective owners.

Компания «Life Electronics» занимается поставками электронных компонентов импортного и отечественного производства от производителей и со складов крупных дистрибьюторов Европы, Америки и Азии.

С конца 2013 года компания активно расширяет линейку поставок компонентов по направлению коаксиальный кабель, кварцевые генераторы и конденсаторы (керамические, пленочные, электролитические), за счёт заключения дистрибьюторских договоров

Мы предлагаем:

- Конкурентоспособные цены и скидки постоянным клиентам.
- Специальные условия для постоянных клиентов.
- Подбор аналогов.
- Поставку компонентов в любых объемах, удовлетворяющих вашим потребностям.
- Приемлемые сроки поставки, возможна ускоренная поставка.
- Доставку товара в любую точку России и стран СНГ.
- Комплексную поставку.
- Работу по проектам и поставку образцов.
- Формирование склада под заказчика.
- Сертификаты соответствия на поставляемую продукцию (по желанию клиента).
- Тестирование поставляемой продукции.
- Поставку компонентов, требующих военную и космическую приемку.
- Входной контроль качества.
- Наличие сертификата ISO.

В составе нашей компании организован Конструкторский отдел, призванный помогать разработчикам, и инженерам.

Конструкторский отдел помогает осуществить:

- Регистрацию проекта у производителя компонентов.
- Техническую поддержку проекта.
- Защиту от снятия компонента с производства.
- Оценку стоимости проекта по компонентам.
- Изготовление тестовой платы монтаж и пусконаладочные работы.



Тел: +7 (812) 336 43 04 (многоканальный)

Email: org@lifeelectronics.ru